

Protection Device

TVS (Transient Voltage Suppressor)

ESD110-B1 Series

Bi-directional, 18.5 V (AC), 0.3 pF, 0201, 0402, RoHS and Halogen Free compliant

ESD110-B1-02ELS
ESD110-B1-02EL

Data Sheet

Revision 1.4, 2014-10-23
Final

Edition 2014-10-23

Published by

Infineon Technologies AG

81726 Munich, Germany

© 2014 Infineon Technologies AG

All Rights Reserved.

Information

For further information on technology, delivery terms and conditions and prices, please contact the nearest Infineon Technologies Office (www.infineon.com)

Warnings

Due to technical requirements, components may contain dangerous substances. For information on the types in question, please contact the nearest Infineon Technologies Office.

Infineon Technologies components may be used in life-support devices or systems only with the express written approval of Infineon Technologies, if a failure of such components can reasonably be expected to cause the failure of that life-support device or system or to affect the safety or effectiveness of that device or system. Life support devices or systems are intended to be implanted in the human body or to support and/or maintain and sustain and/or protect human life. If they fail, it is reasonable to assume that the health of the user or other persons may be endangered.

1 Product Overview

1.1 Features

- ESD / transient protection according to:
 - IEC61000-4-2 (ESD): ± 15 kV (air), ± 12 kV (contact)
 - IEC61000-4-5 (Surge): ± 2 A ($t_p = 8 / 20 \mu s$)
- Bi-directional, working voltage up to $V_{RWM} = \pm 18.5$ V (AC)
- Ultra-low capacitance: $C_L = 0.3$ pF (typical)
- Low clamping voltage: $V_{CL} = 28$ V (typical) at $I_{TLP} = 16$ A
- Very low reverse current: $I_R < 1$ nA (typical)
- Pb-free (RoHS compliant) and halogen free package



1.2 Application Examples

- ESD Protection of RF signal lines in Near Field Communication (NFC) applications

1.3 Product Description

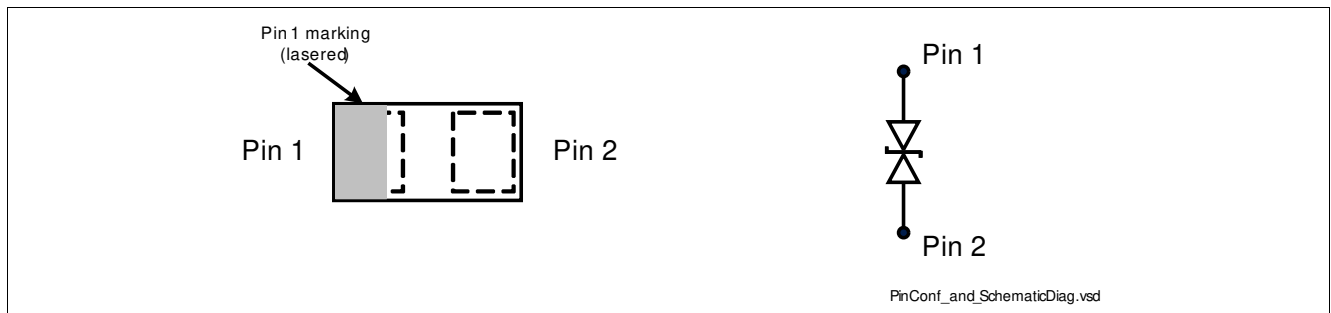

Figure 1-1 Pin Configuration and Schematic Diagram

Table 1-1 Part Information

Type	Package	Configuration	Marking code
ESD110-B1-02ELS	TSSLP-2-4	1 line, bi-directional	X
ESD110-B1-02EL	TSLP-2-20	1 line, bi-directional	XX

2 Maximum Ratings

Table 2-1 Maximum Ratings at $T_A = 25\text{ °C}$, unless otherwise specified¹⁾

Parameter	Symbol	Values	Unit
ESD air discharge ²⁾	V_{ESD}	±15	kV
ESD contact discharge ²⁾		±12	
Peak pulse power ³⁾	P_{PK}	58	W
Peak pulse current ³⁾	I_{PP}	±2	A
Operating temperature	T_{OP}	-40 to 125	°C
Storage temperature	T_{stg}	-55 to 150	°C

- 1) Device is electrically symmetrical
- 2) V_{ESD} according to IEC61000-4-2
- 3) Non-repetitive current pulse 8/20µs exponential decay waveform according to IEC61000-4-5

Attention: Stresses above the max. values listed here may cause permanent damage to the device. Exposure to absolute maximum rating conditions for extended periods may affect device reliability. Maximum ratings are absolute ratings; exceeding only one of these values may cause irreversible damage to the integrated circuit.

3 Electrical Characteristics at $T_A = 25\text{ °C}$, unless otherwise specified

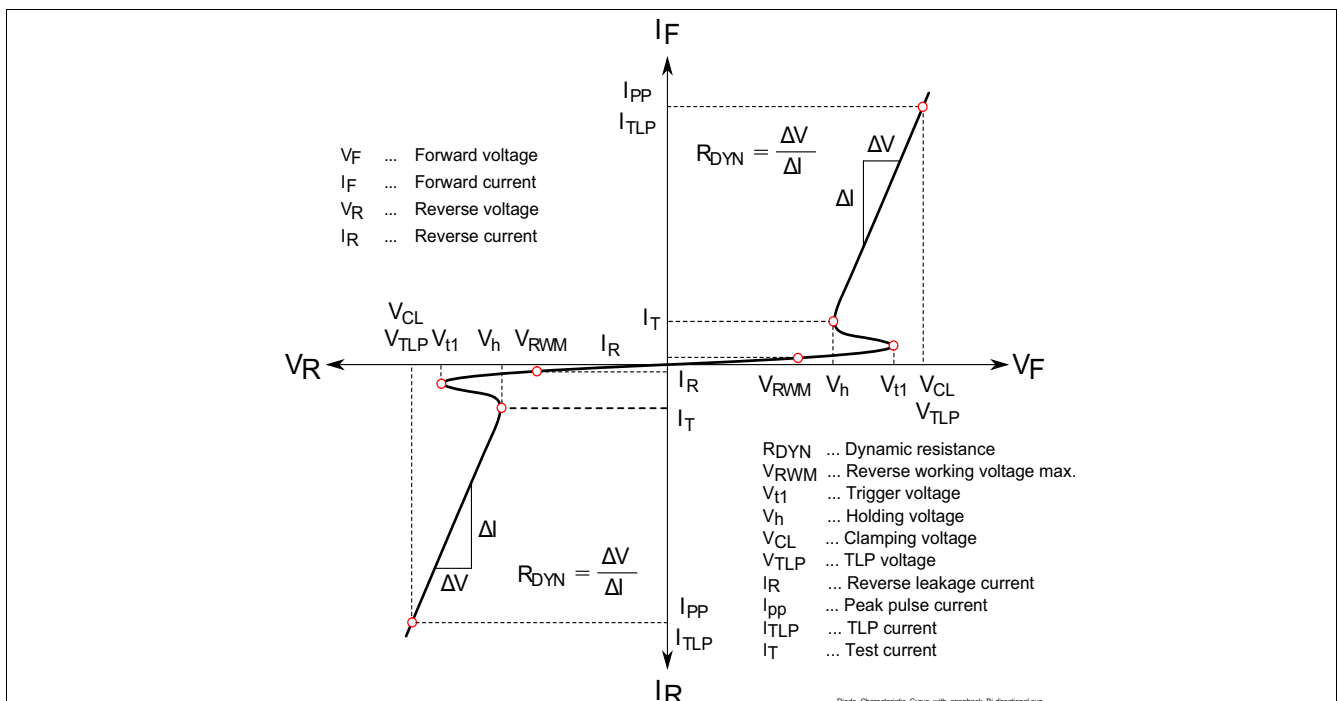

Figure 3-1 Definitions of electrical characteristics

Electrical Characteristics at $T_A = 25\text{ }^\circ\text{C}$, unless otherwise specified
Table 3-1 DC Characteristics at $T_A = 25\text{ }^\circ\text{C}$, unless otherwise specified¹⁾

Parameter	Symbol	Values			Unit	Note / Test Condition
		Min.	Typ.	Max.		
Reverse working voltage	V_{RWM}	-18.5	–	18.5	V	for AC voltages (NFC)
		-15	–	15		for DC voltages
Trigger voltage	V_{t1}	20	–	–	V	
Holding voltage	V_h	20	21	26	V	$T_A = 25\text{ }^\circ\text{C}$, $I_T = 0.5\text{ mA}$
		–	19	–		$T_A = 125\text{ }^\circ\text{C}$, $I_T = 0.5\text{ mA}$
Reverse leakage current	I_R	–	<1	30	nA	$T_A = 25\text{ }^\circ\text{C}$, $V_R = 18.5\text{ V}$
		–	10	–		$T_A = 125\text{ }^\circ\text{C}$, $V_R = 18.5\text{ V}$

1) Device is electrically symmetrical

Table 3-2 AC Characteristics at $T_A = 25\text{ }^\circ\text{C}$, unless otherwise specified

Parameter	Symbol	Values			Unit	Note / Test Condition
		Min.	Typ.	Max.		
Line capacitance	C_L	0.15	0.3	0.5	pF	$V_R = 0\text{ V}$, $f = 1\text{ MHz}$
		0.15	0.3	0.5		$V_R = 0\text{ V}$, $f = 1\text{ GHz}$
Serie inductance	L_S	–	0.2	–	nH	ESD110-B1-02ELS
		–	0.4	–		ESD110-B1-02EL

Table 3-3 ESD and Surge Characteristics at $T_A = 25\text{ }^\circ\text{C}$, unless otherwise specified¹⁾

Parameter	Symbol	Values			Unit	Note / Test Condition
		Min.	Typ.	Max.		
Clamping voltage ²⁾	V_{CL}	–	30	35	V	$I_{TLP} = 16\text{ A}$, $t_p = 100\text{ ns}$
		–	39	44		$I_{TLP} = 30\text{ A}$, $t_p = 100\text{ ns}$
Clamping voltage ³⁾	V_{CL}	–	19	24		$I_{PP} = 1\text{ A}$, $t_p = 8/20\text{ }\mu\text{s}$
		–	24	29		$I_{PP} = 2\text{ A}$, $t_p = 8/20\text{ }\mu\text{s}$
Dynamic resistance ²⁾	R_{DYN}	–	0.6	–	Ω	$t_p = 100\text{ ns}$

1) Device is electrically symmetrical

2) Please refer to Application Note AN210[1]. TLP parameter: $Z_0 = 50\text{ }\Omega$, $t_p = 100\text{ ns}$, $t_r = 300\text{ ps}$

3) Non-repetitive current pulse 8/20 μs exponential decay waveform according to IEC61000-4-5

4 Typical Characteristics Diagrams

Typical characteristics diagrams at $T_A=25^\circ\text{C}$, unless otherwise specified

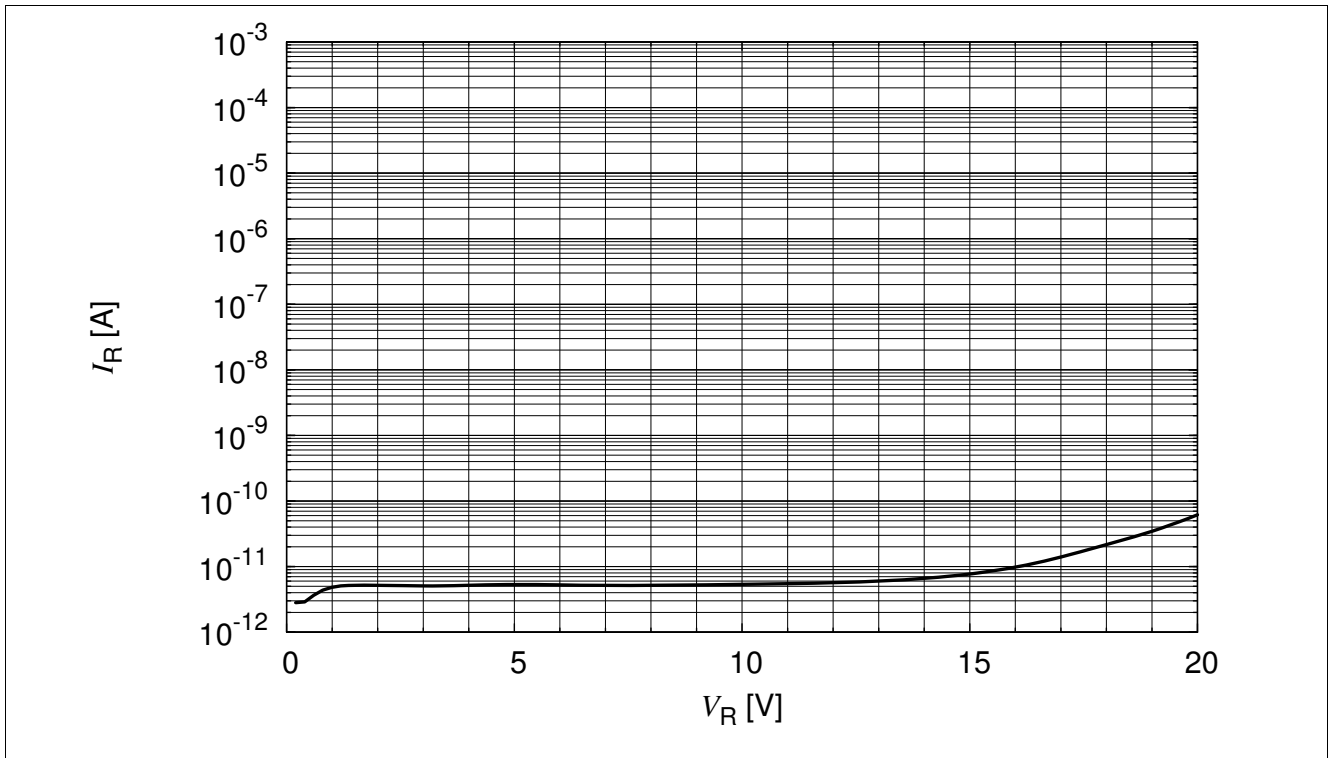

Figure 4-1 Reverse leakage current: $I_R = f(V_R)$

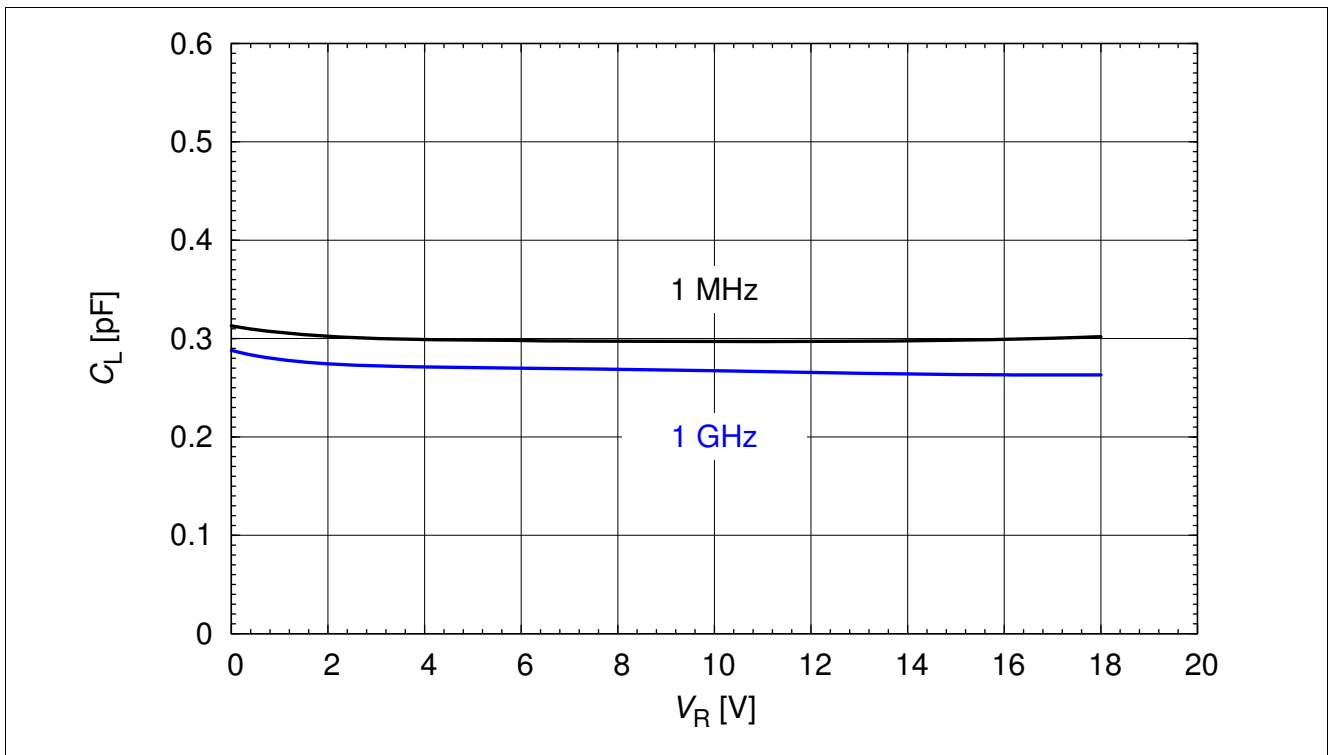

Figure 4-2 Line capacitance: $C_L = f(V_R)$

Typical Characteristics Diagrams

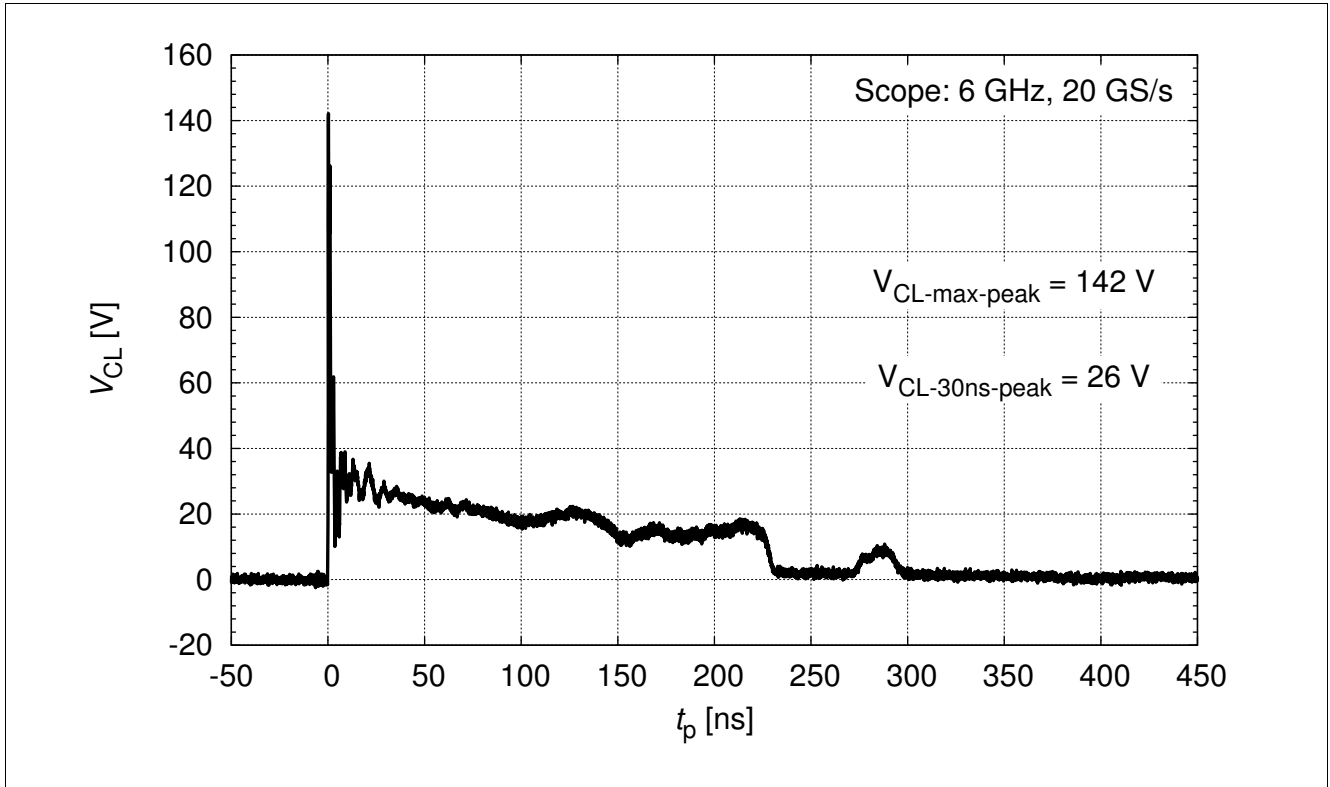

Figure 4-3 Clamping voltage (ESD): $V_{CL} = f(t)$, 8 kV positiv pulse from pin 1 to pin 2

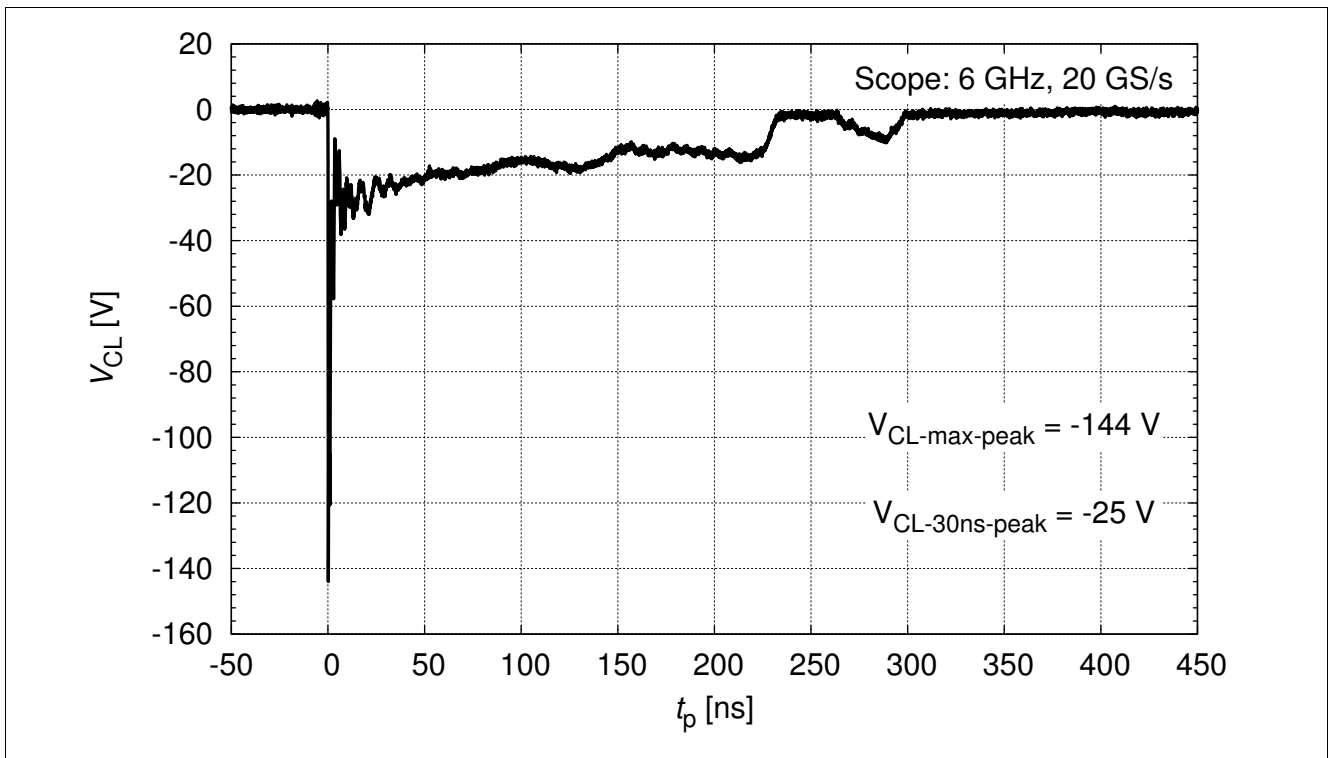

Figure 4-4 Clamping voltage (ESD): $V_{CL} = f(t)$, 8 kV negativ pulse from pin 1 to pin 2

Typical Characteristics Diagrams

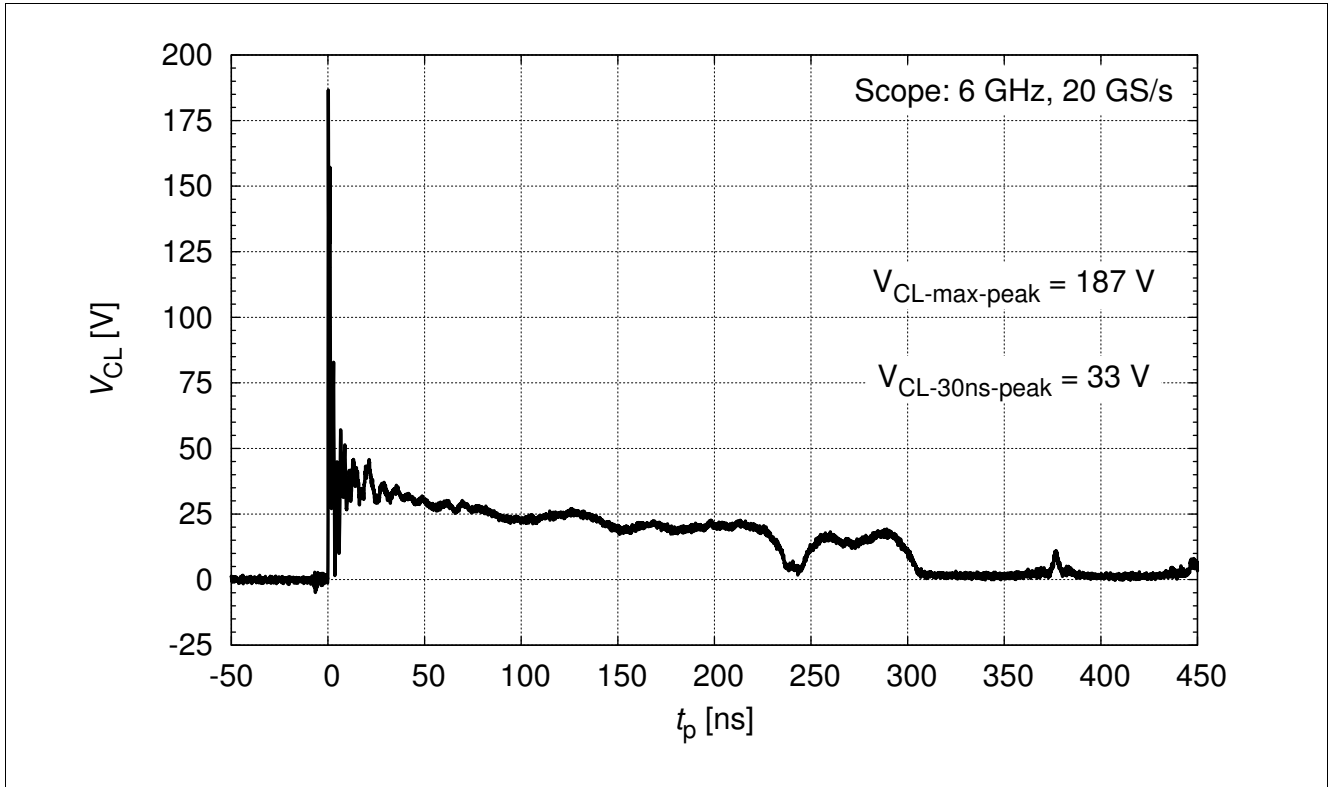

Figure 4-5 Clamping voltage (ESD): $V_{CL} = f(t)$, 15 kV positiv pulse from pin 1 to pin 2

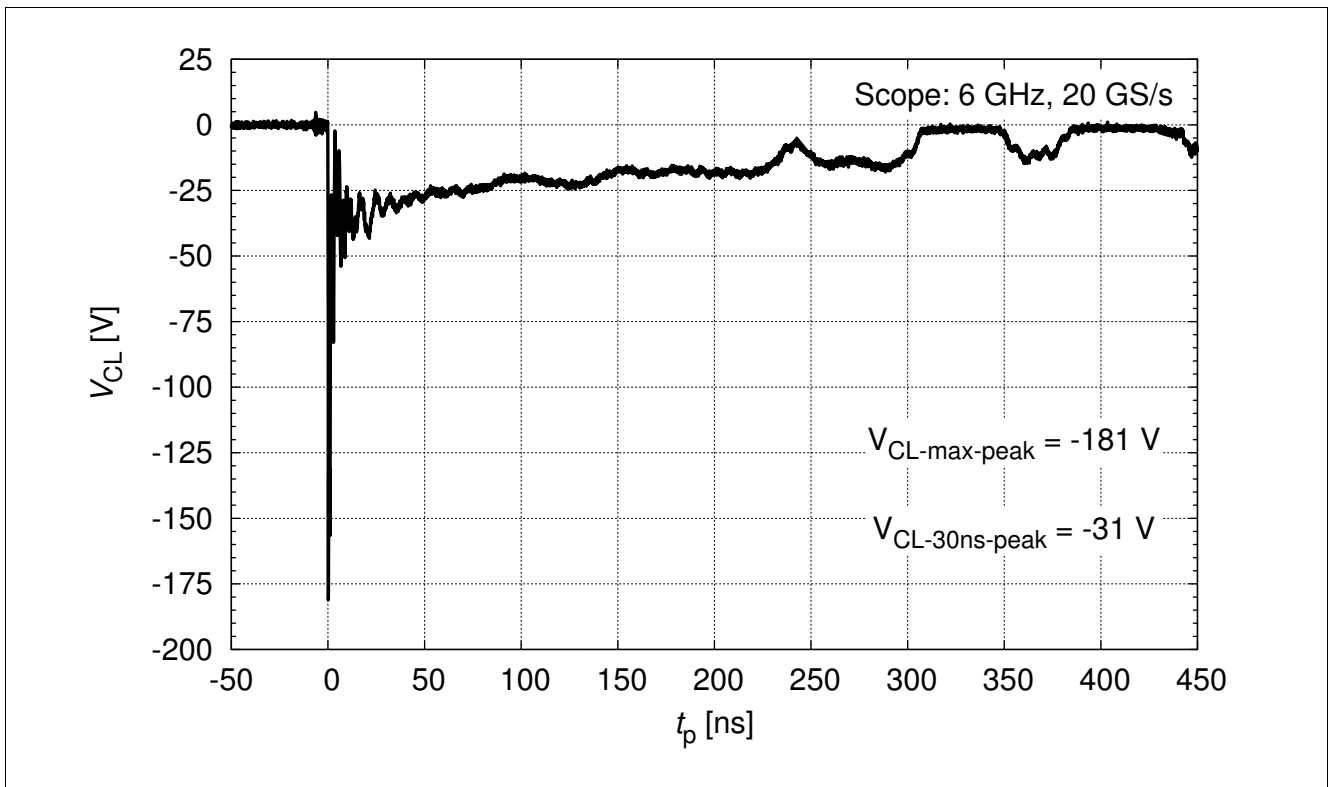

Figure 4-6 Clamping voltage (ESD): $V_{CL} = f(t)$, 15 kV negativ pulse from pin 1 to pin 2

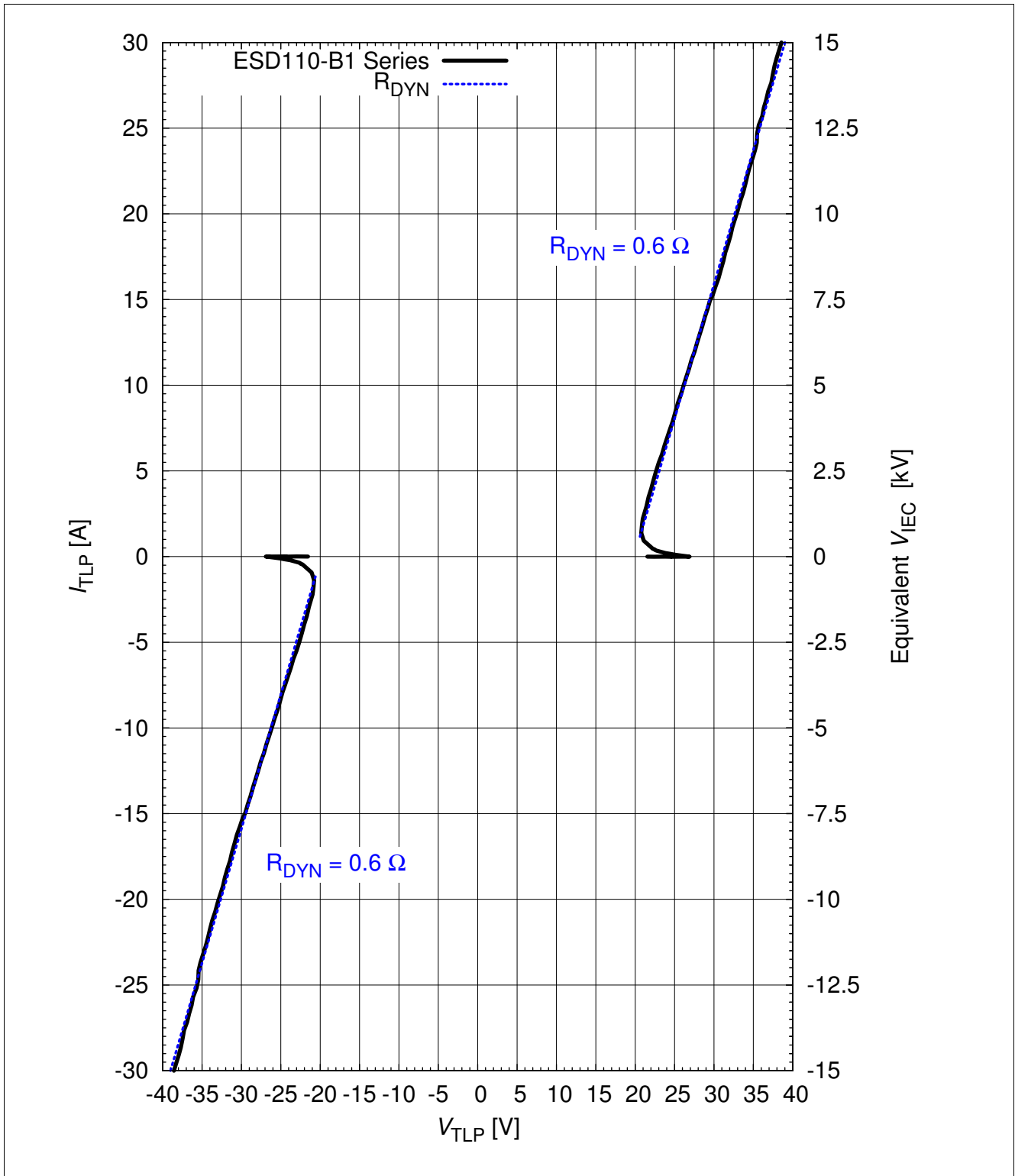

Figure 4-7 Clamping voltage (TLP): $I_{TLP} = f(V_{TLP})$ [1], pin 1 to pin 2

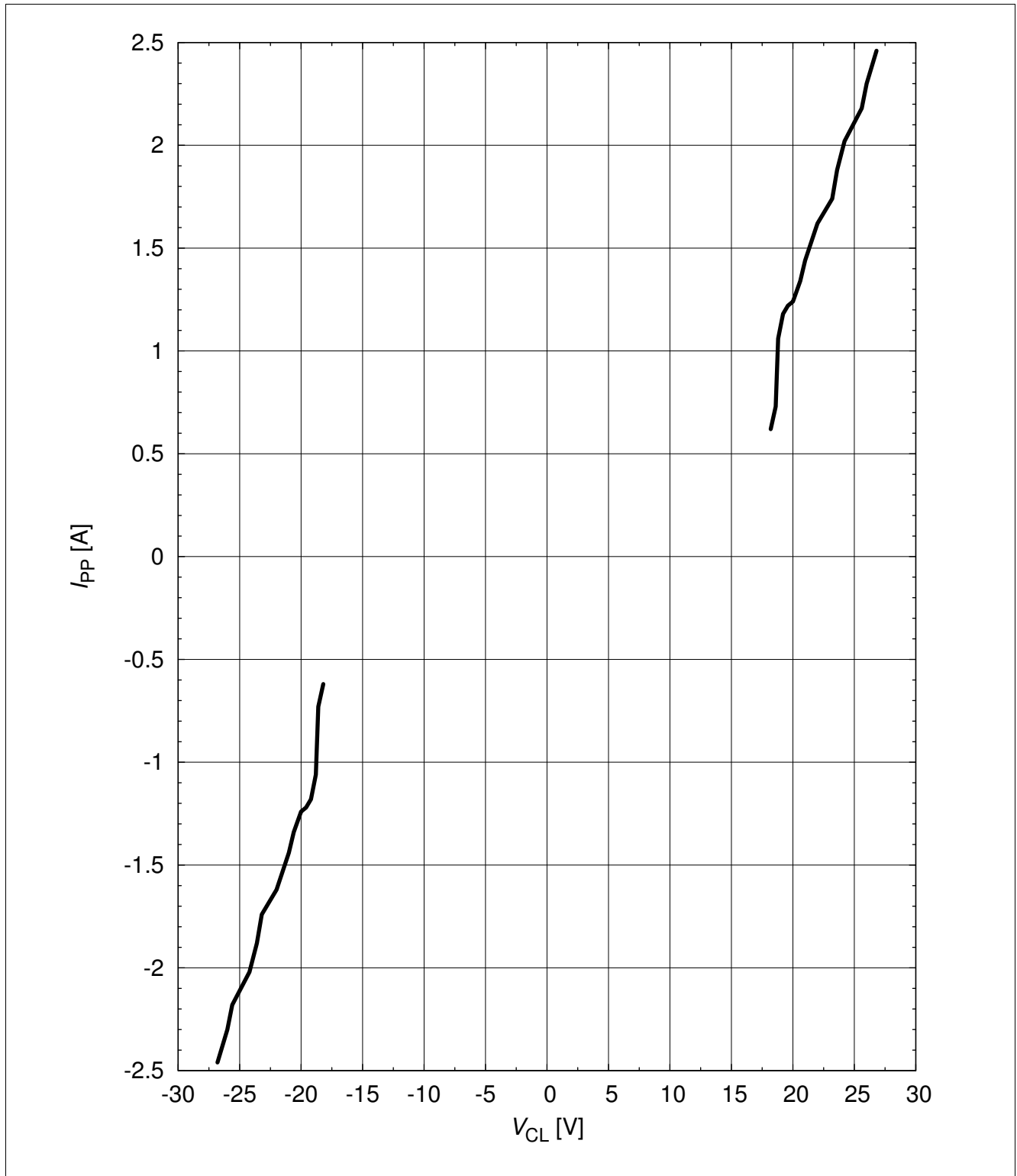

Figure 4-8 Clamping voltage(Surge): $I_{PP} = f(V_{CL})$

Typical Characteristics Diagrams

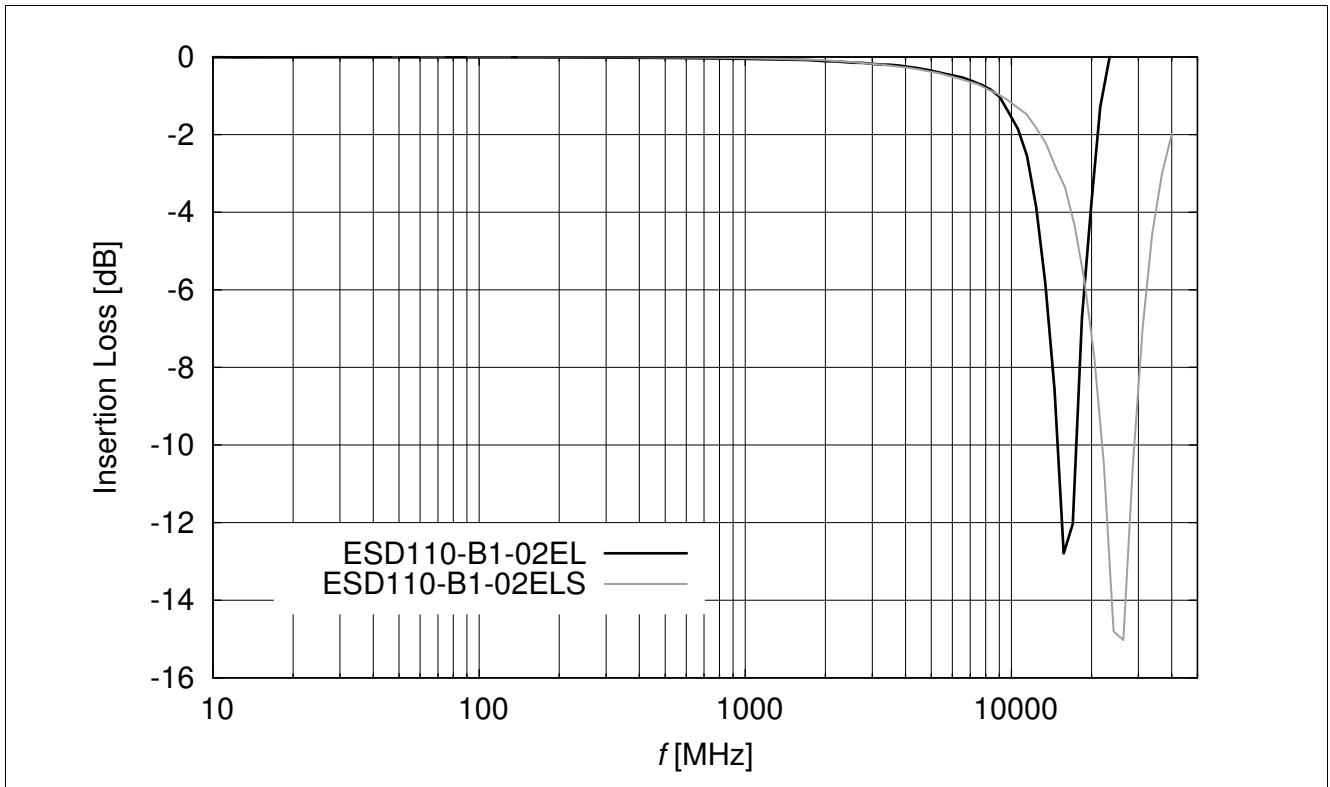

Figure 4-9 Insertion loss vs. frequency in a 50 Ω system

5 Application Information

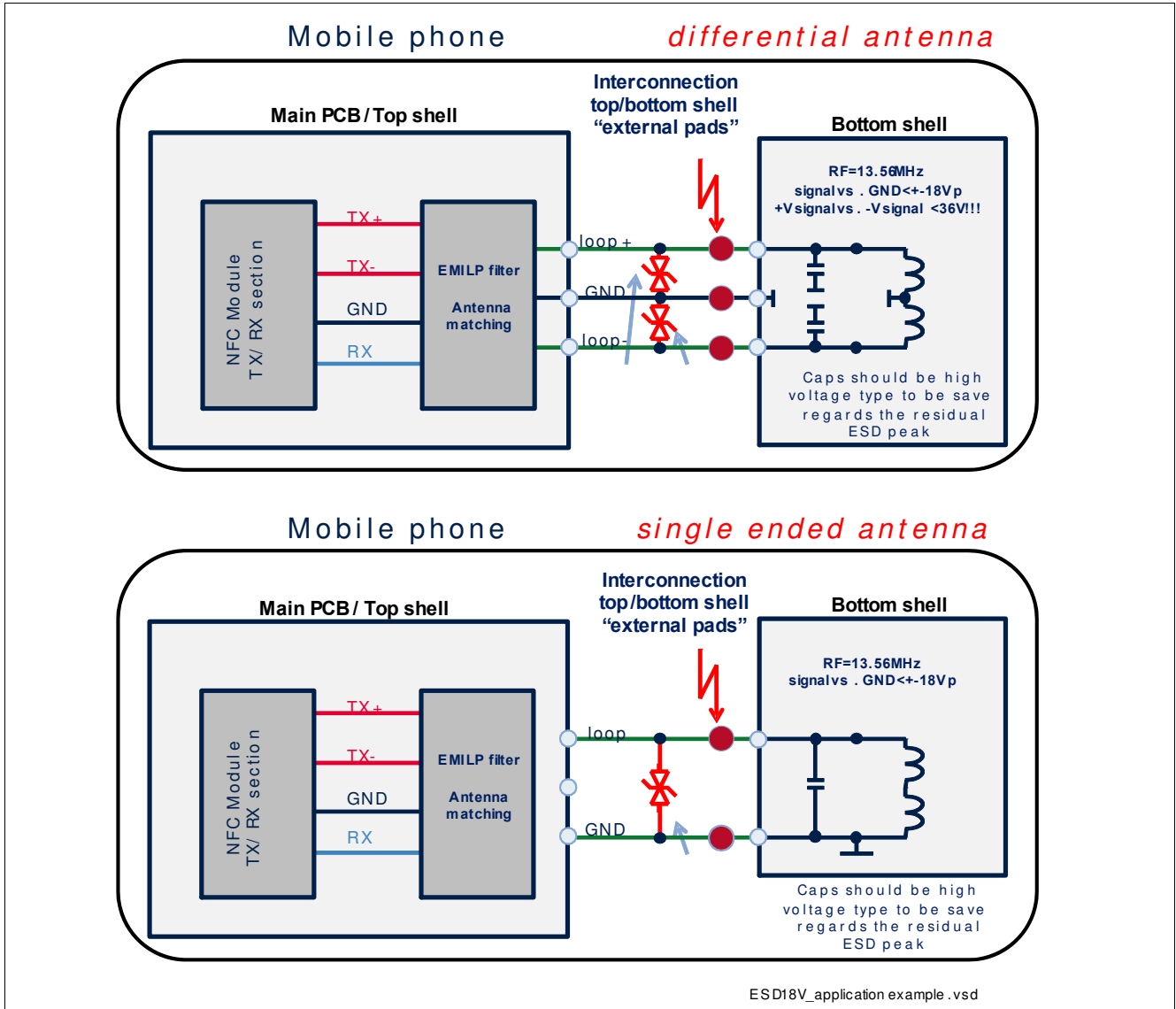

Figure 5-1 Bi-directional ESD / Transient protection for NFC Frontend [3]

6 Package Information

6.1 TSSLP-2-4

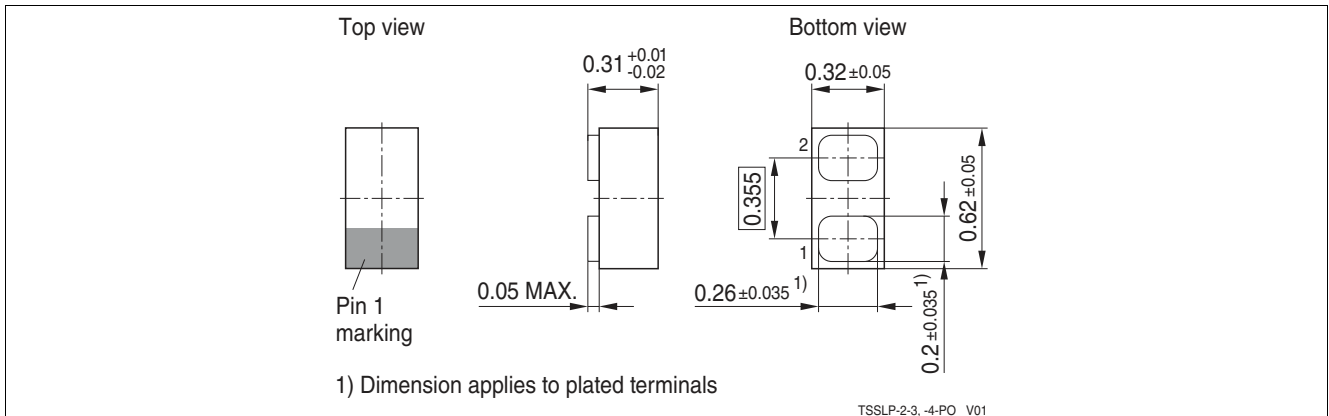

Figure 6-1 TSSLP-2-4: Package outline

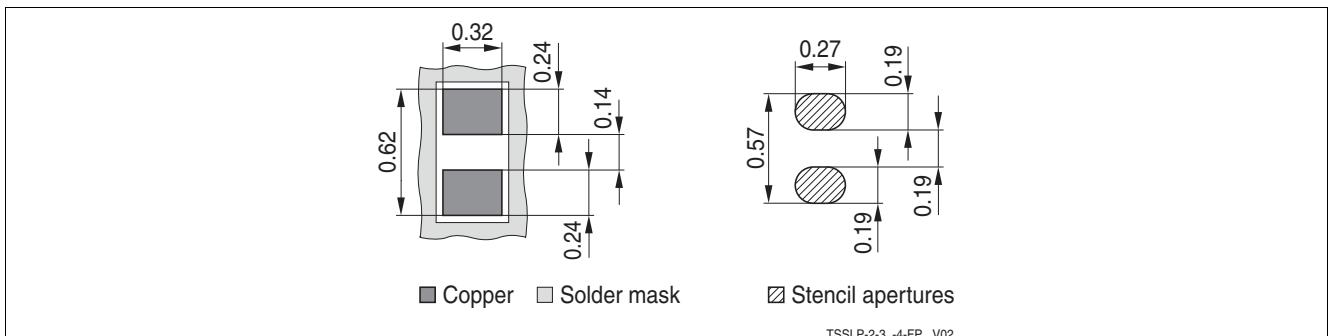

Figure 6-2 TSSLP-2-4: Footprint

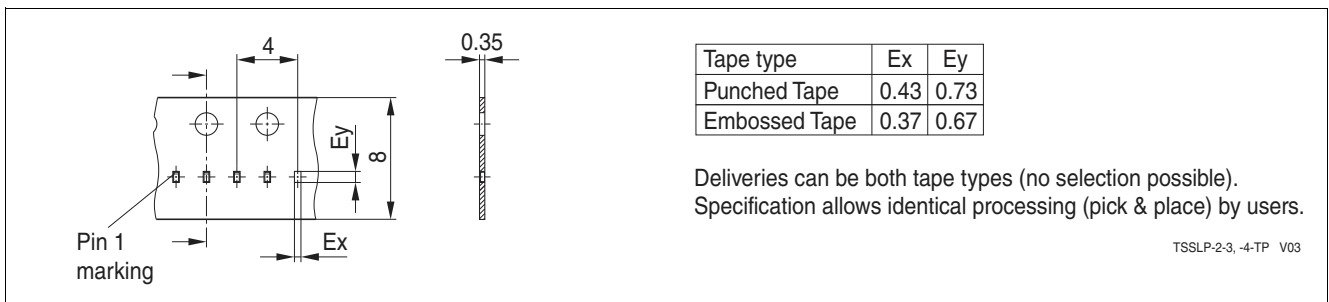

Figure 6-3 TSSLP-2-4: Packing

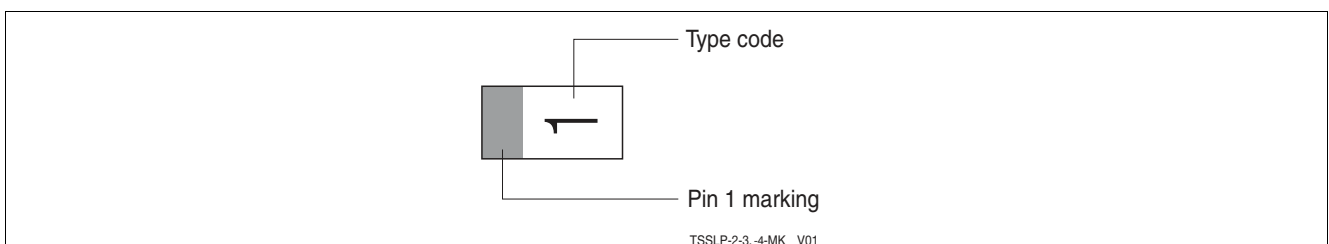

Figure 6-4 TSSLP-2-4: Marking (example) [Table 1-1 "Part Information" on Page 3](#)

6.2 TSLP-2-20

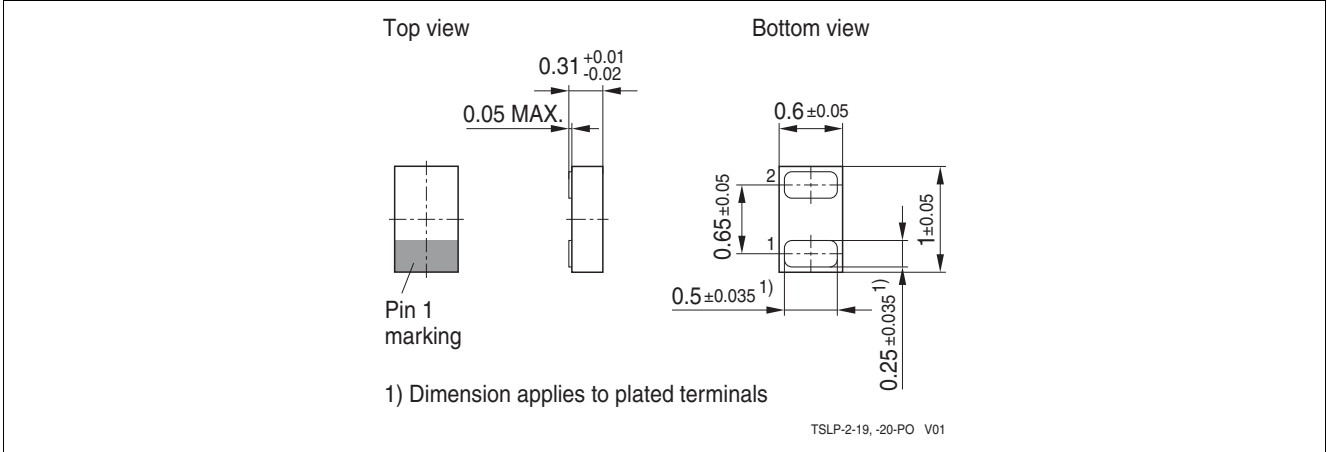

Figure 6-5 TSLP-2-20: Package overview

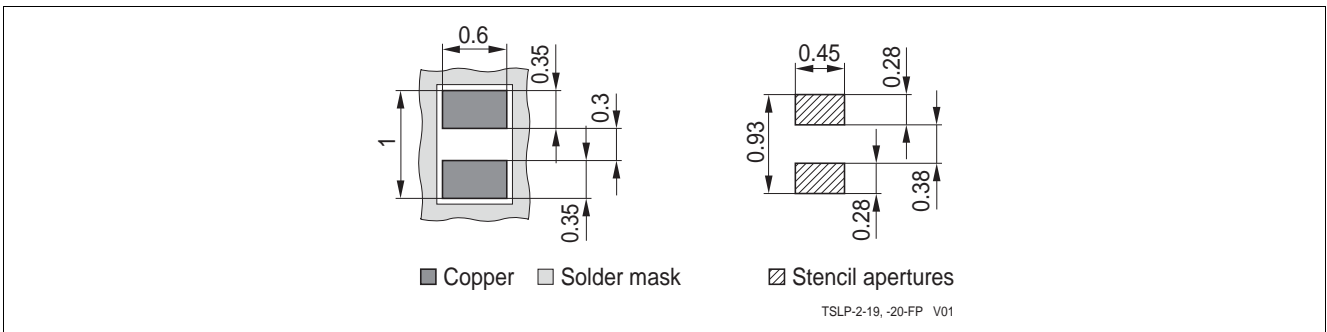

Figure 6-6 TSLP-2-20: Footprint

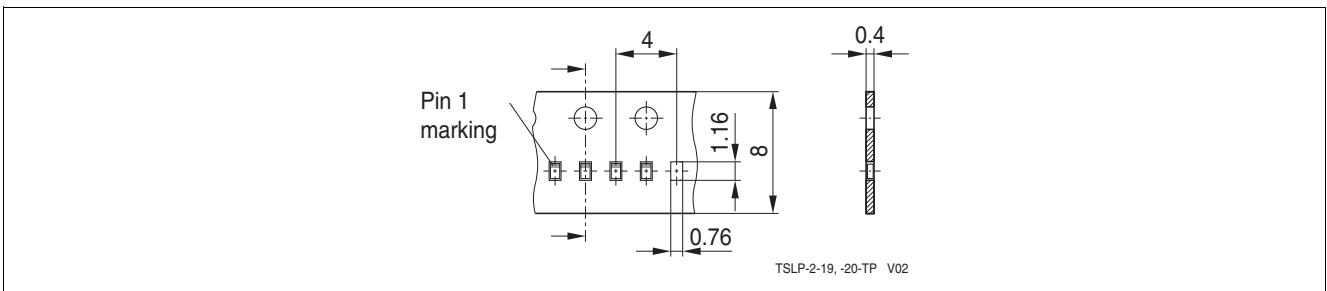

Figure 6-7 TSLP-2-20: Packing

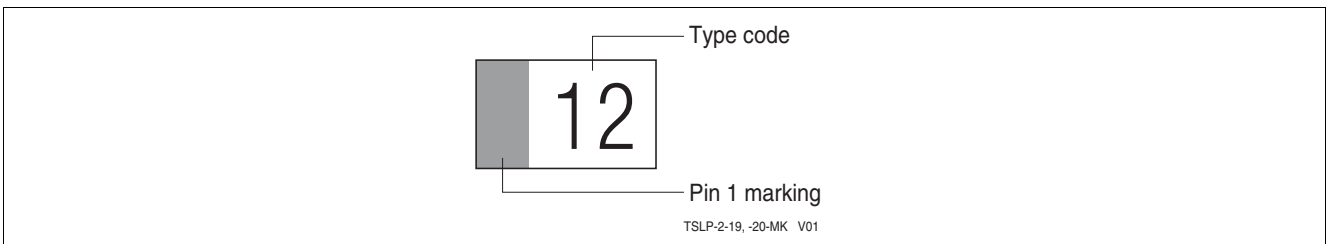

Figure 6-8 TSLP-2-20: Marking example [Table 1-1 "Part Information" on Page 3](#)

References

- [1] Infineon AG - **Application Note AN210**: Effective ESD Protection design at System Level Using VF-TLP Characterization Methodology
- [2] Infineon AG - Recommendations for PCB Assembly of Infineon TSLP and TSSLP Packages
- [3] Infineon AG - **Application Note AN244**: Tailored ESD Protection for the NFC Frontend

Revision History: Rev. 1.3, 2014-04-08

Page or Item	Subjects (major changes since previous revision)
Revision 1.4, 2014-10-23	
4	Table 2-1) updated

Trademarks of Infineon Technologies AG

AURIX™, BlueMoon™, COMNEON™, C166™, CROSSAVE™, CanPAK™, CIPOST™, CoolMOS™, CoolSET™, CORECONTROL™, DAVE™, EasyPIM™, EconoBRIDGE™, EconoDUAL™, EconoPACK™, EconoPIM™, EiceDRIVER™, EUPEC™, FCOS™, HITFET™, HybridPACK™, ISOFACE™, I²RF™, IsoPACK™, MIPAQ™, ModSTACK™, my-d™, NovalithIC™, OmniTune™, OptiMOS™, ORIGA™, PROFET™, PRO-SIL™, PRIMARION™, PrimePACK™, RASIC™, ReverSave™, SatRIC™, SIEGET™, SINDRION™, SMARTi™, SmartLEWIS™, TEMPFET™, thinQ!™, TriCore™, TRENCHSTOP™, X-GOLD™, XMM™, X-PMU™, XPOSYS™.

Other Trademarks

Advance Design System™ (ADS) of Agilent Technologies, AMBA™, ARM™, MULTI-ICE™, PRIMECELL™, REALVIEW™, THUMB™ of ARM Limited, UK. AUTOSAR™ is licensed by AUTOSAR development partnership. Bluetooth™ of Bluetooth SIG Inc. CAT-iq™ of DECT Forum. COLOSSUS™, FirstGPS™ of Trimble Navigation Ltd. EMV™ of EMVCo, LLC (Visa Holdings Inc.). EPCOS™ of Epcos AG. FLEXGO™ of Microsoft Corporation. FlexRay™ is licensed by FlexRay Consortium. HYPERTERMINAL™ of Hilgraeve Incorporated. IEC™ of Commission Electrotechnique Internationale. IrDA™ of Infrared Data Association Corporation. ISO™ of INTERNATIONAL ORGANIZATION FOR STANDARDIZATION. MATLAB™ of MathWorks, Inc. MAXIM™ of Maxim Integrated Products, Inc. MICROTEC™, NUCLEUS™ of Mentor Graphics Corporation. Mifare™ of NXP. MIPI™ of MIPI Alliance, Inc. MIPS™ of MIPS Technologies, Inc., USA. muRata™ of MURATA MANUFACTURING CO., MICROWAVE OFFICE™ (MWO) of Applied Wave Research Inc., OmniVision™ of OmniVision Technologies, Inc. Openwave™ Openwave Systems Inc. RED HAT™ Red Hat, Inc. RFMD™ RF Micro Devices, Inc. SIRIUS™ of Sirius Sattelite Radio Inc. SOLARIS™ of Sun Microsystems, Inc. SPANSION™ of Spansion LLC Ltd. Symbian™ of Symbian Software Limited. TAIYO YUDEN™ of Taiyo Yuden Co. TEAKLITE™ of CEVA, Inc. TEKTRONIX™ of Tektronix Inc. TOKO™ of TOKO KABUSHIKI KAISHA TA. UNIX™ of X/Open Company Limited. VERILOG™, PALLADIUM™ of Cadence Design Systems, Inc. VLYNQ™ of Texas Instruments Incorporated. VXWORKS™, WIND RIVER™ of WIND RIVER SYSTEMS, INC. ZETEX™ of Diodes Zetex Limited.

Last Trademarks Update 2010-06-09

www.infineon.com

Published by Infineon Technologies AG