

3-terminal filters
Signal line
MEM series



MEM2012V type



FEATURES

- Multilayer chip EMC filter.
- Monolithic structure makes it highly reliable.
- Closed magnetic circuit structure makes it possible to achieve high-density mounting without crosstalk.
- Has sharp attenuation characteristics with excellent EMC suppression.
- Wide range of products compatible with passing frequencies and attenuating frequencies.
- Double π type circuit is used.
- Sharp attenuation characteristics.
- Operating temperature range: -40 to $+85^{\circ}\text{C}$

APPLICATION

- Noise removal from signal lines of data terminals, digital cameras, computers, game machines, flat TVs, etc.
- Application guides: [Smart phones/tablets](#)

PART NUMBER CONSTRUCTION

MEM	2012	V	121R	T	001
Series name	LxWxT dimensions 2.0x1.25x0.85 mm	Product internal code	Cutoff frequency (MHz)	Packaging style	Internal code

CHARACTERISTICS SPECIFICATION TABLE

Cutoff frequency (MHz)	Insertion loss (dB)	Rated voltage (V)max.	Rated current (mA)max.	Part No.
120	20 [200MHz to 2GHz]	10	100	MEM2012V121RT001
150	20 [250MHz to 2GHz]	10	100	MEM2012V151RT001
180	20 [300MHz to 2GHz]	10	100	MEM2012V181RT001
210	20 [350MHz to 2GHz]	10	100	MEM2012V211RT001
240	20 [450MHz to 2GHz]	10	100	MEM2012V241RT001
300	20 [550MHz to 2GHz]	10	100	MEM2012V301RT001

Measurement equipment

Measurement item	Product No.	Manufacturer
Frequency characteristics	N5230C	Keysight Technologies

* Equivalent measurement equipment may be used.

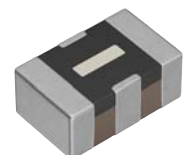

MEM2012V type

■ INSERTION LOSS VS. FREQUENCY CHARACTERISTICS

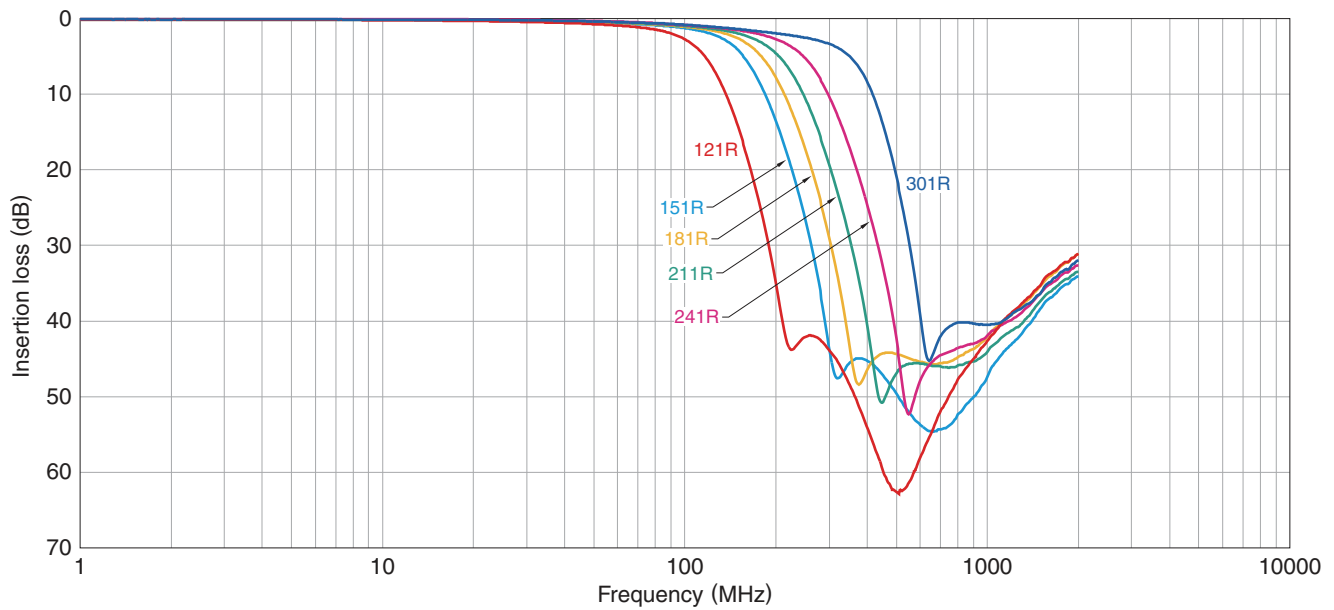

Measurement equipment

Product No.	Manufacturer
N5230C	Keysight Technologies

* Equivalent measurement equipment may be used.

MEM2012V type

SHAPE & DIMENSIONS

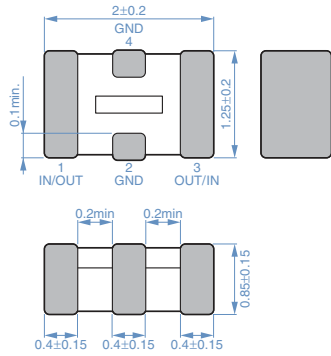

Dimensions in mm

RECOMMENDED LAND PATTERN

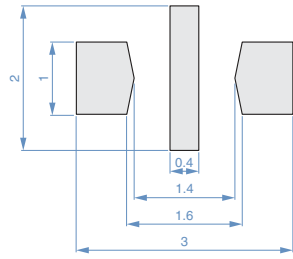

Dimensions in mm

CIRCUIT DIAGRAM

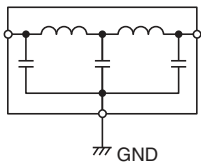

RECOMMENDED REFLOW PROFILE

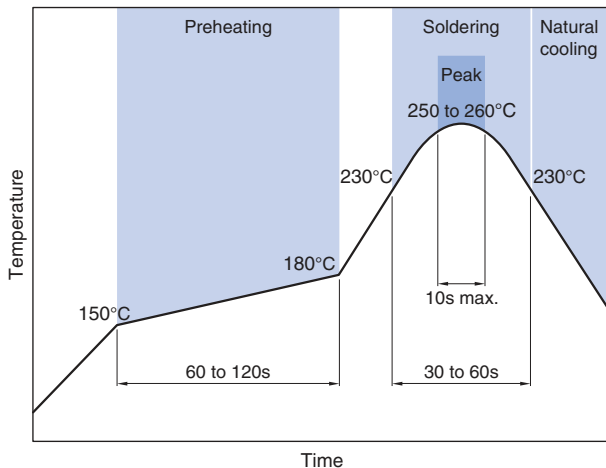

PACKAGING STYLE

REEL DIMENSIONS

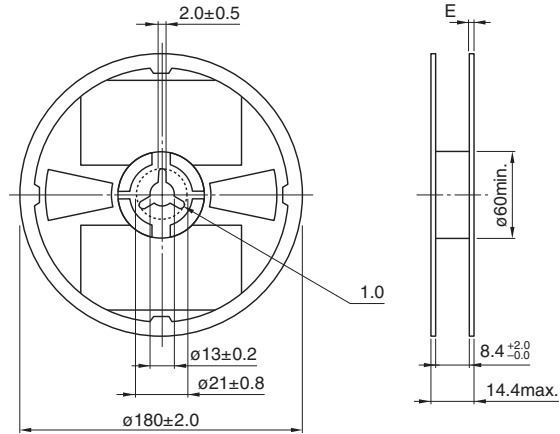

Dimensions in mm

TAPE DIMENSIONS

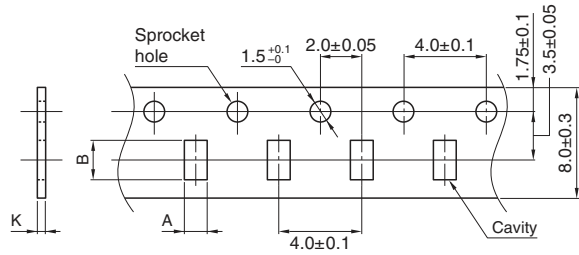

Dimensions in mm

Type	A	B	K
MEM2012V	1.55±0.20	2.30±0.20	1.10max.

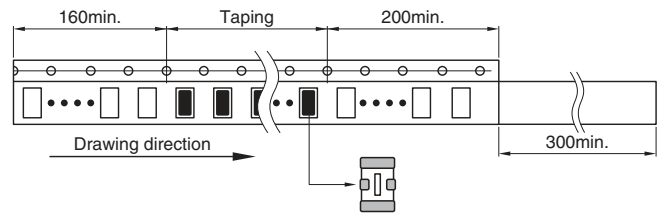

Dimensions in mm

PACKAGE QUANTITY

Package quantity	4,000 pcs/reel
------------------	----------------

TEMPERATURE RANGE, INDIVIDUAL WEIGHT

Operating temperature range	Storage temperature range*	Individual weight
-40 to +85 °C	-40 to +85 °C	8 mg

* The storage temperature range is for after the assembly.

REMINDERS FOR USING THESE PRODUCTS

Before using these products, be sure to request the delivery specifications.

SAFETY REMINDERS

Please pay sufficient attention to the warnings for safe designing when using this products.

REMINDERS

- The storage period is less than 12 months. Be sure to follow the storage conditions (temperature: 5 to 40°C, humidity: 10 to 75% RH or less).
If the storage period elapses, the soldering of the terminal electrodes may deteriorate.
- Do not use or store in locations where there are conditions such as gas corrosion (salt, acid, alkali, etc.).
- Before soldering, be sure to preheat components.
The preheating temperature should be set so that the temperature difference between the solder temperature and chip temperature does not exceed 150°C.
- Soldering corrections after mounting should be within the range of the conditions determined in the specifications.
If overheated, a short circuit, performance deterioration, or lifespan shortening may occur.
- When embedding a printed circuit board where a chip is mounted to a set, be sure that residual stress is not given to the chip due to the overall distortion of the printed circuit board and partial distortion such as at screw tightening portions.
- Self heating (temperature increase) occurs when the power is turned ON, so the tolerance should be sufficient for the set thermal design.
- Carefully lay out the coil for the circuit board design of the non-magnetic shield type.
A malfunction may occur due to magnetic interference.
- Use a wrist band to discharge static electricity in your body through the grounding wire.
- Do not expose the products to magnets or magnetic fields.
- Do not use for a purpose outside of the contents regulated in the delivery specifications.
- The products listed on this catalog are intended for use in general electronic equipment (AV equipment, telecommunications equipment, home appliances, amusement equipment, computer equipment, personal equipment, office equipment, measurement equipment, industrial robots) under a normal operation and use condition.
The products are not designed or warranted to meet the requirements of the applications listed below, whose performance and/or quality require a more stringent level of safety or reliability, or whose failure, malfunction or trouble could cause serious damage to society, person or property.
If you intend to use the products in the applications listed below or if you have special requirements exceeding the range or conditions set forth in the each catalog, please contact us.

- (1) Aerospace/aviation equipment
- (2) Transportation equipment (cars, electric trains, ships, etc.)
- (3) Medical equipment
- (4) Power-generation control equipment
- (5) Atomic energy-related equipment
- (6) Seabed equipment
- (7) Transportation control equipment

- (8) Public information-processing equipment
- (9) Military equipment
- (10) Electric heating apparatus, burning equipment
- (11) Disaster prevention/crime prevention equipment
- (12) Safety equipment
- (13) Other applications that are not considered general-purpose applications

When designing your equipment even for general-purpose applications, you are kindly requested to take into consideration securing protection circuit/device or providing backup circuits in your equipment.