

Single Phase Fast Recovery Bridge (Power Modules), 61 A



SOT-227

RoHS
COMPLIANT

FEATURES

- Fast recovery time characteristic
- Electrically isolated base plate
- Simplified mechanical designs, rapid assembly
- Excellent power/volume ratio
- Designed and qualified for industrial and consumer level
- UL approved file E78996 
- Material categorization: for definitions of compliance please see www.vishay.com/doc?99912

DESCRIPTION

The semiconductor in the SOT-227 package is isolated from the copper base plate, allowing for common heatsinks and compact assemblies to be built.

PRIMARY CHARACTERISTICS	
V_{RRM}	600 V
I_o	61 A
t_{rr}	170 ns
Type	Modules - Bridge, Fast
Package	SOT-227
Circuit configuration	Single phase bridge

MAJOR RATINGS AND CHARACTERISTICS			
SYMBOL	CHARACTERISTICS	VALUES	UNITS
I_o		61	A
	T_C	57	°C
I_{FSM}	50 Hz	300	A
	60 Hz	310	
I^2t	50 Hz	442	A ² s
	60 Hz	402	
V_{RRM}		600	V
T_J		-55 to +150	°C

ELECTRICAL SPECIFICATIONS

VOLTAGE RATINGS				
TYPE NUMBER	VOLTAGE CODE	V_{RRM} , MAXIMUM REPETITIVE PEAK REVERSE VOLTAGE V	V_{RSM} , MAXIMUM NON-REPETITIVE PEAK REVERSE VOLTAGE V	I_{RRM} MAXIMUM AT T_J MAXIMUM mA
SA61BA60	60	600	700	10



FORWARD CONDUCTION					
PARAMETER	SYMBOL	TEST CONDITIONS		VALUES	UNITS
Maximum DC output current at case temperature	I _O	Resistive or inductive load		61	A
				57	°C
Maximum peak, one-cycle non-repetitive forward current	I _{FSM}	t = 10 ms	No voltage reapplied	300	A
		t = 8.3 ms		310	
		t = 10 ms	100 % V _{RRM} reapplied	250	
		t = 8.3 ms		260	
Maximum I ² t for fusing	I ² t	t = 10 ms	No voltage reapplied	442	A ² s
		t = 8.3 ms		402	
		t = 10 ms	100 % V _{RRM} reapplied	313	
		t = 8.3 ms		284	
Maximum I ² √t for fusing	I ² √t	I ² t for time t _x = I ₂ √t × √t _x ; 0.1 ≤ t _x ≤ 10 ms, V _{RRM} = 0 V		4.4	kA ² √s
Value of threshold voltage	V _{F(TO)}	T _J maximum		0.914	V
Forward slope resistance	r _t			10.5	mΩ
Maximum forward voltage drop	V _{FM}	T _J = 25 °C, I _{FM} = 30 A _{pk}	t _p = 400 μs	1.33	V
		T _J = T _J maximum, I _{FM} = 30 A _{pk}		1.23	
RMS isolation voltage base plate	V _{ISOL}	f = 50 Hz, t = 1 s		3000	

RECOVERY CHARACTERISTICS				
PARAMETER	SYMBOL	TEST CONDITIONS	VALUES	UNITS
Reverse recovery time, typical	t _{rr}	T _J = 25 °C, I _F = 20 A, V _R = 30 V, di _F /dt = 100 A/μs	170	ns
		T _J = 125 °C, I _F = 20 A, V _R = 30 V, di _F /dt = 100 A/μs	250	
Reverse recovery current, typical	I _{rr}	T _J = 25 °C, I _F = 20 A, V _R = 30 V, di _F /dt = 100 A/μs	10.5	A
		T _J = 125 °C, I _F = 20 A, V _R = 30 V, di _F /dt = 100 A/μs	16	
Reverse recovery charge, typical	Q _{rr}	T _J = 25 °C, I _F = 20 A, V _R = 30 V, di _F /dt = 100 A/μs	900	nC
		T _J = 125 °C, I _F = 20 A, V _R = 30 V, di _F /dt = 100 A/μs	1970	
Snap factor, typical	S	T _J = 25 °C	0.6	-
Junction capacitance, typical	C _T	V _R = 600 V	67	pF

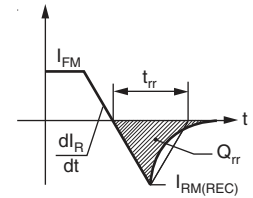

THERMAL AND MECHANICAL SPECIFICATIONS						
PARAMETER	SYMBOL	TEST CONDITIONS	MIN.	TYP.	MAX.	UNITS
Junction and storage temperature range	T _J , T _{Stg}		- 55	-	150	°C
Thermal resistance junction to case, per diode	R _{thJC}		-	-	1.2	°C/W
Thermal resistance junction to case, per module			-	-	0.30	
Thermal resistance case to heatsink	R _{thCS}	Flat, greased surface	-	0.05	-	
Weight			-	30	-	g
Mounting torque		Torque to terminal	-	-	1.1 (9.7)	Nm (lbf.in)
		Torque to heatsink	-	-	1.8 (15.9)	Nm (lbf.in)
Case style						SOT-227

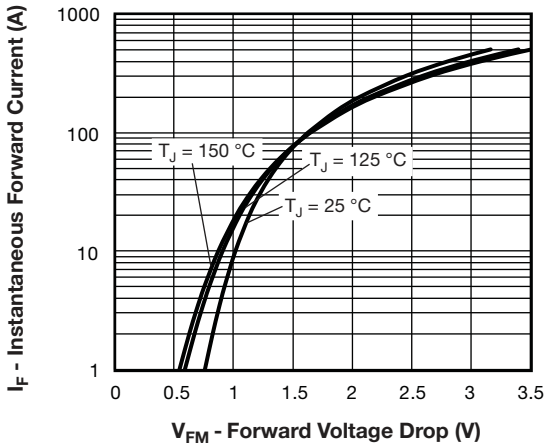

Fig. 1 - Typical Forward Voltage Drop Characteristics

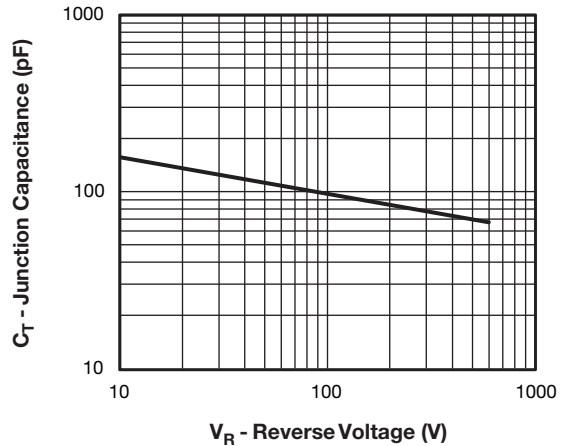

Fig. 3 - Typical Junction Capacitance vs. Reverse Voltage

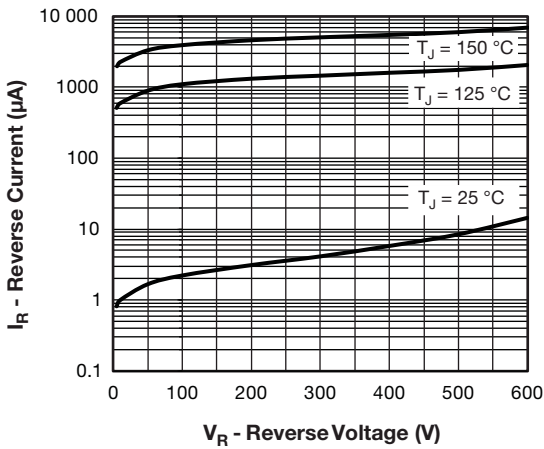

Fig. 2 - Typical Values of Reverse Current vs. Reverse Voltage

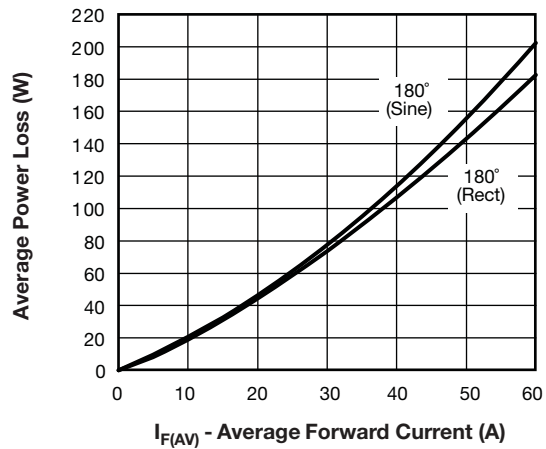

Fig. 4 - Current Rating Characteristics

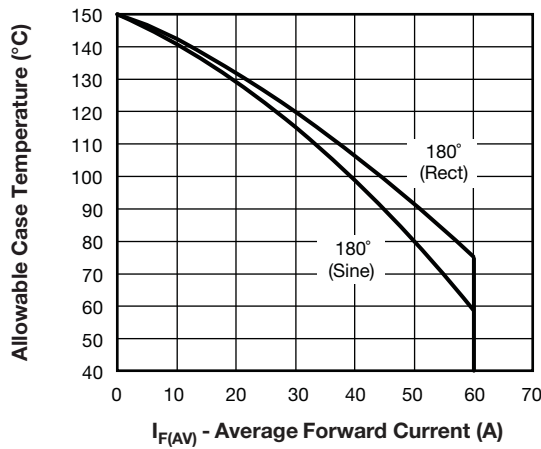

Fig. 5 - Forward Power Loss Characteristics

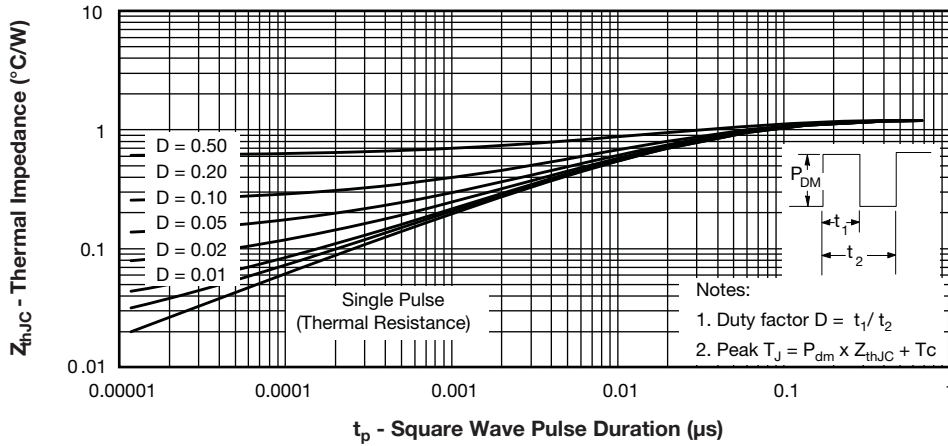

Fig. 6 - Typical Forward Voltage Drop Characteristics

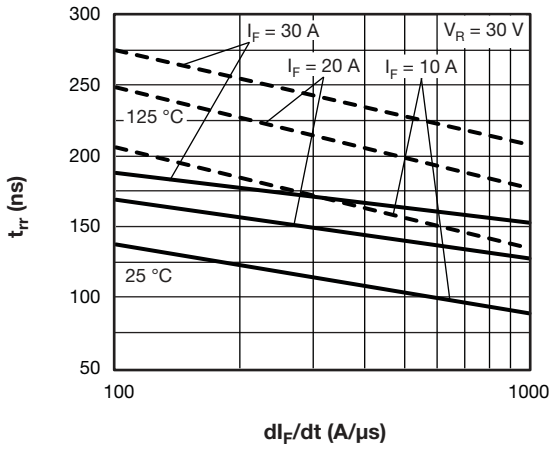

Fig. 7 - Typical Reverse Recovery Time vs. di_F/dt

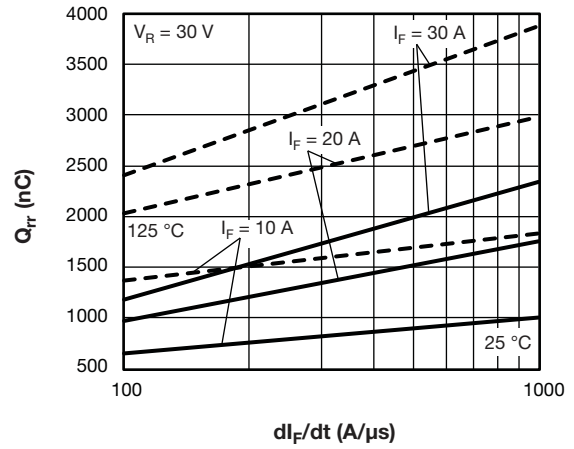

Fig. 8 - Typical Stored Charge vs. di_F/dt

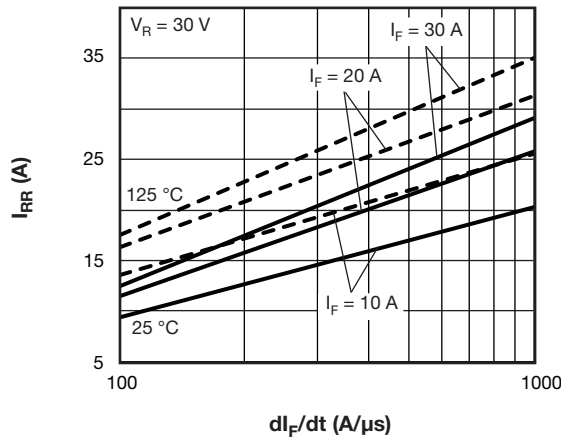

Fig. 9 - Typical Reverse Recovery Current vs. di_F/dt

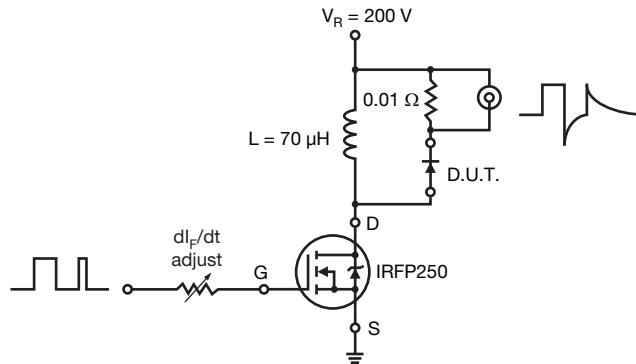
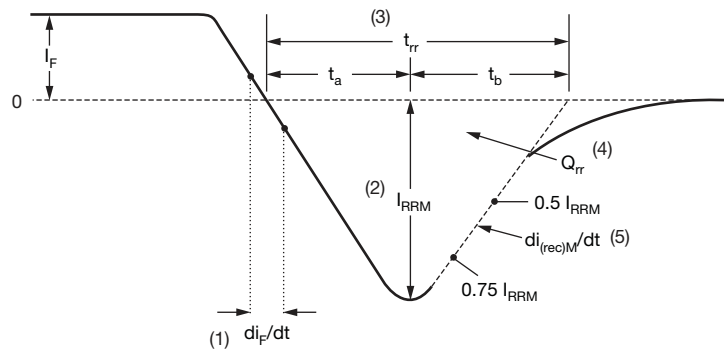

Fig. 10 - Reverse Recovery Parameter Test Circuit



- (1) di_F/dt - rate of change of current through zero crossing
- (2) I_{RRM} - peak reverse recovery current
- (3) t_{rr} - reverse recovery time measured from zero crossing point of negative going I_F to point where a line passing through $0.75 I_{RRM}$ and $0.50 I_{RRM}$ extrapolated to zero current.
- (4) Q_{rr} - area under curve defined by t_{rr} and I_{RRM}
- (5) $di_{(rec)M}/dt$ - peak rate of change of current during t_b portion of t_{rr}

$$Q_{rr} = \frac{t_{rr} \times I_{RRM}}{2}$$

Fig. 11 - Reverse Recovery Waveform and Definitions

ORDERING INFORMATION TABLE

Device code	VS-	S	A	61	B	A	60
	①	②	③	④	⑤	⑥	⑦

- 1** - Vishay Semiconductors product
- 2** - S = fast recovery diode
- 3** - A = present silicon generation
- 4** - Current rating (61 = 61 A)
- 5** - Circuit configuration:
B = single phase bridge
- 6** - Package indicator:
A = SOT-227, standard insulated base
- 7** - Voltage rating (60 = 600 V)



CIRCUIT CONFIGURATION		
CIRCUIT	CIRCUIT CONFIGURATION CODE	CIRCUIT DRAWING
Single phase bridge	B	

LINKS TO RELATED DOCUMENTS	
Dimensions	www.vishay.com/doc?95423
Packaging information	www.vishay.com/doc?95425



SOT-227 Generation 2

DIMENSIONS in millimeters (inches)

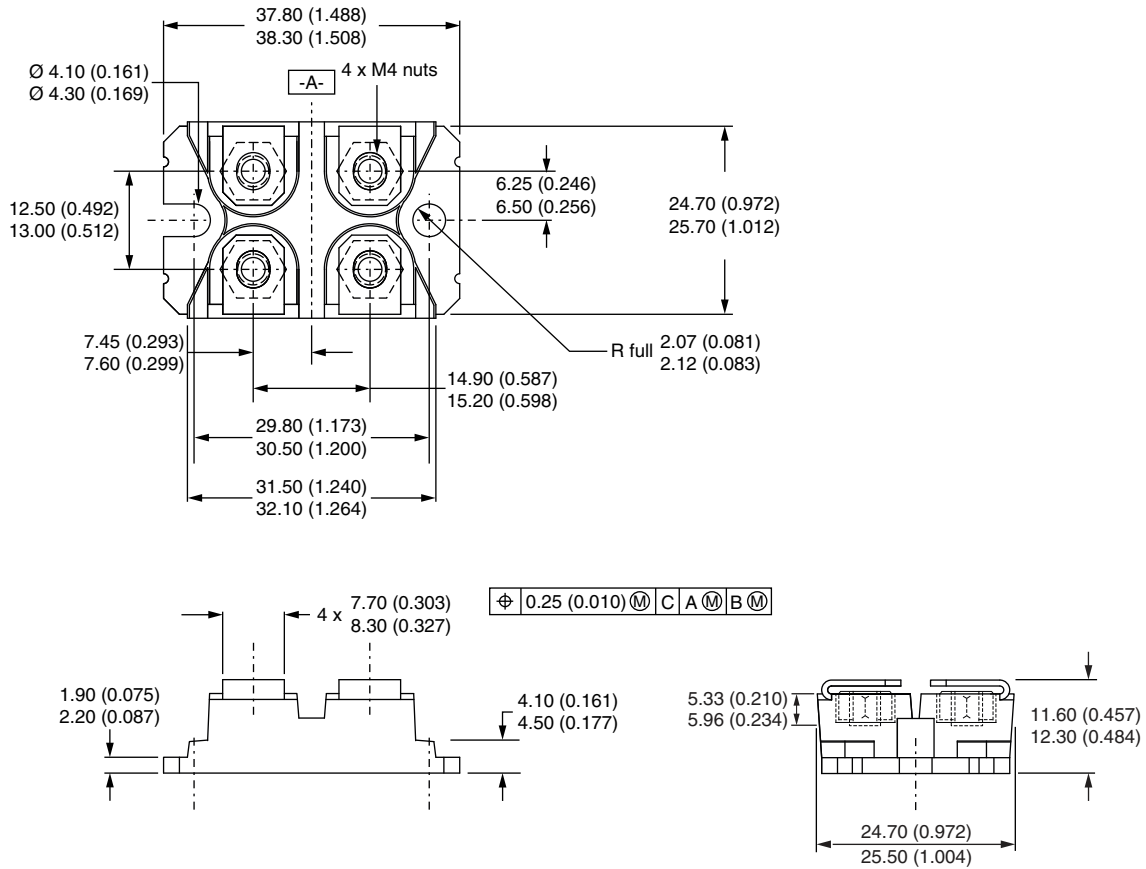

Note

- Controlling dimension: millimeter



Disclaimer

ALL PRODUCT, PRODUCT SPECIFICATIONS AND DATA ARE SUBJECT TO CHANGE WITHOUT NOTICE TO IMPROVE RELIABILITY, FUNCTION OR DESIGN OR OTHERWISE.

Vishay Intertechnology, Inc., its affiliates, agents, and employees, and all persons acting on its or their behalf (collectively, "Vishay"), disclaim any and all liability for any errors, inaccuracies or incompleteness contained in any datasheet or in any other disclosure relating to any product.

Vishay makes no warranty, representation or guarantee regarding the suitability of the products for any particular purpose or the continuing production of any product. To the maximum extent permitted by applicable law, Vishay disclaims (i) any and all liability arising out of the application or use of any product, (ii) any and all liability, including without limitation special, consequential or incidental damages, and (iii) any and all implied warranties, including warranties of fitness for particular purpose, non-infringement and merchantability.

Statements regarding the suitability of products for certain types of applications are based on Vishay's knowledge of typical requirements that are often placed on Vishay products in generic applications. Such statements are not binding statements about the suitability of products for a particular application. It is the customer's responsibility to validate that a particular product with the properties described in the product specification is suitable for use in a particular application. Parameters provided in datasheets and / or specifications may vary in different applications and performance may vary over time. All operating parameters, including typical parameters, must be validated for each customer application by the customer's technical experts. Product specifications do not expand or otherwise modify Vishay's terms and conditions of purchase, including but not limited to the warranty expressed therein.

Hyperlinks included in this datasheet may direct users to third-party websites. These links are provided as a convenience and for informational purposes only. Inclusion of these hyperlinks does not constitute an endorsement or an approval by Vishay of any of the products, services or opinions of the corporation, organization or individual associated with the third-party website. Vishay disclaims any and all liability and bears no responsibility for the accuracy, legality or content of the third-party website or for that of subsequent links.

Except as expressly indicated in writing, Vishay products are not designed for use in medical, life-saving, or life-sustaining applications or for any other application in which the failure of the Vishay product could result in personal injury or death. Customers using or selling Vishay products not expressly indicated for use in such applications do so at their own risk. Please contact authorized Vishay personnel to obtain written terms and conditions regarding products designed for such applications.

No license, express or implied, by estoppel or otherwise, to any intellectual property rights is granted by this document or by any conduct of Vishay. Product names and markings noted herein may be trademarks of their respective owners.