

GaN Amplifier 50 V, 2 W 1 - 5 GHz



MAGX-101050-002C0P

Rev. V2

Features

- Suitable for Linear and Saturated Applications
- CW & Pulsed Operation: 2 W Output Power
- Internally Pre-Matched
- 50 V Operation
- 100% RF Tested
- RoHS* Compliant

Applications

- Military Radio Communications
- RADAR
- Avionics
- Digital Cellular Infrastructure
- RF Energy
- Test Instrumentation

Description

The MAGX-101050-002C0P is a GaN on Si HEMT D-mode amplifier designed for 2 W peak power and optimized for 1 - 5 GHz frequency operation. This device supports both CW and pulsed operation with minimum output power levels of 2 W (33 dBm) in a 4 mm plastic package.

The MAGX-101050-002C0P has a wide range of applications.

Typical Performance:

- $V_{DS} = 50\text{ V}$, $I_{DQ} = 20\text{ mA}$, $T_C = 25^\circ\text{C}$.
Measured under load-pull at 2.5 dB Compression, 100 μs pulse width, 10% duty cycle.

Frequency (GHz)	Output Power ¹ (dBm)	Gain ² (dB)	η_D^2 (%)
1.0	38.1	11.2	78.6
2.0	37.9	13.9	69.0
3.0	36.7	15.2	55.1
4.0	37.5	15.4	55.3
5.0	37.4	11.2	53.8

1. Load impedance tuned for maximum output power.
2. Load impedance tuned for maximum drain efficiency.



4 mm DFN

Functional Schematic

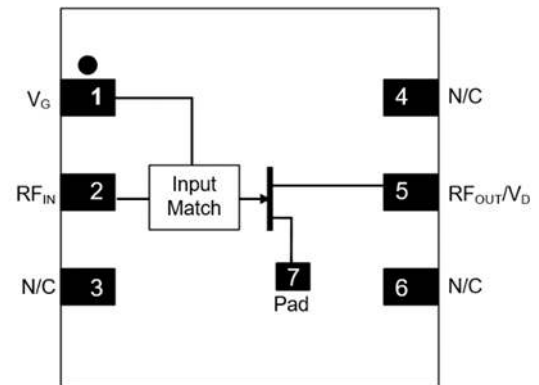

Pin Configuration

Pin #	Pin Name	Function
1	V_G	Gate
2	RF_{IN}	RF Input
3, 4, 6	N/C	No Connection
5	RF_{OUT} / V_D	RF Output / Drain
7	Pad ³	Ground / Source

3. The pad on the package bottom must be connected to RF, DC and thermal ground.

Ordering Information

Part Number	Package
MAGX-101050-002C0P	Bulk Quantity
MAGX-101050-002CTP	Tape and Reel
MAGX-1A1050-002C0P	Sample Board

GaN Amplifier 50 V, 2 W 1 - 5 GHz



MAGX-101050-002C0P

Rev. V2

RF Electrical Characteristics: $T_C = 25^\circ\text{C}$, $V_{DS} = 50\text{ V}$, $I_{DQ} = 20\text{ mA}$
Note: Performance in MACOM Evaluation Test Fixture, 50 Ω system

Parameter	Test Conditions	Symbol	Min.	Typ.	Max.	Units
Small Signal Gain	Pulsed ⁴ , 4 GHz	G_{SS}	-	18.3	-	dB
Power Gain	Pulsed ⁴ , 4 GHz, 2.5 dB Gain Compression	G_{SAT}	-	15.7	-	dB
Saturated Drain Efficiency	Pulsed ⁴ , 4 GHz, 2.5 dB Gain Compression	η_{SAT}	-	50.2	-	%
Saturated Output Power	Pulsed ⁴ , 4 GHz, 2.5 dB Gain Compression	P_{SAT}	-	35.7	-	dBm
Gain Variation (-40°C to +85°C)	Pulsed ⁴ , 4 GHz	ΔG	-	0.022	-	dB/°C
Power Variation (-40°C to +85°C)	Pulsed ⁴ , 4 GHz	$\Delta P_{2.5dB}$	-	0.003	-	dB/°C
Power Gain	Pulsed ⁴ , 4 GHz, $P_{IN} = 15.2\text{ dBm}$	G_P	-	17.7	-	dB
Drain Efficiency	Pulsed ⁴ , 4 GHz, $P_{IN} = 15.2\text{ dBm}$	η	-	39	-	%
Input Return Loss	Pulsed ⁴ , 4 GHz, $P_{IM} = 15.2\text{ dBm}$	IRL	-	-17	-	dB
Ruggedness: Output Mismatch	All phase angles	Ψ	VSWR = 10:1, No Damage			

RF Electrical Specifications: $T_A = 25^\circ\text{C}$, $V_{DS} = 50\text{ V}$, $I_{DQ} = 20\text{ mA}$
Note: Performance in MACOM Production Test Fixture, 50 Ω system

Parameter	Test Conditions	Symbol	Min.	Typ.	Max.	Units
Power Gain	Pulsed ⁴ , 4 GHz, 2.5 dB Gain Compression	G_{SAT}	11.8	13.1	-	dB
Saturated Drain Efficiency	Pulsed ⁴ , 4 GHz, 2.5 dB Gain Compression	η_{SAT}	37.2	41.5	-	%
Saturated Output Power	Pulsed ⁴ , 4 GHz, 2.5 dB Gain Compression	P_{SAT}	35.1	35.8	-	dBm

4. Pulse details: 100 μs pulse width, 10% Duty Cycle.

DC Electrical Characteristics: $T_A = 25^\circ\text{C}$

Parameter	Test Conditions	Symbol	Min.	Typ.	Max.	Units
Drain-Source Leakage Current	$V_{GS} = -8\text{ V}$, $V_{DS} = 130\text{ V}$	I_{DLK}	-	-	0.72	mA
Gate-Source Leakage Current	$V_{GS} = -8\text{ V}$, $V_{DS} = 0\text{ V}$	I_{GLK}	-	-	0.72	mA
Gate Threshold Voltage	$V_{DS} = 50\text{ V}$, $I_D = 0.72\text{ mA}$	V_T	-2.6	-2.0	-	V
Gate Quiescent Voltage	$V_{DS} = 50\text{ V}$, $I_D = 20\text{ mA}$	V_{GSQ}	-2.0	-1.7	-1.4	V
Maximum Drain Current	$V_{DS} = 7\text{ V}$, pulse width 300 μs	$I_{D, MAX}$	-	0.61	-	A

Absolute Maximum Ratings^{5,6,7,8,9}

Parameter	Absolute Maximum
Drain Source Voltage, V_{DS}	130 V
Gate Source Voltage, V_{GS}	-10 to 3 V
Gate Current, I_G	1.4 mA
Storage Temperature Range	-65°C to +150°C
Case Operating Temperature Range	-40°C to +85°C
Channel Operating Temperature Range, T_{CH}	-40°C to +225°C
Absolute Maximum Channel Temperature	+250°C

5. Exceeding any one or combination of these limits may cause permanent damage to this device.
6. MACOM does not recommend sustained operation above maximum operating conditions.
7. Operating at drain source voltage $V_{DS} < 55$ V will ensure $MTTF > 4 \times 10^6$ hours.
8. Operating at nominal conditions with $T_{CH} \leq 225^\circ\text{C}$ will ensure $MTTF > 4 \times 10^6$ hours.
9. $MTTF$ may be estimated by the expression $MTTF \text{ (hours)} = A e^{[B + C/(T+273)]}$ where T is the channel temperature in degrees Celsius, $A = 1.76$, $B = -33.83$, and $C = 23,476$.

Thermal Characteristics¹⁰

Parameter	Test Conditions	Symbol	Typical	Units
Thermal Resistance using Finite Element Analysis	$V_{DS} = 50$ V $T_C = 85^\circ\text{C}, T_{CH} = 225^\circ\text{C}$	$R_{\theta}(\text{FEA})$	35.4	°C/W
Thermal Resistance using Infrared Measurement of Die Surface Temperature	$V_{DS} = 50$ V $T_C = 85^\circ\text{C}, T_{CH} = 225^\circ\text{C}$	$R_{\theta}(\text{IR})$	31.9	°C/W

10. Case temperature measured using thermocouple embedded in heat-sink. Contact local applications support team for more details on this measurement.

Handling Procedures

Please observe the following precautions to avoid damage:

Static Sensitivity

Gallium Nitride Circuits are sensitive to electrostatic discharge (ESD) and can be damaged by static electricity. Proper ESD control techniques should be used when handling.

**Pulsed⁴ Load-Pull Performance
Reference Plane at Device Leads**

Frequency (GHz)	Z_{SOURCE} (Ω)	Maximum Output Power					
		$V_{DS} = 50\text{ V}, I_{DQ} = 20\text{ mA}, T_C = 25^\circ\text{C}, P_{2.5\text{ dB}}$					
		Z_{LOAD}^{11} (Ω)	Gain (dB)	P_{OUT} (dBm)	P_{OUT} (W)	η_D (%)	AM/PM ($^\circ$)
1	40.3 - j9.3	111.3 + j77.2	9.8	38.1	6.5	69.7	148.9
2	10.7 + j20.6	48.6 + j74.0	13.2	37.9	6.2	63.2	80.7
3	7.4 - j10.3	28.7 + j65.4	14.7	36.7	4.7	53.9	38.1
4	46.6 - j34.0	26.4 + j46.9	14.9	37.5	5.6	52.5	-28.5
5	19.5 + j2.4	19.0 + j37.8	10.8	37.4	5.6	50.5	-129.1

Frequency (GHz)	Z_{SOURCE} (Ω)	Maximum Drain Efficiency					
		$V_{DS} = 50\text{ V}, I_{DQ} = 20\text{ mA}, T_C = 25^\circ\text{C}, P_{2.5\text{ dB}}$					
		Z_{LOAD}^{12} (Ω)	Gain (dB)	P_{OUT} (dBm)	P_{OUT} (W)	η_D (%)	AM/PM ($^\circ$)
1	39.8 - j8.6	118.1 + j148.6	11.2	36.7	4.7	78.6	145.4
2	11.3 + j20.1	52.3 + j96.7	13.9	37.1	5.1	69.0	72.9
3	8.1 - j10.9	26.3 + j74.5	15.2	36.1	4.1	55.1	30.7
4	49.6 - j24.9	19.7 + j53.8	15.4	36.8	4.8	55.3	-35.9
5	18.9 + j1.8	13.3 + j41.3	11.2	36.8	4.8	53.8	-133.1

Impedance Reference

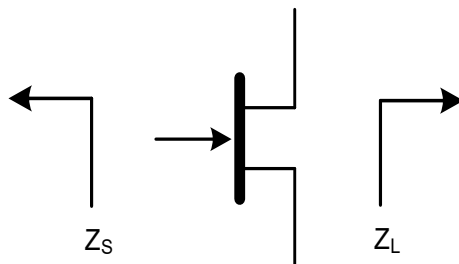

Z_{SOURCE} = Measured impedance presented to the input of the device at package reference plane.

Z_{LOAD} = Measured impedance presented to the output of the device at package reference plane.

- 11. Load Impedance for optimum output power.
- 12. Load Impedance for optimum efficiency.

Pulsed⁴ Load-Pull Performance 50 V, 1 GHz

P2.5dB Loadpull Output Power Contours (dBm)

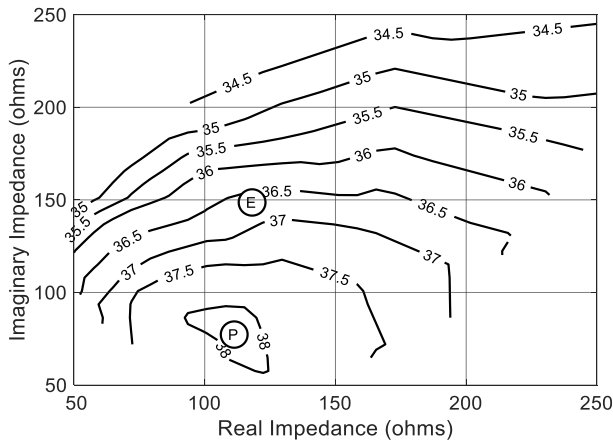

P2.5dB Loadpull Drain Efficiency Contours (%)

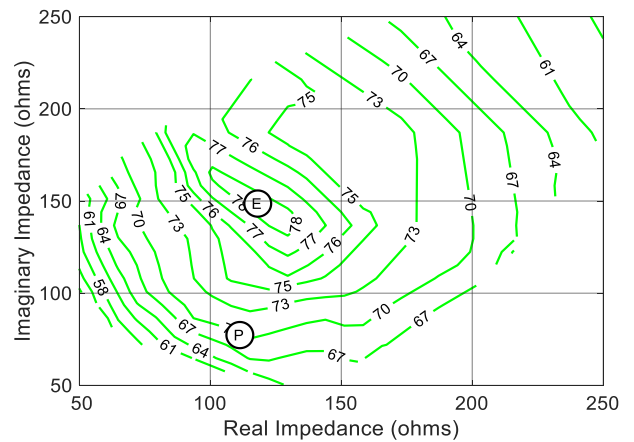

P2.5dB Loadpull Gain Contours (dB)

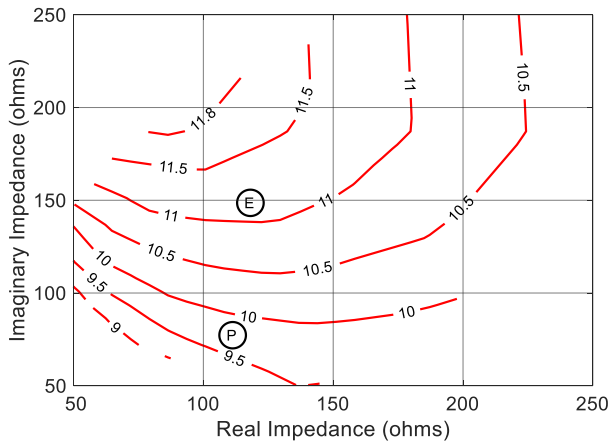

P2.5dB Loadpull AM/PM Contours (°)

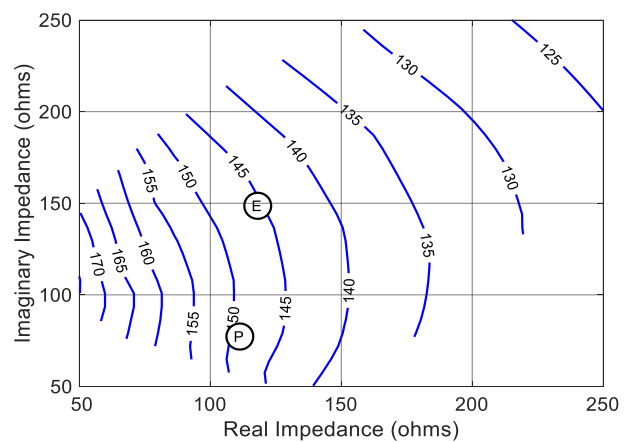

Gain vs. Output Power

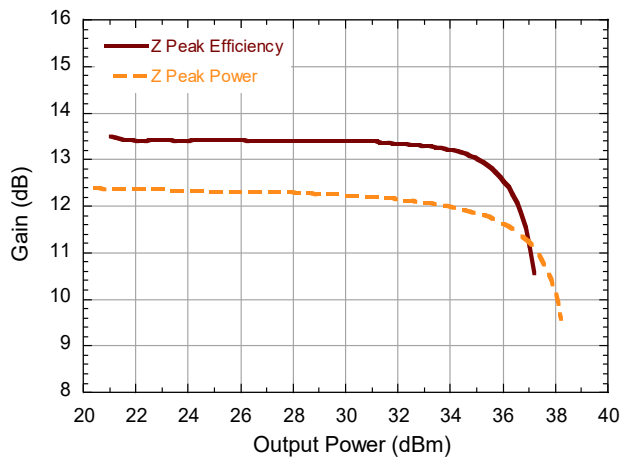

Drain Efficiency vs. Output Power

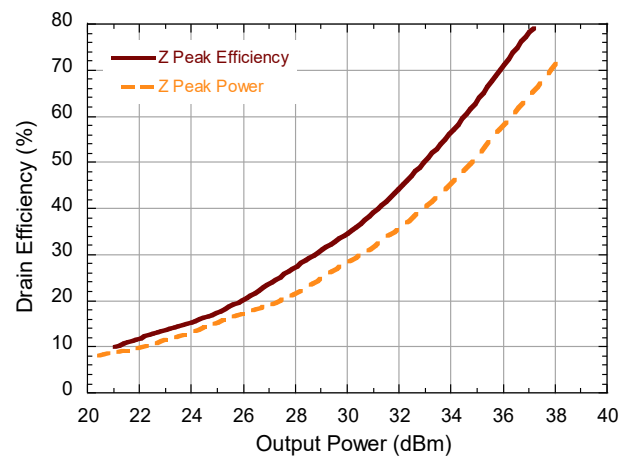

Pulsed⁴ Load-Pull Performance 50 V, 2 GHz

P2.5dB Loadpull Output Power Contours (dBm)

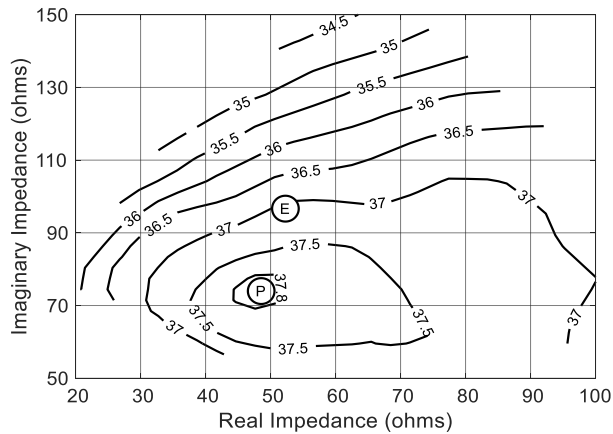

P2.5dB Loadpull Drain Efficiency Contours (%)

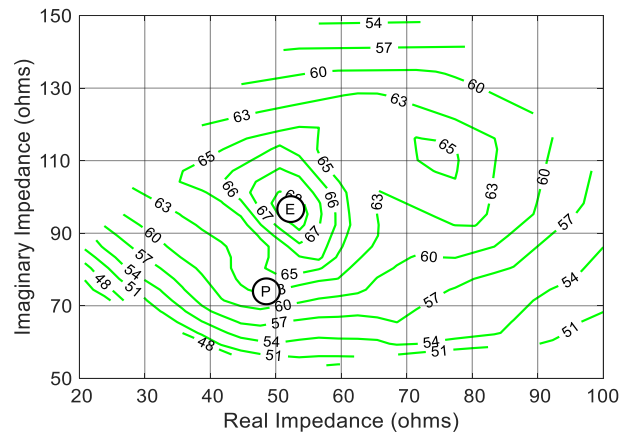

P2.5dB Loadpull Gain Contours (dB)

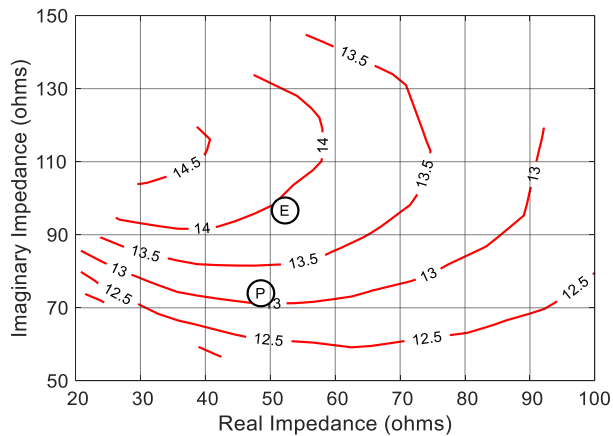

P2.5dB Loadpull AM/PM Contours (°)

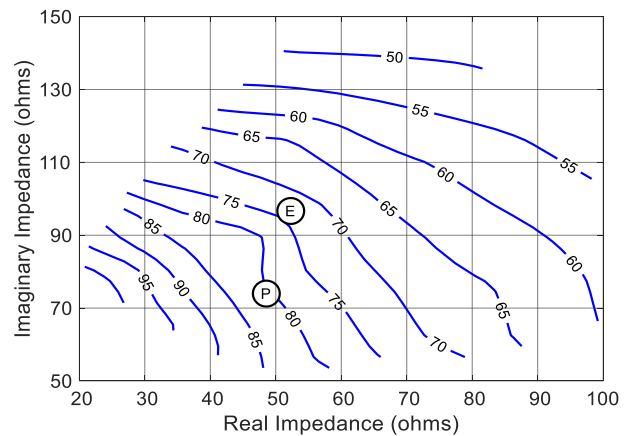

Gain vs. Output Power

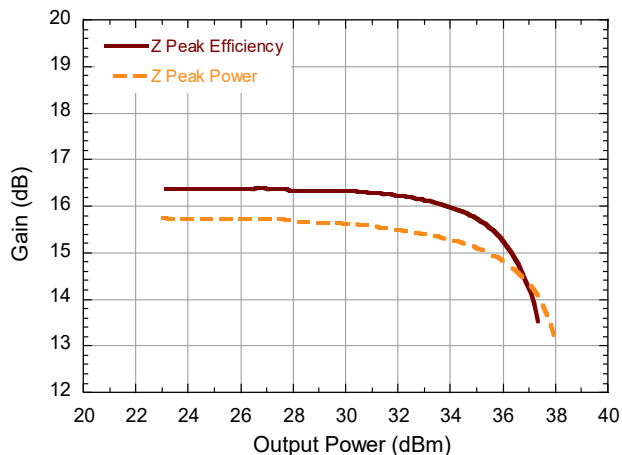

Drain Efficiency vs. Output Power

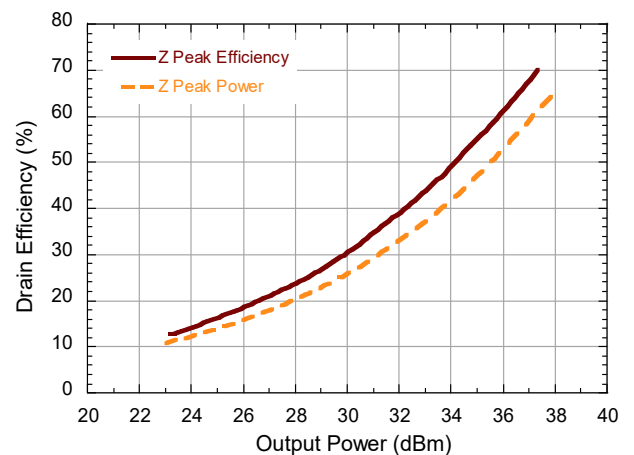

Pulsed⁴ Load-Pull Performance 50 V, 3 GHz

P2.5dB Loadpull Output Power Contours (dBm)

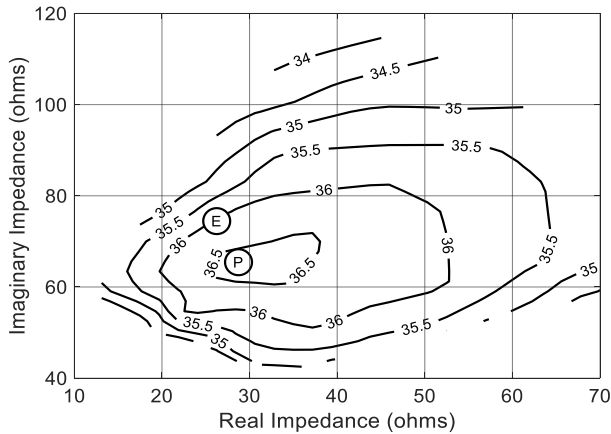

P2.5dB Loadpull Drain Efficiency Contours (%)

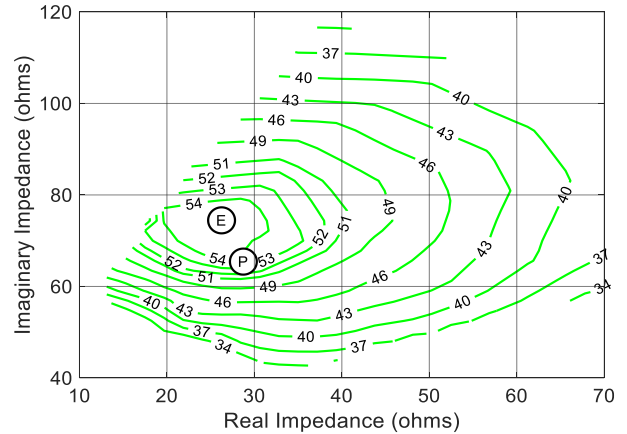

P2.5dB Loadpull Gain Contours (dB)

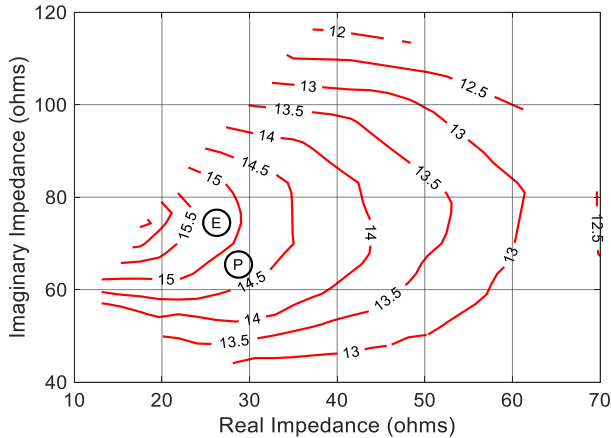

P2.5dB Loadpull AM/PM Contours (°)

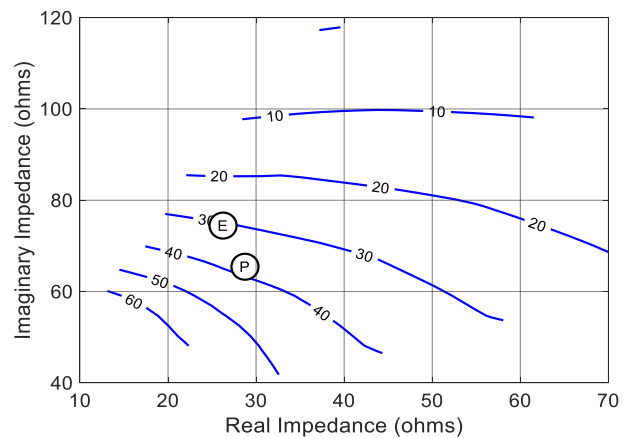

Gain vs. Output Power

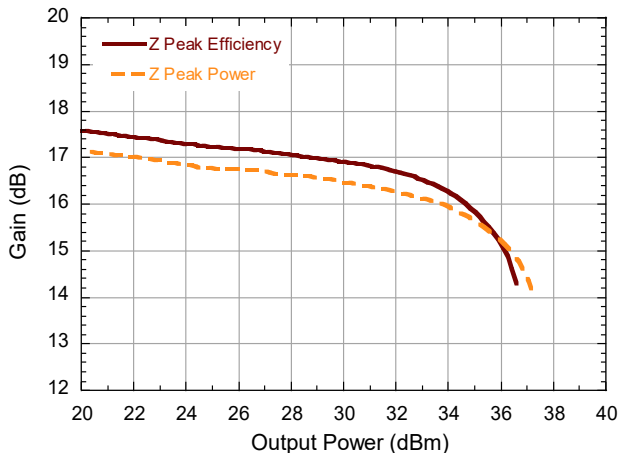

Drain Efficiency vs. Output Power

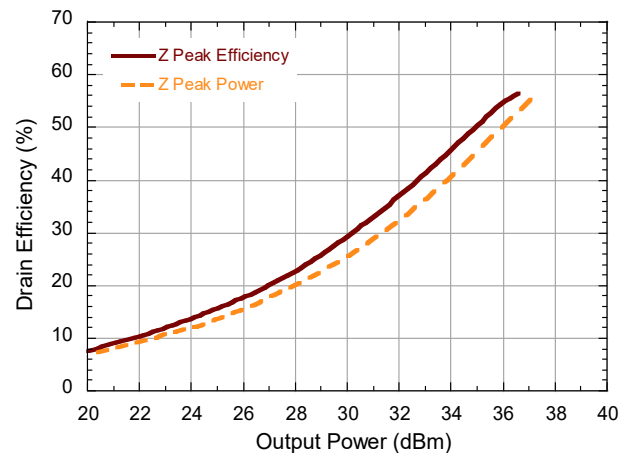

Pulsed⁴ Load-Pull Performance 50 V, 4 GHz

P2.5dB Loadpull Output Power Contours (dBm)

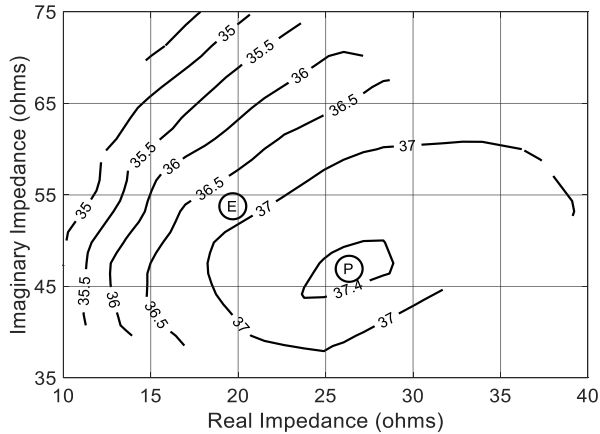

P2.5dB Loadpull Drain Efficiency Contours (%)

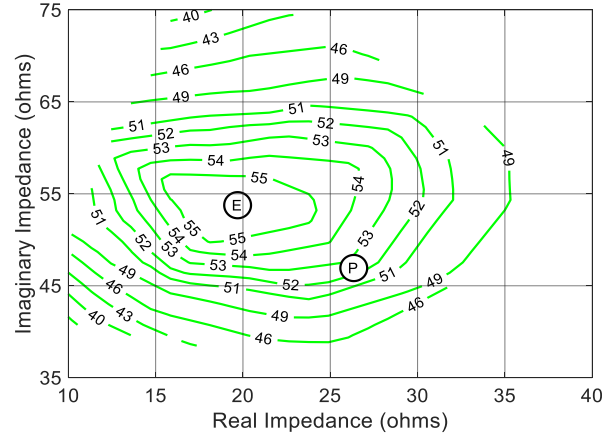

P2.5dB Loadpull Gain Contours (dB)

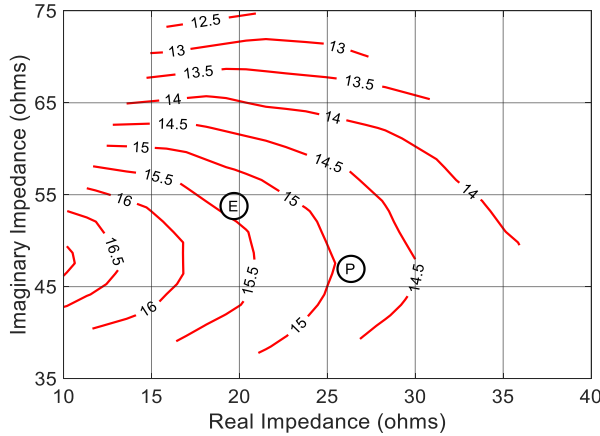

P2.5dB Loadpull AM/PM Contours (°)

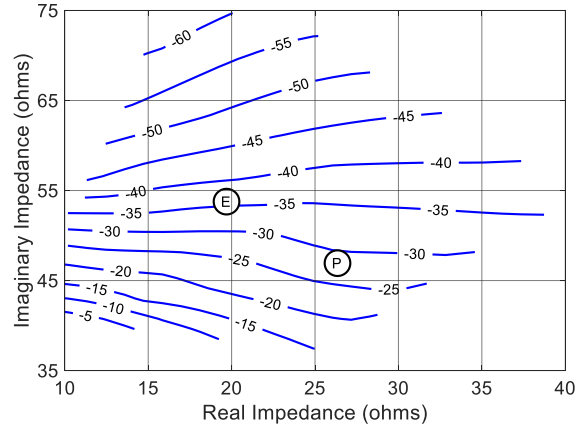

Gain vs. Output Power

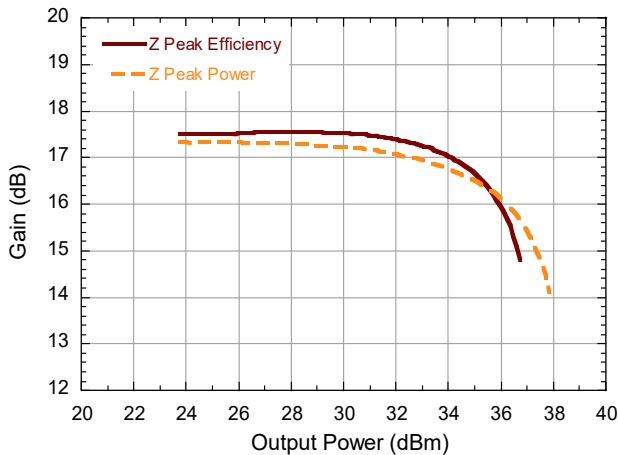

Drain Efficiency vs. Output Power

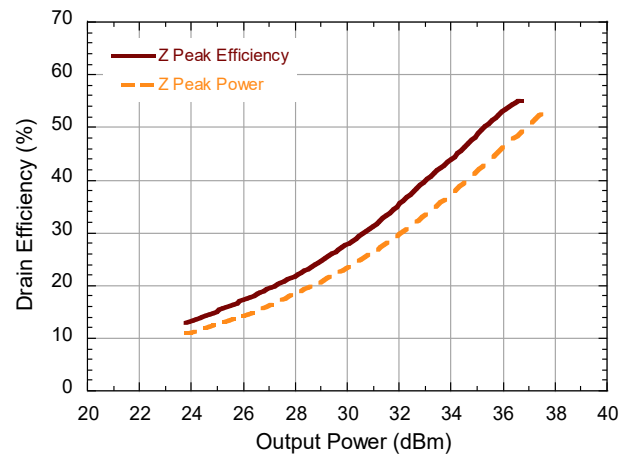

Pulsed⁴ Load-Pull Performance 50 V, 5 GHz

P2.5dB Loadpull Output Power Contours (dBm)

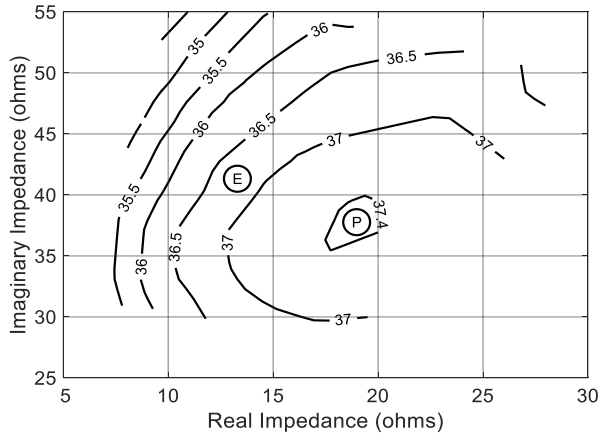

P2.5dB Loadpull Drain Efficiency Contours (%)

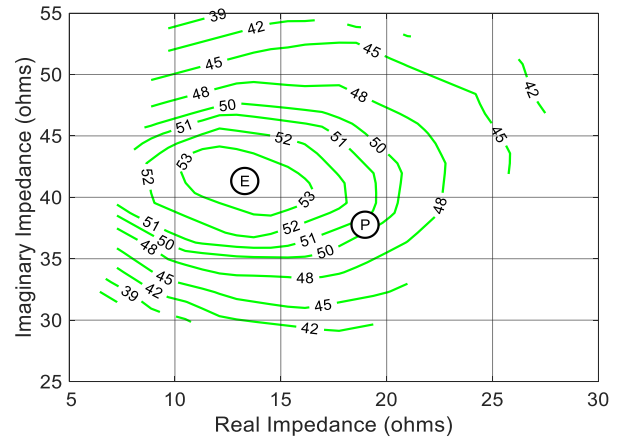

P2.5dB Loadpull Gain Contours (dB)

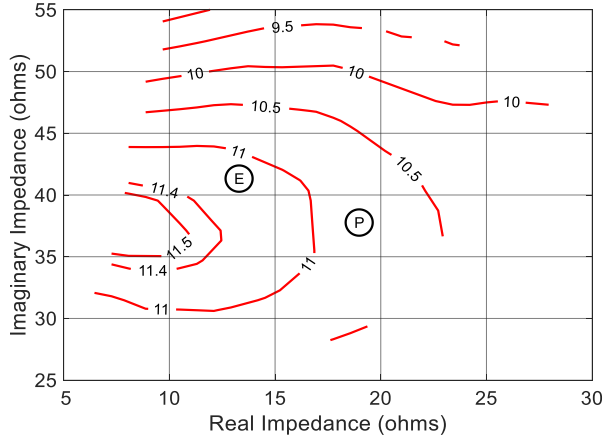

P2.5dB Loadpull AM/PM Contours (°)

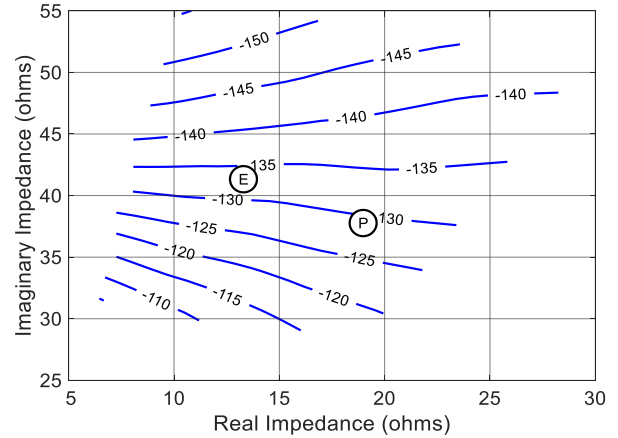

Gain vs. Output Power

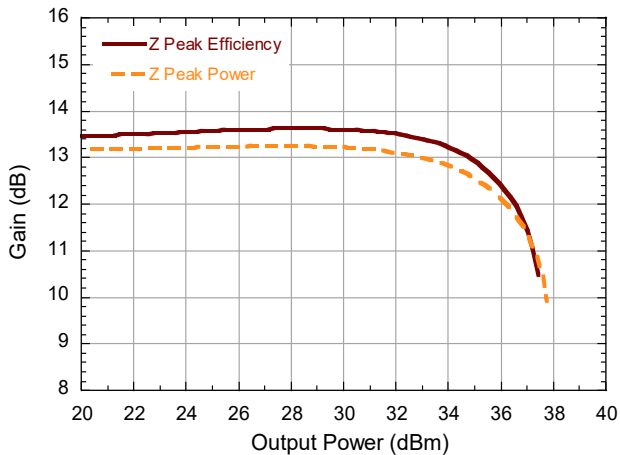

Drain Efficiency vs. Output Power

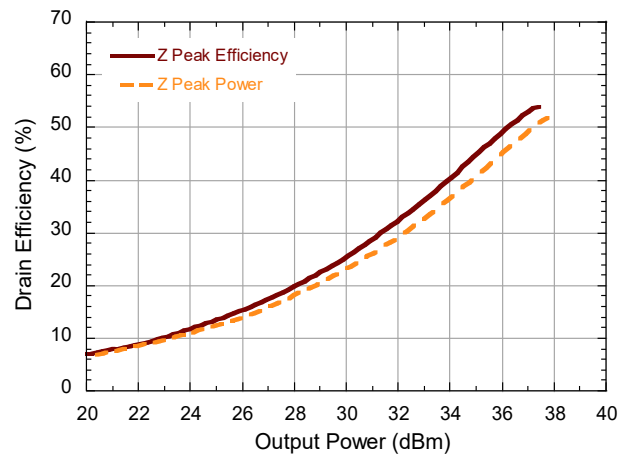

Pulsed⁴ Load-Pull Performance: Reference Plane at Device Leads

Frequency (GHz)	Z_{SOURCE} (Ω)	Maximum Output Power					
		$V_{DS} = 28\text{ V}, I_{DQ} = 20\text{ mA}, T_C = 25^\circ\text{C}, P_{2.5\text{ dB}}$					
		Z_{LOAD}^{11} (Ω)	Gain (dB)	P_{OUT} (dBm)	P_{OUT} (W)	η_D (%)	AM/PM ($^\circ$)
1	40.4 - j9.4	68.0 + j25.1	7.4	35.4	3.5	62.3	149.0
2	10.8 + j20.7	45.8 + j36.9	11.1	35.3	3.4	60.5	76.5
3	7.0 - j10.5	27.9 + j38.3	12.8	34.6	2.9	51.3	45.2
4	47.4 - j28.8	33.2 + j32.4	12.5	34.9	3.1	51.8	-35.2
5	18.6 + j0.9	23.4 + j24.9	9.4	34.6	2.9	48.5	-126.4

Frequency (GHz)	Z_{SOURCE} (Ω)	Maximum Drain Efficiency					
		$V_{DS} = 28\text{ V}, I_{DQ} = 20\text{ mA}, T_C = 25^\circ\text{C}, P_{2.5\text{ dB}}$					
		Z_{LOAD}^{12} (Ω)	Gain (dB)	P_{OUT} (dBm)	P_{OUT} (W)	η_D (%)	AM/PM ($^\circ$)
1	39.6 - j7.0	96.9 + j109.6	9.9	32.7	1.9	74.7	144.2
2	11.6 + j18.6	46.5 + j78.0	12.8	33.4	2.2	71.4	64.9
3	7.9 - j11.8	25.8 + j53.1	14.2	33.6	2.3	57.1	33.6
4	56.7 - j15.1	21.8 + j44.6	13.1	33.9	2.5	56.7	-50.5
5	18.0 + j1.8	15.7 + j33.4	9.7	33.7	2.3	53.9	-135.1

Impedance Reference

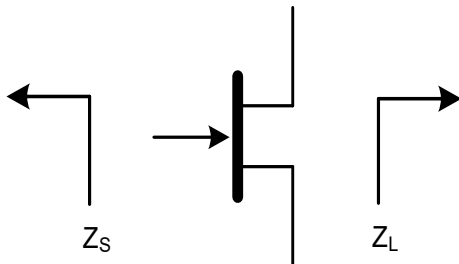

Z_{SOURCE} = Measured impedance presented to the input of the device at package reference plane.

Z_{LOAD} = Measured impedance presented to the output of the device at package reference plane.

- 11. Load Impedance for optimum output power.
- 12. Load Impedance for optimum efficiency.

Pulsed⁴ Load-Pull Performance 28 V, 1 GHz

P2.5dB Loadpull Output Power Contours (dBm)

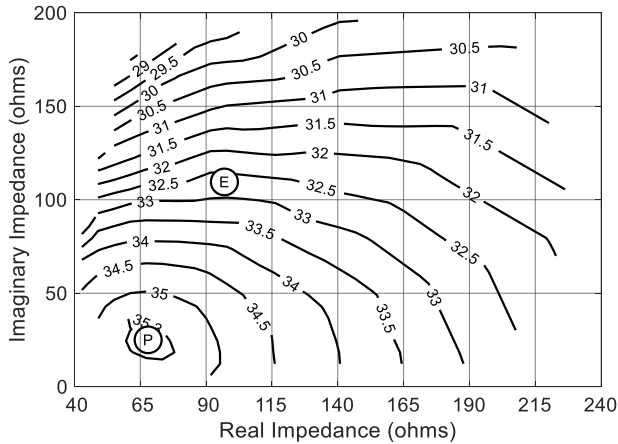

P2.5dB Loadpull Drain Efficiency Contours (%)

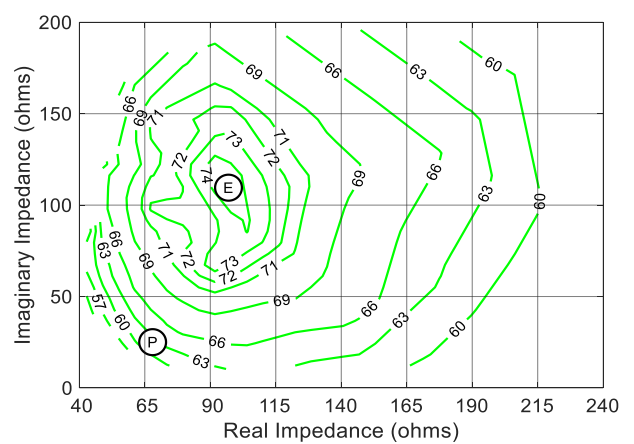

P2.5dB Loadpull Gain Contours (dB)

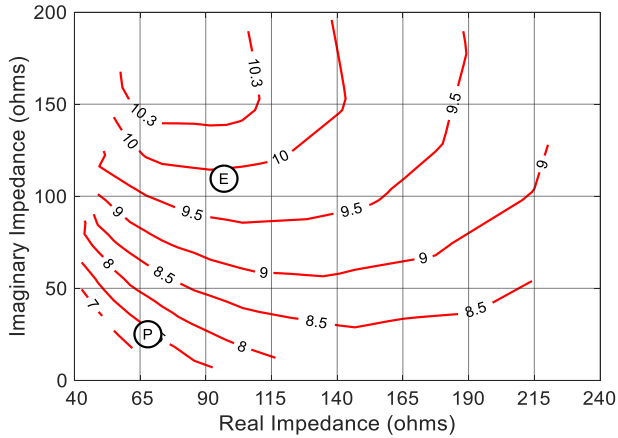

P2.5dB Loadpull AM/PM Contours (°)

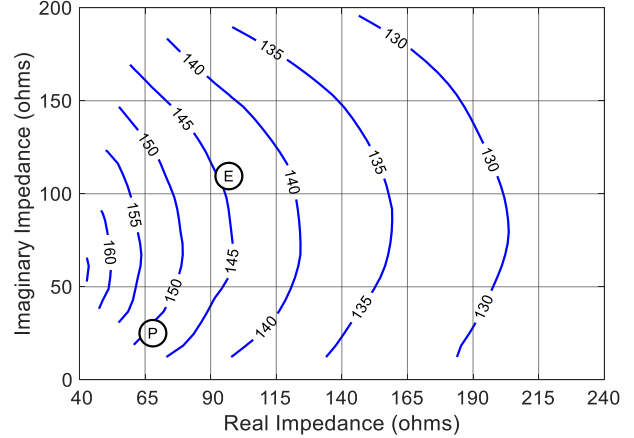

Gain vs. Output Power

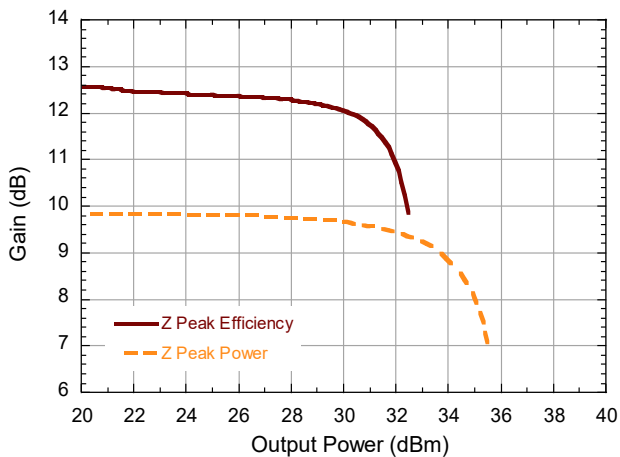

Drain Efficiency vs. Output Power

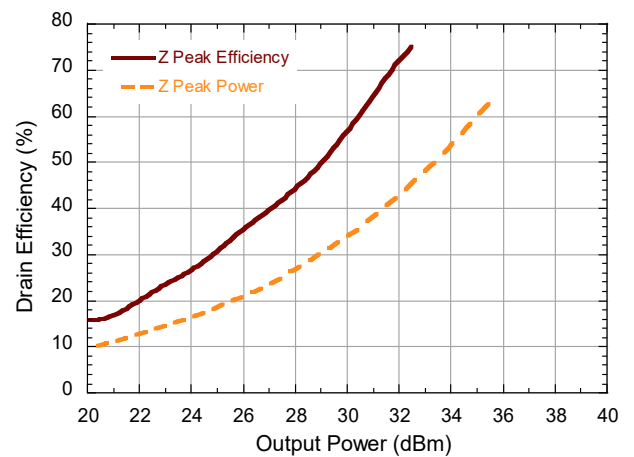

Pulsed⁴ Load-Pull Performance 28 V, 2 GHz

P2.5dB Loadpull Output Power Contours (dBm)

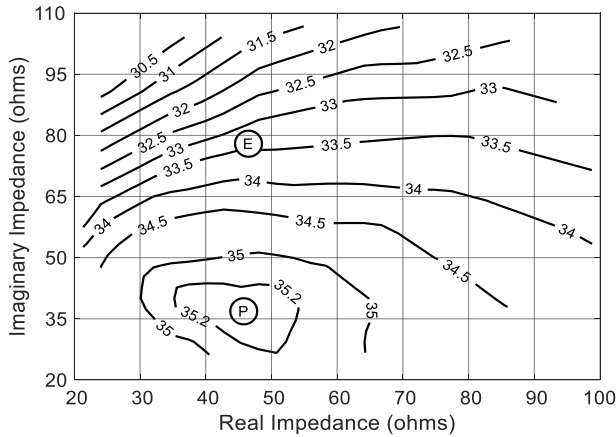

P2.5dB Loadpull Drain Efficiency Contours (%)

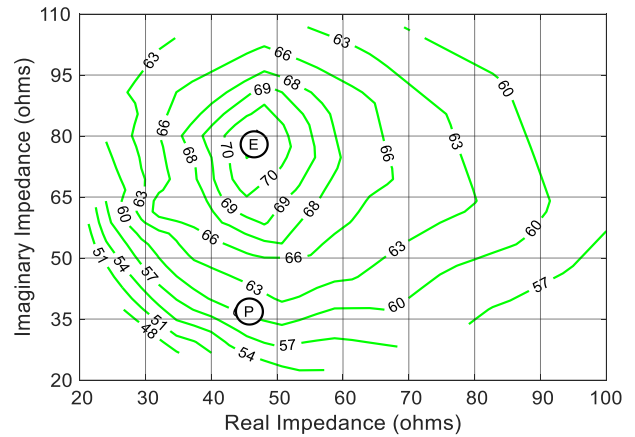

P2.5dB Loadpull Gain Contours (dB)

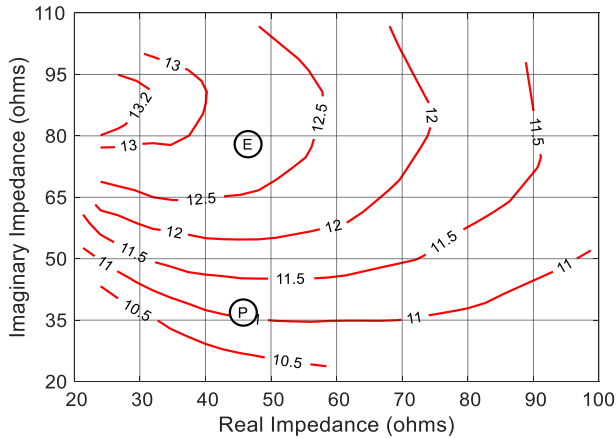

P2.5dB Loadpull AM/PM Contours (°)

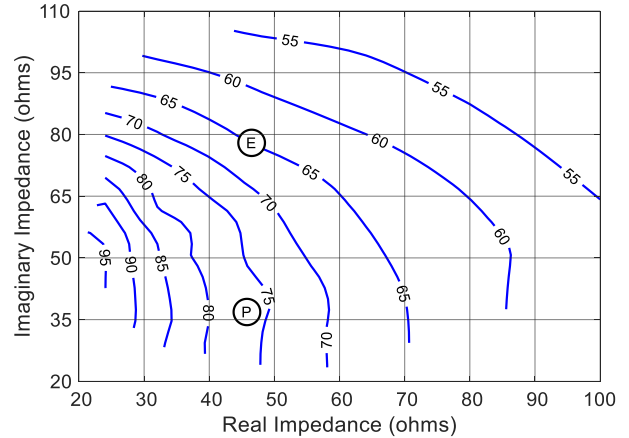

Gain vs. Output Power

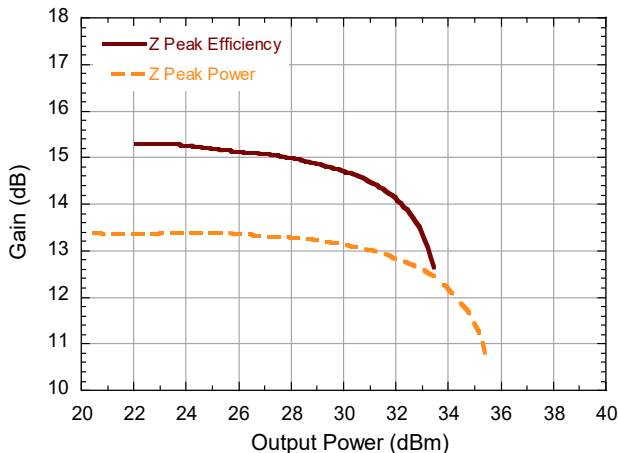

Drain Efficiency vs. Output Power

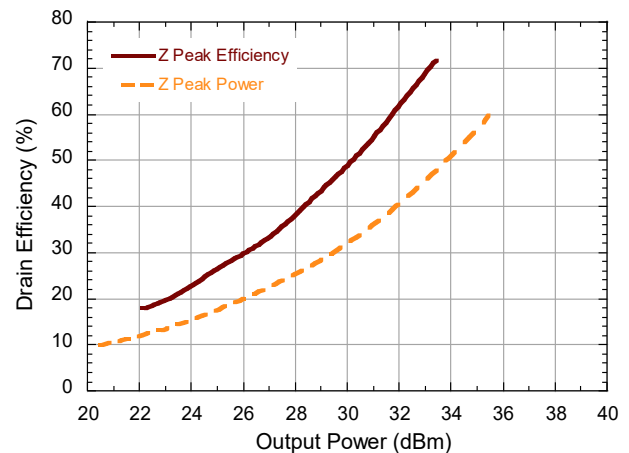

Pulsed⁴ Load-Pull Performance 28 V, 3 GHz

P2.5dB Loadpull Output Power Contours (dBm)

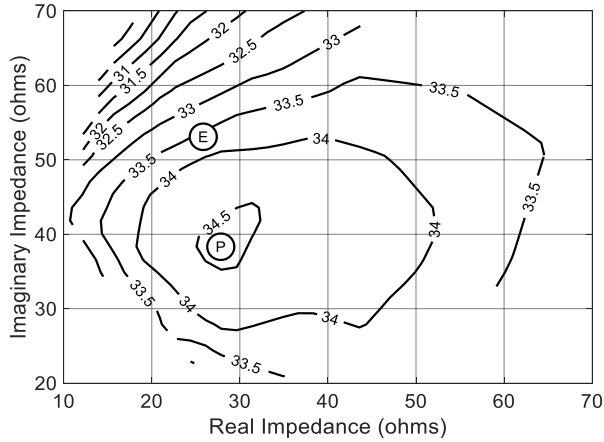

P2.5dB Loadpull Drain Efficiency Contours (%)

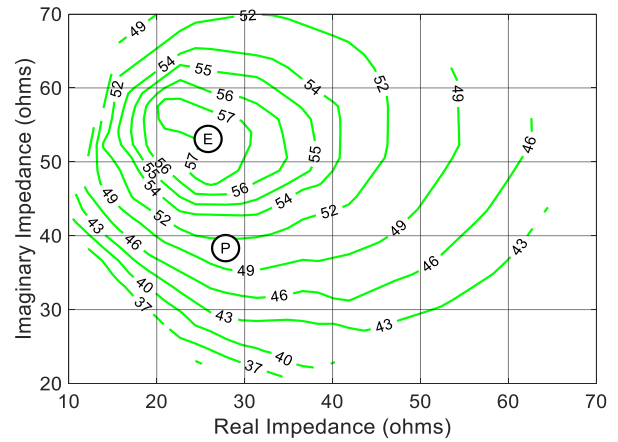

P2.5dB Loadpull Gain Contours (dB)

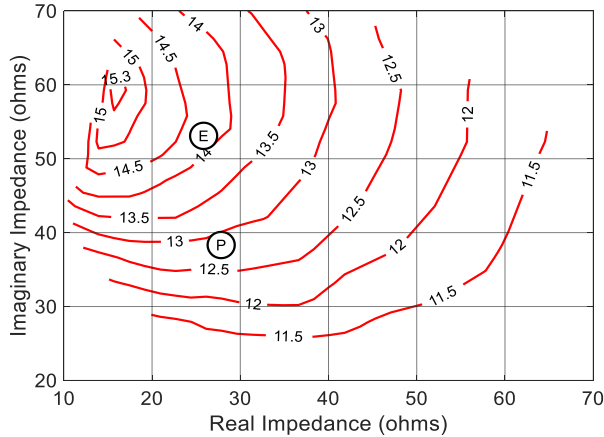

P2.5dB Loadpull AM/PM Contours (°)

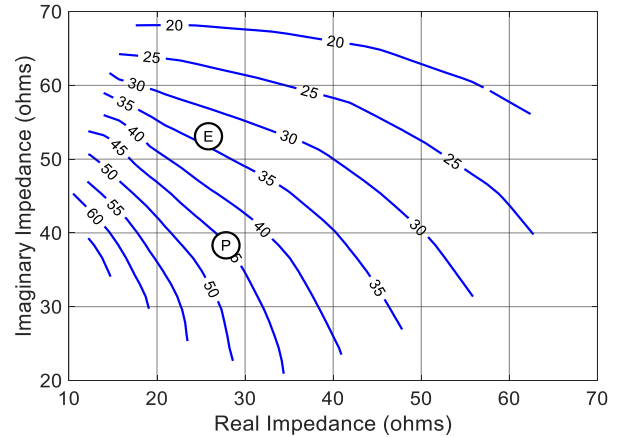

Gain vs. Output Power

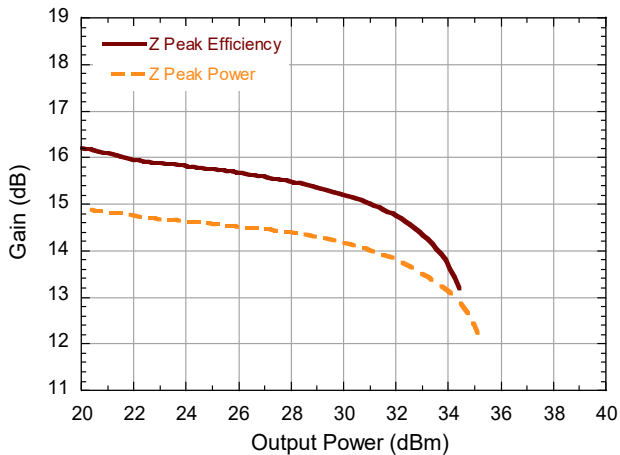

Drain Efficiency vs. Output Power

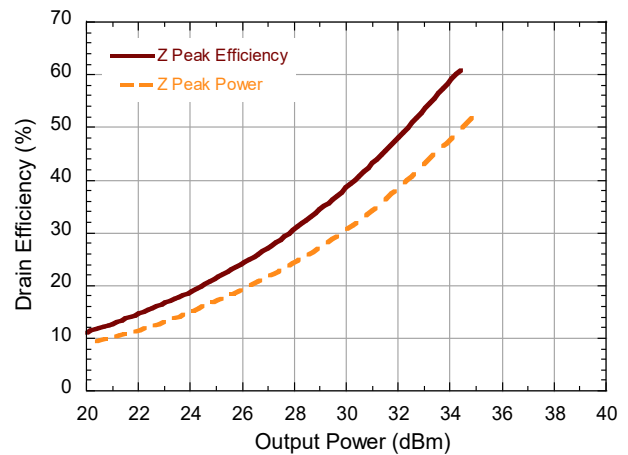

Pulsed⁴ Load-Pull Performance 28 V, 4 GHz

P2.5dB Loadpull Output Power Contours (dBm)

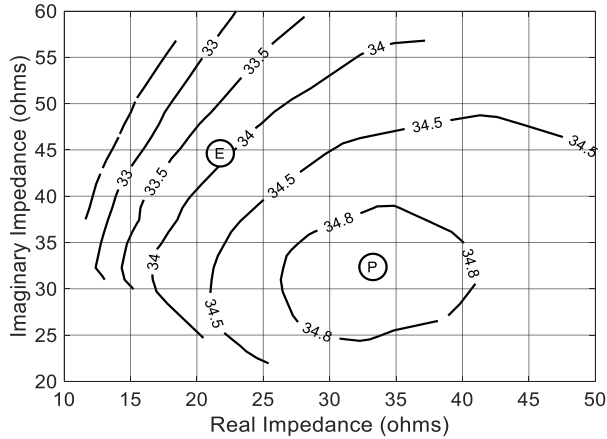

P2.5dB Loadpull Drain Efficiency Contours (%)

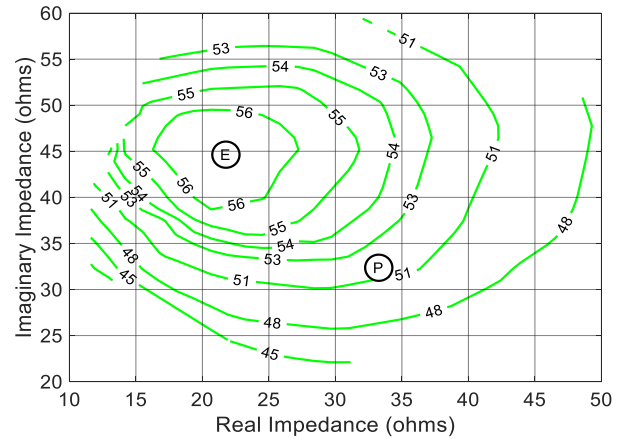

P2.5dB Loadpull Gain Contours (dB)

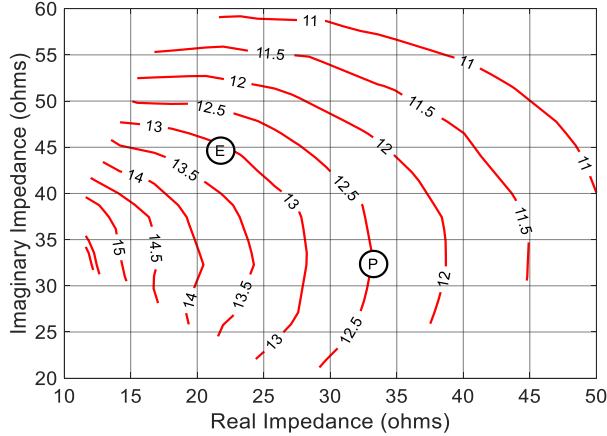

P2.5dB Loadpull AM/PM Contours (°)

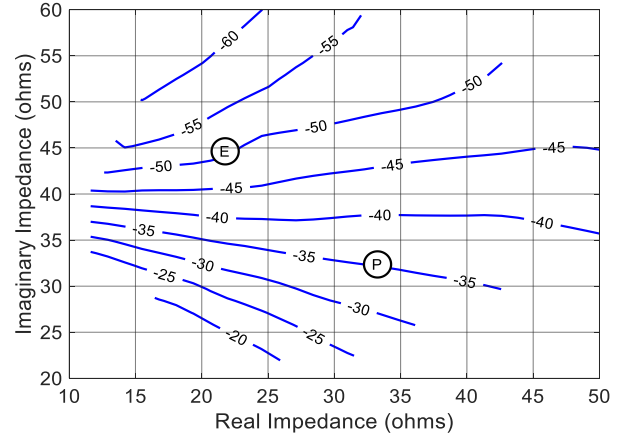

Gain vs. Output Power

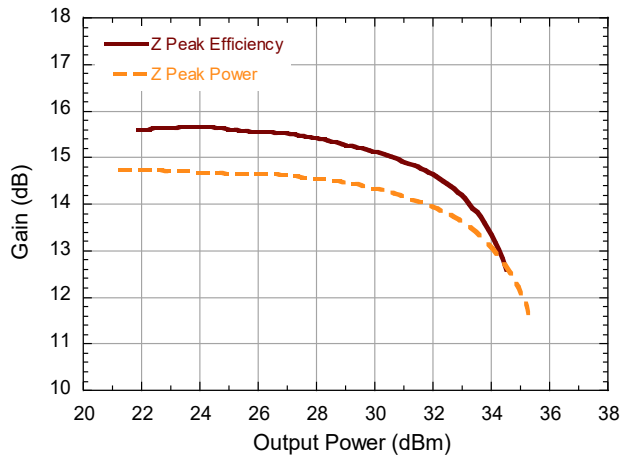

Drain Efficiency vs. Output Power

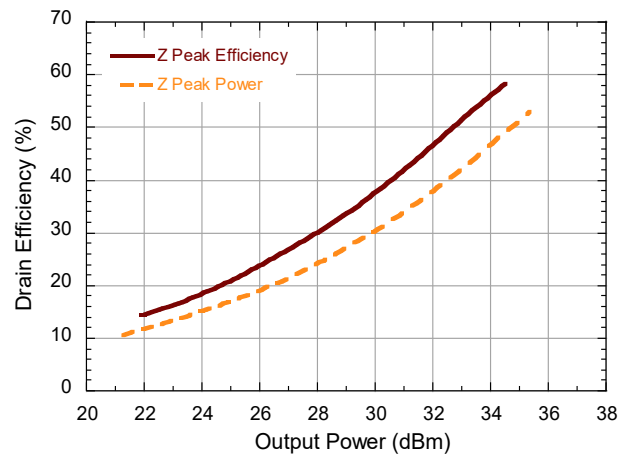

Pulsed⁴ Load-Pull Performance 28 V, 5 GHz

P2.5dB Loadpull Output Power Contours (dBm)

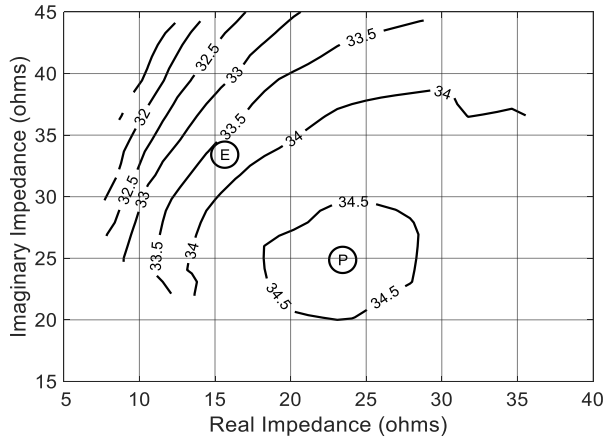

P2.5dB Loadpull Drain Efficiency Contours (%)

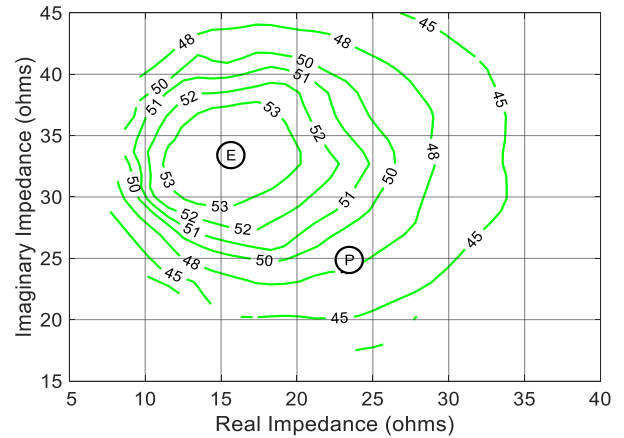

P2.5dB Loadpull Gain Contours (dB)

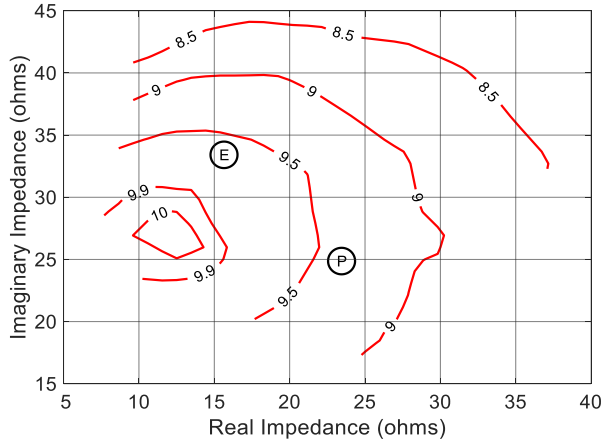

P2.5dB Loadpull AM/PM Contours (°)

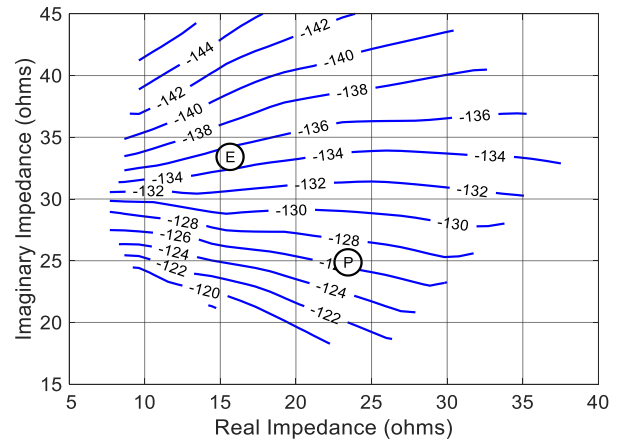

Gain vs. Output Power

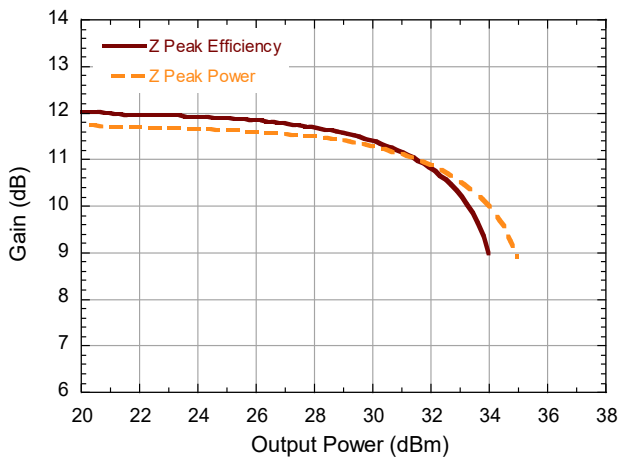

Drain Efficiency vs. Output Power

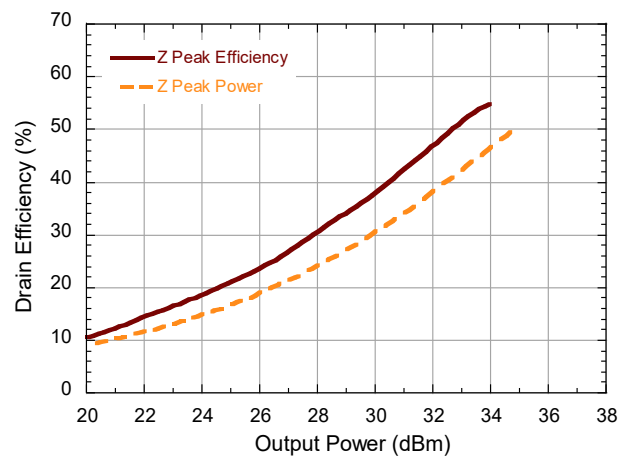

Evaluation Test Fixture and Recommended Tuning Solution 3.95 - 4.05 GHz

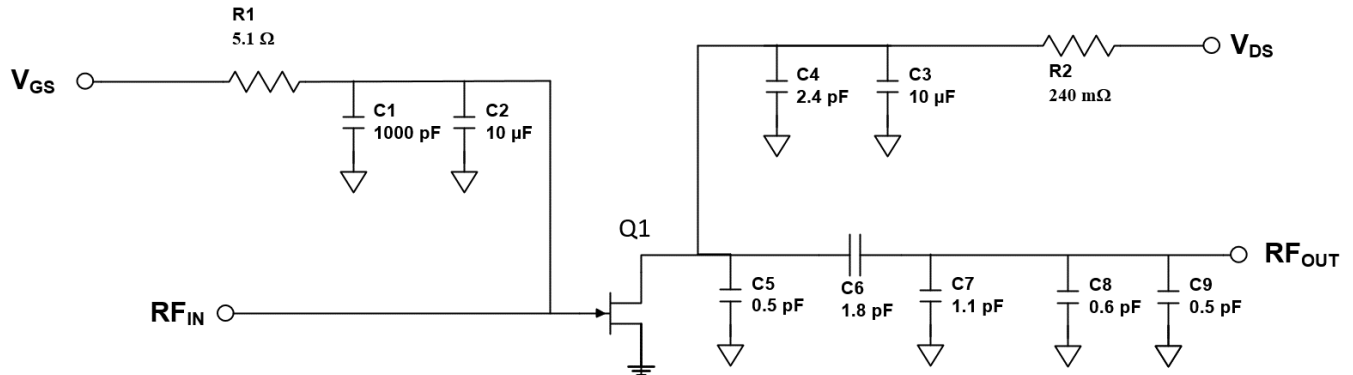

Description

Parts measured on evaluation board (20-mil thick RO4350). Matching is provided using a combination of lumped elements and transmission lines as shown in the simplified schematic above. Recommended tuning solution component placement, transmission lines, and details are shown on the next page.

Bias Sequencing

Turning the device ON

1. Set V_{GS} to pinch-off (V_P).
2. Turn on V_{DS} to nominal voltage (50 V).
3. Increase V_{GS} until I_{DS} current is reached.
4. Apply RF power to desired level.

Turning the device OFF

1. Turn the RF power OFF.
2. Decrease V_{GS} down to V_P pinch-off.
3. Decrease V_{DS} down to 0 V.
4. Turn off V_{GS} .

Evaluation Test Fixture and Recommended Tuning Solution 3.95 - 4.05 GHz

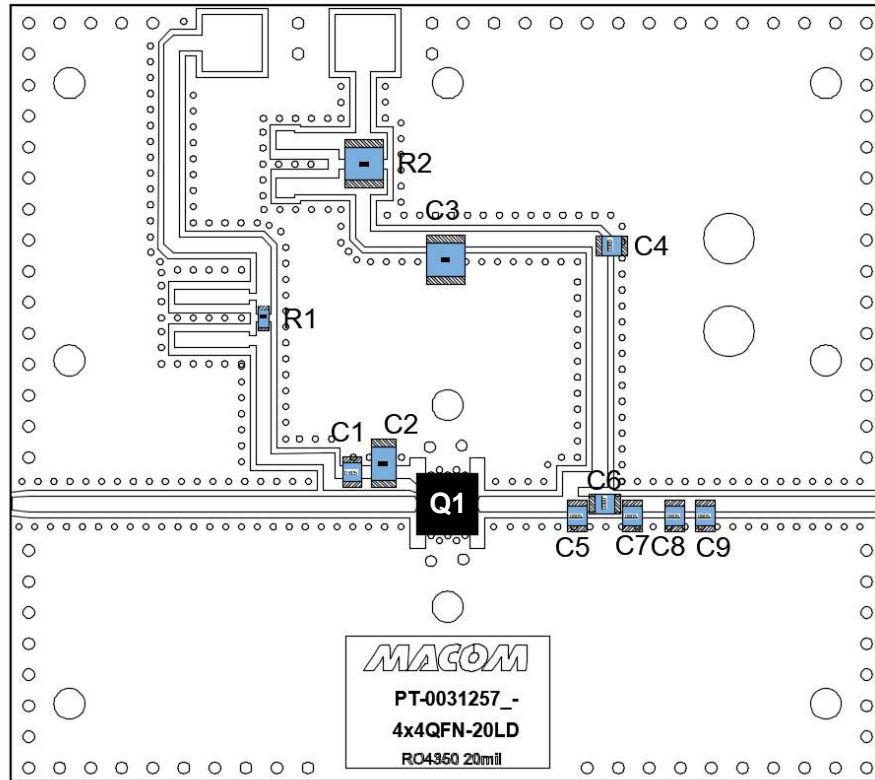

Reference Designator	Value	Tolerance	Manufacturer	Part Number
C1	1000 pF	+/- 5 %	Murata	GRM219R72A102JA01D
C2	10 μ F	+/- 5 %	Murata	GRM219R72A102JA01D
C3	10 μ F	+/- 10 %	Murata	GRM32EC72A106KE05L
C4	2.4 pF	+/- 0.1 pF	Murata	GQM2195C2E2R4BB12D
C5, C9	0.5 pF	+/- 0.1 pF	Murata	GQM2195C2ER50BB12D
C6	1.8 pF	+/- 0.1 pF	Murata	GQM2195C2E1R8BB12D
C7	1.1 pF	+/- 0.1 pF	Murata	GQM2195C2E1R1BB12D
C8	0.6 pF	+/- 0.1 pF	Murata	GQM2195C2ER60BB12D
R1	5.1 Ω	+/- 1 %	Vishay Dale	CRCW06035R10FKEA
R2	240 m Ω	+/- 1 %	Vishay Dale	RCWE1210R240FKEA
Q1	MACOM GaN Power Amplifier			MAGX-101050-002C0P
PCB	RO4350, 20 mil, 0.5 oz. Cu, SnPb Finish			

GaN Amplifier 50 V, 2 W

1 - 5 GHz



MAGX-101050-002C0P

Rev. V2

Typical Performance Curves as Measured in the 3.95 - 4.05 GHz Evaluation Test Fixture:
Pulsed⁴ 4 GHz, $V_{DS} = 50$ V, $I_{DQ} = 20$ mA, $T_C = 25^\circ\text{C}$ (Unless Otherwise Noted)

Gain vs. Output Power and Frequency

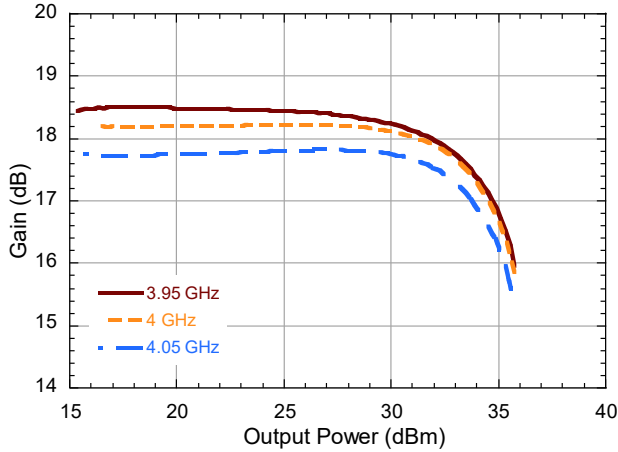

Drain Efficiency vs. Output Power and Frequency

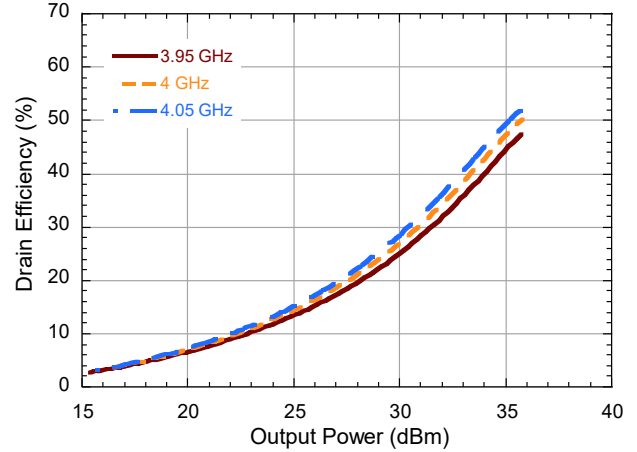

Gain vs. Output Power and V_{DS}

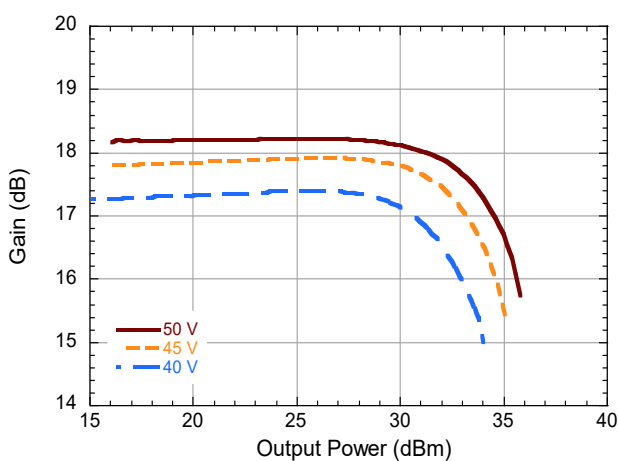

Drain Efficiency vs. Output Power and V_{DS}

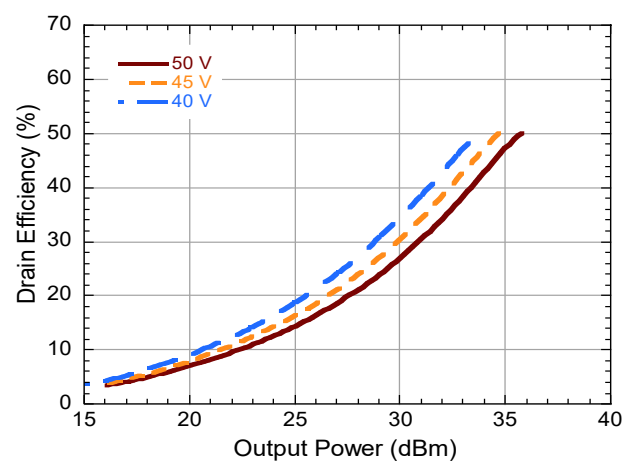

Gain vs. Output Power and I_{DQ}

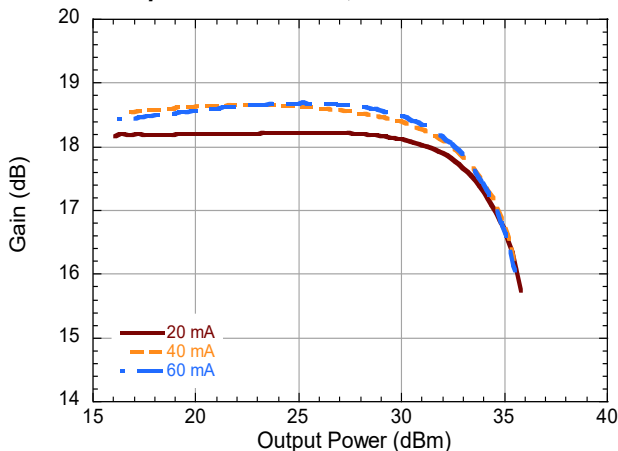

Drain Efficiency vs. Output Power and I_{DQ}

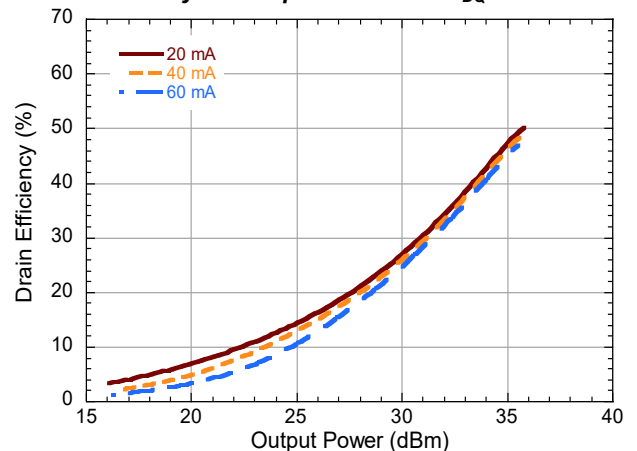

GaN Amplifier 50 V, 2 W 1 - 5 GHz



MAGX-101050-002C0P

Rev. V2

Typical Performance Curves as Measured in the 3.95 - 4.05 GHz Evaluation Test Fixture:
Pulsed⁴ 4 GHz, $V_{DS} = 50$ V, $I_{DQ} = 20$ mA, $T_C = 25^\circ\text{C}$ (Unless Otherwise Noted)

Gain vs. Output Power and T_C

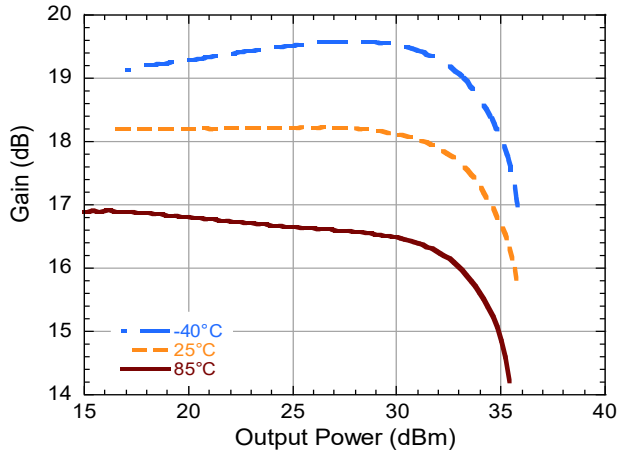

Drain Efficiency vs. Output Power and T_C

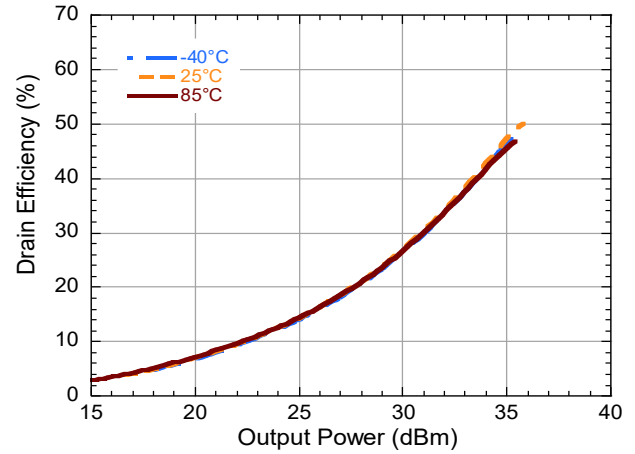

Gain vs. Frequency, 2.5dB Gain Compression

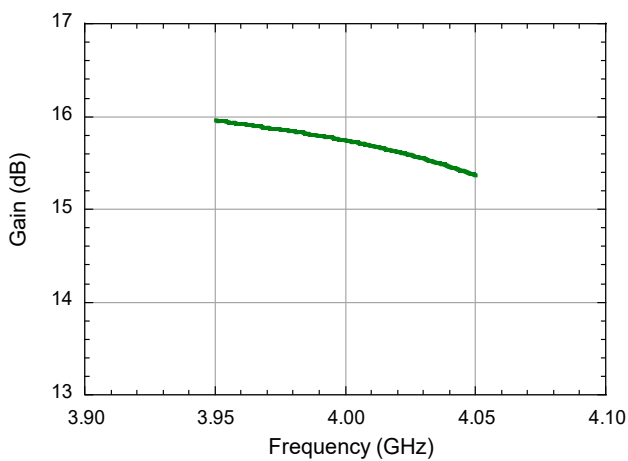

Drain Efficiency vs. Frequency, 2.5dB Gain Compression

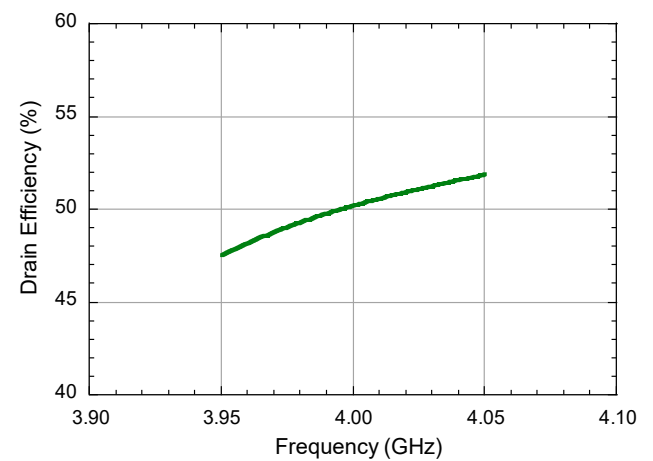

Output Power vs. Frequency, 2.5dB Gain Compression

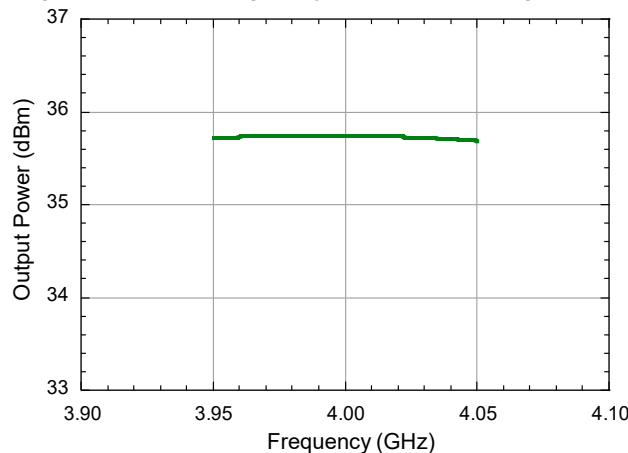

GaN Amplifier 50 V, 2 W 1 - 5 GHz



MAGX-101050-002C0P

Rev. V2

Lead-Free 4 mm 6-Lead Package Dimensions[†]

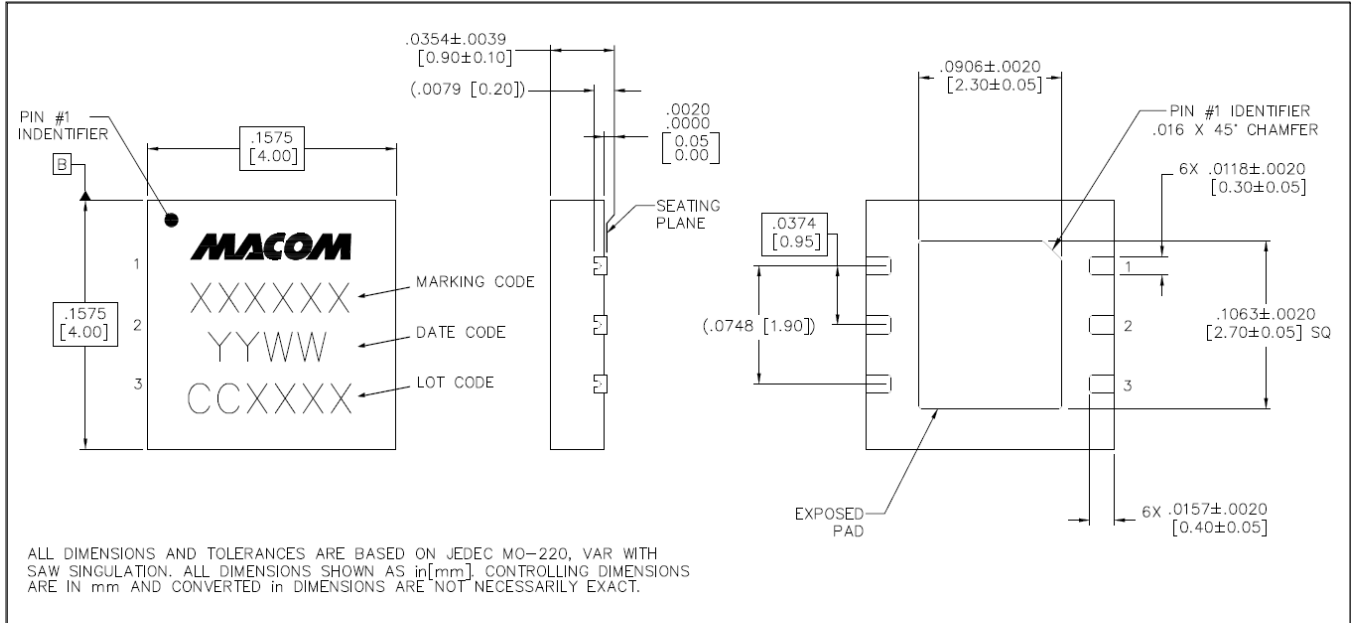

[†] Reference Application Note S2083 for lead-free solder reflow recommendations.
Meets JEDEC moisture sensitivity level (MSL) 3 requirements.
Plating is NiPdAu.

MACOM Technology Solutions Inc. ("MACOM"). All rights reserved.

These materials are provided in connection with MACOM's products as a service to its customers and may be used for informational purposes only. Except as provided in its Terms and Conditions of Sale or any separate agreement, MACOM assumes no liability or responsibility whatsoever, including for (i) errors or omissions in these materials; (ii) failure to update these materials; or (iii) conflicts or incompatibilities arising from future changes to specifications and product descriptions, which MACOM may make at any time, without notice. These materials grant no license, express or implied, to any intellectual property rights.

THESE MATERIALS ARE PROVIDED "AS IS" WITH NO WARRANTY OR LIABILITY, EXPRESS OR IMPLIED, RELATING TO SALE AND/OR USE OF MACOM PRODUCTS INCLUDING FITNESS FOR A PARTICULAR PURPOSE, MERCHANTABILITY, INFRINGEMENT OF INTELLECTUAL PROPERTY RIGHT, ACCURACY OR COMPLETENESS, OR SPECIAL, INDIRECT, INCIDENTAL, OR CONSEQUENTIAL DAMAGES WHICH MAY RESULT FROM USE OF THESE MATERIALS.

MACOM products are not intended for use in medical, lifesaving or life sustaining applications. MACOM customers using or selling MACOM products for use in such applications do so at their own risk and agree to fully indemnify MACOM for any damages resulting from such improper use or sale.