

# XCKM108

Limit switch, Limit switches XC Standard, XCKM, spring rod lever, 1NC+1 NO, snap action, Pg11



## Main

Range of Product	Telemecanique Limit switches XC Standard
Series name	Standard format
Product or Component Type	Limit switch
Device short name	XCKM
Body type	Fixed
Head type	Multi-directional head
Material	Metal
Body Material	Zamak
Fixing Mode	By the body
Movement of operating head	Multi-directional
Type of operator	Spring return spring rod
Type of approach	Multi-directional approach
Cable entry	3 entries tapped for Pg 11 cable gland
Number of poles	2
Contacts type and composition	1 NC + 1 NO
Contact operation	Snap action

## Complementary

Switch actuation	By any moving part
Electrical connection	Screw-clamp terminals 1 x 0.34...2 x 1.5 mm <sup>2</sup>
Contacts insulation form	Zb
Number of steps	1
Positive opening	Without
Minimum torque for tripping	1.15 lbf.in (0.13 N.m)
Minimum actuation speed	0.01 m/min
Maximum actuation speed	3.28 ft/s (1 m/s)
Contact code designation	A300, AC-15 (U <sub>e</sub> = 240 V), I <sub>e</sub> = 3 A EN/IEC 60947-5-1 appendix A Q300, DC-13 (U <sub>e</sub> = 250 V), I <sub>e</sub> = 0.27 A EN/IEC 60947-5-1 appendix A
[I <sub>th</sub> ] conventional enclosed thermal current	10 A AC
[U <sub>i</sub> ] rated insulation voltage	300 VUL 508 500 V 3)IEC 60947-1 300 VCSA C22.2 No 14
Maximum resistance across terminals	25 MOhm IEC 60255-7 category 3
[U <sub>imp</sub> ] rated impulse withstand voltage	6 KV IEC 60664 6 kV IEC 60947-1
Short-circuit protection	10 A cartridge fuse gG
Electrical durability	5000000 Cycles, DC-13, inductive, 120 V, 4 W 60 cyc/mn 0.5 IEC 60947-5-1 appendix C 5000000 Cycles, DC-13, inductive, 24 V, 7 W 60 cyc/mn 0.5 IEC 60947-5-1 appendix C 5000000 cycles, DC-13, inductive, 48 V, 10 W 60 cyc/mn 0.5 IEC 60947-5-1 appendix C
Width	2.52 in (64 mm)
Height	2.52 in (64 mm)

The information provided in this documentation contains general descriptions and/or technical characteristics of the products of the products contained herein. This documentation is not intended as a substitute for and is not to be used for determining suitability or reliability of these products for specific user applications. It is the duty of any such user or integrator to perform the appropriate and complete risk analysis, evaluation and testing of the products with respect to the relevant specific application or use thereof. Neither Schneider Electric Industries SAS nor any of its affiliates or subsidiaries shall be responsible or liable for misuse of the information contained herein.

Depth	1.18 in (30 mm)
Terminals description ISO n°1	(21-22)NC (13-14)NO

## Environment

Shock resistance	50 gn 11 ms EN/IEC 60068-2-27
Vibration resistance	25 gn 10...500 Hz)EN/IEC 60068-2-6
IP degree of protection	IP66 conforming to EN/IEC 60529
IK degree of protection	IK05 EN 50102
Electrical shock protection class	Class I IEC 61140 Class I NF C 20-030
Ambient air temperature for operation	-13...158 °F (-25...70 °C)
Ambient Air Temperature for Storage	-40...158 °F (-40...70 °C)
Protective treatment	TC
Product Certifications	CSA CCC UL
Standards	UL 508 EN 60204-1 CSA C22.2 No 14 IEC 60947-5-1 EN 60947-5-1 IEC 60204-1





## Ordering and shipping details

Category	22416 - LIMIT SWITCHES,IEC,XCKL
Discount Schedule	T
GTIN	3606485369556
Nbr. of units in pkg.	1
Package weight(Lbs)	9.88 oz (280 g)
Returnability	No
Country of origin	FR

## Packing Units

Unit Type of Package 1	PCE
Package 1 Height	1.26 in (3.2 cm)
Package 1 width	8.66 in (22 cm)
Package 1 Length	2.52 in (6.4 cm)

## Offer Sustainability

Sustainable offer status	Green Premium product
California proposition 65	WARNING: This product can expose you to chemicals including: Diisononyl phthalate (DINP), which is known to the State of California to cause cancer, and Di-isodecyl phthalate (DIDP), which is known to the State of California to cause birth defects or other reproductive harm. For more information go to <a href="http://www.P65Warnings.ca.gov">www.P65Warnings.ca.gov</a>
REACH Regulation	 <a href="#">REACH Declaration</a>
EU RoHS Directive	Pro-active compliance (Product out of EU RoHS legal scope)  <a href="#">EU RoHS Declaration</a>
Mercury free	Yes
RoHS exemption information	 <a href="#">Yes</a>
Environmental Disclosure	 <a href="#">Product Environmental Profile</a>

## Contractual warranty

Warranty	18 months
----------	-----------

Dimensions

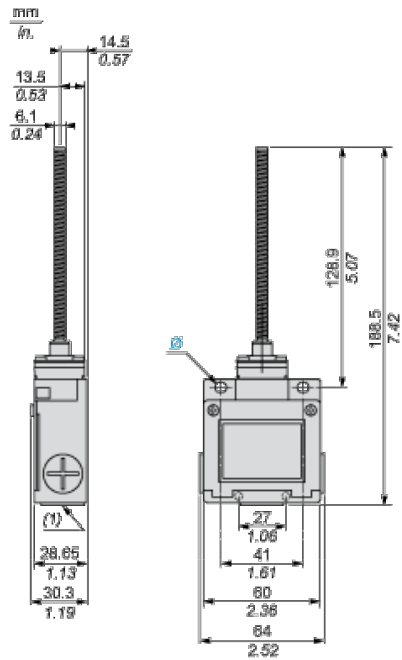

- (1) 3 tapped entries for Pg 11 cable gland  
Ø : 2 elongated holes Ø 5.2 x 6.2

---

Mounting with Cable Entry

---

Position of Cable Gland

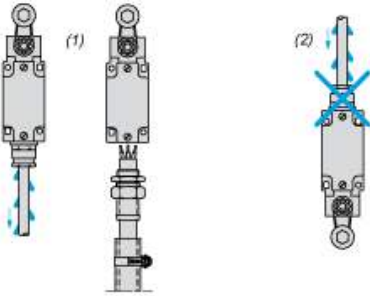

- (1) Recommended
- (2) To be avoided

---

## Wiring Diagram

---

2-pole NC + NO Snap Action

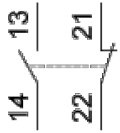

---

Characteristics of Actuation

---

Switch Actuation by Any Moving Part

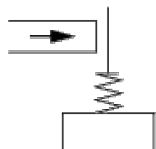

---

Functionnal Diagram

---

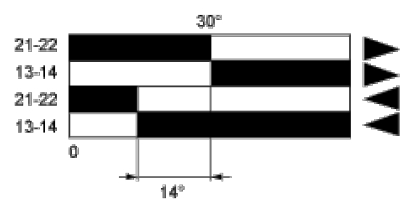

- (1) Closed
- (2) Open
- (3) Tripping
- (4) Resetting

- (1) Closed
- (2) Open
- (3) Tripping
- (4) Resetting