



**PIDG**

TE Internal #: 2-320572-3

Ring Terminals & Spade Terminals, Ring Tongue, 20 AWG Wire Size, .6 mm<sup>2</sup> Wire Size, 1186 CMA Wire Size, Stud Size M8 / 5/16, PIDG

[View on TE.com >](#)

Terminals & Splices > Ring Terminals & Spade Terminals > PIDG Ring Tongue Terminals



Ring & Spade Terminal Type: **Ring Tongue**

Wire Size: **1186 CMA**

Stud Size: **5/16, M8**

[All PIDG Ring Tongue Terminals \(421\)](#)

**Features**

**Product Type Features**

Stud Size	5/16, M8
Sealable	No
Wire Insulation Support Retention Type	Insulation Restriction

**Configuration Features**

Number of Holes	1
-----------------	---

**Electrical Characteristics**

Voltage Rating	300 V
----------------	-------

**Body Features**

Product Weight	1.051 g
Stripe Color	Red

**Contact Features**

Military Part Class	Class I
Ring & Spade Terminal Type	Ring Tongue



Barrel Type	Closed
Terminal Orientation	Straight
Terminal Plating Material	Tin

### Mechanical Attachment

Wire Insulation Support	With
-------------------------	------

### Dimensions

Wire Size	1186 CMA
Stud Diameter	7.92 mm[.312 in]
Tongue Thickness	.79 mm[.031 in]
Product Length	27.38 mm[1.078 in]
Compatible Insulation Diameter (Max)	2.79 mm[.11 in]
Compatible Insulation Diameter Range	1.17 – 2.79 mm[.046 – .11 in]

### Usage Conditions

Insulation Option	Partially Insulated
Operating Temperature Range	105 °C[221 °F]

### Operation/Application

Compatible With Wire Base Material	Copper
Compatible With Wire Plating Material	Tin

### Industry Standards

Government Qualified Terminal	Yes
-------------------------------	-----

### Packaging Features

Packaging Quantity	1000
Packaging Method	Loose Piece

### Product Compliance

[For compliance documentation, visit the product page on TE.com>](#)

EU RoHS Directive 2011/65/EU	Compliant
EU ELV Directive 2000/53/EC	Compliant
China RoHS 2 Directive MIIT Order No 32, 2016	No Restricted Materials Above Threshold
EU REACH Regulation (EC) No. 1907/2006	Current ECHA Candidate List: JUNE 2023 (235) Candidate List Declared Against: JUNE 2023 (235)



Does not contain REACH SVHC

Halogen Content

Low Halogen - Br, Cl, F, I < 900 ppm per homogenous material. Also BFR/CFR/PVC Free

Solder Process Capability

Not applicable for solder process capability

Product Compliance Disclaimer

This information is provided based on reasonable inquiry of our suppliers and represents our current actual knowledge based on the information they provided. This information is subject to change. The part numbers that TE has identified as EU RoHS compliant have a maximum concentration of 0.1% by weight in homogenous materials for lead, hexavalent chromium, mercury, PBB, PBDE, DBP, BBP, DEHP, DIBP, and 0.01% for cadmium, or qualify for an exemption to these limits as defined in the Annexes of Directive 2011/65/EU (RoHS2). Finished electrical and electronic equipment products will be CE marked as required by Directive 2011/65/EU. Components may not be CE marked. Additionally, the part numbers that TE has identified as EU ELV compliant have a maximum concentration of 0.1% by weight in homogenous materials for lead, hexavalent chromium, and mercury, and 0.01% for cadmium, or qualify for an exemption to these limits as defined in the Annexes of Directive 2000/53/EC (ELV). Regarding the REACH Regulation, the information TE provides on SVHC in articles for this part number is based on the latest European Chemicals Agency (ECHA) 'Guidance on requirements for substances in articles' posted at this URL: <https://echa.europa.eu/guidance-documents/guidance-on-reach>

## Compatible Parts



TE Part # 59170  
T-HEAD PIDG SH 26-14 ASSY



TE Part # 47386  
DAHT PG PIDG 26-16 ASSY



TE Part # 47386-4  
DAHT PG PIDG 26-16 ASSY



TE Part # 58433-3  
PRO CR ASSY, RBY IS9252



TE Part # 58423-1  
DIE, RBY IS9252



TE Part # 525690  
DAHT PG PIDG 20-18 ASSY



TE Part # 2063030-1  
SDE DIESET, RBY, UL



TE Part # 47806-2  
DIES PIDG 22-16 DIE SET



TE Part # 59300  
T-HEAD PIDG PG 26-16 ASSY



TE Part # 69344  
PIDG 26-22 DIE SET



TE Part # 1SET191001R0000  
CRIMP-HT



TE Part # 2392021-2  
RED BATTERY DAHT KIT 220V (47689-4)

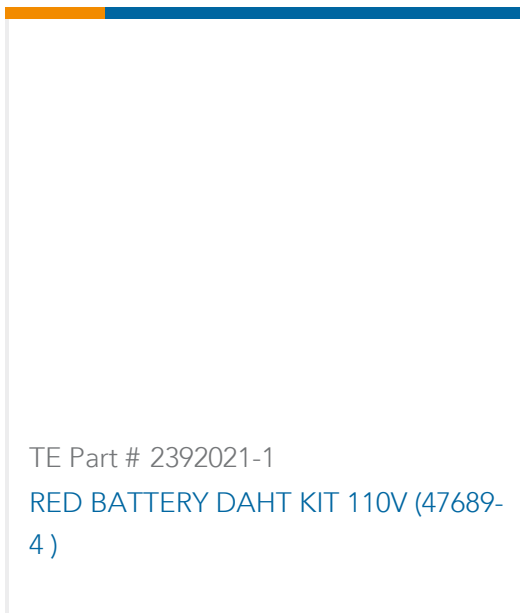

## Also in the Series | PIDG

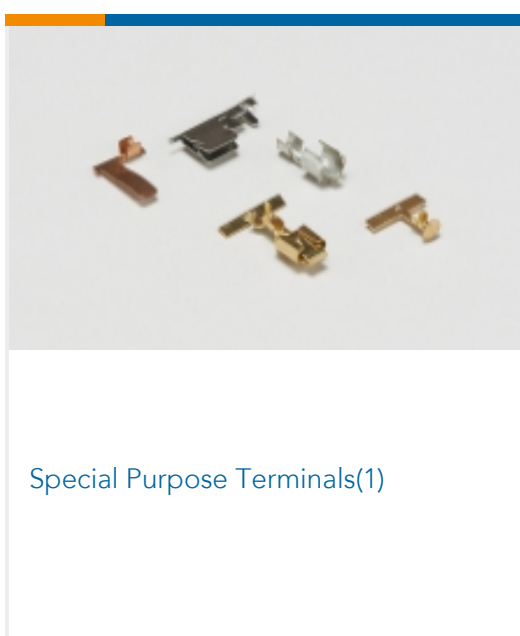
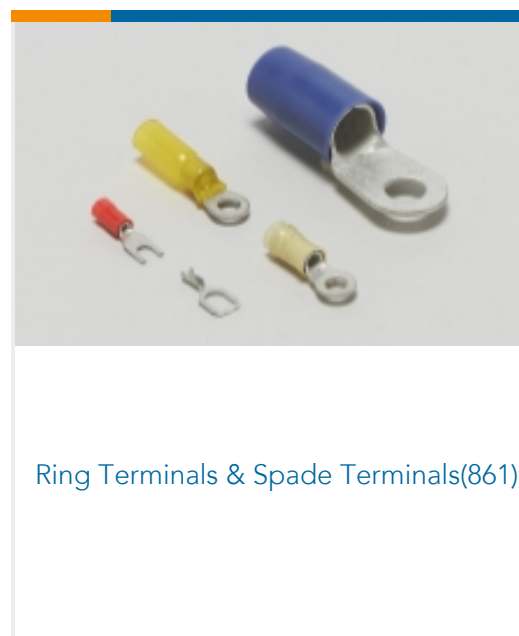
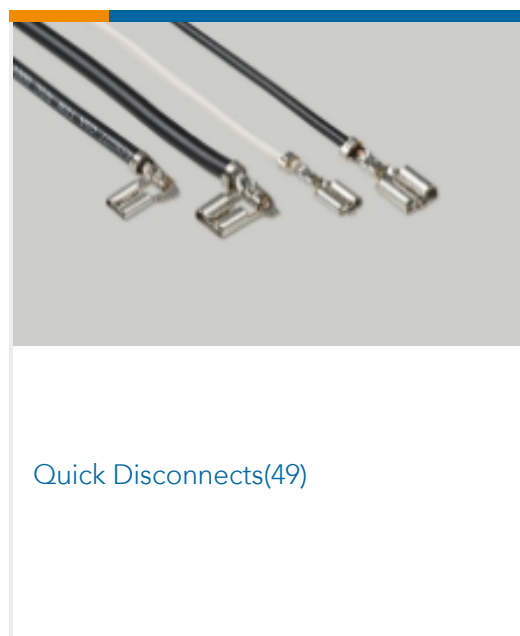
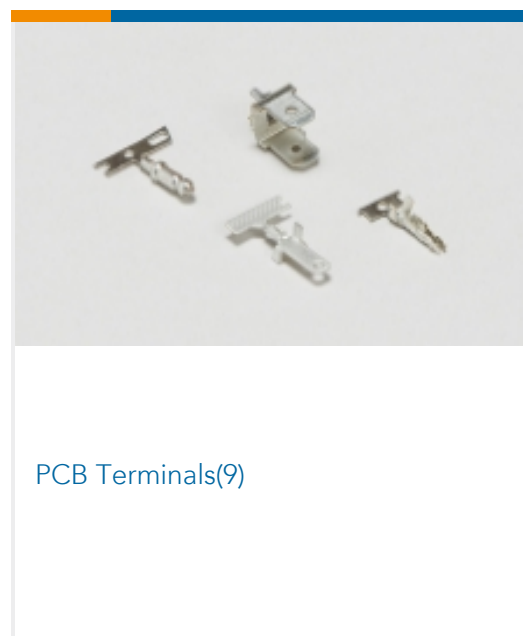
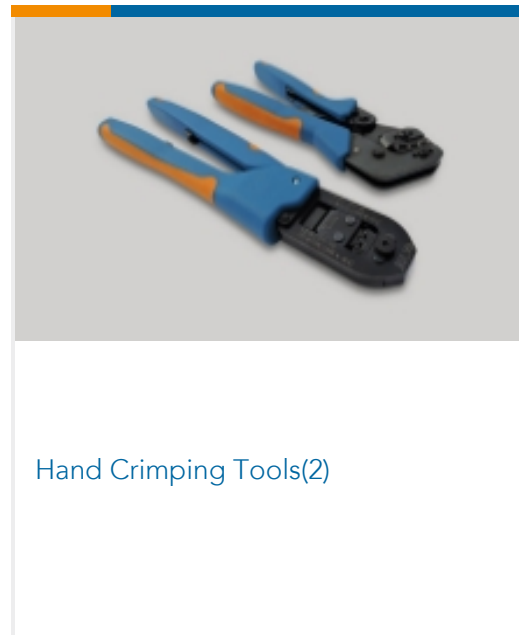
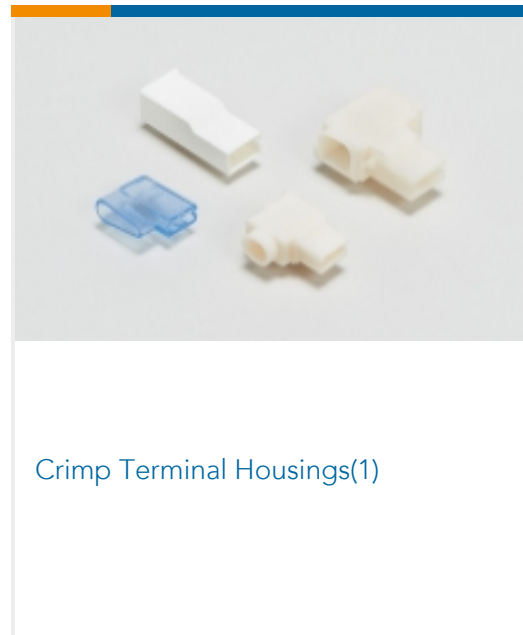
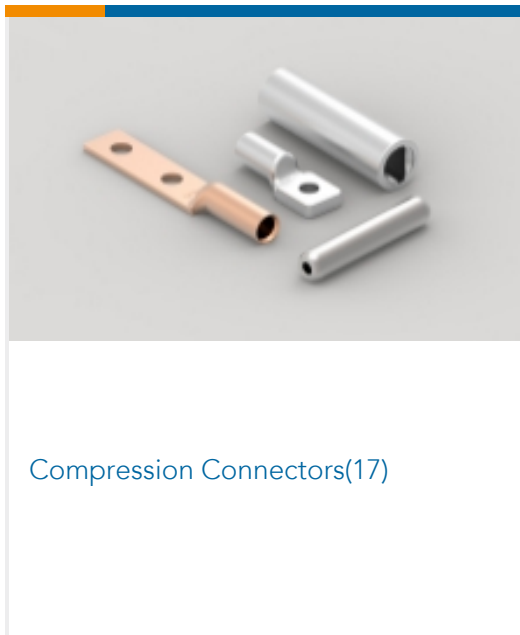

## Customers Also Bought

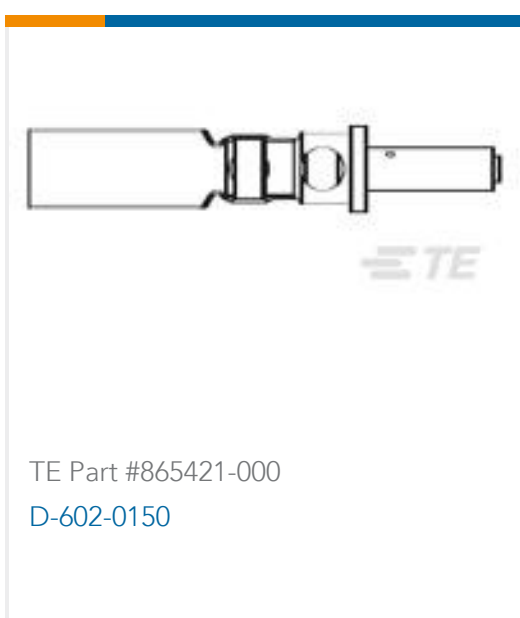

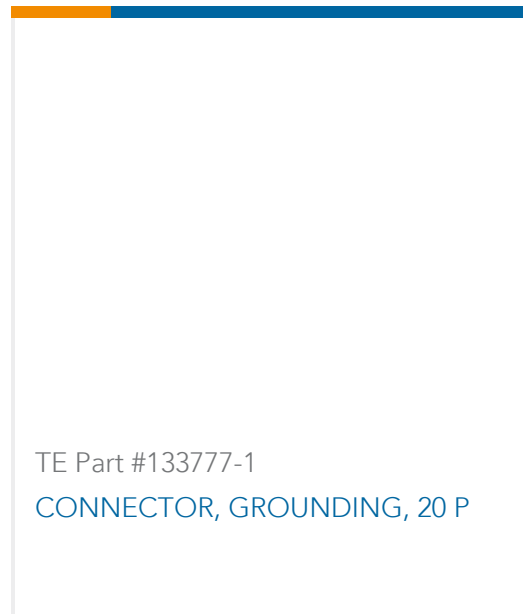
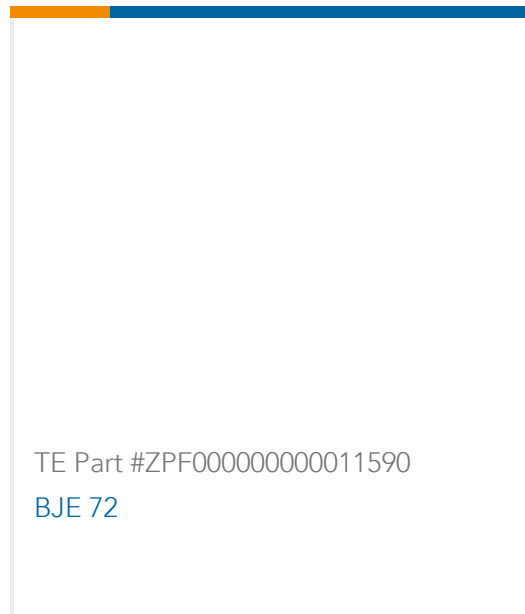
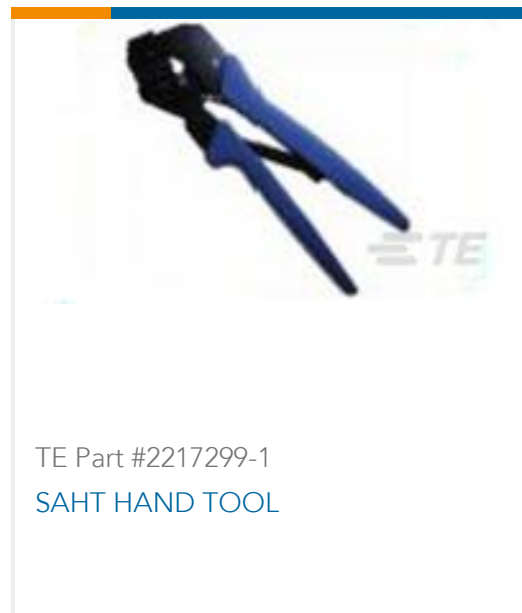

## Documents

### Product Drawings

[TERMINAL,PIDG R IR 20 5/16](#)

English

### CAD Files

[3D PDF](#)

3D

Customer View Model

[ENG\\_CVM\\_CVM\\_2-320572-3\\_AE.2d\\_dxf.zip](#)

English

Customer View Model

[ENG\\_CVM\\_CVM\\_2-320572-3\\_AE.3d\\_igs.zip](#)

English

Customer View Model

[ENG\\_CVM\\_CVM\\_2-320572-3\\_AE.3d\\_stp.zip](#)

English

By downloading the CAD file I accept and agree to the [Terms and Conditions](#) of use.

### Product Specifications

[Application Specification](#)

English

### Product Environmental Compliance

[TE Material Declaration](#)

English

### Agency Approvals

[CSA Certificate](#)



English