



# PC Card (PCMCIA) Interface Switch—12-V Suspend Capability

## FEATURES

- Programmable  $V_{CC}$  Ramp
- Smart Switching
- 12-V Sleepmode Compatible
- Extremely Low  $R_{ON}$
- Reverse Blocking Switches
- $V_{PP}$  Programmable to 0, 12-V or  $V_{CC}$
- Safe Power-Up
- Low Power Consumption
- PC Card 3-V/5-V Compatible
- Logic Compatible Inputs
- Single SO-16 Package

## DESCRIPTION

The Si9712 combines low on-resistance with slow ramp time and smart switching for overall best performance in integrated PC Card interface switches.

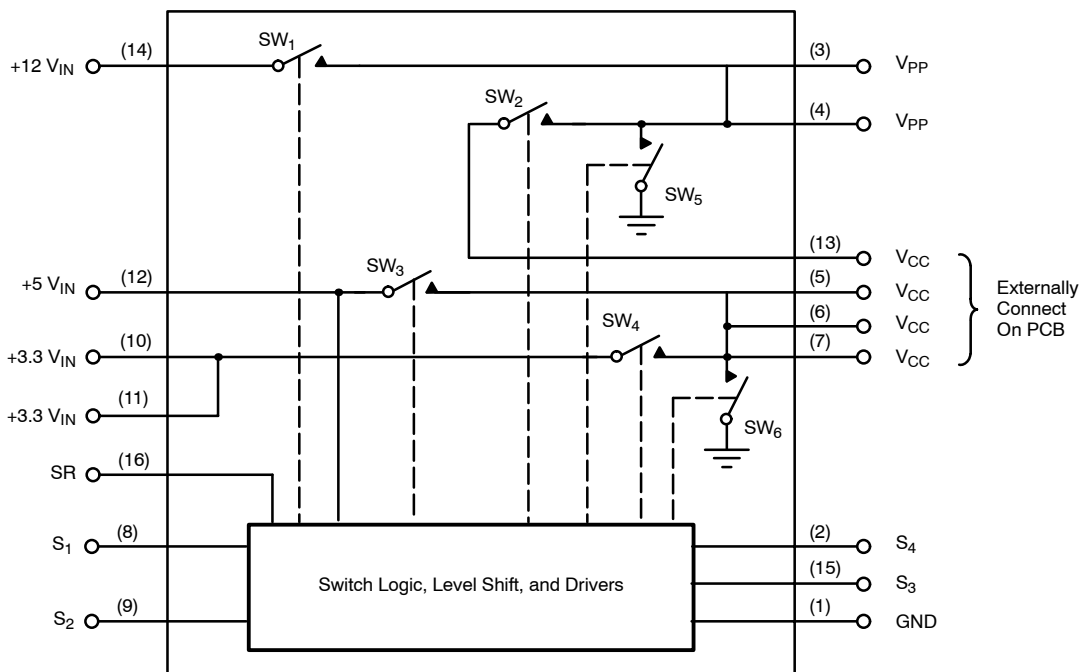
The Si9712 operates off the 5-V supply and has built-in level shifting for gate drive. Internal logic protects against an external control input error that would short 5 V to the 3.3-V supply. This protection logic also allows the Si9712 to be configured for positive or negative control logic for compatibility with a variety of PC Card controllers. These control inputs are CMOS logic compatible and can be driven to 3.3 V or 5 V.

The Si9712 complies with the release of the PC Card standard by supplying 0 V, 12 V, and  $V_{CC}$  to the  $V_{PP}$  output and 0 V, 3.3 V, and 5 V to the  $V_{CC}$  output. The  $V_{CC}$  ramp time is user programmable with an external capacitor connected to the SR pin.

The PC Card switch is packaged in a narrow body SO-16 package and is rated over the industrial temperature range  $-40$  to  $85^{\circ}\text{C}$ .

The Si9712 is available in both standard and lead (Pb)-free packages.

## FUNCTIONAL BLOCK DIAGRAM





## ABSOLUTE MAXIMUM RATINGS

Voltages Referenced to Ground

+12 V <sub>IN</sub>	15 V
+5 V <sub>IN</sub>	7 V
+3.3 V <sub>IN</sub> <sup>c</sup>	7 V
S <sub>1</sub> through S <sub>4</sub> (CMOS Inputs)	7 V
I <sub>OUT</sub> V <sub>PP</sub> <sup>a</sup>	300 mA
All Pins	-0.5 V
I <sub>OUT</sub> V <sub>CC</sub> <sup>b</sup>	4 A

PD Max: (T <sub>A</sub> = 25°C)	2.5 W
(T <sub>A</sub> = 85°C)	1.0 W
Junction Temperature	125°C
Thermal Rating—R <sub>ΘJA</sub>	40 °C/W

### Notes

- Pins 3, 4 connected together externally.
- Pins 5, 6, 7, 13 connected together externally.
- Pins 10, 11 connected together externally.

## RECOMMENDED OPERATING CONDITIONS

+12 V <sub>IN</sub>	0 or 12 V ± 10%
+5 V <sub>IN</sub> (must be present)	5 V ± 10%
+3.3 V <sub>IN</sub> <sup>c</sup>	3.3 V ± 10%
C <sub>SR</sub>	33 nF
I <sub>OUT</sub> V <sub>PP</sub> <sup>a</sup>	150 mA
I <sub>OUT</sub> V <sub>CC</sub> <sup>b</sup>	2 A

V <sub>PP</sub> Load Capacitance	10 μF Max
V <sub>CC</sub> Load Capacitance	150 μF Max

### Notes

- Pins 3, 4 connected together externally.
- Pins 5, 6, 7, 13 connected together externally.
- Pins 10, 11 connected together externally.

SPECIFICATIONS							
Parameter	Symbol	Test Conditions Unless Otherwise Specified		Limits -40 to 85°C			Unit
		C <sub>SR</sub> = 33 nF, +12 V <sub>IN</sub> = 12 V, +5 V <sub>IN</sub> = 5 V +3.3 V <sub>IN</sub> = 3.3 V, Low ≤ 0.8 V, High ≥ 2.2 V		Min <sup>a</sup>	Typ <sup>b</sup>	Max <sup>a</sup>	
<b>Switch 1</b>							
On-Resistance	R <sub>ON</sub>	I = 120 mA, +12 V <sub>IN</sub> = 11.4 V S <sub>3</sub> = S <sub>1</sub> = High S <sub>2</sub> = S <sub>4</sub> = Low	T <sub>A</sub> = 25°C			120	mΩ
			T <sub>A</sub> = 85°C			145	
Off Current (+12 V <sub>IN</sub> )	I <sub>OFF</sub>	+12 V <sub>IN</sub> = 12.6 V S <sub>1</sub> = Low	T <sub>A</sub> = 25°C			1	μA
			T <sub>A</sub> = 85°C			10	
Switching Time	t <sub>SW1(on)</sub>	S <sub>2</sub> = S <sub>4</sub> = Low, See Figure 1 S <sub>3</sub> = High		50	200	350	μs
	t <sub>SW1(off)</sub>				1.0	10	
Delay Time	t <sub>d(on)</sub>	See Figure 3 S <sub>2</sub> = S <sub>4</sub> = Low		1.0	6	20	ms
	t <sub>d(off)</sub>			0.1	2.9	10	
Rise Time	t <sub>SW1(on)</sub>	S <sub>2</sub> = S <sub>4</sub> = Low, S <sub>3</sub> = High, See Figure 2		50	150	300	μs
<b>Switch 2</b>							
On-Resistance	R <sub>ON</sub>	I = 120 mA, S <sub>2</sub> = S <sub>3</sub> = High S <sub>1</sub> = S <sub>4</sub> = Low	T <sub>A</sub> = 25°C			150	mΩ
			T <sub>A</sub> = 85°C			180	
Switching Time	t <sub>SW2(on)</sub>	S <sub>1</sub> = S <sub>4</sub> = Low, S <sub>3</sub> = High, See Figure 1		50	200	350	μs
	t <sub>SW2(off)</sub>				1.0	10	
Delay Time	t <sub>d(on)</sub>	S <sub>1</sub> = S <sub>4</sub> = Low, See Figure 3		1.0	6	20	ms
	t <sub>d(off)</sub>			0.1	1.7	10	
Rise Time	t <sub>SW2(on)</sub>	S <sub>1</sub> = S <sub>4</sub> = Low, S <sub>3</sub> = High, See Figure 2		50	150	300	μs
<b>Switch 3</b>							
On-Resistance	R <sub>ON</sub>	I = 500 mA, S <sub>3</sub> = High S <sub>1</sub> = S <sub>2</sub> = S <sub>4</sub> = Low	T <sub>A</sub> = 25°C			70	mΩ
			T <sub>A</sub> = 85°C			95	
Off Current (V <sub>CC</sub> )	I <sub>OFF</sub>	+5 V <sub>IN</sub> = 5.5 V, V <sub>CC</sub> = 0 V S <sub>1</sub> = S <sub>2</sub> = S <sub>3</sub> = Low S <sub>4</sub> = High +3.3 V <sub>IN</sub> = Open Circuit	T <sub>A</sub> = 25°C			1	μA
			T <sub>A</sub> = 85°C			10	
Rise Time	t <sub>SW3(on)</sub>	S <sub>1</sub> = S <sub>2</sub> = S <sub>4</sub> = Low, See Figure 2		0.1	1.7	10	ms
Fall Time	t <sub>SW3(off)</sub>			3	30	50	

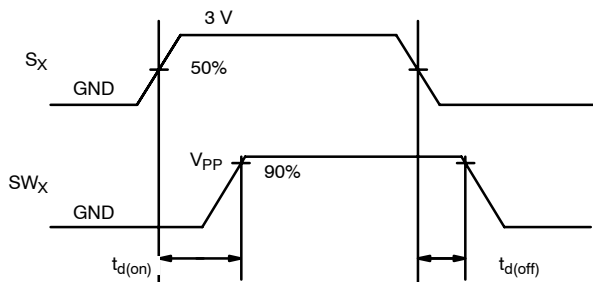


SPECIFICATIONS							
Parameter	Symbol	Test Conditions Unless Otherwise Specified $C_{SR} = 33 \text{ nF}$ , $+12 \text{ V}_{IN} = 12 \text{ V}$ , $+5 \text{ V}_{IN} = 5 \text{ V}$ $+3.3 \text{ V}_{IN} = 3.3 \text{ V}$ , Low $\leq 0.8 \text{ V}$ , High $\geq 2.2 \text{ V}$	Limits -40 to 85°C			Unit	
			Min <sup>a</sup>	Typ <sup>b</sup>	Max <sup>a</sup>		
<b>Switch 4</b>							
On-Resistance	$R_{ON}$	$I = 500 \text{ mA}$ , $S_4 = \text{High}$ $S_1 = S_2 = S_3 = \text{Low}$	$T_A = 25^\circ\text{C}$			50	mΩ
			$T_A = 85^\circ\text{C}$			70	
Off Current (+3.3 V <sub>IN</sub> )	$I_{OFF}$	$+3.3 \text{ V}_{IN} = 3.6 \text{ V}$ , $S_1 = S_2 = S_3 = S_4 = \text{Low}$	$T_A = 25^\circ\text{C}$			1	μA
			$T_A = 85^\circ\text{C}$			10	
Rise Time	$t_{SW4(on)}$	$S_1 = S_2 = S_3 = \text{Low}$ , See Figure 2		0.1	0.9	10	ms
Fall Time	$t_{SW4(off)}$			3	20	40	
<b>Switch 5</b>							
On-Resistance	$R_{ON}$	$I = 2 \text{ mA}$ , $S_1 = S_2 = \text{Low}$	$T_A = 25^\circ\text{C}$		235	400	Ω
			$T_A = 85^\circ\text{C}$		325	550	
<b>Switch 6</b>							
On-Resistance	$R_{ON}$	$I = 2 \text{ mA}$ , $S_3 = S_4 = \text{Low}$	$T_A = 25^\circ\text{C}$		140	400	Ω
			$T_A = 85^\circ\text{C}$		200	500	
<b>Power Supply</b>							
+5 V <sub>IN</sub> Current Input (on)	$I_{+5VIN(1)}$	$S_1 = S_4 = 0 \text{ V}$ , $S_2 = S_3 = 3 \text{ V}$			20	50	μA
	$I_{+5VIN(2)}$	$S_1 = S_4 = 3 \text{ V}$ , $S_2 = S_3 = 0 \text{ V}$			20	50	
+5 V <sub>IN</sub> Current Input (off)	$I_{+5VIN(3)}$	$S_1 = S_2 = S_3 = S_4 = 0 \text{ V}$			<1	10	
<b>Switch Control Inputs</b>							
Input Voltage High	$V_{I(H)}$		$+5 \text{ V}_{IN} = 5.5 \text{ V}$	2.2	1.8		V
			$+5 \text{ V}_{IN} = 4.5 \text{ V}$	2.2	1.6		
Input Voltage Low	$V_{I(L)}$		$+5 \text{ V}_{IN} = 5.5 \text{ V}$		1.6	0.8	
			$+5 \text{ V}_{IN} = 4.5 \text{ V}$		1.4	0.8	
Input Current High	$I_{I(H)}$	$S_1$ through $S_4 = 5 \text{ V}$				1.0	μA
Input Current Low	$I_{I(L)}$	$S_1$ through $S_4 = \text{GND}$		-1.0			

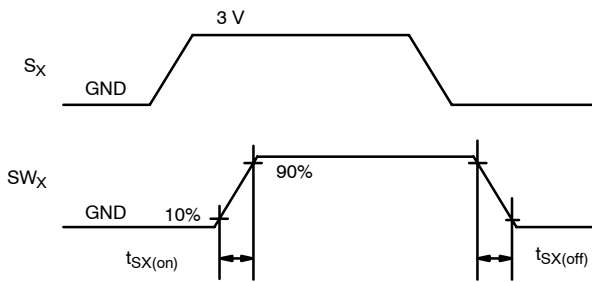
Notes

- a. The algebraic convention whereby the most negative value is a minimum and the most positive a maximum.
- b. Typical values are for DESIGN AID ONLY, not guaranteed nor subject to production testing.

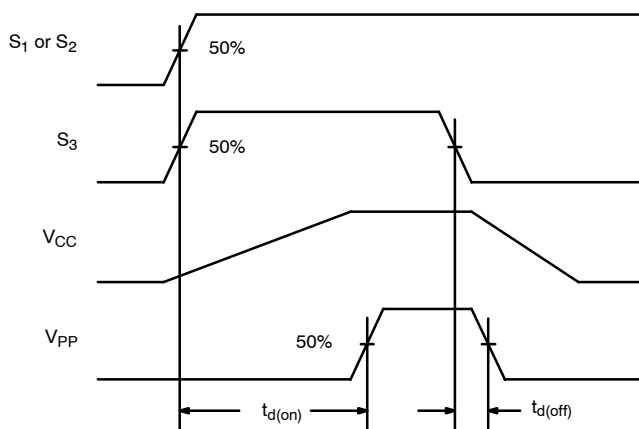
**TIMING WAVEFORMS**



**FIGURE 1.**  $V_{PP}$  Switch Delay

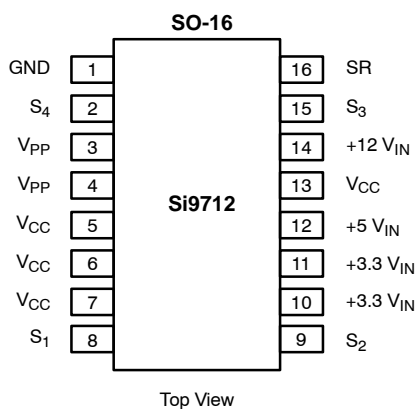


**FIGURE 2.** Switch Ramp



**FIGURE 3.** Delay from  $S_1$  or  $S_2$  to  $V_{PP}$  Power-up

**PIN CONFIGURATION AND DESCRIPTION**



Note: Pins 5, 6, 7, and 13 must be connected in the PCB for correct operation.

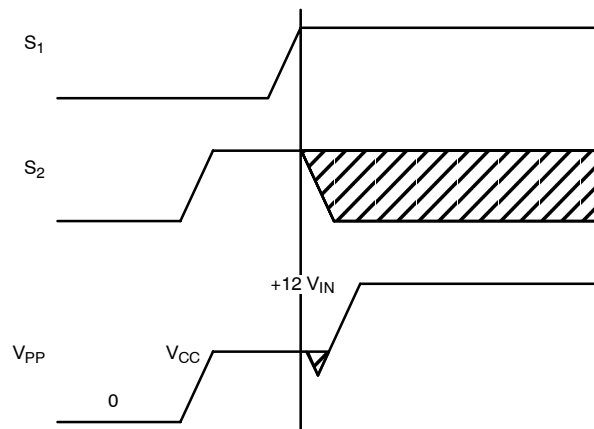
Pin Number	Function	Description
1.	GND	Ground connection.
2	$S_4$	Control input for selecting +3.3 $V_{IN}$ to $V_{CC}$ . The PC Card terminology for this pin is $V_{CC\_EN0}$ .
3, 4	$V_{PP}$	Program and peripheral voltage to PC Card slot.
5, 6, 7, 13	$V_{CC}$	Supply voltage to slot.
8	$S_1$	Control input for selecting +12 $V_{IN}$ to $V_{PP}$ . The PC Card terminology for this pin is $V_{PP\_EN1}$ .
9	$S_2$	Control input for selecting $V_{CC}$ to $V_{PP}$ . The PC Card terminology for this pin is $V_{PP\_EN0}$ .
10, 11	+3.3 $V_{IN}$	+3.3-V supply.
12	+5 $V_{IN}$	+5-V supply.
14	+12 $V_{IN}$	+12-V supply.
15	$S_3$	Control input for selecting +5 $V_{IN}$ to $V_{CC}$ . The PC Card terminology for this pin is $V_{CC\_EN1}$ .
16	SR	Slew rate control pin, capacitor to GND defines programmable ramp time.

<b>ORDERING INFORMATION</b>		
<b>Part Number</b>	<b>Temperature Range</b>	<b>Package</b>
Si9712DY	-40 to 85°C	SOIC-16
Si9712DY-T1		
Si9712DY-T1—E3		

<b>TRUTH TABLE<sup>b</sup></b>									
<b>S<sub>1</sub></b>	<b>S<sub>2</sub></b>	<b>S<sub>3</sub></b>	<b>S<sub>4</sub></b>	<b>Switch 1<sup>a</sup></b>	<b>Switch 2<sup>a</sup></b>	<b>Switch 3</b>	<b>Switch 4</b>	<b>Switch 5</b>	<b>Switch 6</b>
0	0	0	0	Off	Off	Off	Off	On	On
0	0	0	1	Off	Off	Off	On	On	Off
0	0	1	0	Off	Off	On	Off	On	Off
0	0	1	1	Off	Off	Off	Off	On	On
0	1	0	0	Off	Off	Off	Off	On	On
0	1	0	1	Off	On	Off	On	Off	Off
0	1	1	0	Off	On	On	Off	Off	Off
0	1	1	1	Off	Off	Off	Off	On	On
1	0	0	0	Off	Off	Off	Off	On	On
1	0	0	1	On	Off	Off	On	Off	Off
1	0	1	0	On	Off	On	Off	Off	Off
1	0	1	1	Off	Off	Off	Off	On	On
1	1	0	0	Off	Off	Off	Off	On	On
1	1	0	1	On	Off	Off	On	Off	Off
1	1	1	0	On	Off	On	Off	Off	Off
1	1	1	1	Off	Off	Off	Off	On	On

- Notes
- a. Turn on of switch 1 and 2 are internally delayed until after V<sub>CC</sub> is valid. See Figure 3.
  - b. Shaded lines are error conditions for PC Card applications, however, switches default to the states shown.

**TIMING DIAGRAM**

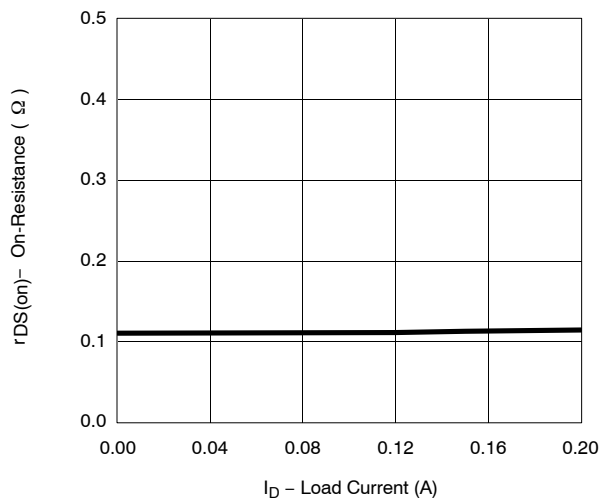


**FIGURE 4.** Break-Before-Make of SW<sub>1</sub> and SW<sub>2</sub>

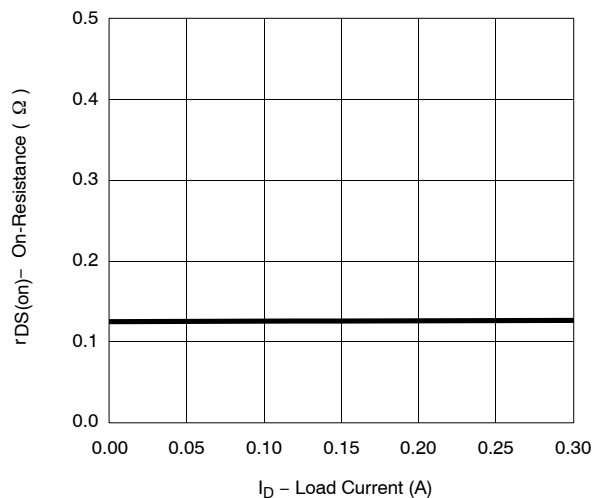


**TYPICAL CHARACTERISTICS (25°C UNLESS OTHERWISE NOTED)**

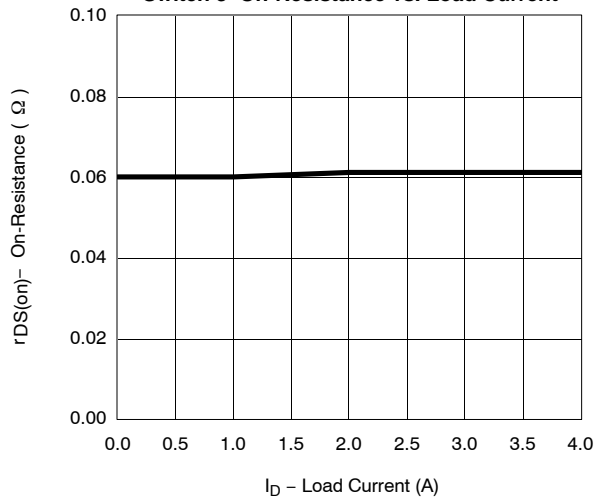
Switch 1—On-Resistance vs. Load Current



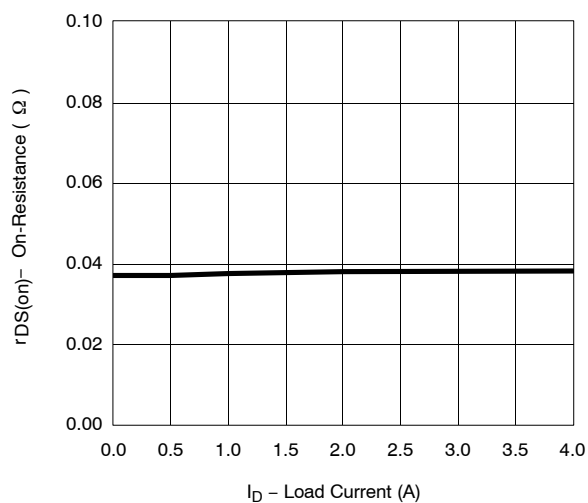
Switch 2—On-Resistance vs. Load Current



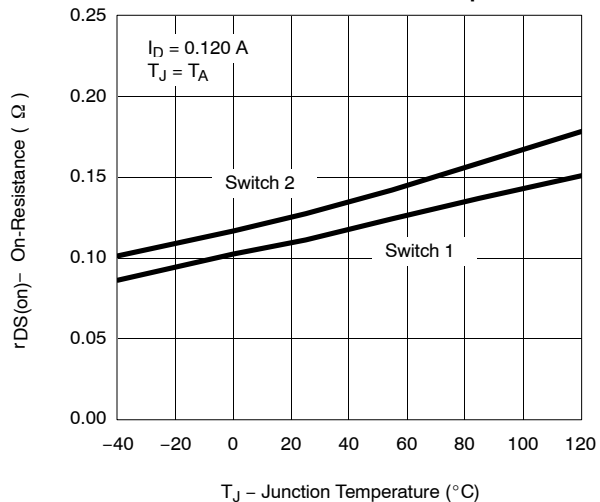
Switch 3—On-Resistance vs. Load Current



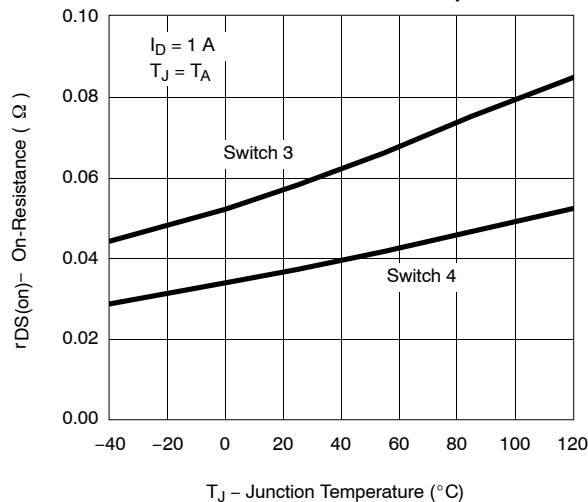
Switch 4—On-Resistance vs. Load Current



On-Resistance vs. Junction Temperature



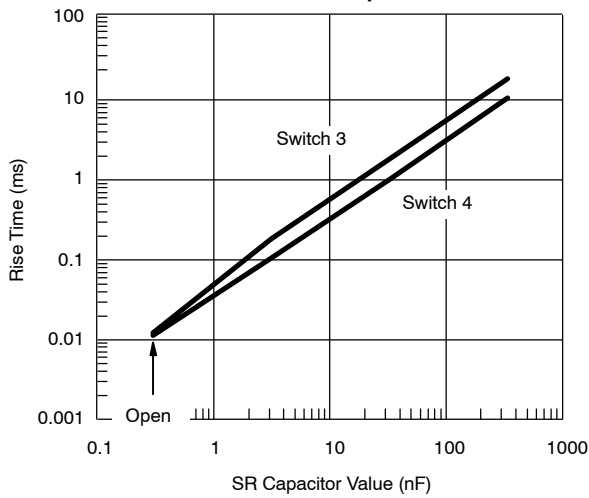
On-Resistance vs. Junction Temperature



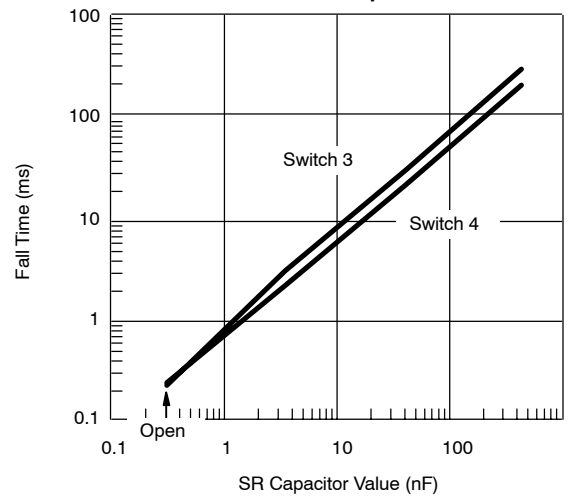


**TYPICAL CHARACTERISTICS (25°C UNLESS OTHERWISE NOTED)**

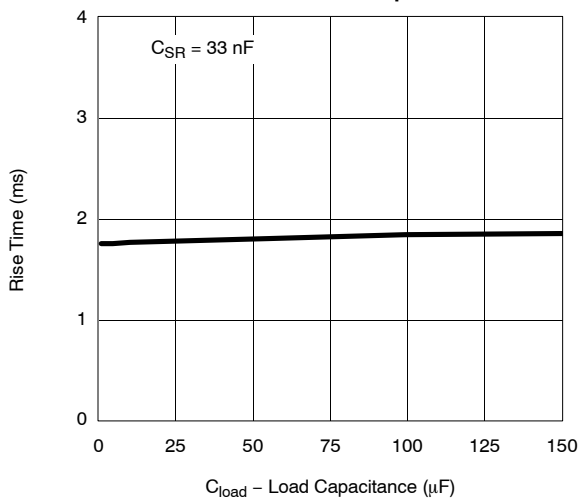
**Rise Time vs. SR Capacitor Value**



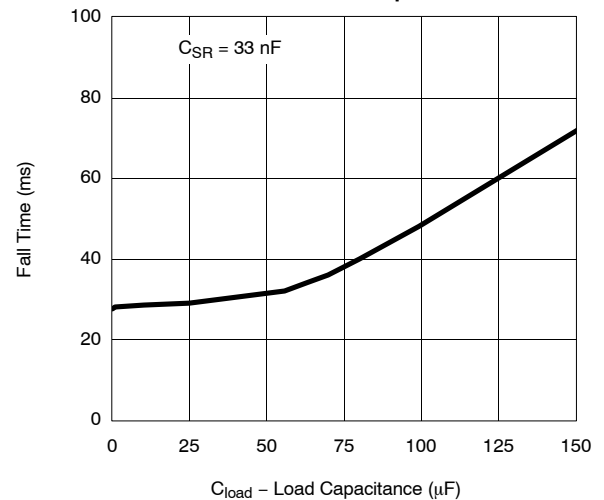
**Fall Time vs. SR Capacitor Value**



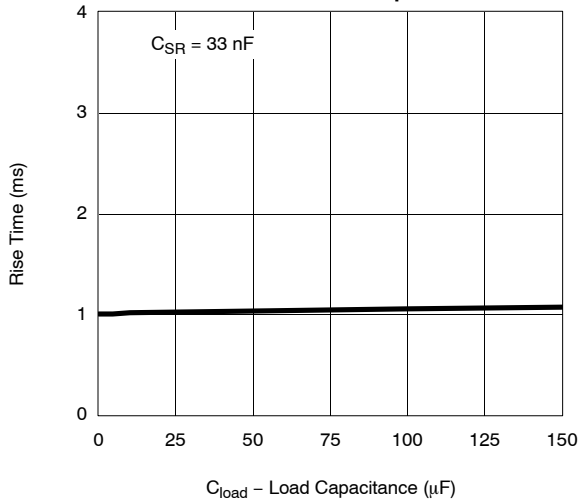
**Switch 3  
Rise Time vs. Load Capacitance**



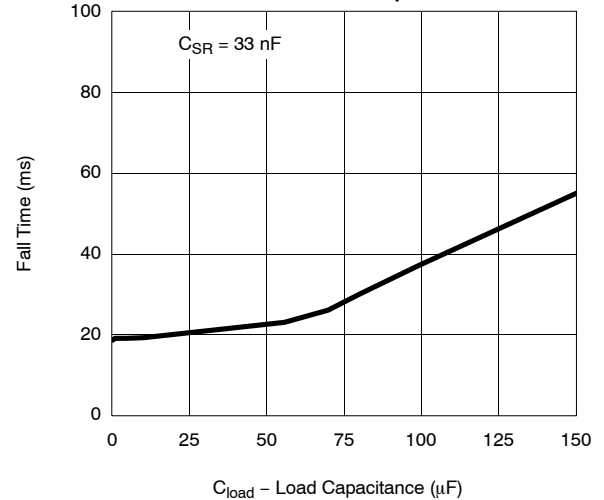
**Switch 3  
Fall Time vs. Load Capacitance**



**Switch 4  
Rise Time vs. Load Capacitance**



**Switch 4  
Fall Time vs. Load Capacitance**





## Disclaimer

All product specifications and data are subject to change without notice.

Vishay Intertechnology, Inc., its affiliates, agents, and employees, and all persons acting on its or their behalf (collectively, "Vishay"), disclaim any and all liability for any errors, inaccuracies or incompleteness contained herein or in any other disclosure relating to any product.

Vishay disclaims any and all liability arising out of the use or application of any product described herein or of any information provided herein to the maximum extent permitted by law. The product specifications do not expand or otherwise modify Vishay's terms and conditions of purchase, including but not limited to the warranty expressed therein, which apply to these products.

No license, express or implied, by estoppel or otherwise, to any intellectual property rights is granted by this document or by any conduct of Vishay.

The products shown herein are not designed for use in medical, life-saving, or life-sustaining applications unless otherwise expressly indicated. Customers using or selling Vishay products not expressly indicated for use in such applications do so entirely at their own risk and agree to fully indemnify Vishay for any damages arising or resulting from such use or sale. Please contact authorized Vishay personnel to obtain written terms and conditions regarding products designed for such applications.

Product names and markings noted herein may be trademarks of their respective owners.