

### DESCRIPTION

EV8003A-Q-00A Evaluation Board is designed to demonstrate the capability of MP8003A's function. MP8003A is an IEEE 802.3af/at power-over-Ethernet (PoE) compliant powered device (PD) interface controller. It has all the functions of IEEE 802.3af/at.

MP8003A sets 120mA inrush current limit and 840mA operation current limit, a PG signal sets to high to indicate output fully charged, and it pulls low when Vout drops in overload condition. MP8003A also provides a T2P signal when it is connected to a type 2 power sourcing equipment (PSE).

An AUX pin of MP8003A provides smoothly power switch from PSE to auxiliary wall adaptor. MP8003A also features built in thermal protection and wide input VULO hysteresis.

The MP8003A is available in a 10-pin QFN (3mm×3mm) package.

### ELECTRICAL SPECIFICATIONS

Parameter	Symbol	Value	Units
Input Voltage	$V_{IN}$	37-57	V
Adapter Voltage	$V_{ADAPTER}$	12	V
Output current	$I_{OUT}$	600	mA

### FEATURES

- Compatible with 802.3af/at Specifications
- 100V 0.48Ω Integrated Pass Switch
- 120mA Inrush Current Limit
- 840mA Operation Current Limit
- 2-Event Classification
- Auxiliary Adaptor ORing Power Supply
- Self-driving Power Good Inductor
- Open Drain Type 2 PSE Indicator
- Over Temperature Protection
- Available in QFN-10 (3mmx3mm) Package

### APPLICATIONS

- IEEE 802.3af/at-Compliant Devices
- Security Cameras
- VoIP Phones
- WLAN Access Points
- IoT Devices

All MPS parts are lead-free, halogen free, and adhere to the RoHS directive. For MPS green status, please visit MPS website under Quality Assurance.

"MPS" and "The Future of Analog IC Technology" are Registered Trademarks of Monolithic Power Systems, Inc.

### EV8003A-Q-00A EVALUATION BOARD

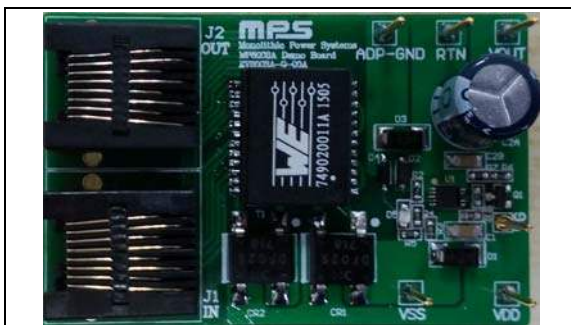

(L x W x H) (6.2cm x 4cm x 1.5cm)

Board Number	MPS IC Number
EV8003A-Q-00A	MP8003AGQ

### Start-Up by PSE

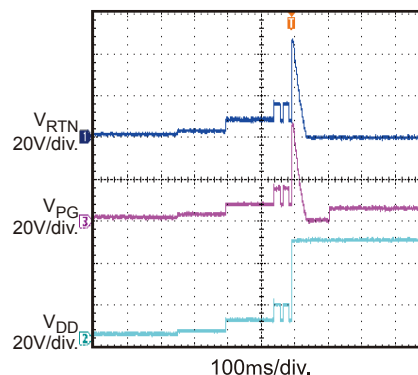

### EVALUATION BOARD SCHEMATIC

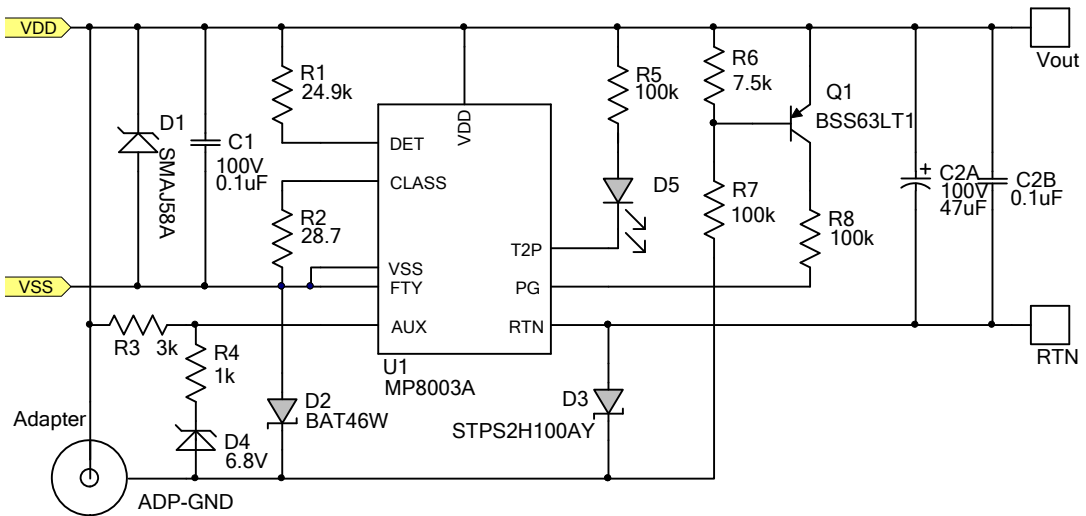
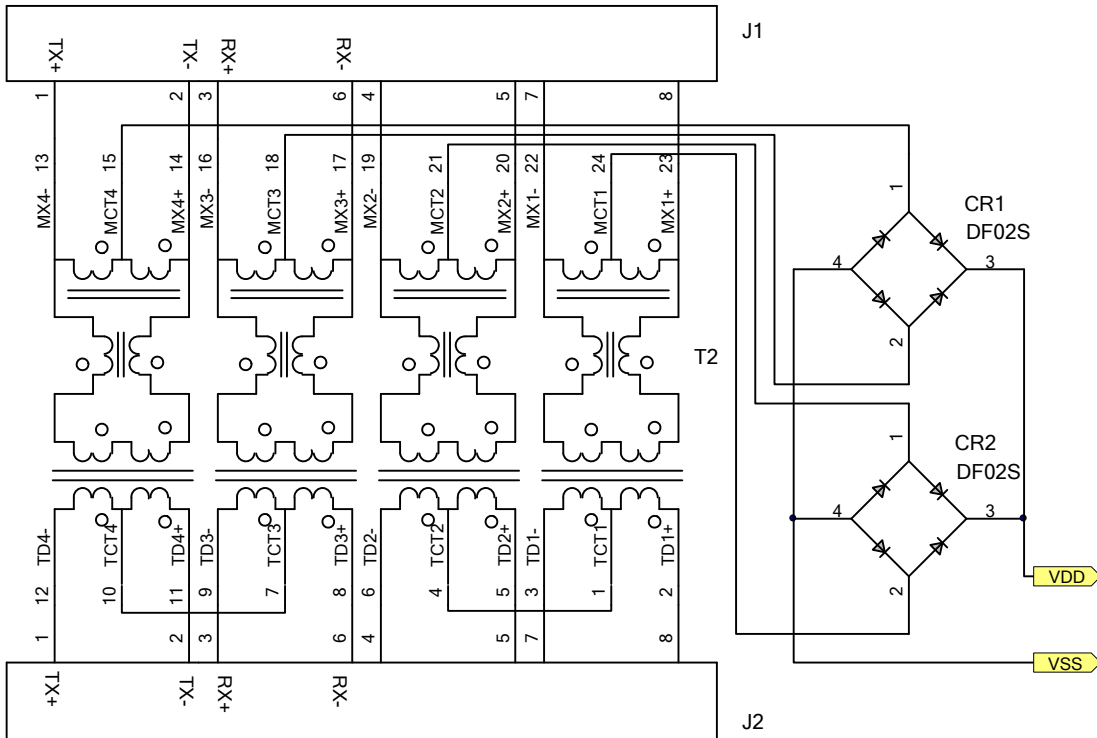

**EV8003A-Q-00A BILL OF MATERIALS**

Qty	Ref	Value	Description	Package	Manufacturer	Part Number
2	C1, C2B	0.1uF	Ceramic Cap. 100V, X7R	1206	Murata	GRM319R72A104KA0 1D
1	C2A	47µF	47uF 100V CD284 E- Cap. 10X12.5mm	DIP	JiangHai	47uF/100V
1	R1	24.9k	Film Res,1%	0603	ROYAL	RC0603FR-0724K9L
1	R2	28.7	Film Res,1%	0603	ROYAL	RC0603FR-0728R7L
1	R3	3k	Film Res,1%	0603	ROYAL	RC0603FR-073KL
1	R4	1k	Film Res,1%	0603	ROYAL	RC0603FR-071KL
3	R5,R7, R8	100k	Film Res,1%	0603	ROYAL	RC0603FR-07100KL
1	R6	7.5k	Film Res,1%	0603	ROYAL	RC0603FR-077K5L
1	D1	SMAJ58A	TVS	SMA	Littelfuse	SMAJ58A
1	D2	BAT46W	100V, DIODE	SOD-123	Diodes	BAT46W-7-F
1	D3	STPS2H10 0AY	2A,100V, SCHOTTKY	SMA	STMicroelectronics	STPS2H100AY
1	D4	6.8V	Diode Zener 6.8V	SOD-123	Diodes Inc	BZT52C6V8
1	T1	749020010 A	LAN-Transformer WE- LAN	SMD	Würth	749020010A
1	Q1	BSS63LT1	PNP, 100V, 100mA	SOT-23	Semiconductor	BSS63LT1G
2	CR1,C R2	DF02S	1.0A Surface Mount Glass Passivity Bridge Rectifier		Diodes Inc	DF02S
2	J1,J2	RJ45-8N4- B	RJ Jack / Signal Line EMI/RFI Filters 6 TRMN BRD/CBLE GRND 8 PIN BLOCK INDUCTOR	RJ45-TAB	Tyco Electronics	RJ45-8N4-B
1	U1	MP8003A	PD interface	QFN(3X3m m)	MPS	MP8003AGQ

## EVB TEST RESULTS

VDD=48V, R<sub>DET</sub> = 24.9kΩ, R<sub>CLASS</sub> =28.7Ω, I<sub>OUT</sub>=0.6A, T<sub>A</sub>=25°C, unless otherwise noted.

### Steady State

I<sub>OUT</sub> = 0A

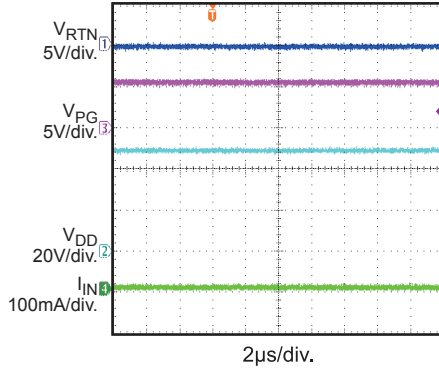

### Steady State

I<sub>OUT</sub> = 0.6A

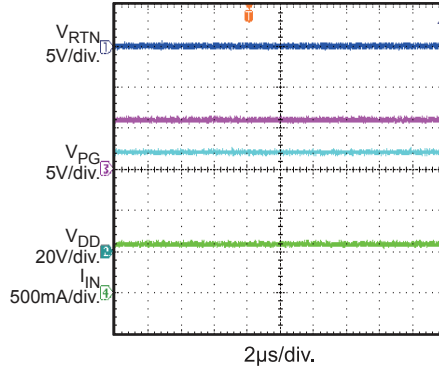

### V<sub>DD</sub> Start-Up

I<sub>OUT</sub> = 0A

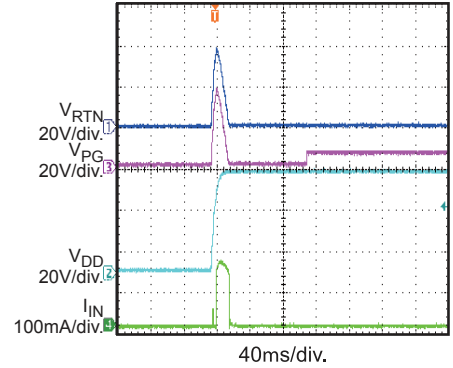

### V<sub>DD</sub> Shutdown

I<sub>OUT</sub> = 0A

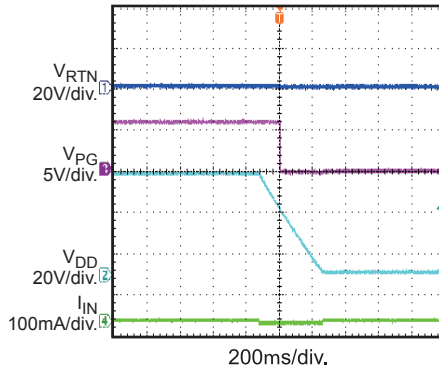

### V<sub>DD</sub> Shutdown

I<sub>OUT</sub> = 0.6A

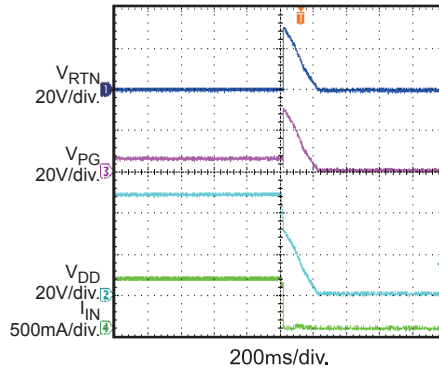

### Start-Up by PSE

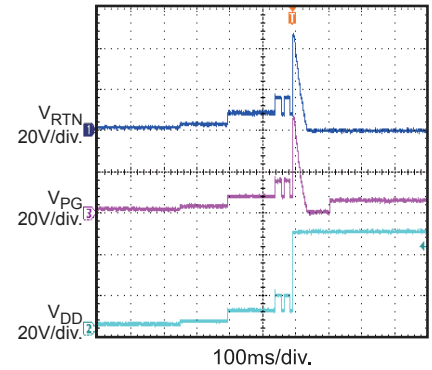

### OCP Entry

I<sub>OUT</sub> = 0A to 1A

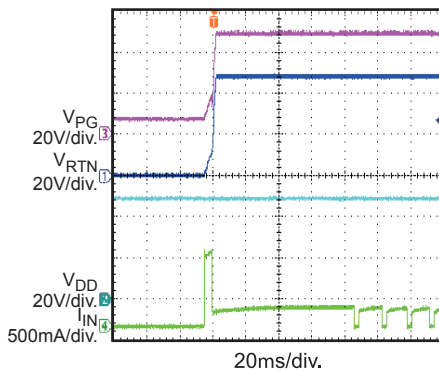

### OCP Recovery

I<sub>OUT</sub> = 1A to 0A

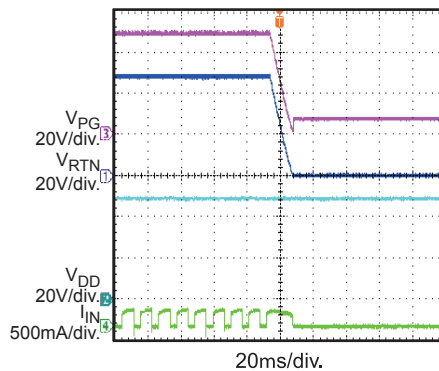

### Load Transient

I<sub>OUT</sub> = 0A to 0.6A

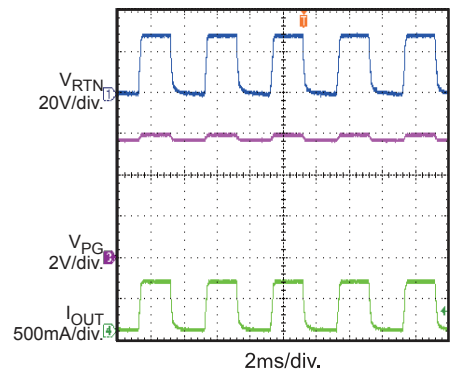

## PRINTED CIRCUIT BOARD LAYOUT

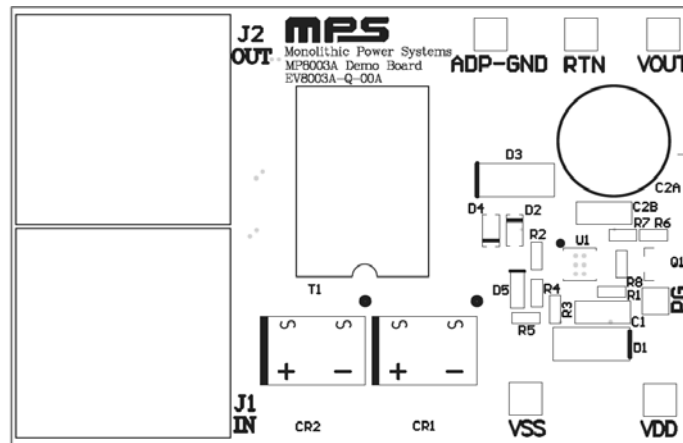

Figure 1: Top Silk Layer

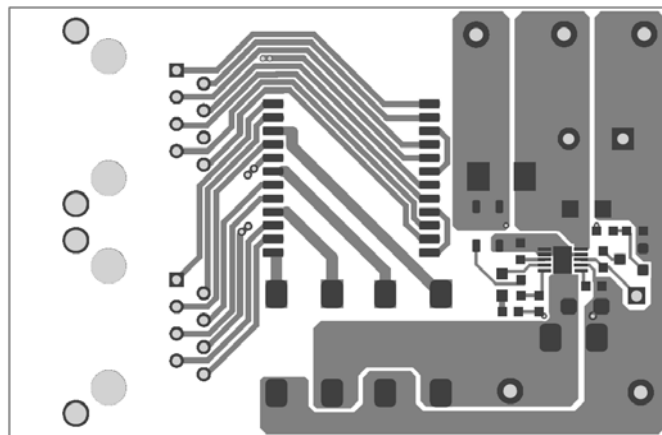

Figure 2: Top Layer

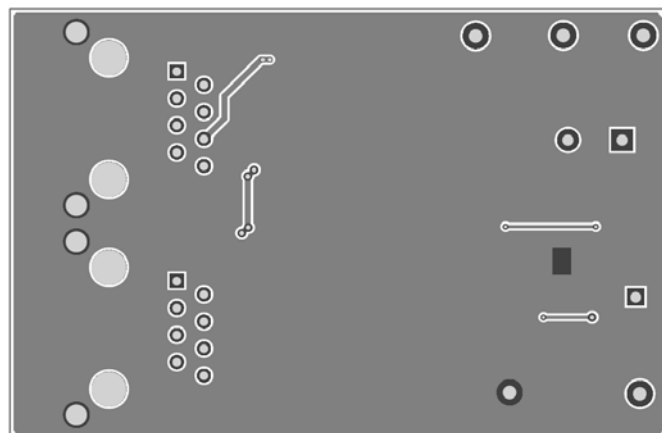

Figure 3: Bottom Layer

## QUICK START GUIDE

The board layout accommodates most commonly used components. There are two methods to start EV8003A-Q-00A.

Method 1:

1. Connect Load to:
  - a. Positive (+): VOUT
  - b. Negative (–): RTN
2. Plug the cable coming from the PSE into the Ethernet Jack J1. The board will automatically startup.

Method 2:

1. Preset Power Supply to  $40V \leq V_{IN} \leq 57V$ . (It can work in  $33V \leq V_{IN} \leq 57V$  after power up.)
2. Turn Power Supply off.
3. Connect Power Supply terminals to:
  - a. Positive (+): VDD
  - b. Negative (–): VSS
4. Connect Load to:
  - a. Positive (+): VOUT
  - b. Negative (–): RTN
5. Turn Power Supply on after making connections.
7. To use adapter supply function, connect one 12V adapter's positive terminal to VDD and negative terminal to ADP-GND, then turn on the adapter, the board will prior use adapter to supply the load. If the adaptor voltage is too high, some additional circuit is needed to clamp the AUX pin voltage.

**NOTICE:** The information in this document is subject to change without notice. Please contact MPS for current specifications. Users should warrant and guarantee that third party Intellectual Property rights are not infringed upon when integrating MPS products into any application. MPS will not assume any legal responsibility for any said applications.