

1

2

3

4

5

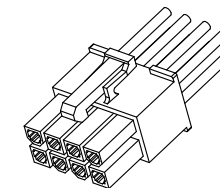
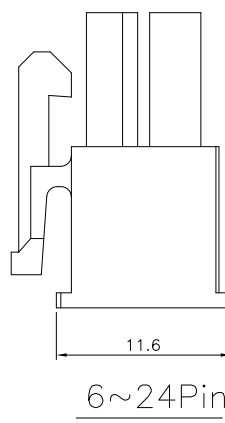
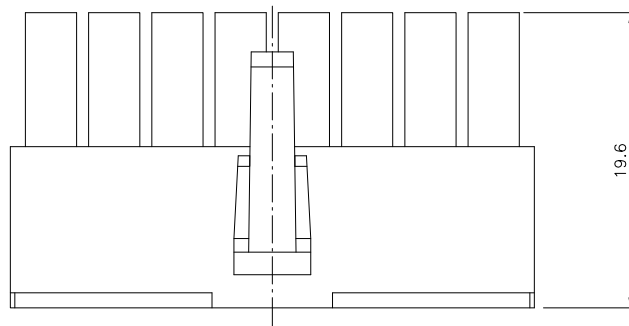
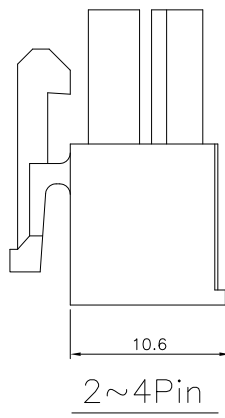
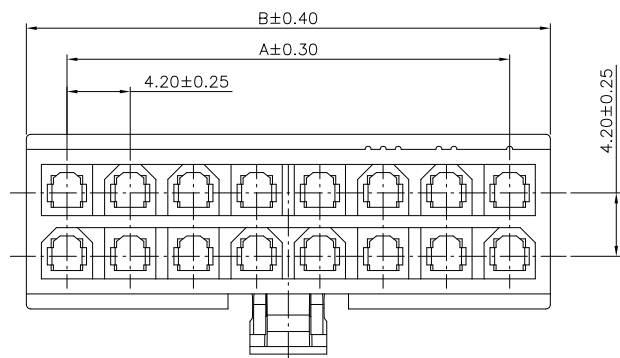

Specifications:

Current Rating:9.0A AC/DC

Voltage Rating:600V AC/DC

Contact Resistance:10m Ohm. Max.

Insulation Resistance:1,000M Ohm. Min.

Withstanding Voltage:1500V AC/Minute

Operating Temperature Range:-40°C ~ +105°C

Material And Finish:

Insulator:Nylon 66 (UL94V-0)

Color:White

Dimension:

Circuits	DIM.A	DIM.B	Circuits	DIM.A	DIM.B
2	/	5.40	14	25.20	30.60
4	4.20	9.60	16	29.40	34.80
6	8.40	13.80	18	33.60	39.00
8	12.60	18.00	20	37.80	43.20
10	16.80	22.20	22	42.00	47.40
12	21.00	26.40	24	46.20	51.60

RoHS Compliant

DRAWN:

GENERAL TOLERANCE:

.X=±0.40

.XX=±0.30

CnC Tech

Industrial Cable and Connector Technology

CHECKED:

UNIT: MM

DESCRIPTION:

SIZE

SCALE:1:1

CONN RECEPT DUAL 94V-0

APPROVAL:

SHEET: 1 / 3

PART NO:

A4

REV

DAIE

FILE

BY

PROJECTION:

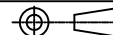

4281-2-XX-D

1

2

3

4

5

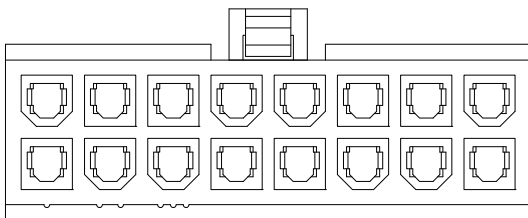

Note:
1.Dimension:
Carton Size:40*28*28(cm)

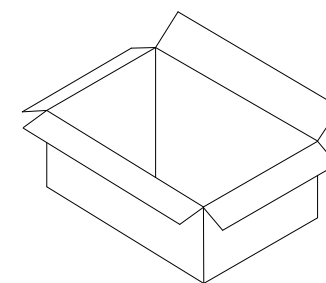
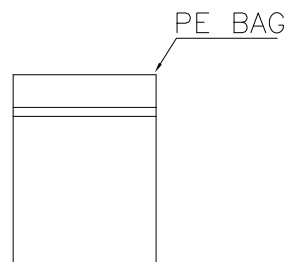
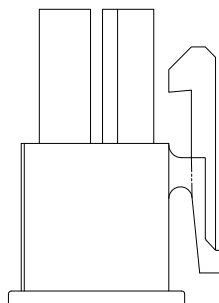
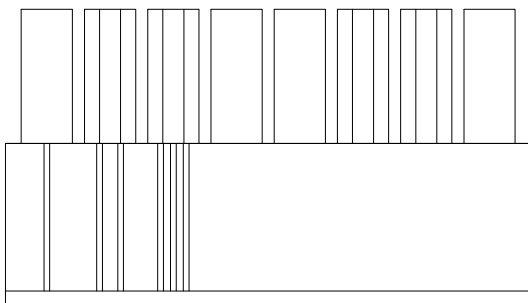

Pin.	Pcs/Bag	Pcs/Carton	Pin.	Pcs/Bag	Pcs/Carton
2	1000	14000	14	100	2000
4	200	7600	16	100	1600
6	200	4800	18	100	1600
8	200	4000	20	100	1200
10	100	3000	22	100	1200
12	100	2600	24	100	1200

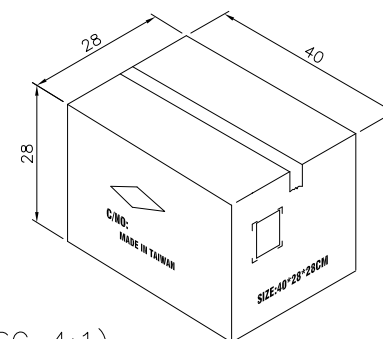
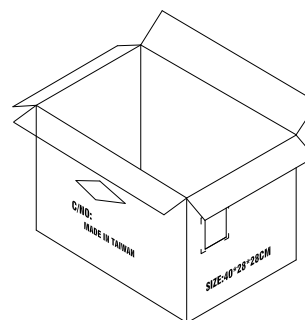

Carton (SC 4:1)

RoHS Compliant

				DRAWN:	GENERAL TOLERANCE: .X=±0.20 .XX=±0.15	CnC Tech Industrial Cable and Connector Technology	SIZE A4
				CHECKED:	UNIT: MM SCALE:1:1		
				APPROVAL:	SHEET: 3 / 3	PART NO: 4281-2-XX-D	
REV	DATE	FILE	BY		PROJECTION:		