



SANYO Semiconductors

DATA SHEET

LV8743V — Bi-CMOS LSI PWM Constant-Current Control Stepping Motor Driver and Switching Regulator Controller

Overview

The LV8743V is a PWM constant-current control stepping motor driver and switching regulator controller IC.

Features

- Provides a single PWM constant-current control stepping motor driver circuit
- Two switching regulator controller circuits
- Can control stepping motors with up to W1-2 phase commutation
- Built-in high-precision reference voltage circuit
- Timer/latch type short circuit protection circuit
- Built-in high and low side regenerative diodes
- Thermal shutdown circuit

Specifications

Absolute Maximum Ratings at $T_a = 25^\circ\text{C}$

Parameter	Symbol	Conditions	Ratings	Unit
Maximum supply voltage	V_M max		40	V
	V_{CC} max		6	V
Output voltage	V_O max		40	V
Driver output peak current	MDI_O peak	$t_w \leq 10\text{ms}$, duty 20%	800	mA
Driver output continuous current	MDI_O max		500	mA
Regulator output current	SWI_O max		120	mA
Allowable power dissipation	P_d max1	Independent IC	0.5	W
	P_d max2	Mounted on a circuit board.*	2.8	W
Operating temperature	T_{opr}		-20 to +85	$^\circ\text{C}$
Storage temperature	T_{stg}		-55 to +150	$^\circ\text{C}$

* Specified circuit board : $90 \times 90 \times 1.7\text{mm}^3$: 2-layer glass epoxy printed circuit board

■ Any and all SANYO Semiconductor Co.,Ltd. products described or contained herein are, with regard to "standard application", intended for the use as general electronics equipment (home appliances, AV equipment, communication device, office equipment, industrial equipment etc.). The products mentioned herein shall not be intended for use for any "special application" (medical equipment whose purpose is to sustain life, aerospace instrument, nuclear control device, burning appliances, transportation machine, traffic signal system, safety equipment etc.) that shall require extremely high level of reliability and can directly threaten human lives in case of failure or malfunction of the product or may cause harm to human bodies, nor shall they grant any guarantee thereof. If you should intend to use our products for applications outside the standard applications of our customer who is considering such use and/or outside the scope of our intended standard applications, please consult with us prior to the intended use. If there is no consultation or inquiry before the intended use, our customer shall be solely responsible for the use.

■ Specifications of any and all SANYO Semiconductor Co.,Ltd. products described or contained herein stipulate the performance, characteristics, and functions of the described products in the independent state, and are not guarantees of the performance, characteristics, and functions of the described products as mounted in the customer's products or equipment. To verify symptoms and states that cannot be evaluated in an independent device, the customer should always evaluate and test devices mounted in the customer's products or equipment.

SANYO Semiconductor Co., Ltd.

TOKYO OFFICE Tokyo Bldg., 1-10, 1 Chome, Ueno, Taito-ku, TOKYO, 110-8534 JAPAN

LV8743V

Recommended Operating Ratings at $T_a = 25^\circ\text{C}$

Parameter	Symbol	Conditions	Ratings	Unit
Supply voltage range	V_M		10 to 35	V
	V_{CC}		4.5 to 5.5	V
Logic input voltage	V_{IN}		0 to $V_{CC}+0.3$	V
VREF1 input voltage	VREF1		0 to 3	V
Regulator output voltage	V_O		10 to V_M	V
Regulator output current	I_O		0 to 100	mA
Error amplifier input voltage	VOA		0 to 3	V
Timing capacitor	CT		100 to 15000	pF
Timing resistor	RT		5 to 50	k Ω
Triangle wave frequency	FOSC		10 to 800	kHz

Electrical Characteristics at $T_a = 25^\circ\text{C}$, $V_M = 24\text{V}$, $V_{CC} = 5\text{V}$, VREF1 = 1.5V

Parameter	Symbol	Conditions	Ratings			Unit
			min	typ	max	
Overall Characteristics						
V_M current consumption	I_M	PS = High, no load		2.5	3.5	mA
V_{CC} current consumption	I_{CC}	PS = High, no load		3.5	4.5	mA
V_{CC} low-voltage cutoff voltage	$V_{thV_{CC}}$		3.2	3.5	3.8	V
Low-voltage cutoff hysteresis	V_{thHIS}		60	110	160	mV
Thermal shutdown temperature	TSD	Design guarantee		180		$^\circ\text{C}$
Thermal shutdown hysteresis	ΔTSD	Design guarantee		40		$^\circ\text{C}$
Motor Drivers [Charge pump block]						
Step-up voltage	VGH	$V_M = 24\text{V}$, $V_{CC} = 5\text{V}$	28.3	28.8	29.3	V
Rise time	tONG	VGH = 10 μF		50	100	ms
Oscillator frequency	Fchop		90	120	150	kHz
[Output block]						
Output on resistance	Ron1	$I_O = 300\text{mA}$, sink side		1.1	1.4	Ω
	Ron2	$I_O = -300\text{mA}$, source side		1.5	1.8	Ω
Output leakage current	I_{Oleak}	$V_O = 35\text{V}$			50	μA
Diode forward voltage	VD	$I_D = -300\text{mA}$		1.0	1.3	V
[Logic input block]						
Logic pin input current	I_{INL}	$V_{IN} = 0.8\text{V}$	3	8	15	μA
	I_{INH}	$V_{IN} = 5\text{V}$	30	50	70	μA
Logic high-level input voltage	V_{INH}		2.0			V
Logic low-level input voltage	V_{INL}				0.8	V
[Current control block]						
VREF input current	IREF1	VREF1 = 1.5V	-0.5			μA
CR pin current	ICR	CR = 1.0V	-1.6	-1.25	-0.9	mA
MD pin voltage	VMD	MD = open	3.21	3.38	3.55	V
Current setting comparator threshold voltage	VHH	VREF1 = 1.5V, $I_O = \text{H}$, $I_1 = \text{H}$	0.291	0.300	0.309	V
	VLH	VREF1 = 1.5V, $I_O = \text{L}$, $I_1 = \text{H}$	0.191	0.200	0.209	V
	VHL	VREF1 = 1.5V, $I_O = \text{H}$, $I_1 = \text{L}$	0.093	0.100	0.107	V
Switching Regulator Controller [Reference voltage block]						
Output voltage	VREGS	$I_{regs} = -1\text{mA}$	2.475	2.500	2.525	V
Input stability	VDLI	$V_M = 10$ to 35V			10	mV
Load stability	VDLO	$I_{regs} = 0$ to -3mA			10	mV
[Triangle wave oscillator block]						
Oscillator frequency	FOSC	RT = 10k Ω , CT = 200pF	360	400	440	kHz
Frequency stability	FDV	$V_M = 10$ to 35V		1	5	%
Current setting pin voltage	VRT	RT = 10k Ω	0.89	0.96	1.03	V

Continued on next page.

LV8743V

Continued from preceding page.

Parameter	Symbol	Conditions	Ratings			Unit
			min	typ	max	
[Protection circuit block]						
Comparator threshold voltage	VthFB	FB3, FB4	1.38	1.53	1.68	V
Standby voltage	VstSCP	ISCP = 40 μ A			100	mV
Source current	ISCP	VSCP = 0V	1.5	2.4	3.3	μ A
Threshold voltage	VthSCP		1.55	1.7	1.85	V
Latch voltage	VltSCP	ISCP = 40 μ A			100	mV
[Soft start circuit block]						
Source current	ISOFT	VSOFT = 0V	1.15	1.45	1.75	μ A
Latch voltage	VltSOFT	ISOFT = 40 μ A			100	mV
[Low input voltage malfunction prevention circuit]						
Threshold voltage	VUT		8.4	8.8	9.2	V
Hysteresis voltage	VHIS		240	340	440	mV
[Error amplifier block]						
Input offset voltage	Vio				6	mV
Input offset current	Iio				30	nA
Input bias current	Iib				100	nA
Open-loop gain	AV			85		dB
Common-mode input voltage range	VCM	VM = 10 to 35V			3.0	V
Common-mode rejection ratio	CMRR			80		dB
Maximum output voltage	VOH		4.5	5.0		V
Minimum output voltage	VOL			0.2	0.5	V
Output sink current	I _{si}	FB = 2.5V	300	600	1000	μ A
Output source current	I _{so}	FB = 2.5V	45	75	105	μ A
[PWM comparator block]						
Input threshold voltage (Fosc = 10kHz)	VT100	Duty cycle = 100%	0.90	0.96	1.02	V
	VT0	Duty cycle = 0%	0.45	0.48	0.51	V
Input bias current	IBDT	DT = 0.4V			1	μ A
Maximum duty cycle	Don	With the VREGS voltage divided by 17k Ω and 8k Ω resistors	57	67	77	%
[Output block]						
Output on resistance	Ron	I _O = 75mA		7	10	Ω
Leakage current	ILEAK	V _O = 35V			5	μ A

Package Dimensions

unit : mm (typ)

3333

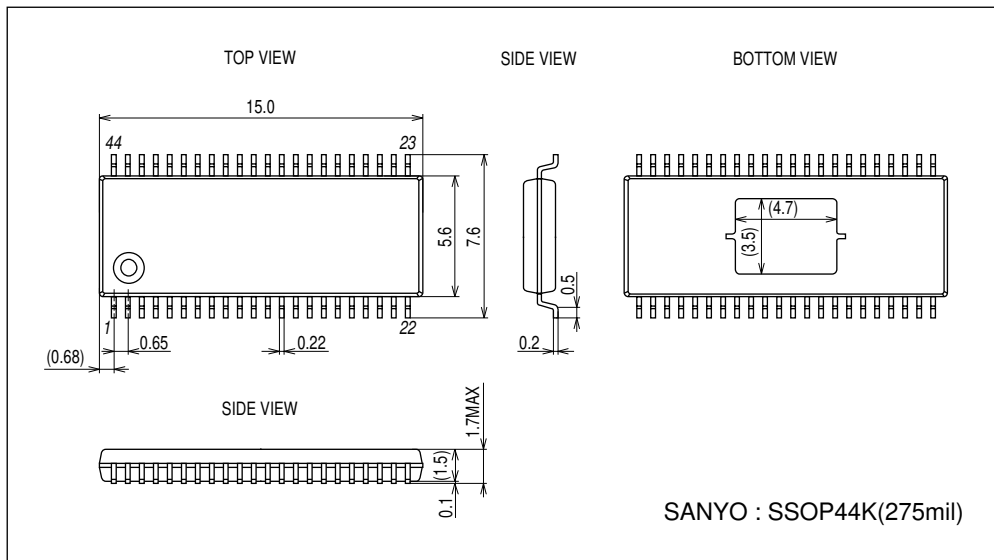

LV8743V

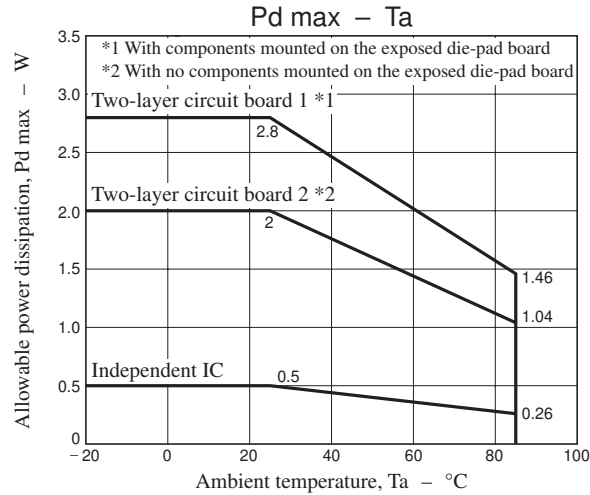

Substrate Specifications (Substrate recommended for operation of LV8743V)

Size : 90mm × 90mm × 1.7mm (2-layer substrate [2S0P])
Material : Glass epoxy
Copper wiring density : L1 = 80% / L2 = 90%

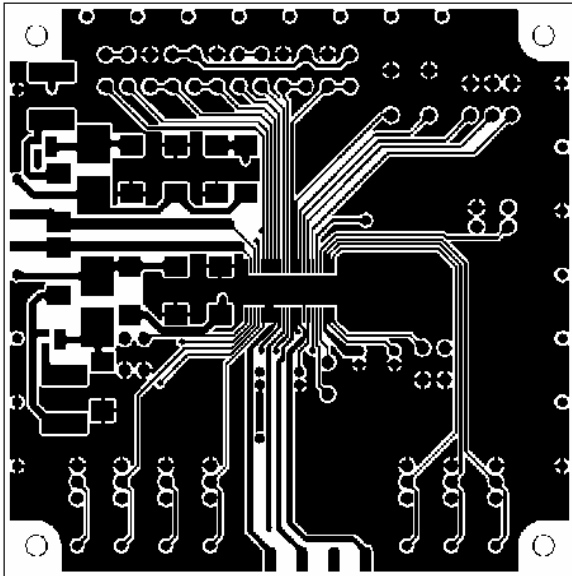

L1 : Copper wiring pattern diagram

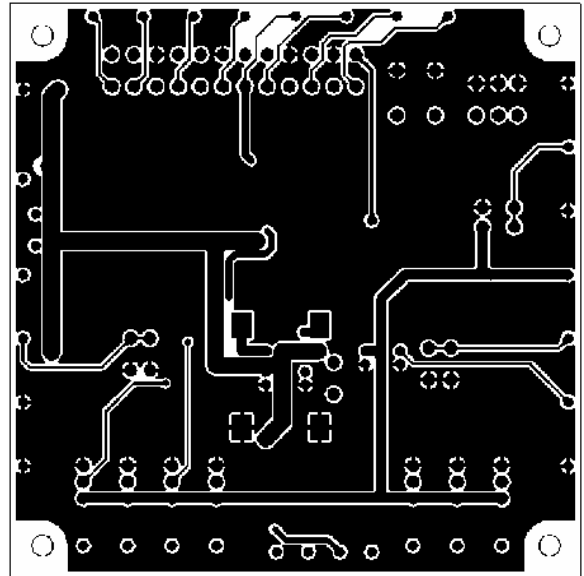

L2 : Copper wiring pattern diagram

Cautions

- 1) The data for the case with the Exposed Die-Pad substrate mounted shows the values when 95% or more of the Exposed Die-Pad is wet.
- 2) For the set design, employ the derating design with sufficient margin.
Stresses to be derated include the voltage, current, junction temperature, power loss, and mechanical stresses such as vibration, impact, and tension.
Accordingly, the design must ensure these stresses to be as low or small as possible.
The guideline for ordinary derating is shown below :
 - (1)Maximum value 80% or less for the voltage rating
 - (2)Maximum value 80% or less for the current rating
 - (3)Maximum value 80% or less for the temperature rating
- 3) After the set design, be sure to verify the design with the actual product.
Confirm the solder joint state and verify also the reliability of solder joint for the Exposed Die-Pad, etc.
Any void or deterioration, if observed in the solder joint of these parts, causes deteriorated thermal conduction, possibly resulting in thermal destruction of IC.

LV8743V

Pin Assignment

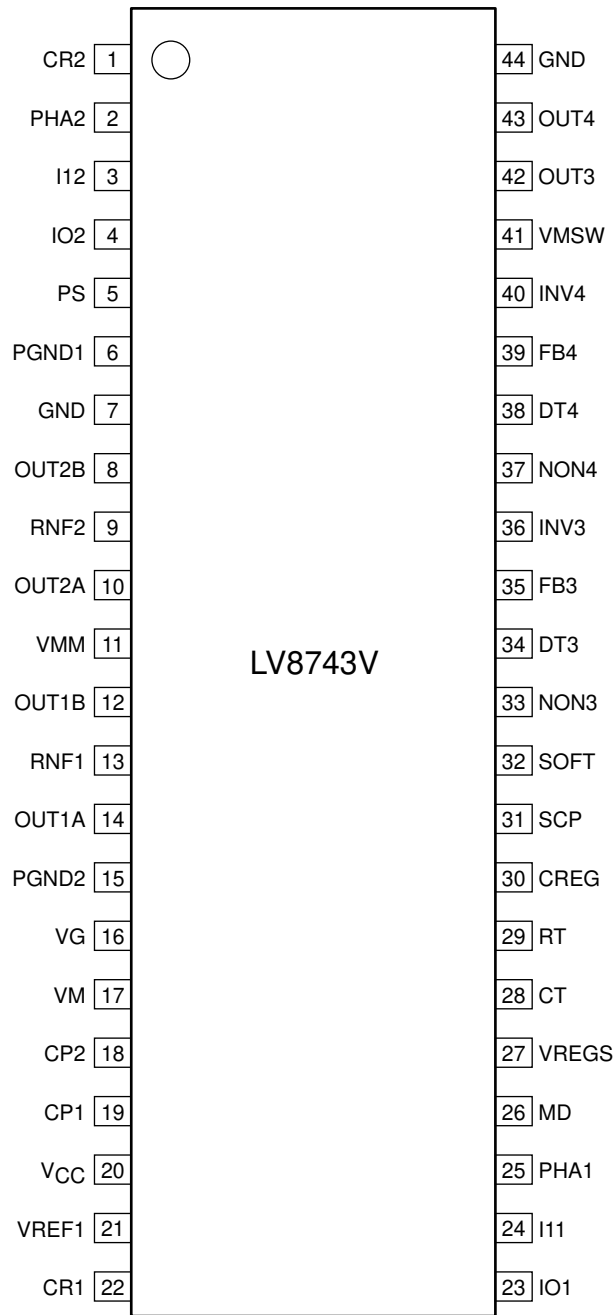

Top view

PCA01177

Block Diagram

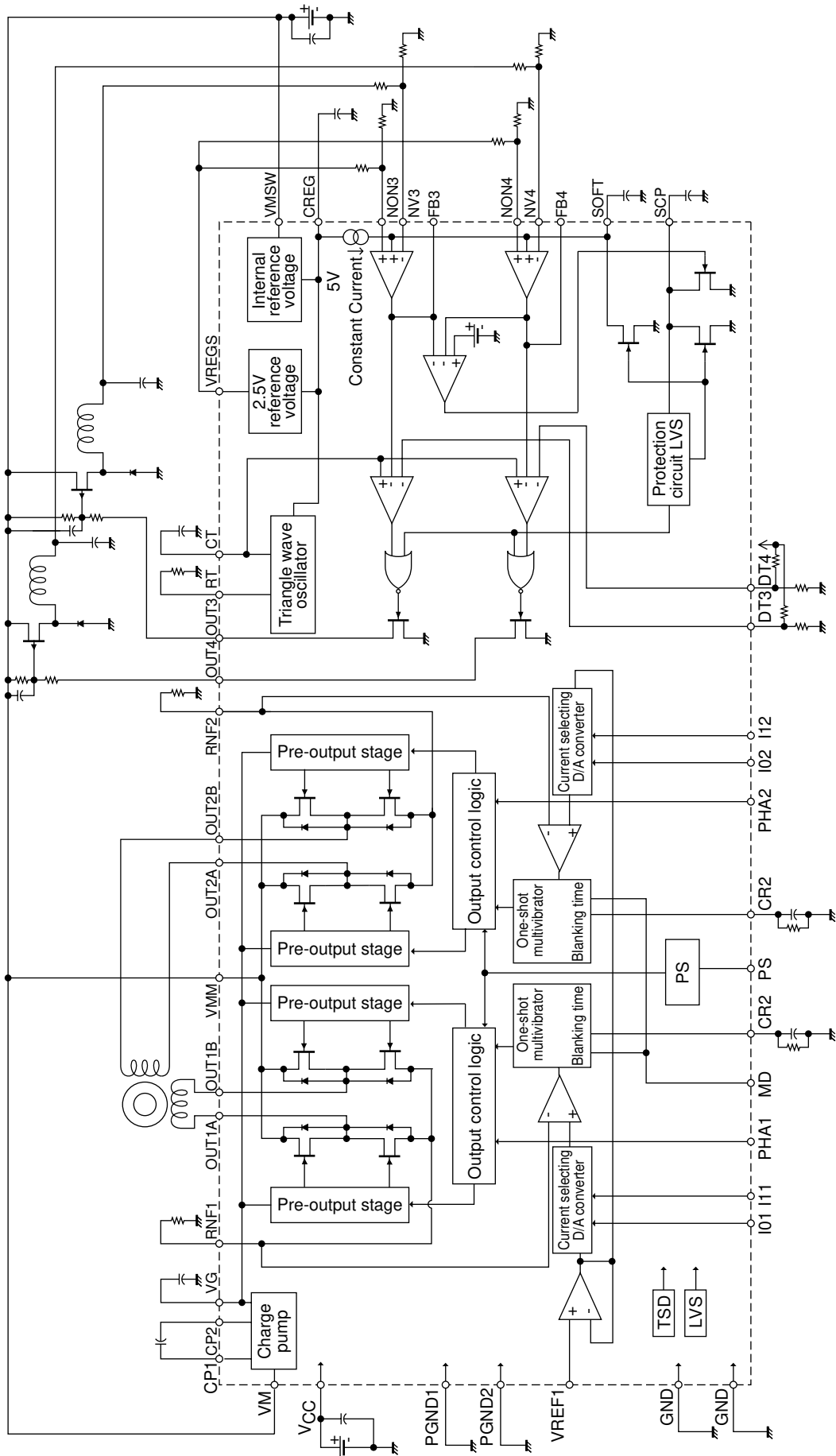

LV8743V

Pin Functions

Pin No.	Pin	Description
11	VMM	Driver output system power supply
14	OUT1A	Driver channel 1 OUTA output pin
12	OUT1B	Driver channel 1 OUTB output pin
13	RNF1	Driver channel 1 current sensing resistor connection
10	OUT2A	Driver channel 2 OUTA output pin
8	OUT2B	Driver channel 2 OUTB output pin
9	RNF2	Driver channel 2 current sensing resistor connection
6	PGND1	Driver output system ground
21	VREF1	Driver output current setting reference voltage input
23	I01	Driver channel 1 output current setting input
24	I11	
25	PHA1	Driver channel 1 output phase switching input
22	CR1	Driver channel 1 off time setting RC circuit connection
4	I02	Driver channel 2 output current setting input
3	I12	
2	PHA2	Driver channel 2 output phase switching input
1	CR2	Driver channel 2 off time setting RC circuit connection
26	MD	Driver system mixed decay setting
5	PS	Driver system enable input
20	V _{CC}	Control system power supply
44	GND	Ground
41	VMSW	Switching regulator control system power supply
27	VREGS	Regulator system reference voltage output
33	NON3	Regulator system error amplifier 3 noninverting input
36	INV3	Regulator system error amplifier 3 inverting input
35	FB3	Regulator system error amplifier 3 output
34	DT3	Regulator system output 3 maximum duty setting
42	OUT3	Output 3
37	NON4	Regulator system error amplifier 4 noninverting input
40	INV4	Regulator system error amplifier 4 inverting input
39	FB4	Regulator system error amplifier 4 output
38	DT4	Regulator system output 4 maximum duty setting
43	OUT4	Output 4
28	CT	Regulator system external timing capacitor connection
29	RT	Regulator system external timing resistor connection
32	SOFT	Soft startup setting
31	SCP	Regulator system timer/latch setting
17	VM	Power supply
15	PGND2	Power system ground
16	VG	Charge pump capacitor connection
19	CP1	Charge pump capacitor connection
18	CP2	Charge pump capacitor connection
30	CREG	Internal power supply stabilization capacitor connection
7	GND	Ground

LV8743V

Equivalent Circuits

Pin No.	Pin	Equivalent Circuit
23 24 25 5 4 3 2	I01 I11 PHA1 PS I02 I12 PHA2	
8 9 10 11 12 13 14	OUT2B RNF2 OUT2A VMM OUT1B RNF1 OUT1A	
19 16 17 18	CP1 VG VM CP2	

Continued on next page.

LV8743V

Continued from preceding page.

Pin No.	Pin	Equivalent Circuit
21	VREF1	
22 1	CR1 CR2	
26	MD	

Continued on next page.

LV8743V

Continued from preceding page.

Pin No.	Pin	Equivalent Circuit
41 30	VMSW CREG	
27	VREGS	
33 36 35 37 40 39	NON3 INV3 FB3 NON4 INV4 FB4	

Continued on next page.

LV8743V

Continued from preceding page.

Pin No.	Pin	Equivalent Circuit
34 38	DT3 DT4	
29 28	RT CT	
42 43	OUT3 OUT4	

Continued on next page.

LV8743V

Continued from preceding page.

Pin No.	Pin	Equivalent Circuit
32	SOFT	
31	SCP	

Stepping Motor Driver

(1) STM output control logic

Parallel input		Output		Current direction
PS	PHA	OUTA	OUTB	
Low	*	Off	Off	Standby
High	Low	Low	High	OUTB→OUTA
High	High	High	Low	OUTA→OUTB

(2) STM constant-current settings

I0	I1	Output current
High	High	$(VREF1/5) / RNF = I_O (100\%)$
Low	High	$((VREF1/5) / RNF) \times 2/3 = I_O (100\%) \times 2/3$
High	Low	$((VREF1/5) / RNF) \times 1/3 = I_O (100\%) \times 1/3$
Low	Low	0

The STM driver constant-current control settings consist of the VREF1 voltage setting, the I0 and I1 current settings, and the resistor (RNF) connected between RNF and ground. The current is set according to the following equation.

$$I_{const} [A] = ((VREF1 [V] / 5) / RNF [\Omega]) \times \text{attenuation ratio}$$

Here VREF1 = 1.5V, I0 = I1 = high, and RNF = 1Ω. Iconst can be determined from the following equation.

$$I_{const} = 1.5V/5/1\Omega \times 1 = 0.3A$$

(3) Procedure for setting the CR pin constants (the off period and noise canceller time settings)

The following are set by connecting a capacitor and resistor to the CR pin.

- (a) The switching off time (Toff) in constant-current control mode
- (b) The noise cancellation time (Tn) used to prevent malfunctions due to spike noise when switching from decay to charge mode.

Use the following equations to determine the values for the capacitor and resistor.

- (a) Switching off time (Toff)

$$T_{off} \approx -C \times R \times \ln (1.5/4.8) \text{ [sec]}$$

- (b) Noise cancellation time (Tn)

$$T_n \approx C \times R \times \ln \{(1.5 - RI)/(4.0 - RI)\} \text{ [sec]}$$

I : The CR pin charge current (1.25mA, typical)

LV8743V

(4) Constant-current control timing chart

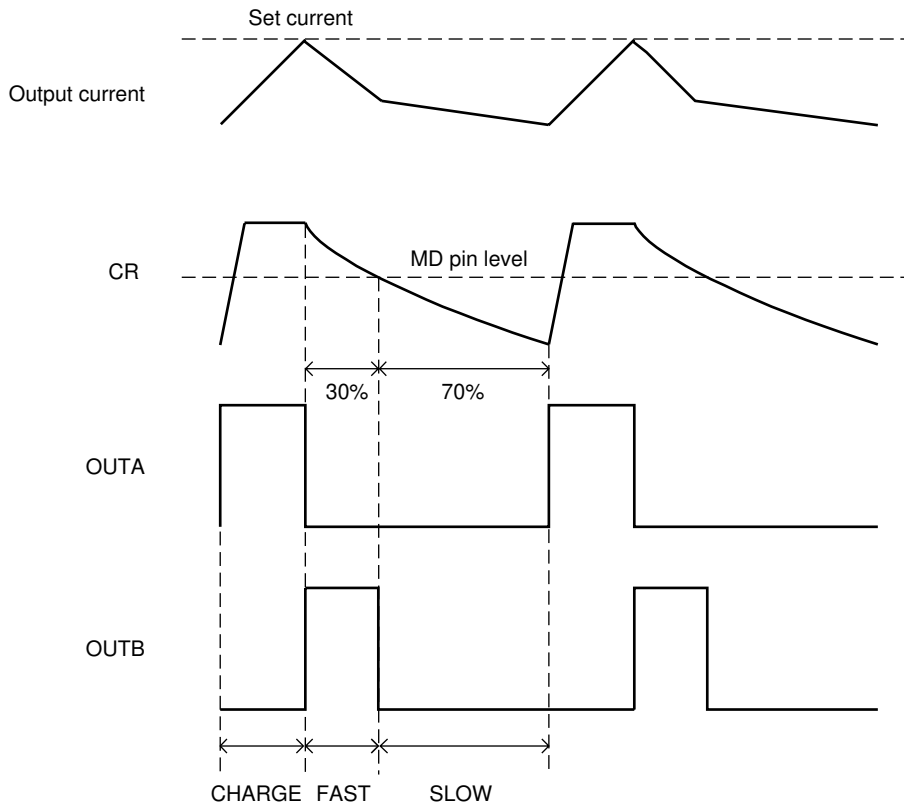

When the MD pin is in the open state, the LV8743V's stepping motor constant-current control attenuates the current in fast decay mode for 30% of the off time determined by the CR pin RC circuit, and in slow decay mode for 70% of that time.

This mixed decay ratio can be adjusted to an appropriate value by applying an appropriate voltage to the MD pin from an external circuit. If the MD pin is shorted to VCC, operation is locked in slow decay mode for this period, and if it is shorted to ground, operation is locked in fast decay mode.

LV8743V

(5) Output current vector locus (one step is normalized to 90 degrees)

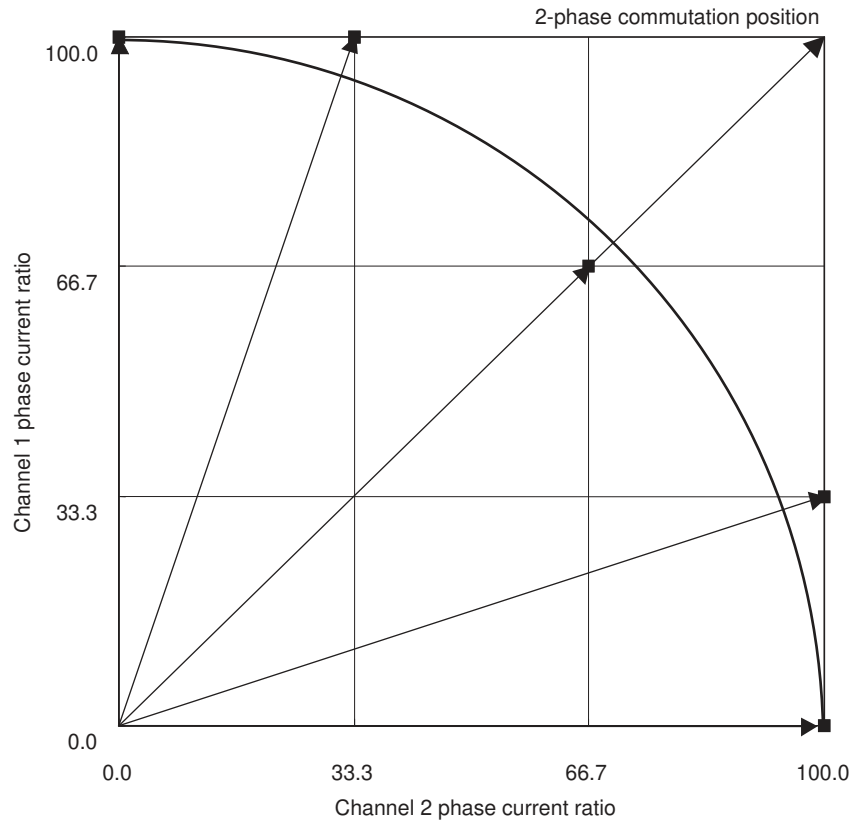

(6) Current waveforms in the various commutation modes
 2-phase commutation (Channels 1 and 2, CW mode)

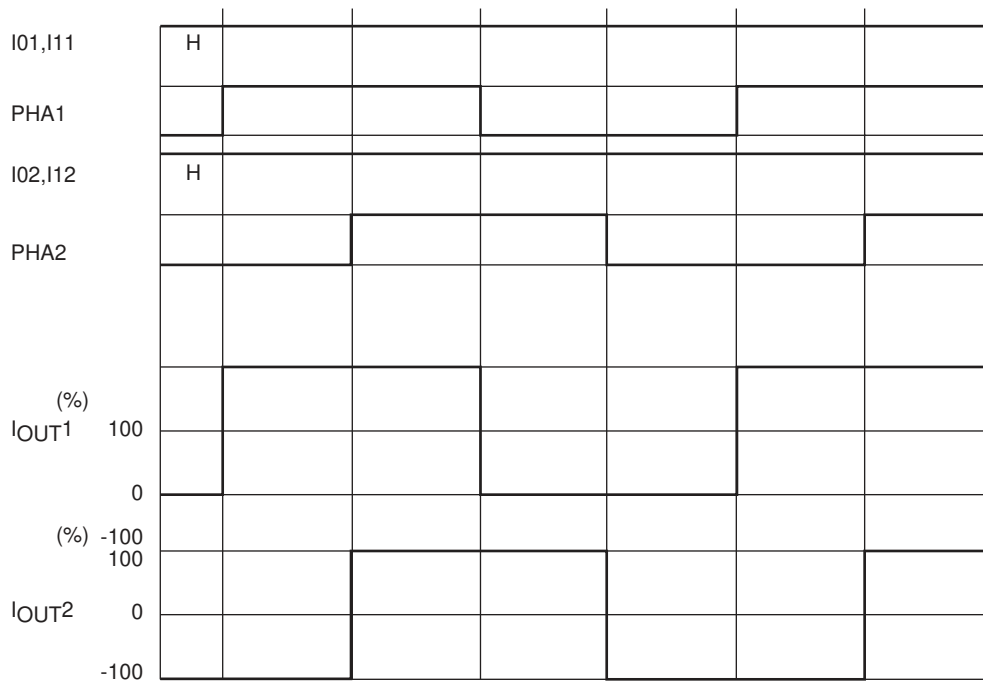

LV8743V

1-2 phase commutation (Channels 1 and 2, CW mode)

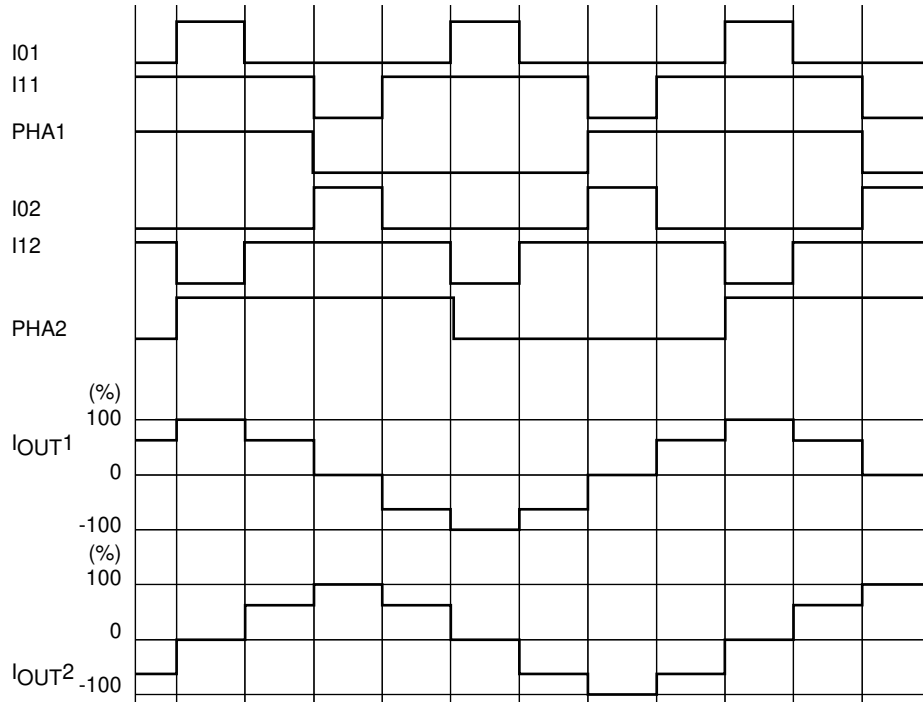

W1-2 phase commutation (Channels 1 and 2, CW mode)

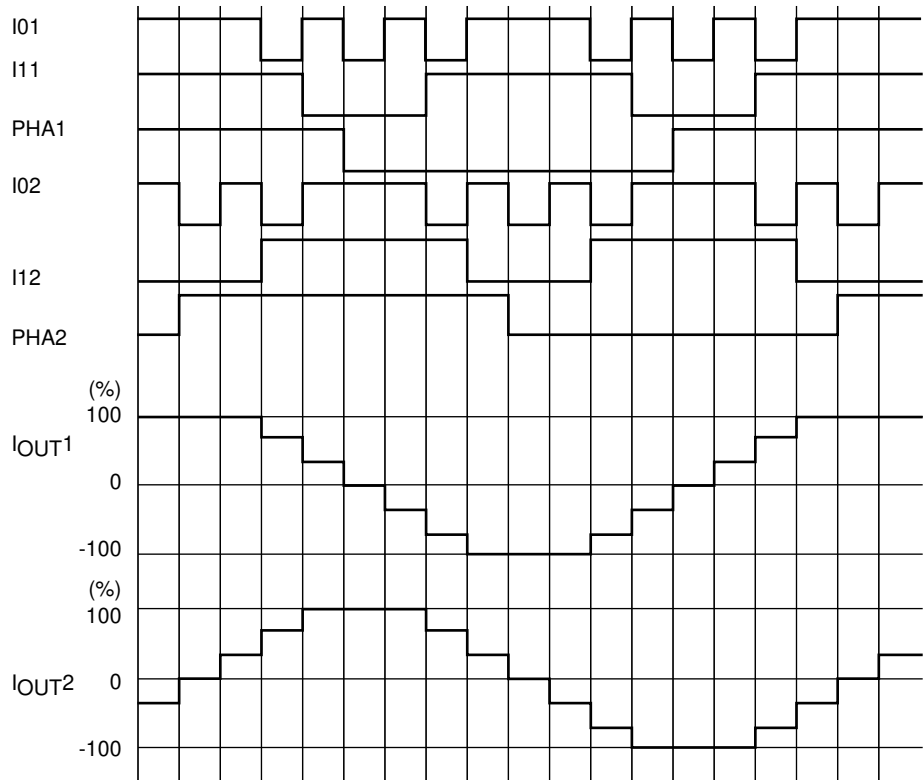

LV8743V

Switching Regulator Controller

(1) Regulator block diagram

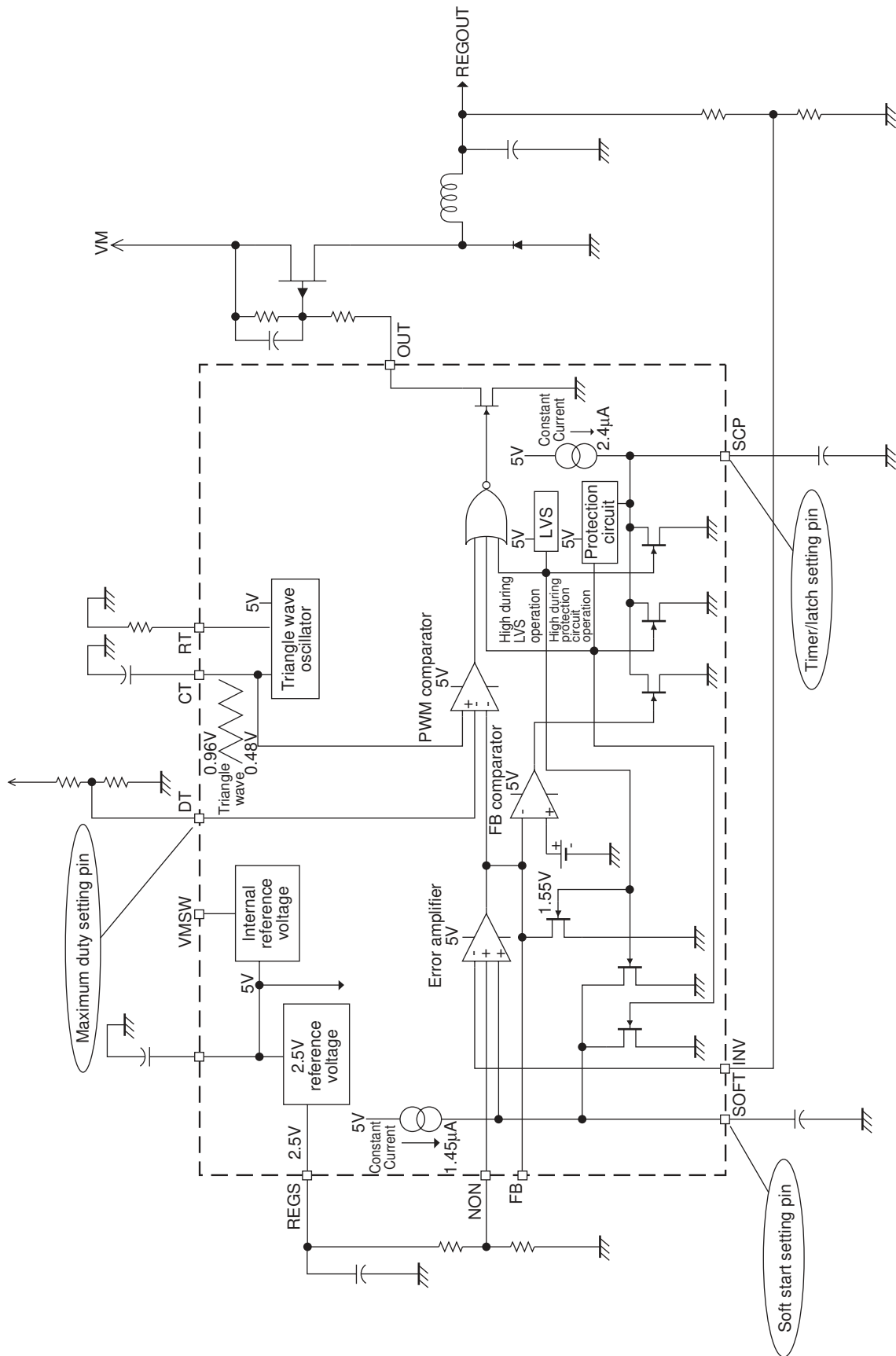

LV8743V

(2) Timing chart

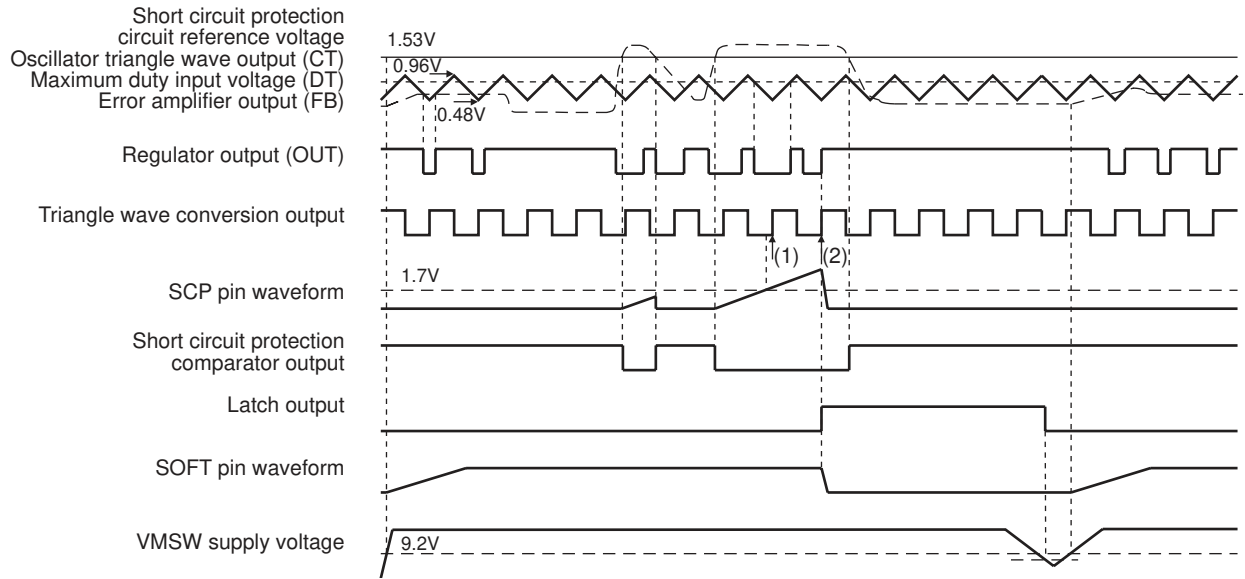

(3) SOFT pin constant setting (Soft start setting)

The switching regulator's soft start operation is set by the value of the capacitor connected between the SOFT pin and ground.

Use the following equation to determine the value of this capacitor.

$$\begin{aligned} \text{Soft start time : } T_{\text{soft}} & \quad T_{\text{soft}} \approx C \times V/I \text{ [sec]} \\ & \quad V : \text{Error amplifier noninverting input voltage (NON3/NON4)} \\ & \quad I : \text{SOFT pin charge current } 1.45\mu\text{A, typical} \end{aligned}$$

(4) SCP pin constant setting (Timer/latch setting)

The time until the output is turned off when the regulator output is shorted is set with the value of the capacitor connected between the SCP pin and ground.

Use the following equation to determine the value of this capacitor.

$$\begin{aligned} \text{Timer/latch operating time : } T_{\text{scp}} & \quad T_{\text{scp}} \approx C \times V/I \text{ [sec]} \\ & \quad V : \text{Threshold voltage (1.7V, typical)} \\ & \quad I : \text{SCP pin charge current (2.4}\mu\text{A, typical)} \end{aligned}$$

(5) RT pin constant setting (Capacitor charge/discharge current setting)

The charge/discharge current for the capacitor connected to the CT pin used to generate the triangle wave is set with the value of the resistor connected between the RT pin and ground.

Use the following equation to determine the value of this resistor.

$$\begin{aligned} \text{Charge/discharge current : } I_{\text{rt}} & \quad I_{\text{rt}} \approx V/R \text{ [A]} \\ & \quad V : \text{The R pin voltage (0.96V, typical)} \end{aligned}$$

(6) CT pin constant setting (Triangle wave oscillator frequency setting)

The triangle wave oscillator frequency can be set with the value of the capacitor connected between the CT pin and ground. (Note that this setting operates in conjunction with the RT pin charge/discharge current setting.)

Use the following equation to determine the value of this capacitor.

$$\begin{aligned} \text{Triangle wave oscillator frequency : } F_{\text{osc}} & \quad F_{\text{osc}} \approx 1/\{2 \times C \times V/I\} \text{ [Hz]} \\ & \quad V : \text{Triangle wave amplitude (0.48V, typical when } F_{\text{osc}} = 10\text{kHz)} \\ & \quad * : \text{Note that the amplitude increases with the frequency.} \\ & \quad I : \text{Capacitor charge/discharge current} \\ & \quad \quad \quad \text{(See item (5), RT pin constant setting.)} \end{aligned}$$

LV8743V

Application Circuit

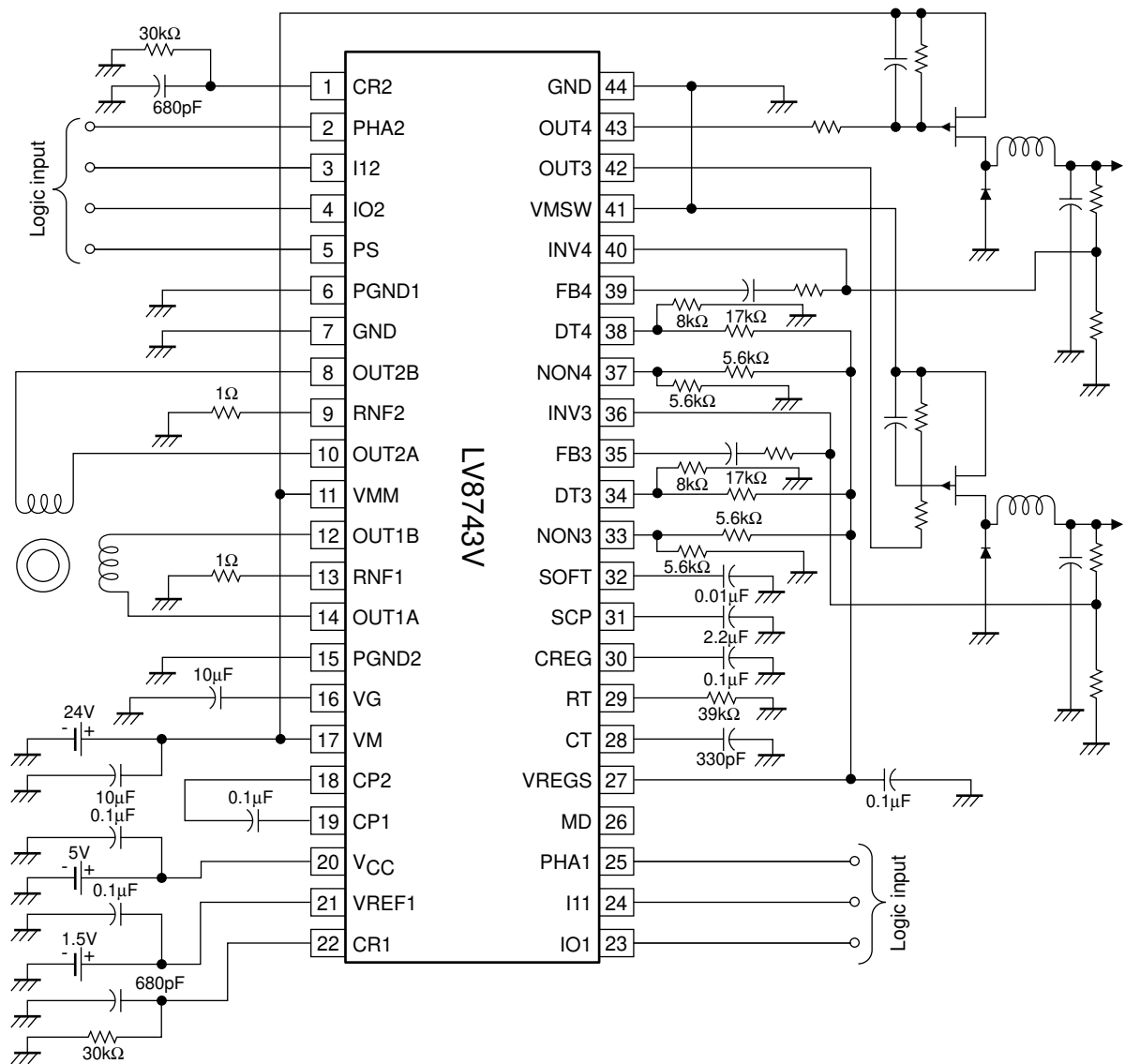

- SANYO Semiconductor Co.,Ltd. assumes no responsibility for equipment failures that result from using products at values that exceed, even momentarily, rated values (such as maximum ratings, operating condition ranges, or other parameters) listed in products specifications of any and all SANYO Semiconductor Co.,Ltd. products described or contained herein.
- SANYO Semiconductor Co.,Ltd. strives to supply high-quality high-reliability products, however, any and all semiconductor products fail or malfunction with some probability. It is possible that these probabilistic failures or malfunction could give rise to accidents or events that could endanger human lives, trouble that could give rise to smoke or fire, or accidents that could cause damage to other property. When designing equipment, adopt safety measures so that these kinds of accidents or events cannot occur. Such measures include but are not limited to protective circuits and error prevention circuits for safe design, redundant design, and structural design.
- In the event that any or all SANYO Semiconductor Co.,Ltd. products described or contained herein are controlled under any of applicable local export control laws and regulations, such products may require the export license from the authorities concerned in accordance with the above law.
- No part of this publication may be reproduced or transmitted in any form or by any means, electronic or mechanical, including photocopying and recording, or any information storage or retrieval system, or otherwise, without the prior written consent of SANYO Semiconductor Co.,Ltd.
- Any and all information described or contained herein are subject to change without notice due to product/technology improvement, etc. When designing equipment, refer to the "Delivery Specification" for the SANYO Semiconductor Co.,Ltd. product that you intend to use.
- Information (including circuit diagrams and circuit parameters) herein is for example only; it is not guaranteed for volume production.
- Upon using the technical information or products described herein, neither warranty nor license shall be granted with regard to intellectual property rights or any other rights of SANYO Semiconductor Co.,Ltd. or any third party. SANYO Semiconductor Co.,Ltd. shall not be liable for any claim or suits with regard to a third party's intellectual property rights which has resulted from the use of the technical information and products mentioned above.

This catalog provides information as of February, 2007. Specifications and information herein are subject to change without notice.