



Is Now Part of



ON Semiconductor®

To learn more about ON Semiconductor, please visit our website at
www.onsemi.com

Please note: As part of the Fairchild Semiconductor integration, some of the Fairchild orderable part numbers will need to change in order to meet ON Semiconductor's system requirements. Since the ON Semiconductor product management systems do not have the ability to manage part nomenclature that utilizes an underscore (_), the underscore (_) in the Fairchild part numbers will be changed to a dash (-). This document may contain device numbers with an underscore (_). Please check the ON Semiconductor website to verify the updated device numbers. The most current and up-to-date ordering information can be found at www.onsemi.com. Please email any questions regarding the system integration to Fairchild_questions@onsemi.com.

ON Semiconductor and the ON Semiconductor logo are trademarks of Semiconductor Components Industries, LLC dba ON Semiconductor or its subsidiaries in the United States and/or other countries. ON Semiconductor owns the rights to a number of patents, trademarks, copyrights, trade secrets, and other intellectual property. A listing of ON Semiconductor's product/patent coverage may be accessed at www.onsemi.com/site/pdf/Patent-Marking.pdf. ON Semiconductor reserves the right to make changes without further notice to any products herein. ON Semiconductor makes no warranty, representation or guarantee regarding the suitability of its products for any particular purpose, nor does ON Semiconductor assume any liability arising out of the application or use of any product or circuit, and specifically disclaims any and all liability, including without limitation special, consequential or incidental damages. Buyer is responsible for its products and applications using ON Semiconductor products, including compliance with all laws, regulations and safety requirements or standards, regardless of any support or applications information provided by ON Semiconductor. "Typical" parameters which may be provided in ON Semiconductor data sheets and/or specifications can and do vary in different applications and actual performance may vary over time. All operating parameters, including "Typicals" must be validated for each customer application by customer's technical experts. ON Semiconductor does not convey any license under its patent rights nor the rights of others. ON Semiconductor products are not designed, intended, or authorized for use as a critical component in life support systems or any FDA Class 3 medical devices or medical devices with a same or similar classification in a foreign jurisdiction or any devices intended for implantation in the human body. Should Buyer purchase or use ON Semiconductor products for any such unintended or unauthorized application, Buyer shall indemnify and hold ON Semiconductor and its officers, employees, subsidiaries, affiliates, and distributors harmless against all claims, costs, damages, and expenses, and reasonable attorney fees arising out of, directly or indirectly, any claim of personal injury or death associated with such unintended or unauthorized use, even if such claim alleges that ON Semiconductor was negligent regarding the design or manufacture of the part. ON Semiconductor is an Equal Opportunity/Affirmative Action Employer. This literature is subject to all applicable copyright laws and is not for resale in any manner.

FAN2500

100 mA CMOS LDO Regulator

Features

- Ultra-Low Power Consumption
- 100 mV Dropout Voltage at 100 mA
- 25 μ A Ground Current at 100 mA
- Enable / Shutdown Control
- SOT23-5 package
- Thermal Limiting
- 300 mA Peak Current

Applications

- Mobile Phones and Accessories
- Portable Cameras and Video Recorders
- Laptop, Notebook, and Palmtop Computers

Description

The FAN2500 micropower low-dropout voltage regulator utilizes CMOS technology to offer a new level of cost-effective performance in mobile handsets, laptop and notebook portable computers, and other portable devices. Features include extremely low power consumption, low shutdown current, low dropout voltage, exceptional loop stability able to accommodate a wide variety of external capacitors, and a compact SOT23-5 surface-mount package. The FAN2500 offers significant improvements over older BiCMOS designs and is pin-compatible with many popular devices. The output is thermally protected against overload.

FAN2500: pin 4 – ADJ, allows the user to adjust the output voltage over a wide range using an external voltage divider.

FAN2500-XX: pin 4 – BYP, to which a bypass capacitor may be connected for optimal noise performance. Output voltage is fixed, indicated by the suffix XX.

The standard fixed output voltages available are 2.5 V, 3.0 V, and 3.3 V.

Ordering Information

Part Number	V _{OUT}	Pin 4 Function	Top Mark	Package	Packing Method
FAN2500S25X	2.5	Bypass	ACE	SOT-23 5L	Tape and Reel
FAN2500S30X	3.0	Bypass	ACW	SOT-23 5L	Tape and Reel
FAN2500S33X	3.3	Bypass	AC3	SOT-23 5L	Tape and Reel
FAN2500SX	Adj.	Adjust	ACA	SOT-23 5L	Tape and Reel

Tape and Reel Information

Quantity	Reel Size	Width
3000	7 inches	8 mm

Block Diagram

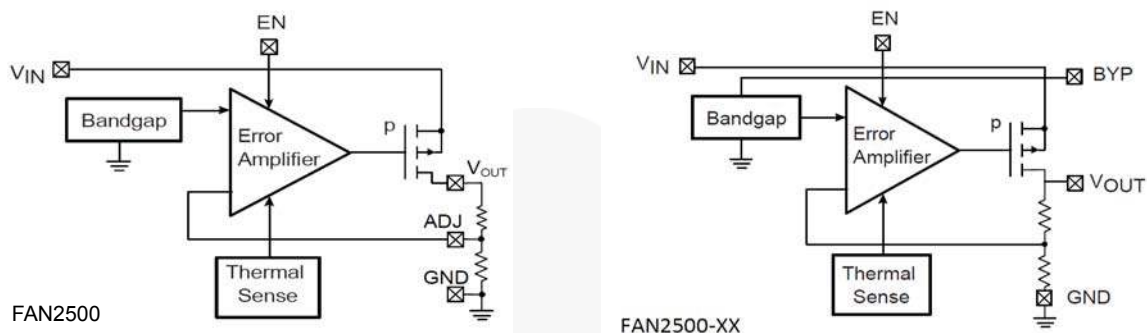

Figure 1. Block Diagram

Pin Configuration

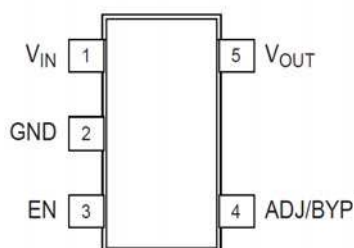

Figure 2. Pin Configuration

Pin No.	FAN2500	FAN2500-XX
1.	V_{IN}	V_{IN}
2.	GND	GND
3.	EN	EN
4.	ADJ	BYP
5.	V_{OUT}	V_{OUT}

Pin Descriptions

Pin Name	Pin No.	Type	Functional Description
ADJ	4	Input	FAN2500 Adjust Ratio of potential divider from V_{OUT} to ADJ determines output voltage
BYP	4	Passive	FAN2500-XX Bypass Connect a 470 pF capacitor for noise reduction
EN	3	Digital Input	Enable 0: Shutdown V_{OUT} 1: Enable V_{OUT}
V_{IN}	1	Power In	Voltage Input Supply voltage input
V_{OUT}	5	Power Out	Voltage Output Regulated output voltage
GND	2	Power	Ground

Absolute Maximum Ratings⁽¹⁾

Stresses exceeding the absolute maximum ratings may damage the device. The device may not function or be operable above the recommended operating conditions and stressing the parts to these levels is not recommended. In addition, extended exposure to stresses above the recommended operating conditions may affect device reliability. The absolute maximum ratings are stress ratings only.

Parameter	Min.	Max.	Unit
Power Supply Voltages			
V _{IN} (Measured to GND)	0	7	V
Enable Input (EN)			
Applied Voltage (Measured to GND) ⁽²⁾	0	7	V
Power			
Dissipation ⁽³⁾	Internally Limited		
Temperature			
Junction	-65	150	°C
Lead Soldering (5 s)		260	°C
Storage	-65	150	°C
Electrostatic Discharge ⁽⁴⁾	4		kV

Notes:

- Functional operation under any of these conditions is NOT implied. Performance and reliability are guaranteed only if Recommended Operating Conditions are not exceeded.
- Applied voltage must be current limited to specified range.
- Based upon thermally limited junction temperature:

$$P_D = \frac{T_{J(max)} - T_A}{\theta_{JA}}$$

- Human Body Model is 4 kV minimum using Mil Std. 883E, method 3015.7. Machine Model is 400 V minimum using JEDEC method A115-A.

Recommended Operating Conditions

The recommended Operating Conditions table defines the conditions for actual device operation. Recommended operating conditions are specified to ensure optimal performance to the datasheet specifications. Fairchild does not recommend exceeding them or designing to Absolute Maximum Ratings.

Symbol	Parameter	Min.	Nom.	Max.	Unit
V _{IN}	Input Voltage Range	2.7		6.5	V
V _{EN}	Enable Input Voltage	0		V _{IN}	V
T _J	Junction Temperature	-40		+125	°C
θ _{JA}	Thermal Resistance, Junction to Air		220		°C/W
θ _{JC}	Thermal Resistance, Junction to Case		130		°C/W

Electrical Characteristics^(5, 6)

Symbol	Parameter	Conditions	Min.	Typ.	Max.	Units
Regulator						
V_{DO}	Drop-Out Voltage	$I_{OUT} = 100 \mu A$		2.5	4.0	mV
		$I_{OUT} = 50 \text{ mA}$		50	75	mV
		$I_{OUT} = 100 \text{ mA}$		100	140	mV
ΔV_O	Output Voltage Accuracy		-2		2	%
ΔV_{REF}	Reference Voltage Accuracy, Adjustable Mode		1.24	1.32	1.40	V
$\Delta V_O^{(7)}$	Output Voltage Accuracy, Adjustable Mode		-6		6	%
I_{GND}	Ground Pin Current	$I_{OUT} = 100 \text{ mA}$			50	μA
Protection						
	Current Limit		Thermally Protected			
I_{GSD}	Shutdown Current	EN = 0 V			1	μA
T_{SH}	Thermal Protection Shutdown Temperature		150			$^{\circ}C$
Enable Input						
V_{IL}	Logic Low Voltage			1.2	0.4	V
V_{IH}	Logic High Voltage		2.0	1.4		V
I_{IH}	Input Current High				1	μA
I_I	Input Current Low				1	μA

Switching Characteristics^(5, 6)

Parameter	Max.	Unit
Enable Input ⁽⁸⁾		
Response Time	500	μsec

Performance Characteristics^(5, 6)

Symbol	Parameter	Conditions	Typ.	Max.	Unit
$\frac{\Delta V_{OUT}}{\Delta V_{IN}}$	Line Regulation	$V_{IN} = (V_{OUT} + 1) \text{ to } 6.5 \text{ V}$	0.3		% / V
$\frac{\Delta V_{OUT}}{V_{OUT}}$	Load Regulation	$I_{OUT} = 0.1 \text{ to } 100 \text{ mA}$	1.0	2.0	%
e_N	Output Noise	f = 10 Hz to 1 kHz at V_{IN} , $C_{OUT} = 10 \mu F$, $C_{BYP} = 0.01 \mu F$	< 7.00		$\mu V \sqrt{\text{Hz}}$
		f > 10 kHz at V_{IN} , $C_{OUT} = 10 \mu F$, $C_{BYP} = 0.01 \mu F$	< 0.01		
PSRR	Power Supply Rejection	f = 120 Hz at V_{IN} , $C_{OUT} = 10 \mu F$, $C_{BYP} = 0.01 \mu F$	43		dB

Notes:

- Unless otherwise stated; $T_A = 25^{\circ}C$, $V_{IN} = V_{OUT} + 1 \text{ V}$, $I_{OUT} = 100 \mu A$, and $V_{IH} > 2.0 \text{ V}$.
- Bold values indicate $-40 \leq T_J \leq 125^{\circ}C$.
- The adjustable version has a band-gap voltage range of 1.24 V to 1.40 V with a nominal value of 1.32 V.
- When using repeated cycling.

Typical Performance Characteristics

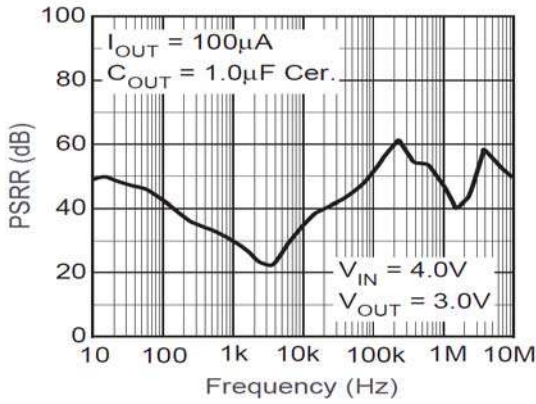

Figure 3. Power Supply Rejection Ratio

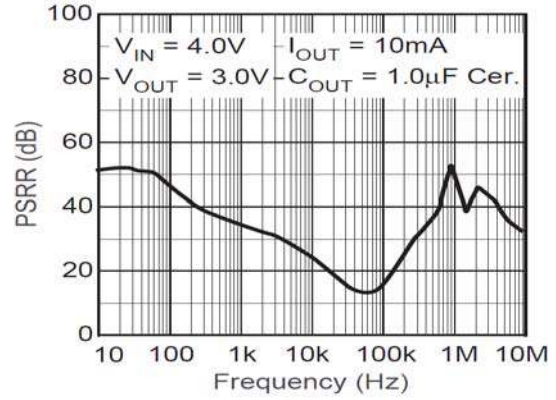

Figure 4. Power Supply Rejection Ratio

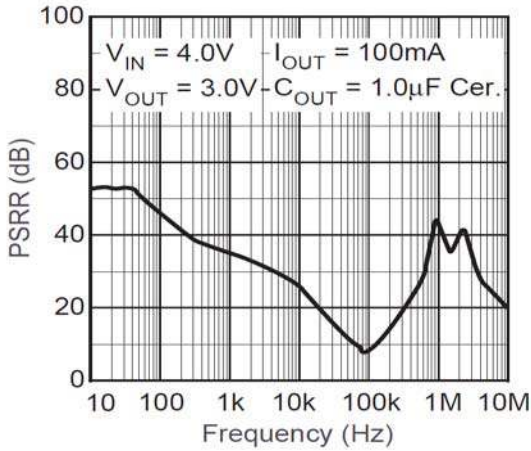

Figure 5. Power Supply Rejection Ratio

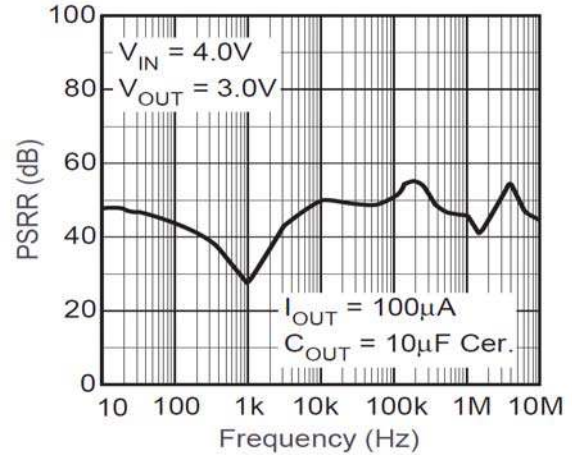

Figure 6. Power Supply Rejection Ratio

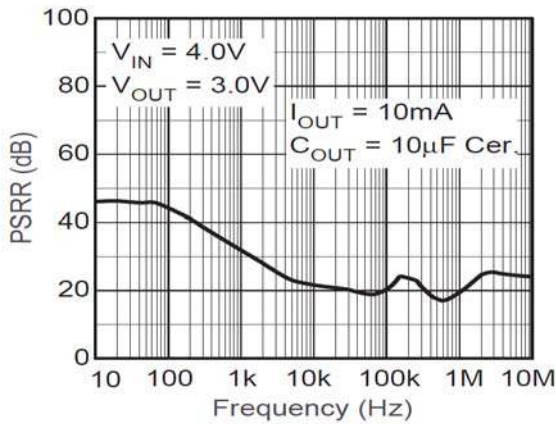

Figure 7. Power Supply Rejection Ratio

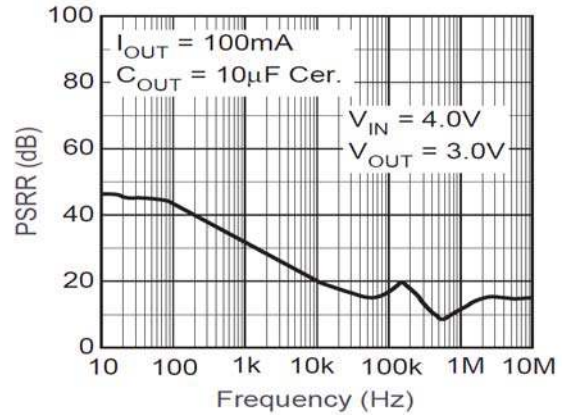

Figure 8. Power Supply Rejection Ratio

Typical Performance Characteristics (Continued)

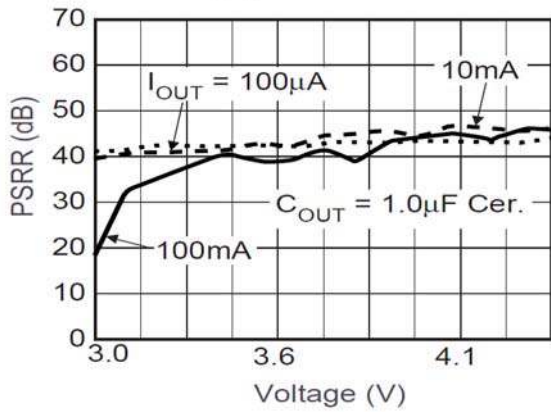

Figure 9. PSRR vs. Voltage Drop

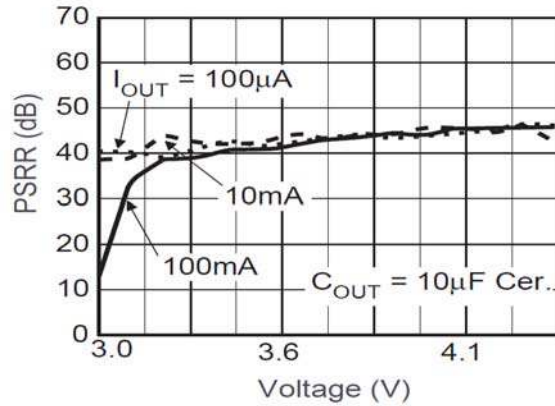

Figure 10. PSRR vs. Voltage Drop

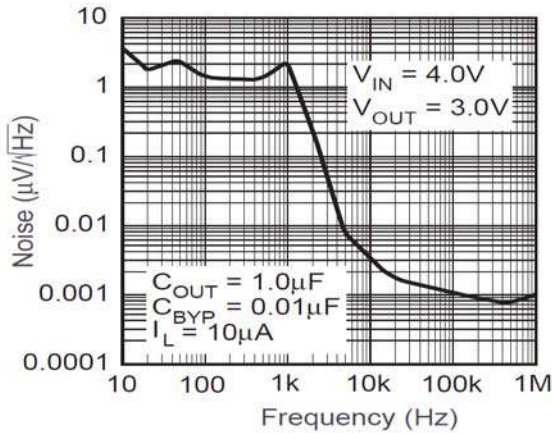

Figure 11. Noise Performance

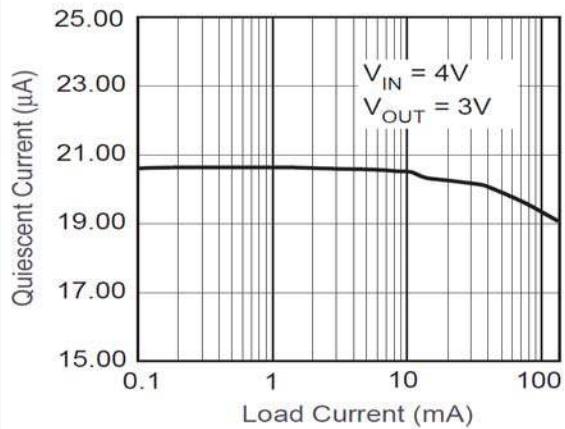

Figure 12. Ground Pin Current

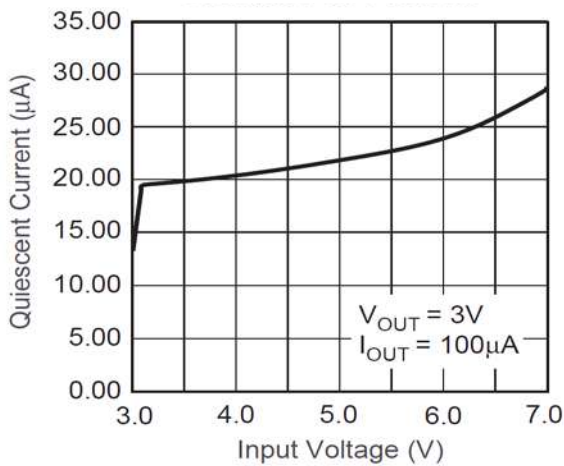

Figure 13. Ground Pin Current

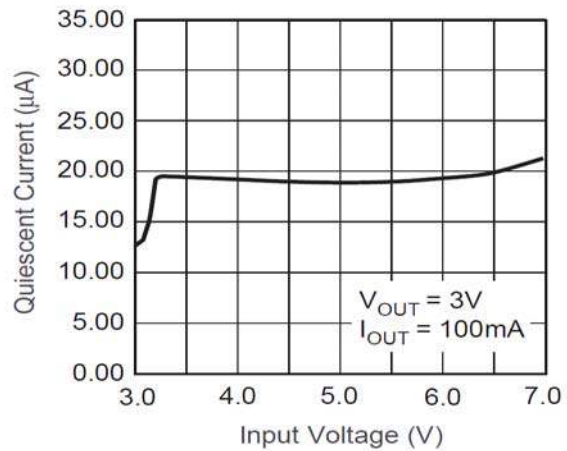

Figure 14. Ground Pin Current

Typical Performance Characteristics (Continued)

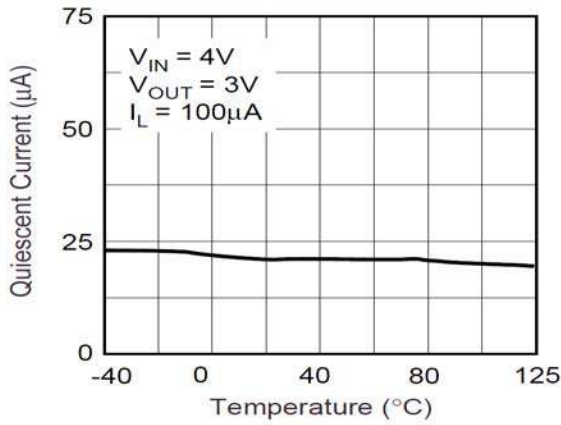

Figure 15. Ground Pin Current

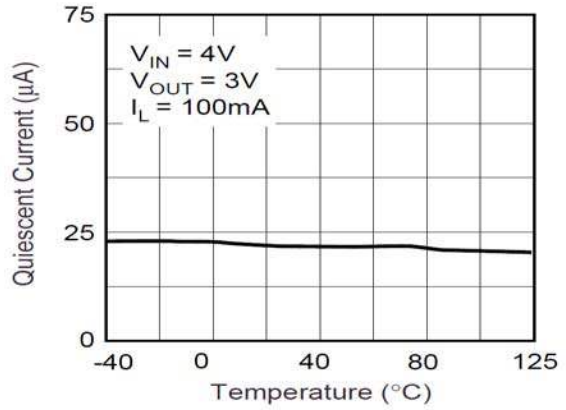

Figure 16. Ground Pin Current

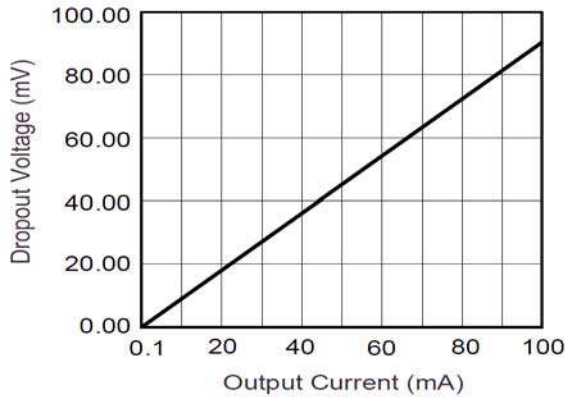

Figure 17. Dropout Voltage

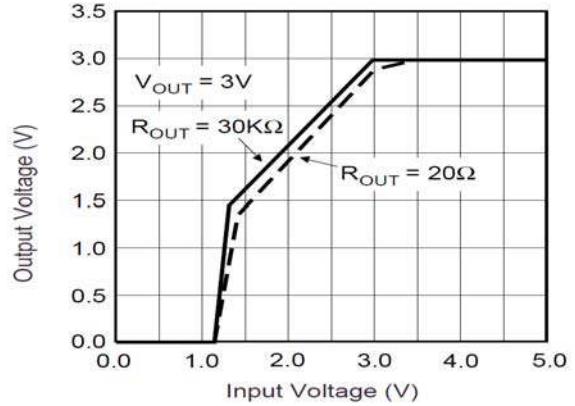

Figure 18. Dropout Characteristics

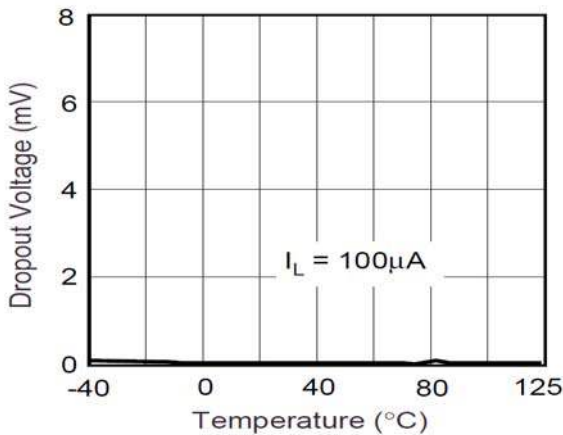

Figure 19. Dropout Voltage

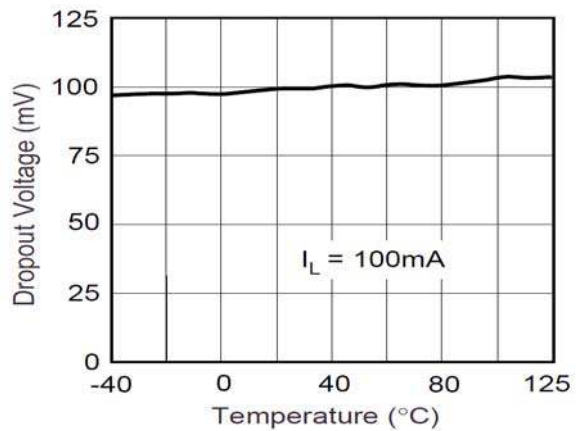

Figure 20. Dropout Voltage

Typical Performance Characteristics (Continued)

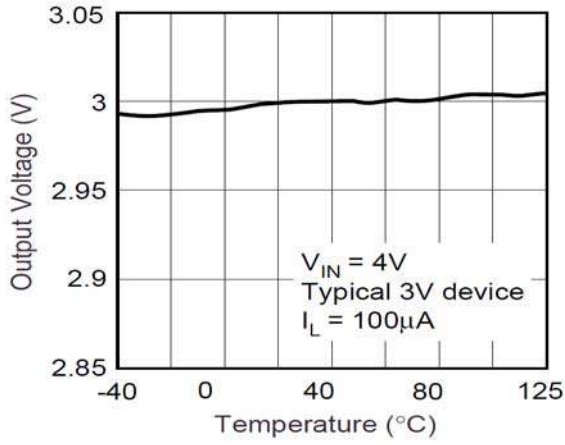

Figure 21. Output Voltage vs. Temperature

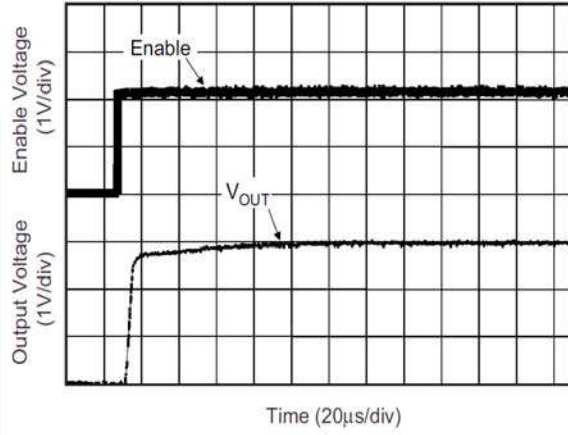

Figure 22. Enable Pin Delay

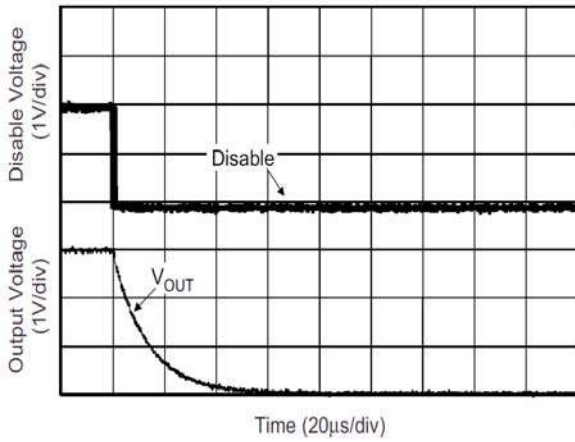

Figure 23. Shutdown Delay

Functional Description

Designed utilizing CMOS process technology, the FAN2500 is carefully optimized for use in compact battery-powered devices. The FAN2500 offers a unique combination of low power consumption, extremely low dropout voltages, high tolerance for a variety of output capacitors, and the ability to disable the output to less than 1 μA under user control. In the circuit, a difference amplifier controls the current through a series-pass P-channel MOSFET, comparing the load voltage at the output with an onboard low-drift band-gap reference. The series resistance of the pass P-channel MOSFET is approximately 1 Ω , resulting in an unusually low dropout voltage under load compared to older bipolar pass-transistor designs.

Protection circuitry is provided onboard for overload conditions. If the device reaches temperatures exceeding the specified maximums, an onboard circuit shuts down the output and it remains suspended until it has cooled before re-enabling. The user can shut down the device using the Enable control pin at any time.

Careful design of the output regulator amplifier assures loop stability over a wide range of ESR values in the external output capacitor. A wide range of values and types can be accommodated, allowing the user to select a capacitor meeting space, cost, and performance requirements; and still enjoy reliable operation over temperature, load, and tolerance variations.

Depending on the model selected, a number of control and status functions are available to enhance the operation of the LDO regulator. An Enable pin, available on all devices, allows the user to shut down the regulator output to conserve power, reducing supply current to less than 1 μA . The adjustable-voltage versions of the device utilize pin 4 to connect to an external voltage divider that feeds back to the regulator error amplifier, thereby setting the voltage as desired. Two other functions are available at pin 4 in the fixed-voltage versions: in noise-sensitive applications, an external bypass capacitor connection is provided that allows the user to achieve optimal noise performance at the output, while the error output functions as a diagnostic flag to indicate that the output voltage has dropped more than 5% below the nominal fixed voltage.

Applications Information

External Capacitors – Selection

FAN2500 supports a wide variety of capacitors compared to other LDO products. An innovative design approach offers significantly reduced sensitivity to ESR (Equivalent Series Resistance), which degrades regulator loop stability in older designs. While the improvements greatly simplify the design task, capacitor quality still must be considered to achieve optimal circuit performance.

In general, ceramic capacitors offer superior ESR performance at a lower cost and a smaller case size than tantalum. Those with X7R or Y5V dielectric offer the best temperature coefficient characteristics. The combination of tolerance and variation over temperature in some capacitor types can result in significant variations, resulting in unstable performance over rated conditions.

Input Capacitor

An input capacitor of 2.2 μF (nominal value) or greater, connected between the Input pin and ground, located in close proximity to the device, improves transient response and noise rejection. Higher values offer superior input ripple rejection and transient response. An input capacitor is recommended when the input source, either a battery or a regulated AC voltage, is located far from the device. Any good-quality ceramic, tantalum, or metal film capacitor gives acceptable performance; however, tantalum capacitors with a surge current rating appropriate to the application must be selected to avoid catastrophic failure.

Output Capacitor

An output capacitor is required to maintain regulator loop stability. Unlike many other LDO regulators, the FAN2500 is nearly insensitive to output capacitor ESR. Stable operation is achieved with a wide variety of capacitors with ESR values ranging from 10 m Ω to 10 Ω or more. Tantalum, aluminum electrolytic, or multilayer ceramic can be used. A nominal value of at least 1 μF is recommended.

Bypass Capacitor (FAN2500 Only)

In the fixed-voltage configuration, connecting a capacitor between the Bypass pin and ground can significantly reduce noise on the output. Values ranging from 470 pF to 10 nF can be used, depending on the sensitivity to output noise in the application.

At the high-impedance Bypass pin, care must be taken in the circuit layout to minimize noise pickup and capacitors must be selected to minimize current loading (leakage). Noise pickup from external sources can be considerable. Leakage currents into the Bypass pin directly affect regulator accuracy and should be kept as low as possible; high-quality ceramic and film types are recommended for their low leakage characteristics. Cost-sensitive applications not concerned with noise can omit this capacitor.

Control Functions

Enable Pin

Applying a voltage of 0.4 V or less at the Enable pin disables the output, reducing the quiescent output current to less than 1 μA ; while a voltage of 2.0 V or greater enables the device. If this shutdown function is not needed, the pin can be connected to the V_{IN} pin. Allowing this pin to float causes erratic operation.

Thermal Protection

FAN2500 can supply high peak output currents of up to 1 A for brief periods. However, this output load causes the device temperature to exceed maximum ratings due to power dissipation. During output overload conditions, when the die temperature exceeds the shutdown limit temperature of 150°C, onboard thermal protection disables the output until the temperature drops below this limit, at which point the output is re-enabled. During a thermal shutdown situation, the user may assert the power-down function at the Enable pin, reducing power consumption to the minimum level $I_{GND} \cdot V_{IN}$.

Thermal Characteristics

FAN2500 can supply 100 mA at the specified output voltage with an operating die (junction) temperature of up to 125°C. Once the power dissipation and thermal resistance is known, the maximum junction temperature of the device can be calculated. While the power dissipation is calculated from known electrical parameters, the thermal resistance is a result of the thermal characteristics of the compact SOT23-5 surface-mount package and the surrounding PC board copper to which it is mounted.

The power dissipation is equal to the product of the input to output voltage differential and the output current, plus the ground current multiplied by the input voltage, or:

$$P_D = (V_{IN} - V_{OUT})I_{OUT} + V_{IN}I_{GND}$$

The ground pin current, I_{GND} , can be found in the charts provided in the Electrical Characteristics section.

The relationship describing the thermal behavior of the package is:

$$P_{D(max)} = \left\{ \frac{T_{J(max)} - T_A}{\theta_{JA}} \right\}$$

where $T_{J(max)}$ is the maximum allowable junction temperature of the die, which is 125°C, and T_A is the ambient operating temperature. θ_{JA} is dependent on the surrounding PC board layout and can be empirically obtained. While the θ_{JC} (junction-to-case) of the SOT23-5 package is specified at 130°C/W, the θ_{JA} of the minimum PWB footprint is at least 235°C/W. This can be improved by providing a heat sink of surrounding copper ground on the PCB.

Depending on the size of the copper area, the resulting θ_{JA} can range from approximately 180°C/W for one square inch to nearly 130°C/W for four square inches. The addition of backside copper with through-holes, stiffeners, and other enhancements can reduce this value. The heat contributed by the dissipation of other devices nearby must be included in design considerations.

Once the limiting parameters in these two relationships have been determined, the design can be modified to ensure that the device remains within specified operating conditions at all times.

If overload conditions are not considered, it is possible for the device to enter a thermal cycling loop, in which the circuit enters a shutdown condition, cools, re-enables, and then again overheats and shuts down repeatedly due to an unmanaged fault condition.

Operational of Adjustable Version

The adjustable version of the FAN2500 includes an input pin, ADJ, which allows the user to select an output voltage ranging from 1.8 V to near V_{IN} , using an external resistor divider. The voltage V_{ADJ} presented to the ADJ pin is fed to the onboard error amplifier, which adjusts the output voltage until V_{ADJ} is equal to the onboard bandgap reference voltage of 1.32 V (typ). The equation is:

$$V_{OUT} = 1.32V \times \left[1 + \frac{R_{upper}}{R_{lower}} \right]$$

The total value of the resistor chain should not exceed 250 kΩ total to keep the error amplifier biased during no-load conditions. Programming output voltages very near V_{IN} need to allow for the magnitude and variation of the dropout voltage V_{DO} over load, supply, and temperature variations. Note that the low-leakage MOSFET input to the CMOS error amplifier induces no bias current error to the calculation.

General PCB Layout Considerations

To achieve the full performance of the device, careful circuit layout and grounding technique must be observed. Establishing a small local ground, to which the GND pin, the output, and bypass capacitors are connected; is recommended. The input capacitor should be grounded to the main ground plane. The quiet local ground is routed back to the main ground plane using feed-through vias. In general, the high-frequency compensation components (input, bypass, and output capacitors) should be located as close to the device as possible. The proximity of the output capacitor is especially important to achieve optimal noise compensation from the onboard error amplifier, especially during high load conditions. A large copper area in the local ground provides the heat sinking discussed above when high power dissipation significantly increases the temperature of the device.

Component-side copper provides significantly better thermal performance for this surface-mount device, compared to that obtained when using only copper planes on the underside.

Physical Dimensions

SOT-23

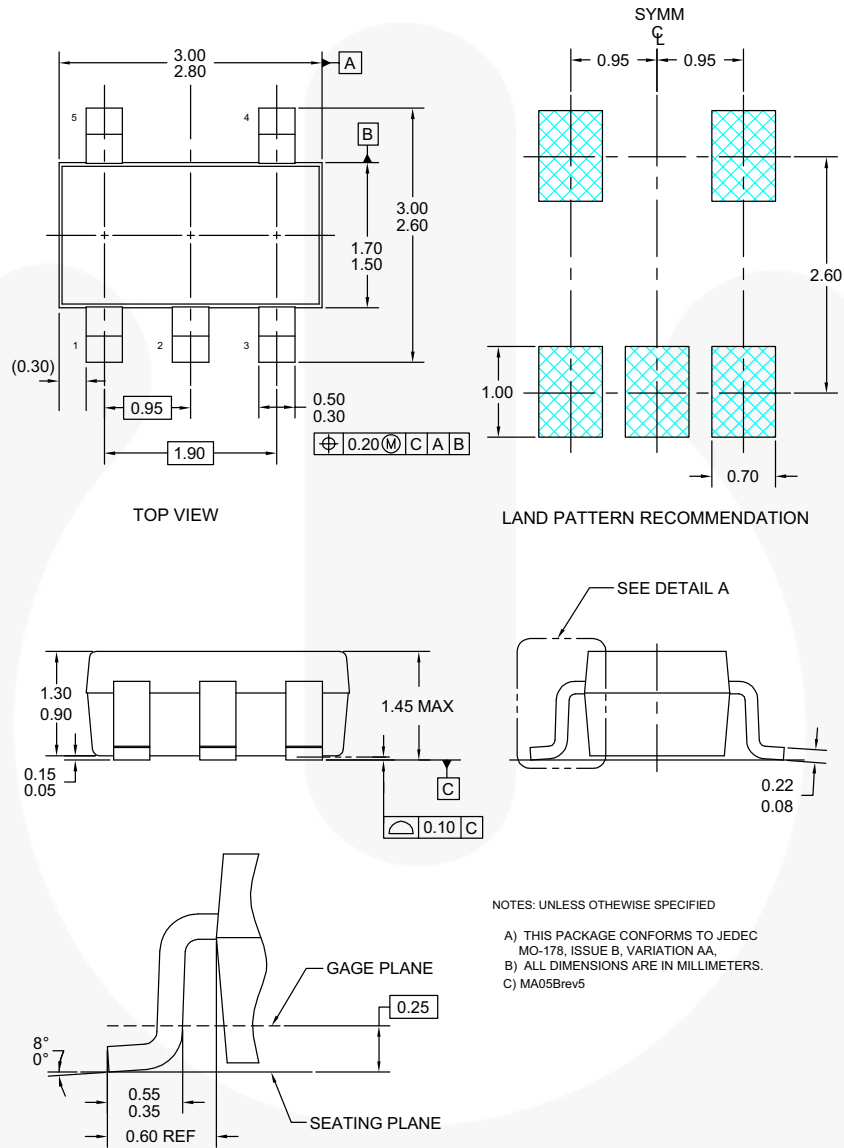

Figure 24. 5-LEAD, SOT-23, JEDEC MO-178, 1.6 mm

Package drawings are provided as a service to customers considering Fairchild components. Drawings may change in any manner without notice. Please note the revision and/or date on the drawing and contact a Fairchild Semiconductor representative to verify or obtain the most recent revision. Package specifications do not expand the terms of Fairchild's worldwide terms and conditions, specifically the warranty therein, which covers Fairchild products.

Always visit Fairchild Semiconductor's online packaging area for the most recent package drawings:
<http://www.fairchildsemi.com/packaging/>

For current tape and reel specifications, visit Fairchild Semiconductor's online packaging area:
http://www.fairchildsemi.com/packaging/tr/SOT23-5L_tr.pdf



TRADEMARKS

The following includes registered and unregistered trademarks and service marks, owned by Fairchild Semiconductor and/or its global subsidiaries, and is not intended to be an exhaustive list of all such trademarks.

- | | | | |
|--------------------------|--|---------------------------------------|------------------|
| 2Cool™ | FPS™ | | Sync-Lock™ |
| AccuPower™ | F-PFS™ | PowerTrench® | SYSTEM GENERAL® |
| AX-CAP®* | FRFET® | PowerXS™ | TinyBoost™ |
| BitSiC™ | Global Power Resource SM | Programmable Active Droop™ | TinyBuck™ |
| Build it Now™ | GreenBridge™ | QFET® | TinyCalc™ |
| CorePLUS™ | Green FPS™ | QS™ | TinyLogic® |
| CorePOWER™ | Green FPS™ e-Series™ | Quiet Series™ | TINYOPTO™ |
| CROSSVOLT™ | Gmax™ | RapidConfigure™ | TinyPower™ |
| CTL™ | GTO™ | | TinyPWM™ |
| Current Transfer Logic™ | IntelliMAX™ | Saving our world, 1mW/W/kW at a time™ | TinyWire™ |
| DEUXPEED® | ISOPLANAR™ | SignalWise™ | TranSiC™ |
| Dual Cool™ | Making Small Speakers Sound Louder and Better™ | SmartMax™ | TriFault Detect™ |
| EcoSPARK® | MegaBuck™ | SMART START™ | TRUECURRENT®* |
| EfficientMax™ | MICROCOUPLER™ | Solutions for Your Success™ | μSerDes™ |
| ESBC™ | MicroFET™ | SPM® | SerDes® |
| Fairchild® | MicroPak™ | STEALTH™ | UHC® |
| Fairchild Semiconductor® | MicroPak2™ | SuperFET® | Ultra FRFET™ |
| FACT Quiet Series™ | MillerDrive™ | SuperSOT™-3 | UniFET™ |
| FACT® | MotionMax™ | SuperSOT™-6 | VCX™ |
| FAST® | mWSaver™ | SuperSOT™-8 | VisualMax™ |
| FastvCore™ | OptoHiT™ | SupreMOS® | VoltagePlus™ |
| FETBench™ | OPTOLOGIC® | SyncFET™ | XS™ |
| | OPTOPLANAR® | | |

* Trademarks of System General Corporation, used under license by Fairchild Semiconductor.

DISCLAIMER

FAIRCHILD SEMICONDUCTOR RESERVES THE RIGHT TO MAKE CHANGES WITHOUT FURTHER NOTICE TO ANY PRODUCTS HEREIN TO IMPROVE RELIABILITY, FUNCTION, OR DESIGN. FAIRCHILD DOES NOT ASSUME ANY LIABILITY ARISING OUT OF THE APPLICATION OR USE OF ANY PRODUCT OR CIRCUIT DESCRIBED HEREIN; NEITHER DOES IT CONVEY ANY LICENSE UNDER ITS PATENT RIGHTS, NOR THE RIGHTS OF OTHERS. THESE SPECIFICATIONS DO NOT EXPAND THE TERMS OF FAIRCHILD'S WORLDWIDE TERMS AND CONDITIONS, SPECIFICALLY THE WARRANTY THEREIN, WHICH COVERS THESE PRODUCTS.

LIFE SUPPORT POLICY

FAIRCHILD'S PRODUCTS ARE NOT AUTHORIZED FOR USE AS CRITICAL COMPONENTS IN LIFE SUPPORT DEVICES OR SYSTEMS WITHOUT THE EXPRESS WRITTEN APPROVAL OF FAIRCHILD SEMICONDUCTOR CORPORATION.

As used herein:

1. Life support devices or systems are devices or systems which, (a) are intended for surgical implant into the body or (b) support or sustain life, and (c) whose failure to perform when properly used in accordance with instructions for use provided in the labeling, can be reasonably expected to result in a significant injury of the user.
2. A critical component in any component of a life support, device, or system whose failure to perform can be reasonably expected to cause the failure of the life support device or system, or to affect its safety or effectiveness.

ANTI-COUNTERFEITING POLICY

Fairchild Semiconductor Corporation's Anti-Counterfeiting Policy. Fairchild's Anti-Counterfeiting Policy is also stated on our external website, www.fairchildsemi.com, under Sales Support.

Counterfeiting of semiconductor parts is a growing problem in the industry. All manufacturers of semiconductor products are experiencing counterfeiting of their parts. Customers who inadvertently purchase counterfeit parts experience many problems such as loss of brand reputation, substandard performance, failed applications, and increased cost of production and manufacturing delays. Fairchild is taking strong measures to protect ourselves and our customers from the proliferation of counterfeit parts. Fairchild strongly encourages customers to purchase Fairchild parts either directly from Fairchild or from Authorized Fairchild Distributors who are listed by country on our web page cited above. Products customers buy either from Fairchild directly or from Authorized Fairchild Distributors are genuine parts, have full traceability, meet Fairchild's quality standards for handling and storage and provide access to Fairchild's full range of up-to-date technical and product information. Fairchild and our Authorized Distributors will stand behind all warranties and will appropriately address any warranty issues that may arise. Fairchild will not provide any warranty coverage or other assistance for parts bought from Unauthorized Sources. Fairchild is committed to combat this global problem and encourage our customers to do their part in stopping this practice by buying direct or from authorized distributors.

PRODUCT STATUS DEFINITIONS

Definition of Terms

Datasheet Identification	Product Status	Definition
Advance Information	Formative / In Design	Datasheet contains the design specifications for product development. Specifications may change in any manner without notice.
Preliminary	First Production	Datasheet contains preliminary data; supplementary data will be published at a later date. Fairchild Semiconductor reserves the right to make changes at any time without notice to improve design.
No Identification Needed	Full Production	Datasheet contains final specifications. Fairchild Semiconductor reserves the right to make changes at any time without notice to improve the design.
Obsolete	Not In Production	Datasheet contains specifications on a product that is discontinued by Fairchild Semiconductor. The datasheet is for reference information only.

Rev. I64

ON Semiconductor and  are trademarks of Semiconductor Components Industries, LLC dba ON Semiconductor or its subsidiaries in the United States and/or other countries. ON Semiconductor owns the rights to a number of patents, trademarks, copyrights, trade secrets, and other intellectual property. A listing of ON Semiconductor's product/patent coverage may be accessed at www.onsemi.com/site/pdf/Patent-Marking.pdf. ON Semiconductor reserves the right to make changes without further notice to any products herein. ON Semiconductor makes no warranty, representation or guarantee regarding the suitability of its products for any particular purpose, nor does ON Semiconductor assume any liability arising out of the application or use of any product or circuit, and specifically disclaims any and all liability, including without limitation special, consequential or incidental damages. Buyer is responsible for its products and applications using ON Semiconductor products, including compliance with all laws, regulations and safety requirements or standards, regardless of any support or applications information provided by ON Semiconductor. "Typical" parameters which may be provided in ON Semiconductor data sheets and/or specifications can and do vary in different applications and actual performance may vary over time. All operating parameters, including "Typicals" must be validated for each customer application by customer's technical experts. ON Semiconductor does not convey any license under its patent rights nor the rights of others. ON Semiconductor products are not designed, intended, or authorized for use as a critical component in life support systems or any FDA Class 3 medical devices or medical devices with a same or similar classification in a foreign jurisdiction or any devices intended for implantation in the human body. Should Buyer purchase or use ON Semiconductor products for any such unintended or unauthorized application, Buyer shall indemnify and hold ON Semiconductor and its officers, employees, subsidiaries, affiliates, and distributors harmless against all claims, costs, damages, and expenses, and reasonable attorney fees arising out of, directly or indirectly, any claim of personal injury or death associated with such unintended or unauthorized use, even if such claim alleges that ON Semiconductor was negligent regarding the design or manufacture of the part. ON Semiconductor is an Equal Opportunity/Affirmative Action Employer. This literature is subject to all applicable copyright laws and is not for resale in any manner.

PUBLICATION ORDERING INFORMATION

LITERATURE FULFILLMENT:

Literature Distribution Center for ON Semiconductor
19521 E. 32nd Pkwy, Aurora, Colorado 80011 USA
Phone: 303-675-2175 or 800-344-3860 Toll Free USA/Canada
Fax: 303-675-2176 or 800-344-3867 Toll Free USA/Canada
Email: orderlit@onsemi.com

N. American Technical Support: 800-282-9855 Toll Free
USA/Canada
Europe, Middle East and Africa Technical Support:
Phone: 421 33 790 2910
Japan Customer Focus Center
Phone: 81-3-5817-1050

ON Semiconductor Website: www.onsemi.com
Order Literature: <http://www.onsemi.com/orderlit>
For additional information, please contact your local
Sales Representative