

**OMNIMATE Signal - series BL/SL 5.08
SL-SMT 5.08HC/23/180 1.5SN BK BX**

Weidmüller Interface GmbH & Co. KG
 Klingenbergstraße 16
 D-32758 Detmold
 Germany
 Fon: +49 5231 14-0
 Fax: +49 5231 14-292083
 www.weidmueller.com

Product image

Similar to illustration

High-temperature-resistant, straight, open pin header.
 Packed in box or tape. On tape and with 1.5 mm solder pin, optimised for automatic assembly. 3.2 mm solder pin suitable for reflow and wave soldering. The pin headers provide space for labelling and can be coded. HC = High Current.

General ordering data

| | |
|--------------|--|
| Type | SL-SMT 5.08HC/23/180 1.5SN BK BX |
| Order No. | 1775812001 |
| Version | PCB plug-in connector, male header, open side, THT/THR solder connection, 5.08 mm, No. of poles: 23, 180°, Solder pin length (l): 1.5 mm, tinned, black, Box |
| GTIN (EAN) | 4032248158485 |
| Qty. | 20 pc(s). |
| Product data | IEC: 400 V / 27.5 A UL: 300 V / 18.5 A |
| Packaging | Box |

**OMNIMATE Signal - series BL/SL 5.08
SL-SMT 5.08HC/23/180 1.5SN BK BX**

Weidmüller Interface GmbH & Co. KG
 Klingenbergstraße 16
 D-32758 Detmold
 Germany
 Fon: +49 5231 14-0
 Fax: +49 5231 14-292083
 www.weidmueller.com

Technical data**Dimensions and weights**

| | | | |
|--------------------------|------------|-----------------|------------|
| Width | 116.84 mm | Width (inches) | 4.6 inch |
| Height | 13.5 mm | Height (inches) | 0.531 inch |
| Height of lowest version | 12 mm | Depth | 8.5 mm |
| Depth (inches) | 0.335 inch | Net weight | 9.3 g |

System specifications

| Product family | OMNIMATE Signal - series BL/SL 5.08 | Type of connection | Board connection |
|----------------------------------|-------------------------------------|---|-----------------------|
| Mounting onto the PCB | THT/THR solder connection | Pitch in mm (P) | 5.08 mm |
| Pitch in inches (P) | 0.2 inch | Outgoing elbow | 180° |
| No. of poles | 23 | Number of solder pins per pole | 1 |
| Solder pin length (l) | 1.5 mm | Solder pin length tolerance | 0 / -0.3 mm |
| Tolerance of solder pin position | ± 0.20 mm | Solder pin dimensions | d = 1.2 mm, Octagonal |
| Solder eyelet hole diameter (D) | 1.5 mm | Solder eyelet hole diameter tolerance (D) | + 0,1 mm |
| L1 in mm | 111.76 mm | L1 in inches | 4.4 inch |
| Number of rows | 1 | Pin series quantity | 1 |
| Can be coded | Yes | Plugging cycles | 25 |
| Plugging force/pole, max. | 9 N | Pulling force/pole, max. | 7 N |

Material data

| | | | |
|---------------------------------------|----------------------------|---------------------------------------|----------------------------|
| Insulating material | LCP GF | Colour code | black |
| Colour chart (similar) | RAL 9011 | Insulating material group | IIIa |
| CTI | ≥ 175 | Insulation strength | ≥ 10 ⁸ Ω |
| Moisture Level (MSL) | 1 | UL 94 flammability rating | V-0 |
| Contact material | CuMg | Contact surface | tinned |
| Layer structure of solder connection | 1-3 µm Ni / 2-4 µm Sn matt | Layer structure of plug contact | 1-3 µm Ni / 2-4 µm Sn matt |
| Storage temperature, min. | -25 °C | Storage temperature, max. | 55 °C |
| Max. relative humidity during storage | 80 % | Operating temperature, min. | -50 °C |
| Operating temperature, max. | 100 °C | Temperature range, installation, min. | -30 °C |
| Temperature range, installation, max. | 100 °C | | |

Rated data acc. to IEC

| | | | |
|---|------------------------|---|--------|
| tested acc. to standard | IEC 60664-1, IEC 61984 | Rated current, min. no. of poles (Tu=20°C) | 27.5 A |
| Rated current, max. no. of poles (Tu=20°C) | 19 A | Rated current, min. no. of poles (Tu=40°C) | 24 A |
| Rated current, max. no. of poles (Tu=40°C) | 16.5 A | Rated voltage for surge voltage class / pollution degree II/2 | 400 V |
| Rated voltage for surge voltage class / pollution degree III/2 | 320 V | Rated voltage for surge voltage class / pollution degree III/3 | 250 V |
| Rated impulse voltage for surge voltage class/ pollution degree II/2 | 4 kV | Rated impulse voltage for surge voltage class/ pollution degree III/2 | 4 kV |
| Rated impulse voltage for surge voltage class/ contamination degree III/3 | 4 kV | | |

OMNIMATE Signal - series BL/SL 5.08 SL-SMT 5.08HC/23/180 1.5SN BK BX

Weidmüller Interface GmbH & Co. KG
Klingenbergstraße 16
D-32758 Detmold
Germany
Fon: +49 5231 14-0
Fax: +49 5231 14-292083
www.weidmueller.com

Technical data

Rated data acc. to CSA

| | | | |
|-----------------------------------|---|-----------------------------------|--|
| Institute (CSA) |  | Certificate No. (CSA) | 200039-1176845 |
| Rated voltage (Use group B / CSA) | 300 V | Rated voltage (Use group D / CSA) | 300 V |
| Rated current (Use group D / CSA) | 18.5 A | Reference to approval values | Specifications are maximum values, details - see approval certificate. |

Rated data acc. to UL 1059

| | | | |
|---------------------------------------|---|---------------------------------------|--------|
| Institute (UR) |  | Certificate No. (UR) | E60693 |
| Rated voltage (Use group B / UL 1059) | 300 V | Rated voltage (Use group D / UL 1059) | 300 V |
| Rated current (Use group B / UL 1059) | 18.5 A | Rated current (Use group D / UL 1059) | 10 A |
| Reference to approval values | Specifications are maximum values, details - see approval certificate. | | |

Packaging

| | | | |
|-----------|--------|------------|--------|
| Packaging | Box | VPE length | 25 mm |
| VPE width | 125 mm | VPE height | 200 mm |

Classifications

| | | | |
|------------|-------------|------------|-------------|
| ETIM 3.0 | EC001284 | ETIM 4.0 | EC002637 |
| ETIM 5.0 | EC002637 | ETIM 6.0 | EC002637 |
| UNSPSC | 30-21-18-10 | eClass 5.1 | 27-26-07-04 |
| eClass 6.2 | 27-26-07-04 | eClass 7.1 | 27-44-04-02 |
| eClass 8.1 | 27-44-04-02 | eClass 9.0 | 27-44-04-02 |
| eClass 9.1 | 27-44-04-02 | | |

Notes

| | |
|----------------|---|
| Notes | <ul style="list-style-type: none"> • Gold-plated contact surfaces on request • Rated current related to rated cross-section & min. No. of poles. • Diameter of solder eyelet D = 1.4+0.1mm • Solder eyelet diameter D = 1.5 + 0.1 mm, from 9 poles • P on drawing = pitch • Rated data refer only to the component itself. Clearance and creepage distances to other components are to be designed in accordance with the relevant application standards. |
| IPC conformity | Conformity: The products are developed, manufactured and delivered according international recognized standards and norms and comply with the assured properties in the data sheet resp. fulfill decorative properties in accordance with IPC-A-610 "Class 2". Further claims on the products can be evaluated on request. |

Data sheet

**OMNIMATE Signal - series BL/SL 5.08
SL-SMT 5.08HC/23/180 1.5SN BK BX**

Weidmüller Interface GmbH & Co. KG
Klingenbergstraße 16
D-32758 Detmold
Germany
Fon: +49 5231 14-0
Fax: +49 5231 14-292083
www.weidmueller.com

Technical data

Approvals

Approvals



ROHS

Conform

Downloads

| | |
|---|---|
| Approval/Certificate/Document of Conformity | CB Certificate CB Testreport Declaration of the Manufacturer |
| Brochure/Catalogue | FL DRIVES EN MB SMT EN FL DRIVES DE MB DEVICE MANUF. EN CAT 2 PORTFOLIOGUIDE EN FL BUILDING SAFETY EN FL APPL LED LIGHTING EN FLIndustr.CONTROLS EN FL MACHINE SAFETY EN FL HEATING ELECTR EN FL APPL INVERTER EN FL_BASE_STATION_EN FL ELEVATOR EN FL POWER SUPPLY EN FL 72H SAMPLE SER EN PO OMNIMATE EN |
| Engineering Data | EPLAN, WSCAD |
| Engineering Data | STEP |
| SMT white paper | Download Whitepaper |

**OMNIMATE Signal - series BL/SL 5.08
SL-SMT 5.08HC/23/180 1.5SN BK BX**

Weidmüller Interface GmbH & Co. KG
 Klingenbergstraße 16
 D-32758 Detmold
 Germany
 Fon: +49 5231 14-0
 Fax: +49 5231 14-292083
 www.weidmueller.com

Drawings

Dimensional drawing

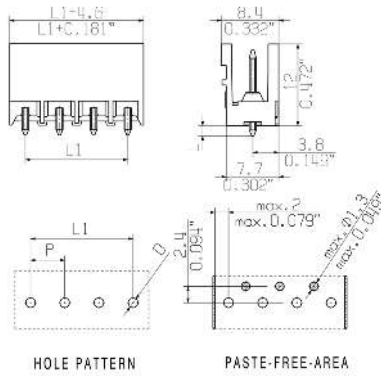

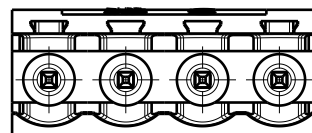
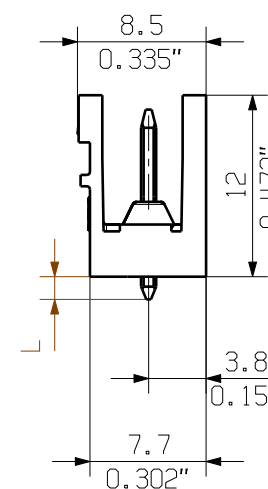
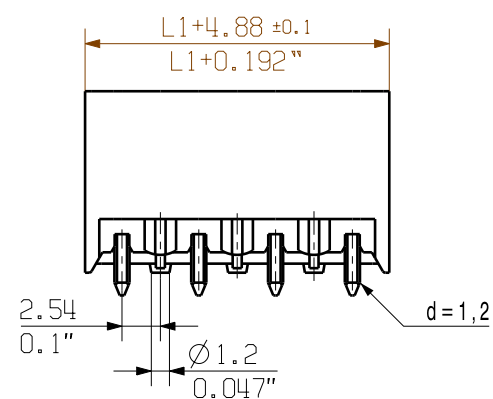

M 1:1

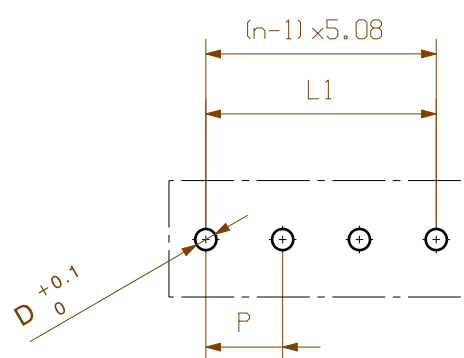
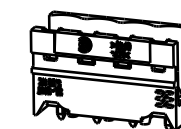

HOLE PATTERN

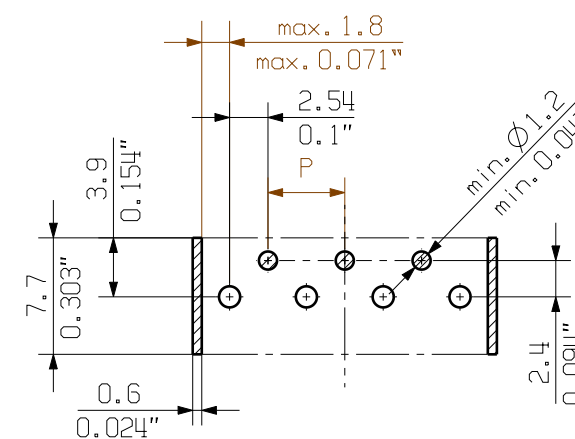

PASTE-FREE AREA

D = 1.4/0.055" or 1.5/0.059" (REFLOW SOLDERING)
RECOMMENDATION FOR AUTOMATIC ASSEMBLY
(1.4mm FOR n=2...8 / 1.5mm for n=9...24)

n = POLZAHL/NO OF POLES

P = RASTER/PITCH

SHOWN: SL-SMT 5.08HC/04/180

| | | | | |
|----------------------|-----------------|----------|----------------|------------------|
| 1,5 | 0,0 | 6 | 25,40 | 1,000 |
| | -0,3 | 5 | 20,32 | 0,800 |
| 3,2 | 0,1 | 4 | 15,24 | 0,600 |
| | -0,3 | 3 | 10,16 | 0,400 |
| 4,5 | 0,1 | 2 | 5,08 | 0,200 |
| | -0,3 | | | |
| STIFTLAENGE L | TOLERANZ | n | L1 [mm] | L1 [Inch] |

| | | |
|----|--------|-------|
| 24 | 116,84 | 4,600 |
| 23 | 111,76 | 4,400 |
| 22 | 106,68 | 4,200 |
| 21 | 101,60 | 4,000 |
| 20 | 96,52 | 3,800 |
| 19 | 91,44 | 3,600 |
| 18 | 86,36 | 3,400 |
| 17 | 81,28 | 3,200 |
| 16 | 76,20 | 3,000 |
| 15 | 71,12 | 2,800 |
| 14 | 66,04 | 2,600 |
| 13 | 60,96 | 2,400 |
| 12 | 55,88 | 2,200 |
| 11 | 50,80 | 2,000 |
| 10 | 45,72 | 1,800 |
| 9 | 40,64 | 1,600 |
| 8 | 35,56 | 1,400 |
| 7 | 30,48 | 1,200 |

For the mounting of PCBs, it should be noted that the rated data relates only to the PCB components alone.
The necessary creepage and clearance paths must be observed in connection with the respective applicant in accordance to IEC 664 / VDE 0110.
The current-carrying capacity and pitch tolerance is to be determined according to DIN IEC 326 part 3 very fine.

Weidmüller PCB components are tested to the DIN EN 61984 standard, and are valid for its field of application. Provided that the components are used to the intended purpose, all requirements with respect to the occurring of electrical, mechanical, thermic and corrosive stress will be satisfied.

| | | | | | |
|----------|----------------|----------------------------------|-----------------------------|---|---|
| | DIN ISO 2768-m | 106339/4 30.07.18 HERTEL_S 00 | | Cat.no.: . | |
| | Modification | | | | C 34148 23 |
| | Drawn | 30.11.2007 | HELIS_MA | Drawing no. Issue no. | |
| | Responsible | | HERTEL_S | Sheet 01 of 04 sheets | |
| | Checked | 01.08.2018 | KOCH_JG | SL-SMT 5.08HC/.../180... STIFTLAENGE MALE HEADER | |
| Approved | | LANG_T | Product file: SL-SMT 5.08HC | | |

The reproduction, distribution and utilization of this document as well as the communication of its contents to others without explicit authorization is prohibited. Offenders will be held liable for the payment of damages. Weidmüller exclusively reserves the right to file for patents, utility models or designs.

Recommended wave soldering profiles

Weidmüller Interface GmbH & Co. KG
 Klingenbergstraße 16
 D-32758 Detmold
 Germany
 Fon: +49 5231 14-0
 Fax: +49 5231 14-292083
 www.weidmueller.com

Single Wave:

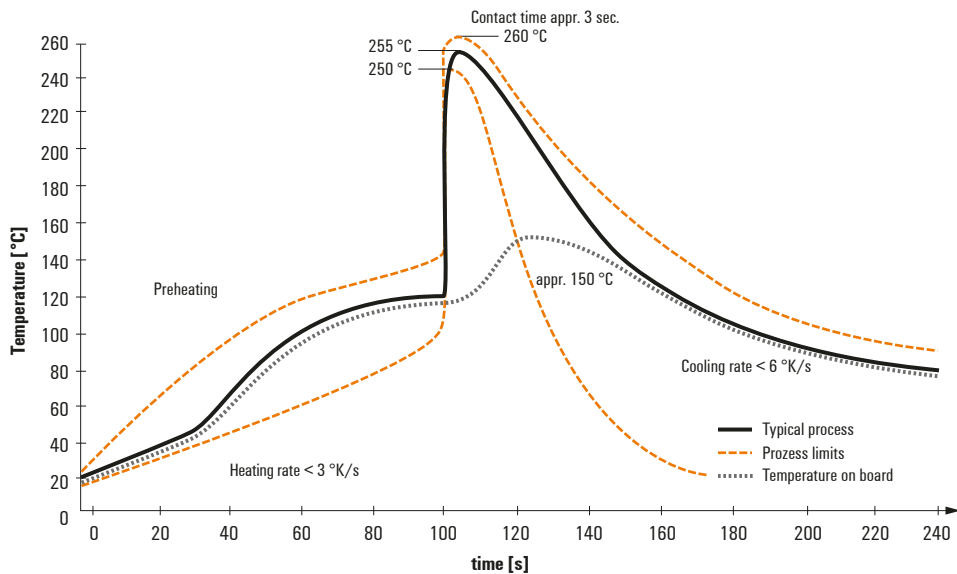

Double Wave:

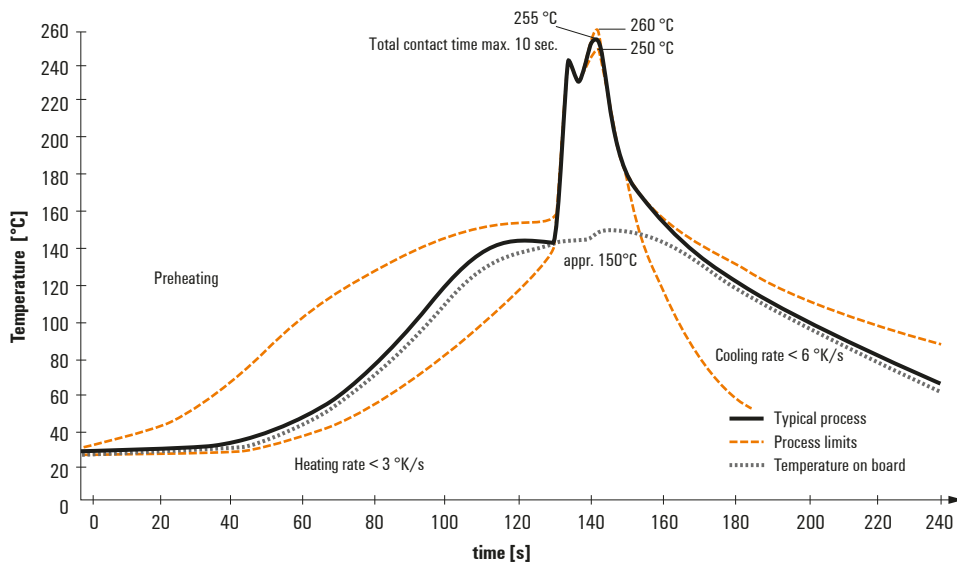

Wave soldering profiles

Wired connection elements should be processed in accordance with the DIN EN 61760-1 standard. We have included two recommendations for practical wave soldering profiles, with which Weidmüller PCB terminals and connectors are qualified.

When choosing a suitable profile for your application, the following factors also need to be considered:

- PCB thickness
- Proportion of Cu in the layers
- Single/double-sided assembly
- Product range
- Heating and cooling rates

The single and double wave profiles each indicate the recommended operating range, including the maximum soldering temperature of 260°C. In practice, the maximum soldering temperature is quite often well below the above maximum profile.

Recommended reflow soldering profile

Weidmüller Interface GmbH & Co. KG
 Klingenbergstraße 16
 D-32758 Detmold
 Germany
 Fon: +49 5231 14-0
 Fax: +49 5231 14-292083
 www.weidmueller.com

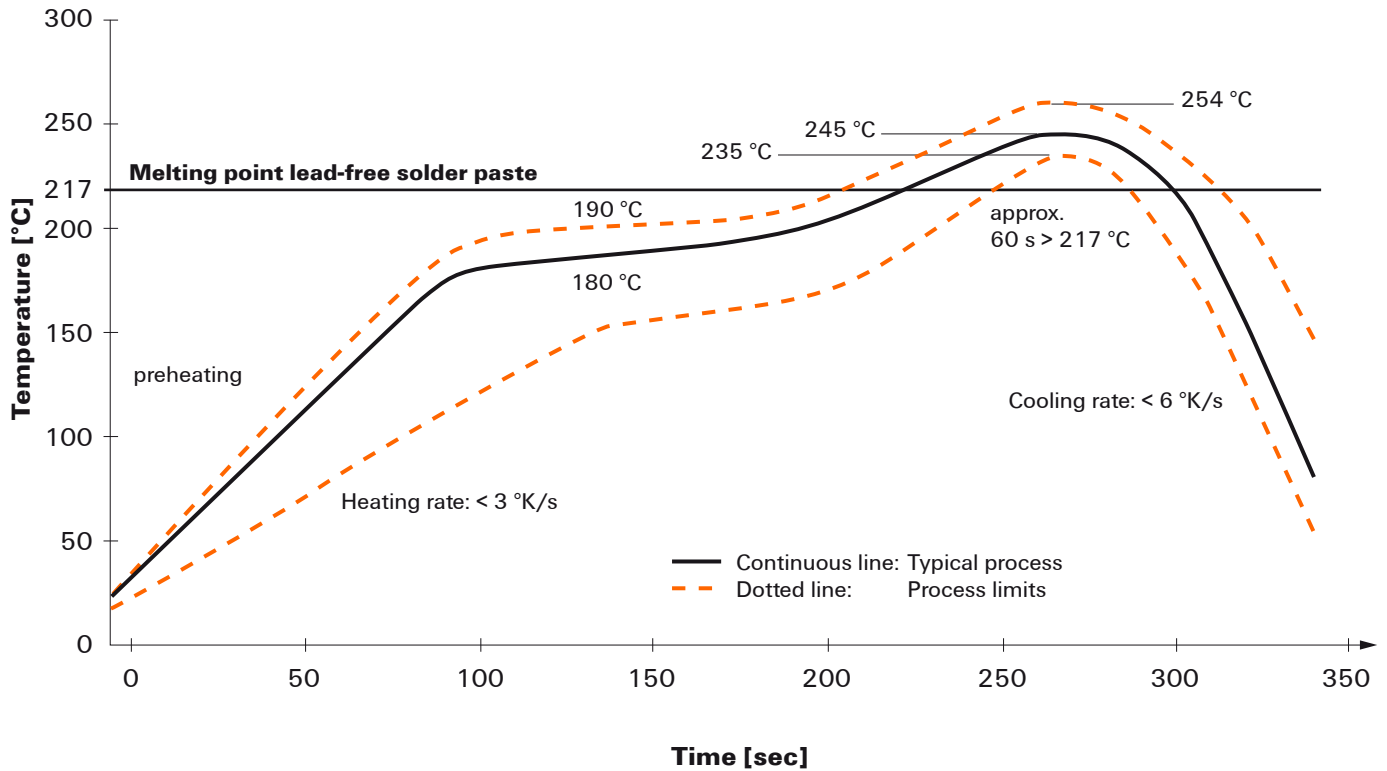

Reflow soldering profile

The perfect soldering profile for SMT Surface Mount Technology is one the most exiting question in SMT production. But there are more than one correct answer: The diagram of temperature-on-time is related to processing features of solder paste and to maximum load of components.

We have to consider the following parameters:

- Time for pre heating
- Maximum temperature
- Time above melting point
- Time for cooling
- Maximum heating rate
- Maximum cooling rate

We recommend a typical solder profile with associated process limits. With preheating components and board are prepared smoothly for the solder phase. Heating rate is typically $\leq +3\text{K/s}$. In parallel the solder paste is ‚activated‘. The time above melting point of 217°C the paste gets liquid and components and boards begin to connect. The maximum temperature of 245°C to 254°C should stay between 10 and 40 seconds. In the cooling phase at $\geq -6\text{K/s}$ solder is cured. Board and components cool down while avoiding cold cracks.