

Technical Summary

Second-Generation 32-Bit Enhanced Embedded Controller

The MC68EC030 is a 32-bit embedded controller that streamlines the functionality of an MC68030 for the requirements of embedded control applications. The MC68EC030 is optimized to maintain performance while using cost-effective memory subsystems. The rich instruction set and addressing mode capabilities of the MC68020, MC68030, and MC68040 have been maintained, allowing a clear migration path for M68000 systems. The main features of the MC68EC030 are as follows:

- Object-Code Compatible with the MC68020, MC68030, and Earlier M68000 Microprocessors
- Burst-Mode Bus Interface for Efficient DRAM Access
- On-Chip Data Cache (256 Bytes) and On-Chip Instruction Cache (256 Byte)
- Dynamic Bus Sizing for Direct Interface to 8-, 16-, and 32-Bit Devices
- 25- and 40-MHz Operating Frequency (up to 9.2 MIPS)
- Advanced Plastic Pin Grid Array Packaging for Through-Hole Applications

Additional features of the MC68EC030 include:

- Complete 32-Bit Nonmultiplexed Address and Data Buses
- Sixteen 32-Bit General-Purpose Data and Address Registers
- Two 32-Bit Supervisor Stack Pointers and Eight Special-Purpose Control Registers
- Two Access Control Registers Allow Blocks To Be Defined for Cacheability Protection
- Pipelined Architecture with Increased Parallelism Allows:
 - Internal Caches Accesses in Parallel with Bus Transfers
 - Overlapped Instruction Execution
- Enhanced Bus Controller Supports Asynchronous Bus Cycles (three clocks minimum), Synchronous Bus Cycle (two clocks minimum), and Burst Data Transfers (one clock)
- Complete Support for Coprocessors with the M68000 Coprocessor Interface
- Internal Status Indication for Hardware Emulation Support
- 4-Gbyte Direct Addressing Range
- Implemented in Motorola's HCMOS Technology That Allows CMOS and HMOS (High-Density NMOS) Gates To Be Combined for Maximum Speed, Low Power, and Small Die Size

This document contains information on a product under development. Motorola reserves the right to change or discontinue this product without notice.

INTRODUCTION

The MC68EC030 is an integrated controller that incorporates the capabilities of the MC68030 integer unit, a data cache, an instruction cache, an access control unit (ACU), and an improved bus controller on one VLSI device. It maintains the 32-bit registers available with the entire M68000 Family as well as the 32-bit address and data paths, rich instruction set, versatile addressing modes, and flexible coprocessor interface provided with the MC68020 and MC68030. In addition, the internal operations of this integrated controller are designed to operate in parallel, allowing instruction execution to proceed in parallel with accesses to the internal caches and the bus controller.

The MC68EC030 fully supports the nonmultiplexed asynchronous bus of the MC68020 and MC68030 as well as the dynamic bus sizing mechanism that allows the controller to transfer operands to or from external devices while automatically determining device port size on a cycle-by-cycle basis. In addition to the asynchronous bus, the MC68EC030 also supports the fast synchronous bus of the MC68030 for off-chip caches and fast memories. Like the MC68030, the MC68EC030 bus is capable of fetching up to four long words of data in a burst mode compatible with DRAM chips that have burst capability. Burst mode can reduce (up to 50 percent) the time necessary to fetch the four long words. The four long words are used to prefill the on-chip instruction and data caches so that the hit ratio of the caches is improved and the average access time for operand fetches is minimized.

The MC68EC030 is specifically designed to sustain high performance while using low-cost (DRAM) memory subsystems. Coupled with the MC88916 clock generation and distribution circuit, the MC68EC030 provides simple interface to lower speed memory subsystems. The MC88916 (see Figure 1) provides the precise clock signals required to efficiently control memory subsystems, eliminating system design constraints due to clock generation and distribution.

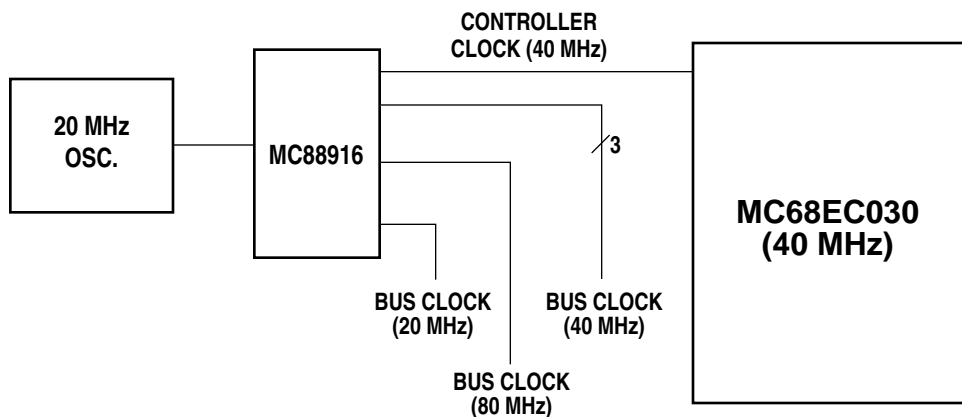

Figure 1. MC68EC030 Clock Circuitry

The block diagram shown in Figure 2 depicts the major sections of the MC68EC030 and illustrates the autonomous nature of these blocks. The bus controller consists of the address and data pads, the multiplexers required to support dynamic bus sizing, and a microbus controller that schedules the bus cycles on the basis of priority. The micromachine contains the execution unit and all related control logic. Microcode control is provided by a modified two-level store of microROM and nanoROM contained in the micromachine. Programmed logic arrays (PLAs) are used to provide instruction decode and sequencing

information. The instruction pipe and other individual control sections provide the secondary decode of instructions and generate the actual control signals that result in the decoding and interpretation of nanoROM and microROM information.

The instruction and data cache blocks operate independently from the rest of the machine, storing information read by the bus controller for future use with very fast access time. Each cache resides on its own address bus and data bus, allowing simultaneous access to both. The data and instruction caches are organized as a total of 64 long-word entries (256 bytes) with a line size of four long words. The data cache uses a write-through policy with programmable write allocation for cache misses.

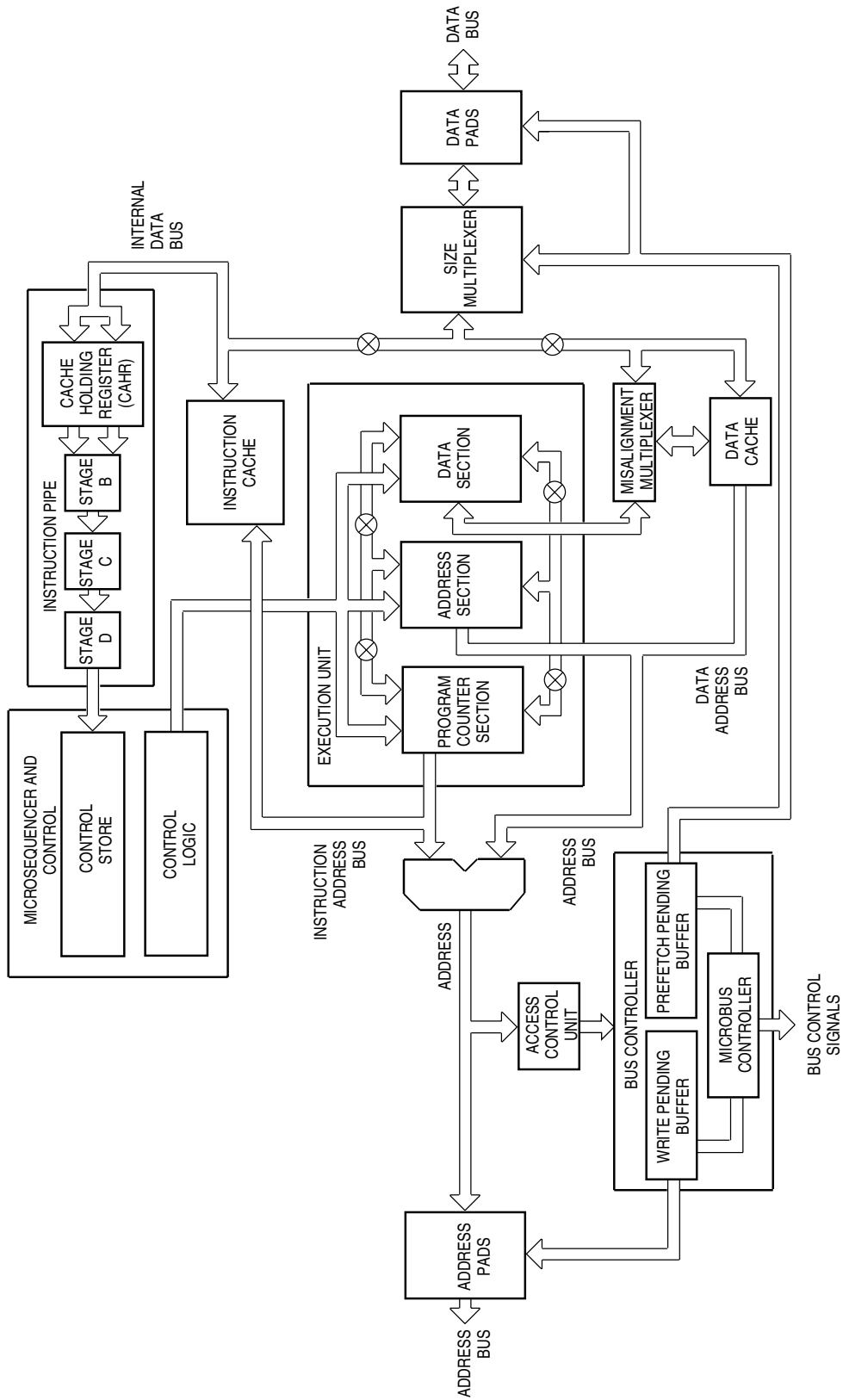

Figure 2. Block Diagram

The ACU contains two access control registers that are used to define memory segments ranging in size from 16 Mbytes to 2 Gbytes each. Each segment is definable in terms of address, read/write access, and function code. Each segment can be marked as cacheable or non cacheable to control cache accesses to that memory space.

PROGRAMMING MODEL

As shown in the programming models (see Figures 3 and 4), the MC68EC030 has 16 32-bit general-purpose registers, a 32-bit program counter, two 32-bit supervisor stack pointers, a 16-bit status register, a 32-bit vector base register, two 3-bit alternate function code registers, two 32-bit cache handling (address and control) registers, and two 32-bit transparent translation registers. Registers D0–D7 are used as data registers for bit and bit field (1 to 32 bit), byte (8 bit), word (16 bit), long-word (32 bit), and quad-word (64 bit) operations. Registers A0–A6 and the user, interrupt, and master stack pointers are address registers that may be used as software stack pointers or base address registers. In addition, the address registers may be used for word and long-word operations. All 16 general-purpose registers (D0–D7, A0–A7) can be used as index registers.

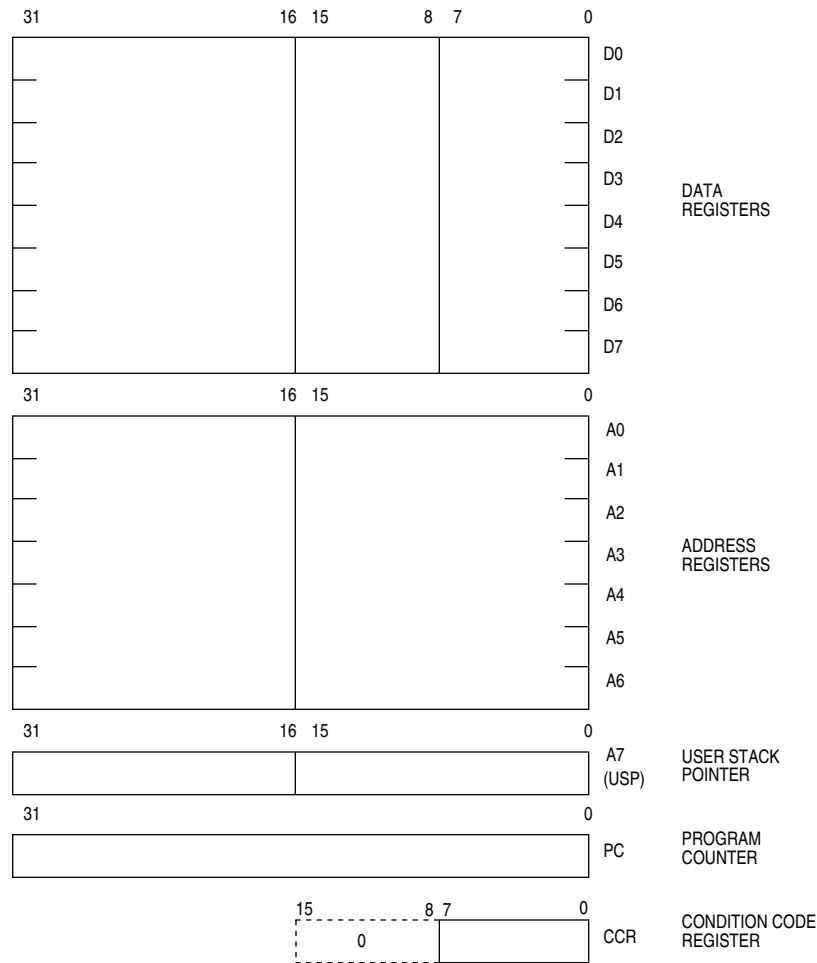

Figure 3. User Programming Model

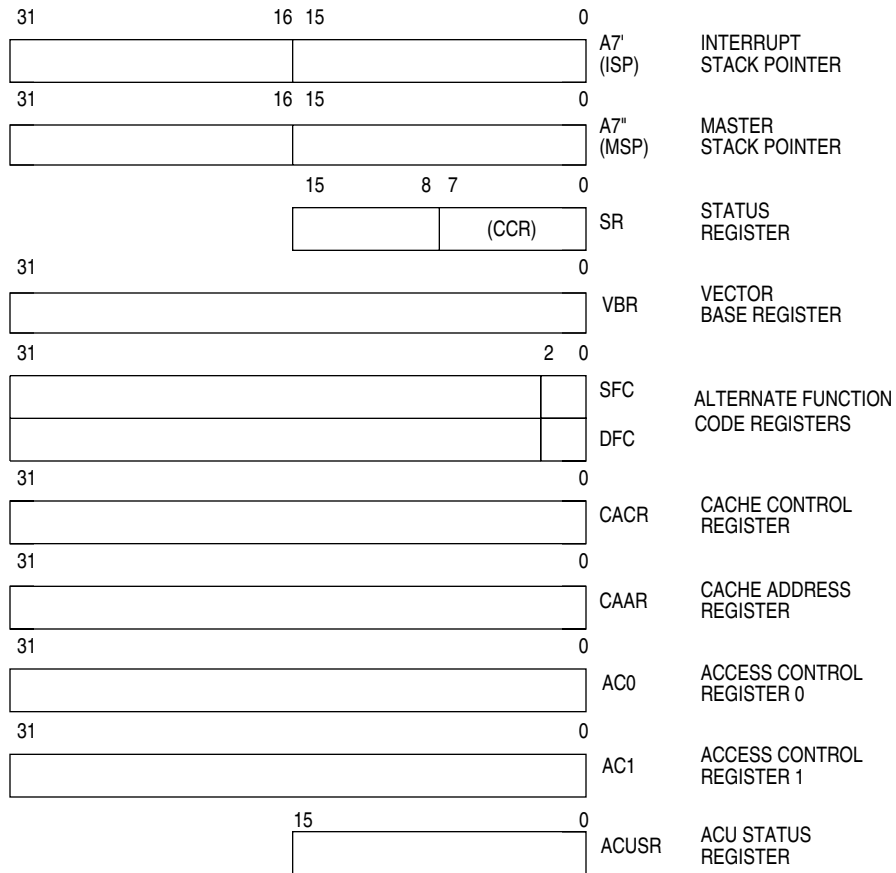

Figure 4. Supervisor Programming Model Supplement

The status register (see Figure 5) contains the interrupt priority mask (three bits) as well as the following condition codes: extend (X), negate (N), zero (Z), overflow (V), and carry (C). Additional control bits indicate that the controller is in the trace mode (T1 or T0), supervisor/user state (S), and master/interrupt state (M).

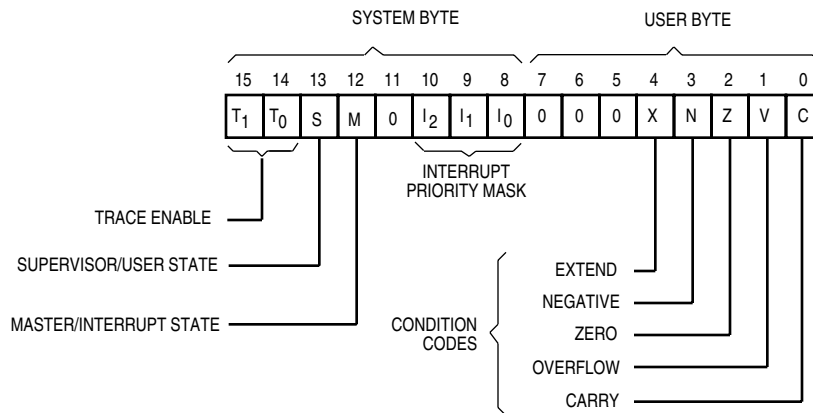

Figure 5. Status Register

All microprocessors of the M68000 Family support instruction tracing (via the T0 status bit in the MC68EC030) where each instruction executed is followed by a trap to a user-defined trace routine. The MC68EC030, like the MC68030 and MC68040, also has the capability to trace only on change-of-flow instructions (branch, jump, subroutine call and return, etc.) using the T1 status bit. These features are important for software program development and debug.

The vector base register (VBR) is used to determine the run-time location of the exception vector table in memory; thus, each separate vector table for each process or task can properly manage exceptions independent of each other.

The M68000 Family processors distinguish address spaces as supervisor/user, program/data, and CPU space. These five combinations are specified by the function code pins (FC0/FC1/FC2) during bus cycles, indicating the particular address space. Using the function codes, the memory subsystem (hardware) can distinguish between supervisor accesses and user accesses as well as program accesses, data accesses, and CPU space accesses. To support the full privileges of the supervisor, the alternate function code registers allow the supervisor to specify the function code for an access by appropriately preloading the SFC/DFC registers.

The cache registers allow supervisor software manipulation of the on-chip instruction and data caches. Control and status accesses to the caches are provided by the cache control register (CACR); the cache address register (CAAR) specifies the address for those cache control functions that require an address.

The access control registers are accessible by the supervisor only. The access control registers are used to define two memory spaces with caching restrictions. The ACU status register (ACUSR) is used to show the result of PTEST operations on the ACU.

DATA TYPES AND ADDRESSING MODES

Seven basic data types are supported by the MC68EC030:

- Bits
- Bit Fields (String of consecutive bits, 1–32 bits long)
- BCD Digits (Packed: 2 digits/byte, Unpacked: 1 digit/byte)
- Byte Integers (8 bits)
- Word Integers (16 bits)
- Long-Word Integers (32 bits)
- Quad-Word Integers (64 bits)

In addition, operations on other data types, such as memory addresses, status word data, etc., are provided in the instruction set. The coprocessor mechanism allows direct support of floating-point data types with the MC68881/MC68882 floating-point coprocessors as well as specialized user-defined data types and functions. The 18 addressing modes, listed in Table 1, include nine basic types:

- Register Direct
- Register Indirect
- Register Indirect with Index
- Memory Indirect
- Program Counter Indirect with Displacement
- Program Counter Indirect with Index
- Program Counter Memory Indirect
- Absolute
- Immediate

The register indirect addressing modes support postincrement, predecrement, offset, and indexing. These capabilities are particularly useful for handling advanced data structures common to sophisticated applications and high-level languages. The program counter relative mode also has index and offset capabilities; this addressing mode is generally required to support position-independent software. In addition to these addressing modes, the MC68EC030 provides data operand sizing and scaling; these features provide performance enhancements to the programmer.

Table 1. MC68EC030 Addressing Modes

| Addressing Modes | Syntax |
|--|--------------------------------------|
| Register Direct Addressing Data Register Direct Address Register Direct | Dn An |
| Register Indirect Address Register Indirect Address Register Indirect with Postincrement Address Register Indirect with Predecrement Address Register Indirect with Displacement | (An) (An);pl -(An) (d16,An) |
| Register Indirect with Index Address Register Indirect with Index (8-Bit Displacement) Address Register Indirect with Index (Base Displacement) | (d8,An,Xn) (bd,An,Xn) |
| Memory Indirect Memory Indirect Postindexed Memory Indirect Preindexed | ([bd,An],Xn,od) ([bd,An,Xn],od) |
| Program Counter Indirect with Displacement | (d16,PC) |
| Program Counter Indirect with Index PC Indirect with Index (8-Bit Displacement) PC Indirect with Index (Base Displacement) | (d8,PC,Xn) (bd,PC,Xn) |
| Program Counter Memory Indirect PC Memory Indirect Postindexed PC Memory Indirect Preindexed | ([bd,PC],Xn,od) ([bd,PC,Xn],od) |
| Absolute Data Addressing Absolute Short Absolute Long | xxx.W xxx.L |
| Immediate | #<data> |

NOTES:

- Dn = Data Register, D0–D7
- An = Address Register, A0–A7
- d8, d16 = A two's-complement or sign-extended displacement; added as part of the effective address calculation; size is 8 (d8) or 16 (d16) bits; when omitted, assemblers use a value of zero.
- Xn = Address or data register used as an index register; form is Xn.SIZE*SCALE, where SIZE is .W or .L (indicates index register size) and SCALE is 1, 2, 4, or 8 (index register is multiplied by SCALE); use of SIZE and/or SCALE is optional.
- bd = A two's-complement base displacement; when present, size can be 16 or 32 bits.
- od = Outer displacement added as part of effective address calculation after any memory indirection; use is optional with a size of 16 or 32 bits.
- PC = Program Counter
- <data> = Immediate value of 8, 16, or 32 bits
- () = Effective Address
- [] = Used as indirect address to long-word address.

INSTRUCTION SET OVERVIEW

The MC68EC030 instruction set is listed in Table 2. Each instruction, with few exceptions, operates on bytes, words, and long words, and most instructions can use any of the 18 addressing modes. The MC68EC030 is upward source- and object-level code compatible with the M68000 Family because it supports all instructions of previous family members.

Table 2. Instruction Set

| Mnemonic | Description | Mnemonic | Description |
|-------------|---|------------|-----------------------------------|
| ABCD | Add Decimal with Extend | MOVE | Move |
| ADD | Add | MOVEA | Move Address |
| ADDA | Add Address | MOVE CCR | Move Condition Code Register |
| ADDI | Add Immediate | MOVE SR | Move Status Register |
| ADDQ | Add Quick | MOVE USP | Move User Stack Pointer |
| ADDX | Add with Extend | MOVEC | Move Control Register |
| AND | Logical AND | MOVEM | Move Multiple Registers |
| ANDI | Logical AND Immediate | MOVEP | Move Peripheral |
| ASL,ASR | Arithmetic Shift Left and Right | MOVEQ | Move Quick |
| Bcc | Branch Conditionally | MOVES | Move Alternate Address Space |
| BCHG | Test Bit and Change | MULS | Signed Multiply |
| BCLR | Test Bit and Clear | MULU | Unsigned Multiply |
| BFCHG | Test Bit Field and Change | NBCD | Negate Decimal with Extend |
| BFCLR | Test Bit Field and Clear | NEG | Negate |
| BFEXTS | Signed Bit Field Extract | NEGX | Negate with Extend |
| BEFXTU | Unsigned Bit Field Extract | NOP | No Operation |
| BFFFO | Bit Field Find First One | NOT | Logical Complement |
| BFINS | Bit Field Insert | OR | Logical Inclusive OR |
| BFSET | Test Bit Field and Set | ORI | Logical Inclusive OR Immediate |
| BFTST | Test Bit Field | PACK | Pack BCD |
| BKPT | Breakpoint | PEA | Push Effective Address |
| BRA | Branch | PFLUSH | No Effect |
| BSET | Test Bit and Set | PLOAD | No Effect |
| BSR | Branch to Subroutine | PMOVE | Move to/from ACx Registers |
| BTST | Test Bit | PTEST | Test Address in ACx Registers |
| CAS | Compare and Swap Operands | RESET | Reset External Devices |
| CAS2 | Compare and Swap Dual Operands | ROL, ROR | Rotate Left and Right |
| CHK | Check Register Against Bound | ROXL, ROXR | Rotate with Extend Left and Right |
| CHK2 | Check Register Against Upper and Lower Bounds | RTD | Return and Deallocate |
| CLR | Clear | RTE | Return from Exception |
| CMP | Compare | RTR | Return and Restore Codes |
| CMPA | Compare Address | RTS | Return from Subroutine |
| CMPI | Compare Immediate | SBCD | Subtract Decimal with Extend |
| CMPM | Compare Memory to Memory | Scc | Set Conditionally |
| CMP2 | Compare Register Against Upper and Lower Bounds | STOP | Stop |
| DBcc | Test Condition, Decrement and Branch | SUB | Subtract |
| DIVS, DIVSL | Signed Divide | SUBA | Subtract Address |
| DIVU, DIVUL | Unsigned Divide | SUBI | Subtract Immediate |
| EOR | Logical Exclusive OR | SUBQ | Subtract Quick |
| EORI | Logical Exclusive OR Immediate | SUBX | Subtract with Extend |
| EXG | Exchange Registers | SWAP | Swap Register Words |
| EXT, EXTB | Sign Extend | TAS | Test Operand and Set |
| ILLEGAL | Take Illegal Instruction Trap | TRAP | Trap |
| JMP | Jump | TRAPcc | Trap Conditionally |
| JSR | Jump to Subroutine | TRAPV | Trap on Overflow |
| LEA | Load Effective Address | TST | Test Operand |
| LINK | Link and Allocate | UNLK | Unlink |
| LSL, LSR | Logical Shift Left and Right | UNPK | Unpack BCD |

Coprocessor Instructions

| | | | |
|--------|---|-----------|---------------------------------------|
| cpBCC | Branch Conditionally | cpRESTORE | Restore Internal State of Coprocessor |
| cpDBcc | Test Coprocessor Condition, Decrement and Branch | cpSAVE | Save Internal State of Coprocessor |
| cpGEN | Coprocessor General Instruction | cpScc | Set Conditionally |
| | | cpTRAPcc | Trap Conditionally |

Included in the MC68EC030 set are the bit field operations, binary-coded decimal support, bounds checking, additional trap conditions, and additional multiprocessing support (CAS and CAS2 instructions) offered by the MC68020, MC68030, and MC68040. In addition, object code written for the MC68EC030 can be used on the MC68040 for even more performance. The memory management unit (MMU) instructions of the MC68030, and MC68040 are not supported by the MC68EC030.

INSTRUCTION AND DATA CACHES

Studies have shown that typical programs spend most of their execution time in a few main routines or tight loops. This phenomenon, known as locality of reference, has an impact on program performance. The MC68010 takes limited advantage of this phenomenon with the loop mode of operation that can be used with the DBcc instruction. The MC68EC030 takes further advantage of cache technology to provide the system with two on-chip caches, one for instructions and one for data.

MC68EC030 CACHE GOALS

Similar to the MC68020 and MC68030, there were two primary design goals for the MC68EC030 embedded controller caches. The first design goal was to reduce the external bus activity of the CPU even more than was accomplished with the MC68020. The second design goal was to increase effective CPU throughput as larger memory sizes or slower memories increased average access time. By placing a high-speed cache between the controller and the rest of the memory system, the effective memory access time becomes:

$$t_{acc} = R_h * t_{cache} + (1 - R_h) * t_{ext}$$

where t_{acc} is the effective system access time, t_{cache} is the cache access time, t_{ext} is the access time of the rest of the system, and R_h is the hit ratio or the percentage of time that the data is found in the cache. Thus, for a given system design, the two MC68EC030 on-chip caches provide an even more substantial CPU performance increase over that obtainable with the MC68020 instruction cache. Alternately, slower and less expensive memories can be used for the same controller performance.

The throughput increase in the MC68EC030 is gained in three ways. First, the MC68EC030 caches are accessed in less time than is required for external accesses, providing improvement in the access time for items residing in the cache. Second, the burst filling of the caches allows instruction and data words to be found in the on-chip caches the first time they are accessed by the micromachine, minimizing the time required to bring those items into the cache. Utilizing burst fill capabilities lowers the average access time for items found in the caches even further. Third, the autonomous nature of the caches allows instruction stream fetches, data fetches, and external bus activity to occur simultaneously with instruction execution. The parallelism designed into the MC68EC030 also allows multiple instructions to execute concurrently so that several internal instructions (those that do not require any external accesses) can execute while the controller is performing an external access for a previous instruction.

INSTRUCTION CACHE

The MC68EC030 instruction cache is a 256-byte direct-mapped cache organized as 16 lines consisting of four long words per line. Each long word is independently accessible, yielding 64 possible entries, with address bit A1 selecting the correct word during an access. Thus, each line has a tag field composed of the upper 24 address bits, the FC2 (supervisor/user) value, four valid bits (one for each long-word entry), and the four long-word entries (see Figure 6). The instruction cache is automatically filled by the MC68EC030 whenever a cache miss occurs; using the burst transfer capability, up to four long words can be filled in one burst operation. The caches cannot be manipulated directly by the programmer except by the use of the CACR, which provides cache clearing and cache entry clearing facilities. The caches can also be enabled/disabled by this register. Finally, the system hardware can disable the on-chip caches at any time by asserting the CDIS signal.

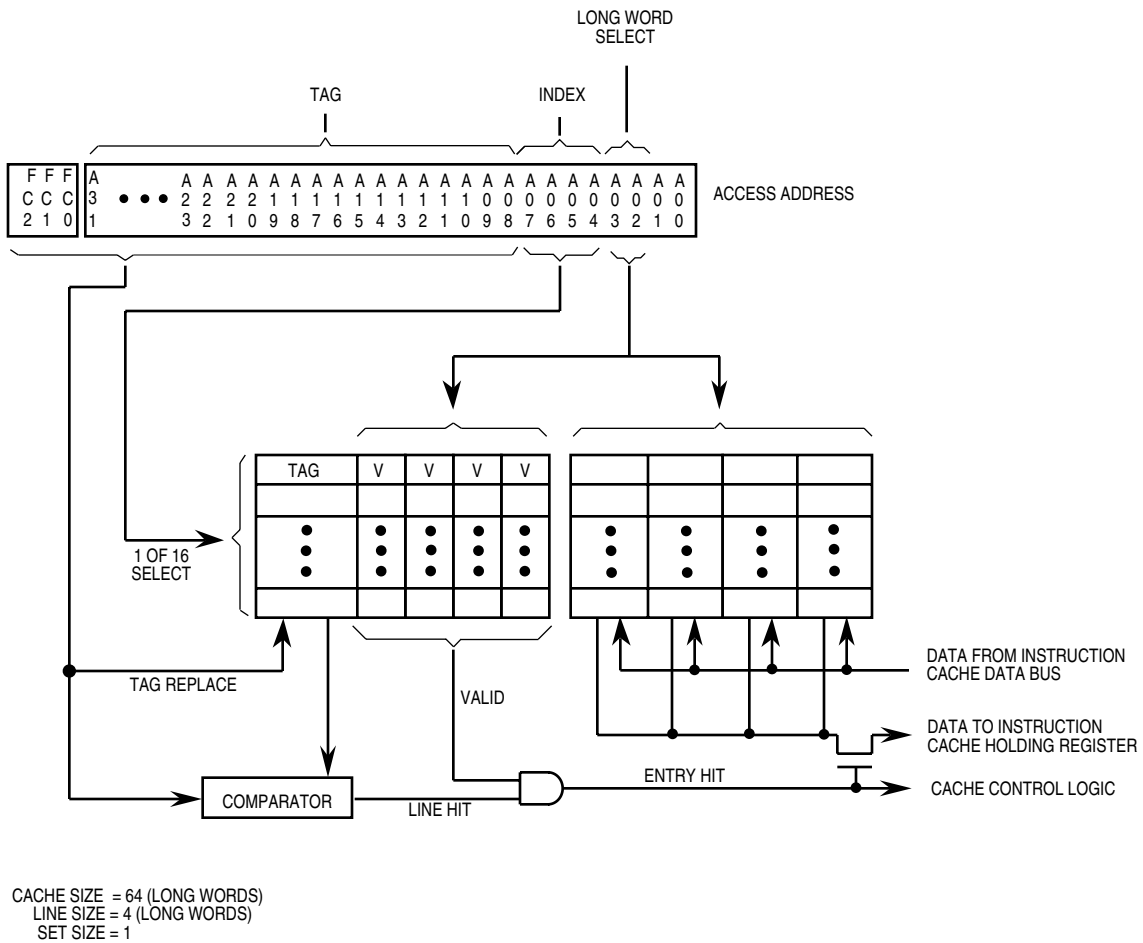

Figure 6. On-Chip Instruction Cache Organization

DATA CACHE

The organization of the data cache (see Figure 7) is similar to that of the instruction cache. However, the tag is composed of the upper 24 address bits, the four valid bits, and all three function code bits, explicitly specifying the address space associated with each line. The data cache employs a write-through policy with programmable write allocation of data writes— i.e., if a cache hit occurs on a write cycle, both the data cache and the external device are updated with the new data. If a write cycle generates a cache miss, the external device is updated, and a new data cache entry can be replaced or allocated for that address, depending on the state of the write-allocate (WA) bit in the CACR.

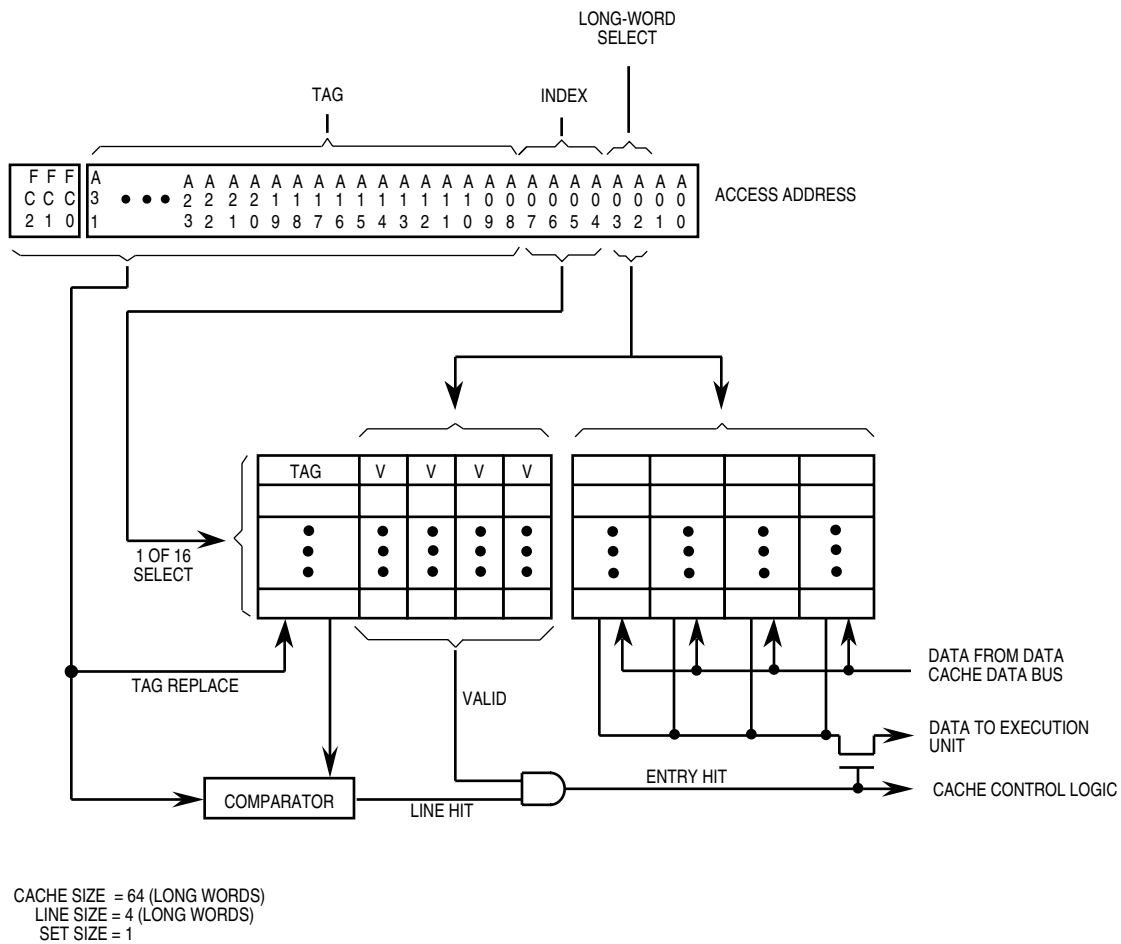

Figure 7. On-Chip Data Cache Organization

OPERAND TRANSFER MECHANISM

The MC68EC030 offers three different mechanisms by which data can be transferred into and out of the chip. Asynchronous bus cycles, compatible with the asynchronous bus on the MC68020 and MC68030, can transfer data in a minimum of three clock cycles; the amount of data transferred on each cycle is determined by the dynamic bus sizing mechanism on a cycle-by-cycle basis with the data transfer and size acknowledge (DSACKx) signals. Synchronous bus cycles, compatible with the synchronous bus on the MC68030, are terminated with the synchronous termination (STERM) signal and always transfer 32-bits of data in a minimum of two clock cycles, increasing the bus bandwidth available for other bus masters,

thereby increasing possible performance. Burst mode transfers can be used to fill lines of the instruction and data caches when the MC68EC030 asserts cache burst request (CBREQ). After completing the first cycle with STERM, subsequent cycles may accept data on every clock cycle where STERM is asserted until the burst is completed. Use of this mode can further increase the available bus bandwidth in systems that use DRAMs with page, nibble, or static-column mode operation.

ASYNCHRONOUS TRANSFERS

Though the MC68EC030 has a full 32-bit data bus, it offers the ability to automatically and dynamically downsize its bus to 8 or 16 bits if peripheral devices are unable to accommodate the entire 32 bits. This feature allows the programmer to write code that is not bus-width specific. For example, long-word (32 bit) accesses to peripherals may be used in the code; yet, the MC68EC030 will transfer only the amount of data that the peripheral can manage. This feature allows the peripheral to define its port size as 8, 16, or 32 bits wide, and the MC68EC030 will dynamically size the data transfer accordingly, using multiple bus cycles when necessary. Hence, programmers are not required to program for each device port size or know the specific port size before coding; hardware designers have the flexibility to choose hardware implementations regardless of software implementations.

The dynamic bus sizing mechanism is invoked by DSACK_x and occurs on a cycle-by-cycle basis. For example, if the controller is executing an instruction that requires reading a long-word operand, it will attempt to read 32 bits during the first bus cycle to a long-word address boundary. If the port responds that it is 32 bits wide, the MC68EC030 latches all 32 bits of data and continues. If the port responds that it is 16 bits wide, the MC68EC030 latches the 16 valid bits of data and continues. An 8-bit port is handled similarly but has four bus read cycles. Each port is fixed in the assignment to particular sections of the data bus. However, the MC68EC030 has no restrictions concerning the alignment of operands in memory; long-word operands need not be aligned to long-word address boundaries. When misaligned data requires multiple bus cycles, the MC68EC030 automatically runs the minimum number of bus cycles. Instructions must still be aligned to word boundaries.

The timing of asynchronous bus cycles is also determined by the assertion of DSACK_x on a cycle-by-cycle basis. If the DSACK_x signals are valid 1.5 clocks after the beginning of the bus cycle (with the appropriate setup time), the cycle terminates in the minimum amount of time (corresponding to three-clock-cycle total). The cycle can be lengthened by delaying DSACK_x (effectively inserting wait states in one-clock increments) until the device being accessed is able to terminate the cycle. This flexibility gives the controller the ability to communicate with devices of varying speeds while operating at the fastest rate possible for each device.

The asynchronous transfer mechanism allows external errors to abort cycles upon the assertion of bus error (BERR) or allows individual bus cycles to be retried with the simultaneous assertion of BERR and HALT.

SYNCHRONOUS TRANSFERS

Synchronous bus cycles are terminated by asserting *STERM*, which automatically indicates that the bus transfer is for 32 bits. Since this input is not synchronized internally, two-clock-cycle bus accesses can be performed if the signal is valid one clock after the beginning of the bus cycle with the appropriate setup time. However, the bus cycle may be lengthened by delaying *STERM* (inserting wait states in one-clock increments) until the device being accessed is able to terminate the cycle. After the assertion of *STERM*, these cycles may be aborted upon the assertion of *BERR*, or they may be retried with the simultaneous assertion of *BERR* and *HALT*.

BURST READ CYCLES

The MC68EC030 provides support for burst filling of its on-chip instruction and data caches, adding to the overall system performance. The on-chip caches are organized with a line size of four long words; there is only one tag for the four long words in a line. Since locality of reference is present to some degree in most programs, filling of all four entries when a single entry misses can be advantageous, especially if the time spent filling the additional entries is minimal. When the caches are burst filled, data can be latched by the controller in as little as one clock for each 32 bits. Burst read cycles can be performed only when the MC68EC030 requests them (with the assertion of *CBREQ*) and only when the first cycle is a synchronous cycle as previously described. If the cache burst acknowledge (*CBACK*) input is valid at the appropriate time in the synchronous bus cycle, the controller keeps the original *AS*, *DS*, *R/W*, address, function code, and size outputs asserted and latches 32 bits from the data bus at the end of each subsequent clock cycle that has *STERM* asserted. This procedure continues until the burst is complete (the entire block has been transferred), *BERR* is asserted in lieu of or after *STERM*, the cache inhibit in (*CIIN*) input is asserted, or the *CBACK* input is negated. The cache preloading allowed by the bursting enables the MC68EC030 to take advantage of cost-effective DRAM technology with minimal performance impact.

EXCEPTIONS

The types of exceptions and the exception processing sequence are discussed in the following paragraphs.

TYPES OF EXCEPTIONS

Exceptions can be generated by either internal or external causes. The externally generated exceptions are interrupts, *BERR*, and *RESET*. Interrupts are requests from peripheral devices for controller action; whereas, *BERR* and *RESET* are used for access control and controller restart. The internally generated exceptions come from instructions, address errors, tracing, or breakpoints. The *TRAP*, *TRAPcc*, *TRAPVcc*, *cpTRAPcc*, *CKH*, *CKH2*, and *DIV* instructions can all generate exceptions as part of instruction execution. Tracing behaves like a very high-priority, internally generated interrupt whenever it is processed. The other internally generated exceptions are caused by illegal instructions, instruction fetches from odd addresses, and privilege violations.

EXCEPTION PROCESSING SEQUENCE

Exception processing occurs in four steps. During the first step, an internal copy is made of the status register. After the copy is made, the special controller state bits in the status register are changed. The S-bit is set, putting the controller into the supervisor state. Also, the T1 and T0 bits are negated, allowing the exception handler to execute unhindered by tracing. For the reset and interrupt exceptions, the interrupt priority mask is also updated.

In the second step, the vector number of the exception is determined. For interrupts, the vector number is obtained by a controller read that is classified as an interrupt acknowledge cycle. For coprocessor-detected exceptions, the vector number is included in the coprocessor exception primitive response. For all other exceptions, internal logic provides the vector number. This vector number is then used to generate the address of the exception vector.

The third step is to save the current controller status. The exception stack frame is created and filled on the current supervisor stack. To minimize the amount of machine state that is saved, various stack frame sizes are used to contain the controller state, depending on the type of exception and where it occurred during instruction execution. If the exception is an interrupt and the M-bit is set, the M-bit is then cleared, and the short four-word exception stack frame that is saved on the master stack is also saved on the interrupt stack. If the exception is a reset, the M-bit is simply cleared, and the reset vector is accessed.

The MC68EC030 provides the same extensions to the exception stacking process as the MC68020, MC68030, and MC68040. If the M-bit is set, the master stack pointer (MSP) is used for all task-related exceptions. When a nontask-related exception occurs (i.e., an interrupt), the M bit is cleared, and the interrupt stack pointer (ISP) is used. This feature allows all the task's stack area to be carried within a single controller control block, and new tasks can be initiated by simply reloading the MSP and setting the M-bit.

The fourth and last step of exception processing is the same for all exceptions. The exception vector offset is determined by multiplying the vector number by four. This offset is then added to the contents of the vector base register (VBR) to determine the memory address of the exception vector. The new program counter is fetched from the exception vector. The instruction at the address given in the exception vector is fetched, and normal instruction decoding and execution is started.

STATUS and REFILL

The MC68EC030 provides the STATUS and REFILL signals to identify internal microsequencer activity associated with the processing of data pipelined in the pipeline. Since bus cycles are independently controlled and scheduled by the bus controller, information concerning the processing state of the microsequencer is not available by monitoring bus signals by themselves. The internal activity identified by the STATUS and REFILL signals include instruction boundaries, some exception conditions, when the microsequencer has halted, and instruction pipeline refills. STATUS and REFILL track only the internal microsequencer activity and are not directly related to bus activity.

ACCESS CONTROL

Two access control registers are provided on the MC68EC030 to control cachability of accesses for two independent blocks of memory. Each block can range in size from 16 Mbytes to 2 Gbytes, and is specified in the corresponding ACx register with a base address, a base mask, function code, function code mask, and read/write mask. A typical use for an access control register is to designate a block of memory containing I/O devices as non-cachable.

COPROCESSOR INTERFACE

The coprocessor interface is a mechanism for extending the instruction set of the M68000 Family. The interface provided on the MC68EC030 is the same as that on the MC68020 and MC68030. Examples of these extensions are the addition of specialized data operands for the existing data types or, for the case of floating point, the inclusion of new data types and operations implemented by the MC68881/MC68882 floating-point coprocessors.

SIGNAL DESCRIPTION

Figure 8 illustrates the functional signal groups, and Table 3 describe the signals and their function.

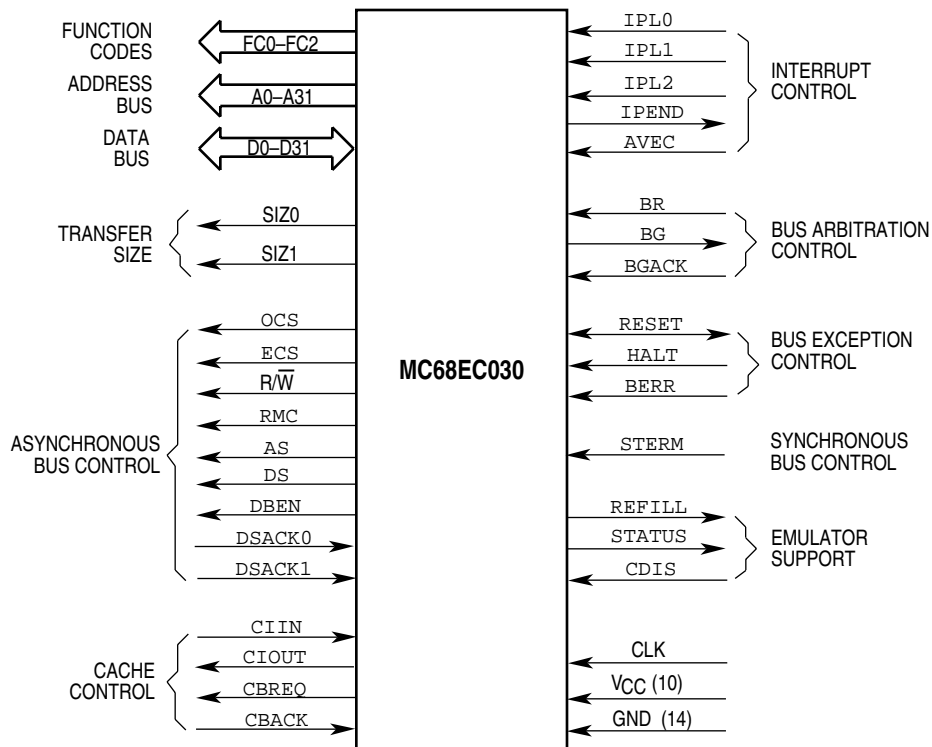

Figure 8. Functional Signal Groups

Table 3. Signal Index

| Signal Name | Mnemonic | Function |
|------------------------------------|-----------------|--|
| Function Codes | FC0–FC2 | 3-bit function code used to identify the address space of each bus cycle. |
| Address Bus | A0–A31 | 32-bit address bus. |
| Data Bus | D0–D31 | 32-bit data bus used to transfer 8, 16, 24, or 32 bits of data per bus cycle. |
| Size | SIZ0–SIZ1 | Indicates the number of bytes remaining to be transferred for this cycle. These signals, together with A0 and A1, define the active sections of the data bus. |
| Operand Cycle Start | OCS | Identical operation to that of ECS except that OCS is asserted only during the first bus cycle of an operand transfer |
| External Cycle Start | ECS | Provides an indication that a bus cycle is beginning. |
| Read/Write | R/W | Defines the bus transfer as a controller read or write. |
| Read-Modify-Write Cycle | RMC | Provides an indicator that the current bus cycle is part of an indivisible read-modify-write operation. |
| Address Strobe | AS | Indicates that a valid address is on the bus. |
| Data Strobe | DS | Indicates that valid data is to be placed on the data bus by an external device or has been replaced by the MC68EC030. |
| Data Buffer Enable | DBEN | Provides an enable signal for external data buffers. |
| Data Transfer and Size Acknowledge | DSACK0, DSACK1 | Bus response signals that indicate the requested data transfer operation has completed. In addition, these two lines indicate the size of the external bus port on a cycle-by-cycle basis and are used for asynchronous transfers. |
| Synchronous Termination | STERM | Bus response signal that indicates a port size of 32 bits and that data may be latched on the next falling clock edge. |
| Cache Inhibit In | CIIN | Prevents data from being loaded into the MC68EC030 instruction and data caches. |
| Cache Inhibit Out | CIOUT | Reflects the CI bit in ACx registers; indicates that external caches should ignore these accesses. |
| Cache Burst Request | CBREQ | Indicates a burst request for the instruction or data cache. |
| Cache Burst Acknowledge | CBACK | Indicates that the accessed device can operate in burst mode. |
| Interrupt Priority Level | IPL0–IPL2 | Provides an encoded interrupt level to the controller. |
| Interrupt Pending | IPEND | Indicates that an interrupt is pending. |
| Autovector | AVEC | Requests an autovector during an interrupt acknowledge cycle. |
| Bus Request | BR | Indicates that an external device requires bus mastership. |
| Bus Grant | BG | Indicates that an external device may assume bus mastership. |
| Bus Grant Acknowledge | BGACK | Indicates that an external device has assumed bus mastership. |
| Reset | RESET | System reset. |
| Halt | HALT | Indicates that the controller should suspended bus activity. |
| Bus Error | BERR | Indicates that an erroneous bus operation is being attempted. |
| Cache Disable | CDIS | Dynamically disables the on-chip cache to assist emulator support. |
| Pipe Refill | REFILL | Indicates when the MC68EC030 is beginning to fill pipeline. |
| Microsequencer Status | STATUS | Indicates the state of the microsequencer. |

| | | |
|-------|-----|--------------------------------|
| Clock | CLK | Clock input to the controller. |
|-------|-----|--------------------------------|

Table 3. Signal Index – Continued

| Signal Name | Mnemonic | Function |
|--------------------|-----------------|--------------------|
| Power Supply | VCC | Power supply. |
| Ground | GND | Ground connection. |
| No Connect | NC | Do not connect. |

ELECTRICAL SPECIFICATIONS

MAXIMUM RATINGS

| Rating | Symbol | Value | Unit |
|---|----------------|--------------|------|
| Supply Voltage | V_{CC} | -0.3 to +7.0 | V |
| Input Voltage | V_{in} | -0.5 to +7.0 | V |
| Operating Temperature Range Minimum Ambient Temperature Maximum Ambient Temperature | T_A T_A | 0 70 | °C |
| Storage Temperature Range | T_{stg} | -55 to 150 | °C |

The device contains circuitry to protect the inputs against damage due to high static voltages or electric fields; however, normal precautions should be taken to avoid application of voltages higher than maximum-rated voltages to these high-impedance circuits. Tying unused inputs to the appropriate logic voltage level (e.g., either GND or V_{CC}) enhances reliability of operation.

THERMAL CHARACTERISTICS-- PGA PACKAGE

| Characteristic | Symbol | Value | Rating |
|---|--------------------------------|-----------|--------|
| Thermal Resistance - Plastic Junction to Ambient Junction to case | θ_{JA} θ_{JC} | 32 TBD | °C/W |

POWER CONSIDERATIONS

The average chip-junction temperature, T_J , in °C can be obtained from:

$$T_J = T_A + (P_D \cdot \theta_{JA}) \quad (1)$$

where:

- T_A = Ambient Temperature, °C
- θ_{JA} = Package Thermal Resistance, Junction-to-Ambient, °C/W
- P_D = $P_{INT} + P_{I/O}$
- P_{INT} = $I_{CC} \times V_{CC}$, Watts — Chip Internal Power
- $P_{I/O}$ = Power Dissipation on Input and Output Pins — User Determined

For most applications, $P_{I/O} < P_{INT}$ and can be neglected.

The following is an approximate relationship between P_D and T_J (if $P_{I/O}$ is neglected):

$$P_D = K \div (T_J + 273^\circ\text{C}) \quad (2)$$

Solving Equations (1) and (2) for K gives:

$$K = P_D \cdot (T_A + 273^\circ\text{C}) + \theta_{JA} \cdot P_D^2 \quad (3)$$

where K is a constant pertaining to the particular part. K can be determined from equation (3) by measuring P_D (at thermal equilibrium) for a known T_A . Using this value of K, the values of P_D and T_J can be obtained by solving equations (1) and (2) iteratively for any value of T_A .

The total thermal resistance of a package (θ_{JA}) can be separated into two components, θ_{JC} and θ_{CA} , representing the barrier to heat flow from the semiconductor junction to the package (case) surface (θ_{JC}) and from the case to the outside ambient air (θ_{CA}). These terms are related by the equation:

$$\theta_{JA} = \theta_{JC} + \theta_{CA} \quad (4)$$

θ_{JC} is device related and cannot be influenced by the user. However, θ_{CA} is user dependent and can be minimized by such thermal management techniques as heat sinks, ambient air cooling, and thermal convection. Thus, good thermal management on the part of the user can significantly reduce θ_{CA} so that θ_{JA} approximately equals θ_{JC} . Substitution of θ_{JC} for θ_{JA} in equation (1) results in a lower semiconductor junction temperature.

Values for thermal resistance presented in this document, unless estimated, were derived using the procedure described in Motorola Reliability Report 7843, "Thermal Resistance Measurement Method for MC68XX Microcomponent Devices," and are provided for design purposes only. Thermal measurements are complex and dependent on procedure and setup. User derived values for thermal resistance may differ.

AC ELECTRICAL SPECIFICATION DEFINITIONS

The AC specifications presented consist of output delays, input setup and hold times, and signal skew times. All signals are specified relative to an appropriate edge of the clock and possibly to one or more other signals.

The measurement of the AC specifications is defined by the waveforms shown in Figure 9. To test the parameters guaranteed by Motorola, inputs must be driven to the voltage levels specified in Figure 9. Outputs are specified with minimum and/or maximum limits, as appropriate, and are measured as shown in Figure 9. Inputs are specified with minimum setup and hold times, and are measured as shown. Finally, the measurement for signal-to-signal specifications is also shown.

Note that the testing levels used to verify conformance to the AC specifications does not affect the guaranteed DC operation of the device as specified in the DC electrical specifications.

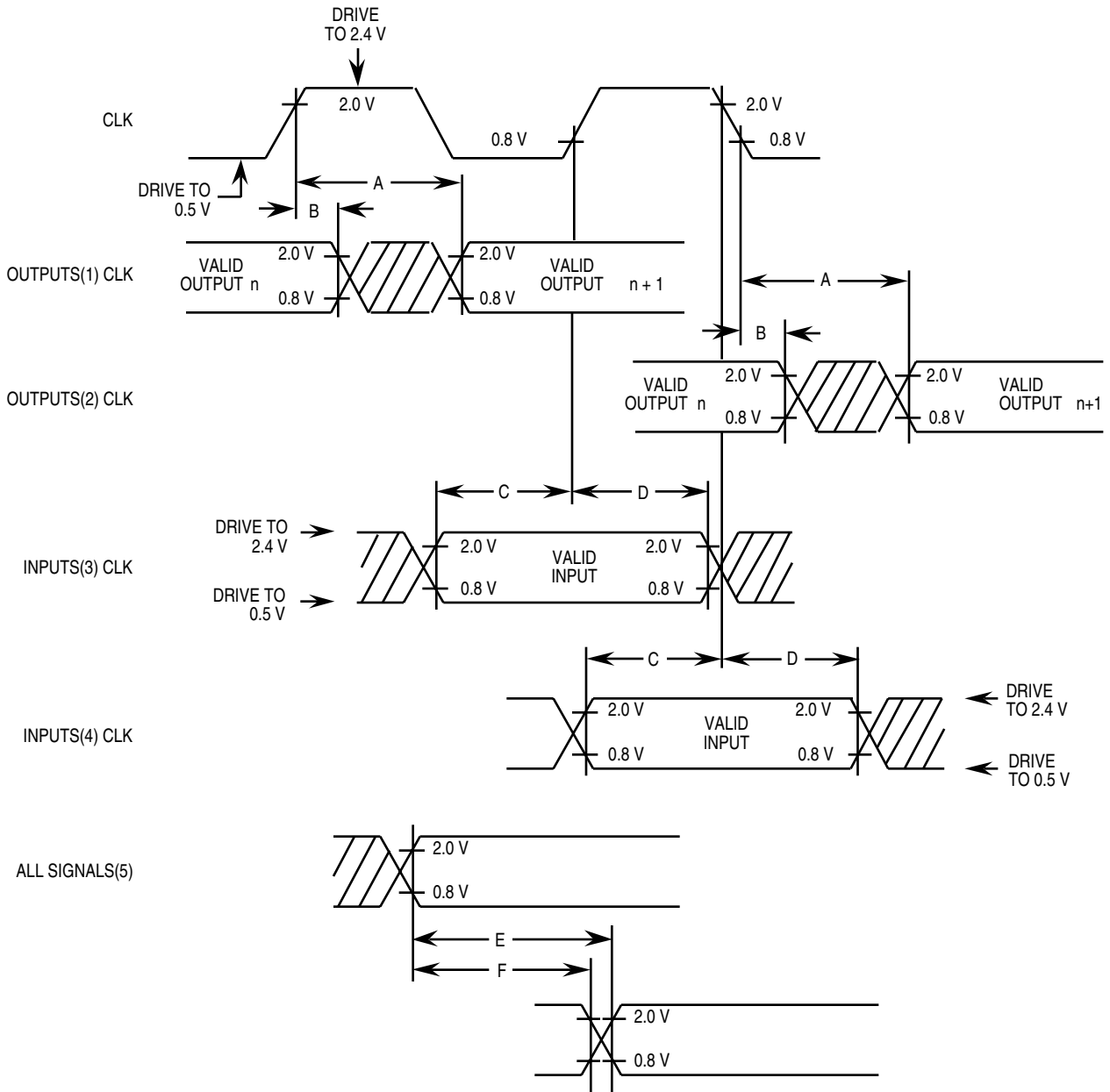

NOTES:

1. This output timing is applicable to all parameters specified relative to the rising edge of the clock.
2. This output timing is applicable to all parameters specified relative to the falling edge of the clock.
3. This input timing is applicable to all parameters specified relative to the rising edge of the clock.
4. This input timing is applicable to all parameters specified relative to the falling edge of the clock.
5. This timing is applicable to all parameters specified relative to the assertion/negation of another signal.

LEGEND:

- A. Maximum output delay specification.
- B. Minimum output hold time.
- C. Minimum input setup time specification.
- D. Minimum input hold time specification.
- E. Signal valid to signal valid specification (maximum or minimum).
- F. Signal valid to signal invalid specification (maximum or minimum).

Figure 9. Drive Levels and Test Points for AC Specifications

DC ELECTRICAL SPECIFICATIONS

(V_{CC}=5.0 Vdc ± 5%; GND=0Vdc; temperature in defined ranges)

| Characteristics | Symbol | Min | Max | Unit |
|---|---|------------------|------------------|-------------------------------|
| Input High Voltage | V _{IH} | 2.0 | V _{CC} | V |
| Input Low Voltage | V _{IL} | GND -0.5 | 0.8 | V |
| Input Leakage Current GND ≤ V _{in} ≤ V _{CC} | BERR, BR, BGACK, CLK, IPL0–IPL2, AVEC, CDIS, DSACK0, DSACK1 HALT, RESET | I _{in} | -2.5 20 | 2.5 μA |
| Hi-Z (Off-State) Leakage Current @ 2.4 V/0.5 V | A0–A31, AS, DBEN, DS, D0–D31, FC0–FC2, R/W, RMC, SIZ0–SIZ1 | I _{TSI} | -20 | 20 μA |
| Output High Voltage I _{OH} = 400 μA | A0–A31, AS, BG, D0–D31, DBEN, DS, ECS, R/W, IPEND OCS, RMC, SIZ0–SIZ1, FC0–FC2 CBREQ, CIOUT, STATUS, REFILL | V _{OH} | 2.4 | — V |
| Output Low Voltage I _{OL} = 3.2 mA I _{OL} = 5.3 mA I _{OL} = 2.0 mA I _{OL} = 10.7 mA | A0–A31, FC0–FC2, SIZ0–SIZ1, BG, D0–D31 CBREQ, AS, DS, R/W, RMC, DBEN, IPEND STATUS, REFILL, CIOUT, ECS, OCS HALT, RESET | V _{OL} | — — — — | 0.5 0.5 0.5 0.5 V |
| Power Dissipation (T _A =0C) | | P _D | — | 2.6 W |
| Capacitance (see Note) V _{in} = 0 V, T _A =25C, f=1 MHz | | C _{in} | — | 20 pF |
| Load Capacitance | ECS, OCS CIOUT, STATUS, REFILL All Other | C _L | — | 50 70 130 pF |

NOTE: Capacitance is periodically sampled rather than 100% tested.

AC ELECTRICAL SPECIFICATIONS — CLOCK INPUT (see Figure 10)

| Num. | Characteristic | 25MHz | | 40 MHz | | Unit |
|------|--|-------|-----|--------|-----|------|
| | | Min | Max | Min | Max | |
| | Frequency of Operation | 12.5 | 25 | 25 | 40 | MHz |
| 1 | Cycle Time Clock | 40 | 80 | 25 | 40 | ns |
| 2,3 | Clock Pulse Width Measured from 1.5 V to 1.5 V | 19 | 61 | 11.5 | 29 | ns |
| 4,5 | Clock Rise and Fall Times | — | 4 | — | 2 | ns |

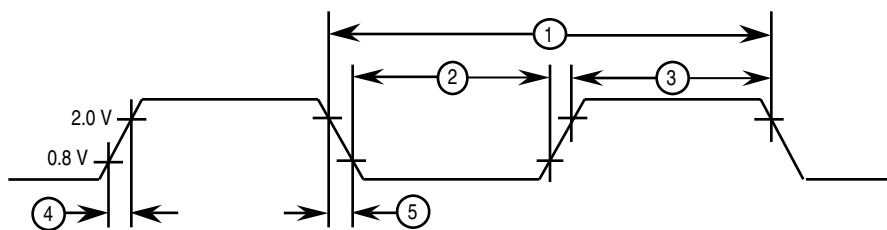

NOTE: Timing measurements are referenced to and from a low voltage of 0.8 V and a high voltage of 2.0 V, unless otherwise noted. The voltage swing through this range should start outside and pass through the range so that the rise or fall will be linear between 0.8 V and 2.0 V.

Figure 10. Clock Input Timing Diagram

AC ELECTRICAL SPECIFICATIONS -- READ AND WRITE CYCLES

($V_{CC}=5.0V_{dc} \pm 5\%$; $GND=0 V_{dc}$; temperature in defined ranges; see Figures 11–16)

| Num. | Characterstics | 25 MHz | | 40 MHz | | Unit |
|-------------------|---|--------|-----|--------|-----|------|
| | | Min | Max | Min | Max | |
| 6 | Clock High to Function Code, Size, RMC, IPEND, CIOUT, Address Valid | 0 | 20 | 0 | 14 | ns |
| 6A | Clock High to ECS, OCS Asserted | 0 | 15 | 0 | 10 | ns |
| 6B | Function Code, Size, RMC, IPEND, CIOUT, Address Valid to Negating Edge of ECS | 3 | — | 3 | — | ns |
| 7 | Clock High to Function Code Size, RMC, CIOUT, Address Data High Impedance | 0 | 40 | 0 | 25 | ns |
| 8 | Clock High to Function Code Size, RMC, IPEND, CIOUT, Address Invalid | 0 | — | 0 | — | ns |
| 9 | Clock Low to AS, DS Asserted, CBREQ Valid | 3 | 18 | 2 | 10 | ns |
| 9A ¹ | AS to DS Assertion Skew (Read) | -10 | 10 | -6 | 6 | ns |
| 9B ¹⁴ | AS Asserted to DS Asserted (Write) | 27 | — | 16 | — | ns |
| 10 | ECS Width Asserted | 10 | — | 5 | — | ns |
| 10A | OCS Width Asserted | 10 | — | 5 | — | ns |
| 10B ⁷ | ECS, OCS Width Negated | 5 | — | 5 | — | ns |
| 11 | Function Code, Size, RMC, CIOUT, Address Valid to AS Asserted (and DS Asserted, Read) | 7 | — | 5 | — | ns |
| 12 | Clock Low to AS, DS, CBREQ Negated | 0 | 18 | 0 | 10 | ns |
| 12A | Clock Low to ECS/OCS Negated | 0 | 18 | 0 | 12 | ns |
| 13 | AS, DS Negated to Function Code, Size, RMC CIOUT, Address Invalid | 7 | — | 3 | — | ns |
| 14 | AS (and DS Read) Width Asserted (Asynchronous Cycle) | 70 | — | 30 | — | ns |
| 14A ¹¹ | DS Width Asserted (Write) | 30 | — | 18 | — | ns |
| 14B | AS (and DS, Read) Width Asserted (Synchronous Cycle) | 30 | — | 18 | — | ns |
| 15 | AS, DS Width Negated | 30 | — | 18 | — | ns |

AC ELECTRICAL SPECIFICATIONS — READ AND WRITE CYCLES

(Continued)

| Num. | Characterstics | 25MHz | | 40 MHz | | Unit |
|---------------------|--|-------|-----|--------|-----|------|
| | | Min | Max | Min | Max | |
| 15A ⁸ | DS Negated to AS Asserted | 25 | — | 16 | — | ns |
| 16 | Clock High to AS, DS, R/W, DBEN, CBREQ High Impedance | — | 40 | — | 25 | ns |
| 17 | AS, DS Negated to R/W Invalid | 7 | — | 3 | — | ns |
| 18 | Clock High to R/W High | 0 | 20 | 0 | 14 | ns |
| 20 | Clock High to R/W Low | 0 | 20 | 0 | 14 | ns |
| 21 | R/W High to AS Asserted | 7 | — | 5 | — | ns |
| 22 | R/W Low to DS Asserted (Write) | 47 | — | 24 | — | ns |
| 23 | Clock High to Data-Out Valid | — | 20 | — | 14 | ns |
| 24 | Data-Out Valid to Negating Edge of AS | 5 | — | 3 | — | ns |
| 25 ¹¹ | AS, DS Negated to Data-Out Invalid | 7 | — | 3 | — | ns |
| 25A ^{9,11} | DS Negated to DBEN Negated (Write) | 7 | — | 3 | — | ns |
| 26 ¹¹ | Data-Out Valid to DS Asserted (Write) | 7 | — | 3 | — | ns |
| 27 | Data-In Valid to Clock Low (Setup) | 2 | — | 1 | — | ns |
| 27A | Late BERR/HALT Asserted to Clock Low (Setup) | 5 | — | 3 | — | ns |
| 28 ¹² | AS, DS Negated to DSACKx, BERR, HALT, AVEC Negated (Asynchronous Hold) | 0 | 40 | 0 | 20 | ns |
| 28A ¹² | Clock Low to DSACKx, BERR, HALT, AVEC Negated (Synchronous Hold) | 8 | 70 | 6 | 40 | ns |
| 29 ¹² | AS, DS Negated to Data-In Invalid (Asynchronous Hold) | 0 | — | 0 | — | ns |
| 29A ¹² | AS, DS Negated to Data-In High Impedance | — | 40 | — | 25 | ns |
| 30 ¹² | Clock Low to Data-In Invalid (Synchronous Hold) | 8 | — | 6 | — | ns |
| 30A ¹² | Clock Low to Data-In High Impedance (Read followed by Write) | — | 60 | — | 30 | ns |
| 31 ² | DSACKx Asserted to Data-In Valid (Asynchronous Data Setup) | — | 28 | — | 14 | ns |
| 31A ³ | DSACKx Asserted to DSACKx Valid (Skew) | — | 7 | — | 3 | ns |
| 32 | RESET Input Transition Time | — | 1.5 | — | 1.5 | Clks |
| 33 | Clock Low to BG Asserted | 0 | 20 | 0 | 14 | ns |
| 34 | Clock Low to BG Negated | 0 | 20 | 0 | 14 | Clks |
| 35 | BR Asserted to BG Asserted (RMC Not Asserted) | 1.5 | 3.5 | 1.5 | 3.5 | Clks |
| 37 | BGACK Asserted to BG Negated | 1.5 | 3.5 | 1.5 | 3.5 | Clks |
| 37A ⁶ | BGACK Asserted to BR Negated | 0 | 1.5 | 0 | 1.5 | ns |
| 39 | BG Width Negated | 60 | — | 30 | — | ns |
| 39A | BG Width Asserted | 60 | — | 30 | — | ns |
| 40 | Clock High to DBEN Asserted (Read) | 0 | 20 | 0 | 16 | ns |
| 41 | Clock Low to DBEN Negated (Read) | 0 | 20 | 0 | 16 | ns |
| 42 | Clock Low to DBEN Asserted (Write) | 0 | 20 | 0 | 16 | ns |
| 43 | Clock High to DBEN Negated (Write) | 0 | 20 | 0 | 16 | ns |

AC ELECTRICAL SPECIFICATIONS — READ AND WRITE CYCLES

(Concluded)

| Num. | Characterstics | 25 MHz | | 40 MHz | | Unit | |
|------------------|---|--------------------|-----|--------|-----|------|----|
| | | Min | Max | Min | Max | | |
| 44 | R/W Low to DBEN Asserted (Write) | 7 | — | 5 | — | ns | |
| 45 ⁵ | DBEN Width Asserted | Asynchronous Read | 40 | — | 22 | — | ns |
| | | Asynchronous Write | 80 | — | 45 | — | |
| 45A ⁹ | DBEN Width Asserted | Synchronous Read | 5 | — | 5 | — | ns |
| | | Synchronous Write | 40 | — | 22 | — | |
| 46 | R/W Width Asserted (Asynchronous Write or Read) | 100 | — | 50 | — | ns | |
| 46A | R/W Width Asserted (Synchronous Write or Read) | 60 | — | 30 | — | ns | |
| 47A | Asynchronous Input Setup Time to Clock Low | 2 | — | 2 | — | ns | |
| 47B | Asynchronous Input Hold Time from Clock Low | 8 | — | 6 | — | ns | |
| 48 ⁴ | DSACKx Asserted to BERR, HALT Asserted | — | 25 | — | 14 | ns | |
| 53 | Data-Out Hold from Clock High | 3 | — | 2 | — | ns | |
| 55 | R/W Asserted to Data Bus Impedance Change | 20 | — | 11 | — | ns | |
| 56 | RESET Pulse Width (Reset Instruction) | 512 | — | 512 | — | Clks | |
| 57 | BERR Negated to HALT Negated (Rerun) | 0 | — | 0 | — | ns | |
| 58 ¹⁰ | BGACK Negated to Bus Driven | 1 | — | 1 | — | Clks | |
| 59 ¹⁰ | BG Negated to Bus Driven | 1 | — | 1 | — | Clks | |
| 60 ¹³ | Synchronous Input Valid to Clock High (Setup Time) | 2 | — | 2 | — | ns | |
| 61 ¹³ | Clock High to Synchronous Input Invalid (Hold Time) | 8 | — | 6 | — | ns | |
| 62 | Clock Low to STATUS, REFILL Asserted | 0 | 20 | 0 | 15 | ns | |
| 63 | Clock Low to STATUS, REFILL Negated | 0 | 20 | 0 | 15 | ns | |

NOTES:

1. This number can be reduced to 5 ns if strobes have equal loads.
2. If the asynchronous setup time (#47A) requirements are satisfied, the DSACK_x low to data setup time (#31) and DSACK_x low to BERR low setup time (#48) can be ignored. The data must only satisfy the data-in clock low setup time (#27) for the following clock cycle and BERR must only satisfy the late BERR low to clock low setup time (#27A) for the following clock cycle.
3. This parameter specifies the maximum allowable skew between DSACK₀ to DSACK₁ asserted or DSACK₁ to DSACK₀ asserted; specification #47A must be met by DSACK₀ or DSACK₁.
4. This specification applies to the first (DSACK₀ or DSACK₁) DSACK_x signal asserted. In the absence of DSACK_x, BERR is an asynchronous input using the asynchronous input setup time (#47A).
5. DBEN may stay asserted on consecutive write cycles.
6. The minimum values must be met to guarantee proper operation. If this maximum value is exceeded, BG may be reasserted.
7. This specification indicates the minimum high time for ECS and OCS in the event of an internal cache hit followed immediately by another cache hit, a cache miss, or an operand cycle.
8. This specification guarantees operation with the MC68881/MC68882, which specifies a minimum time for DS negated to AS asserted (specification #13A in the *MC68881/MC68882 User's Manual*). Without this specification, incorrect interpretation of specifications #9A and #15 would indicate that the MC68EC030 does not meet the MC68881/MC68882 requirements.
9. This specification allows a system designer to guarantee data hold times on the output side of data buffers that have output enable signals generated with DBEN. The timing on DBEN precludes its use for synchronous READ cycles with no wait states.
10. These specifications allow system designers to guarantee that an alternate bus master has stopped driving the bus when the MC68EC030 regains control of the bus after an arbitration sequence.
11. DS will not be asserted for synchronous write cycles with no wait states.
12. These hold times are specified with respect to strobes (asynchronous) and with respect to the clock (synchronous). The designer is free to use either time.
13. Synchronous inputs must meet specifications #60 and #61 with stable logic levels for **all** rising edges of the clock while AS is asserted. These values are specified relative to the high level of the rising clock edge. The values originally published were specified relative to the low level of the rising clock edge.
14. This specification allows system designers to qualify the CS signal of an MC68881/MC68882 with AS (allowing 7 ns for a gate delay) and still meet the CS to DS setup time requirement (spec 8B of the *MC68881/MC68882 User's Manual*).

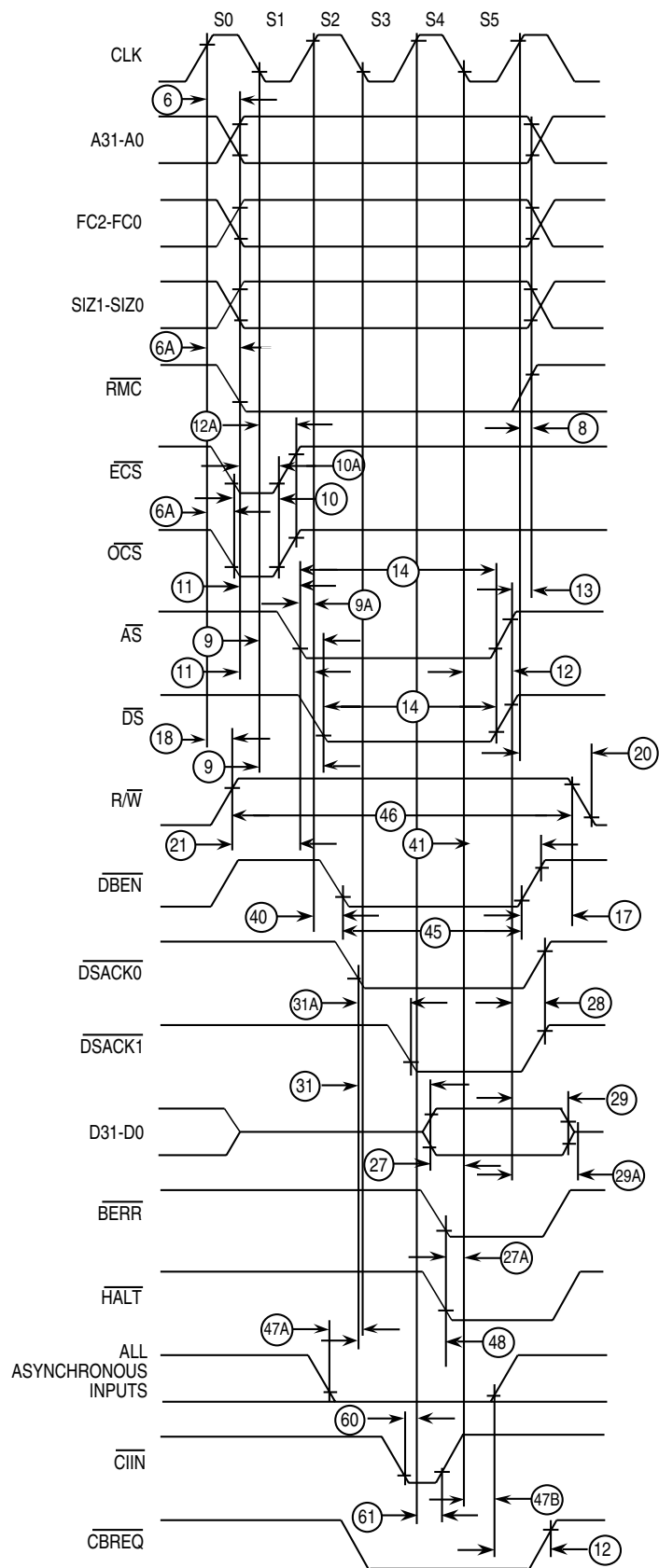

Figure 11. Asynchronous Read Cycle Timing Diagram

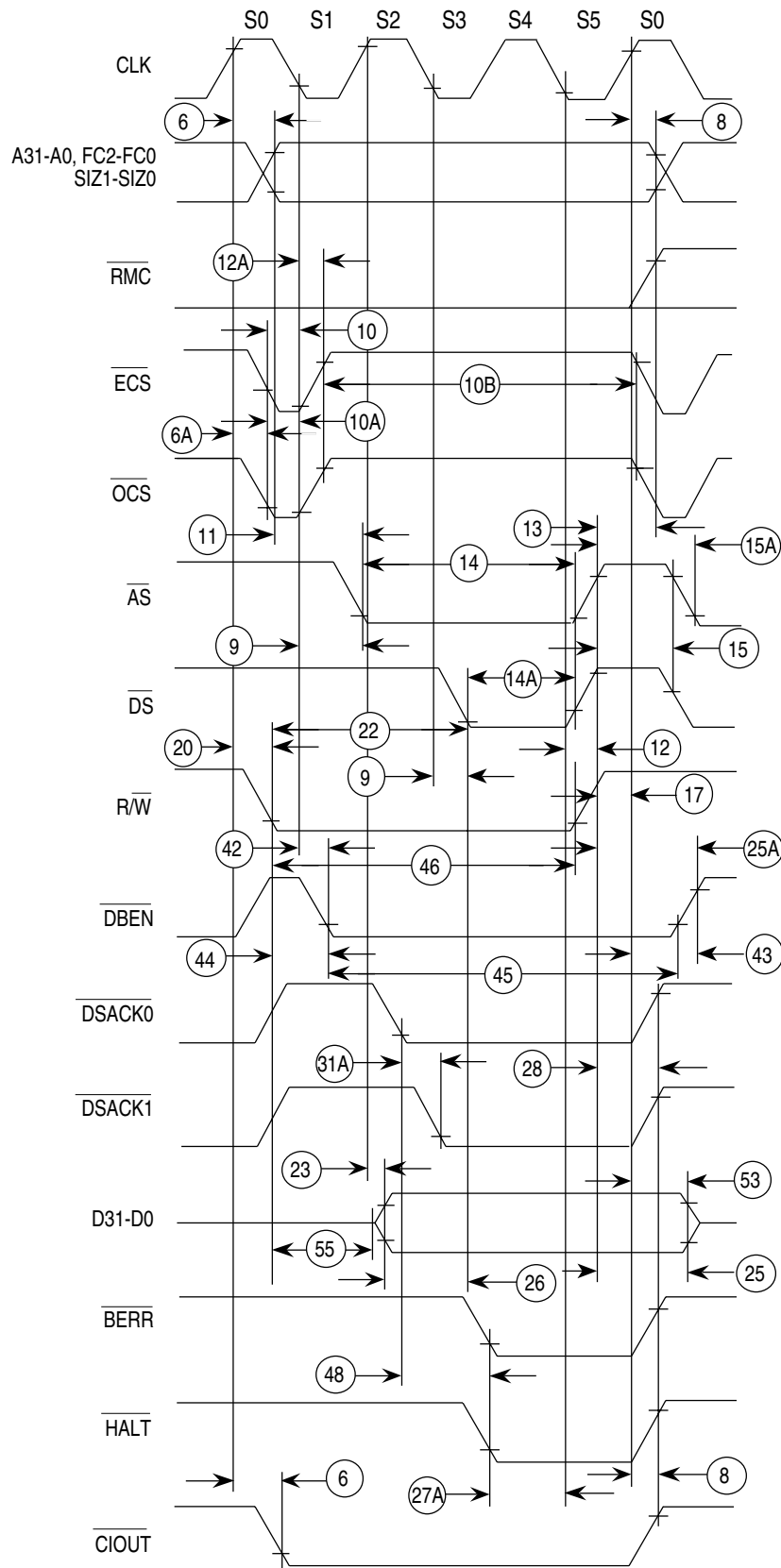

Figure 12. Asynchronous Write Cycle Timing Diagram

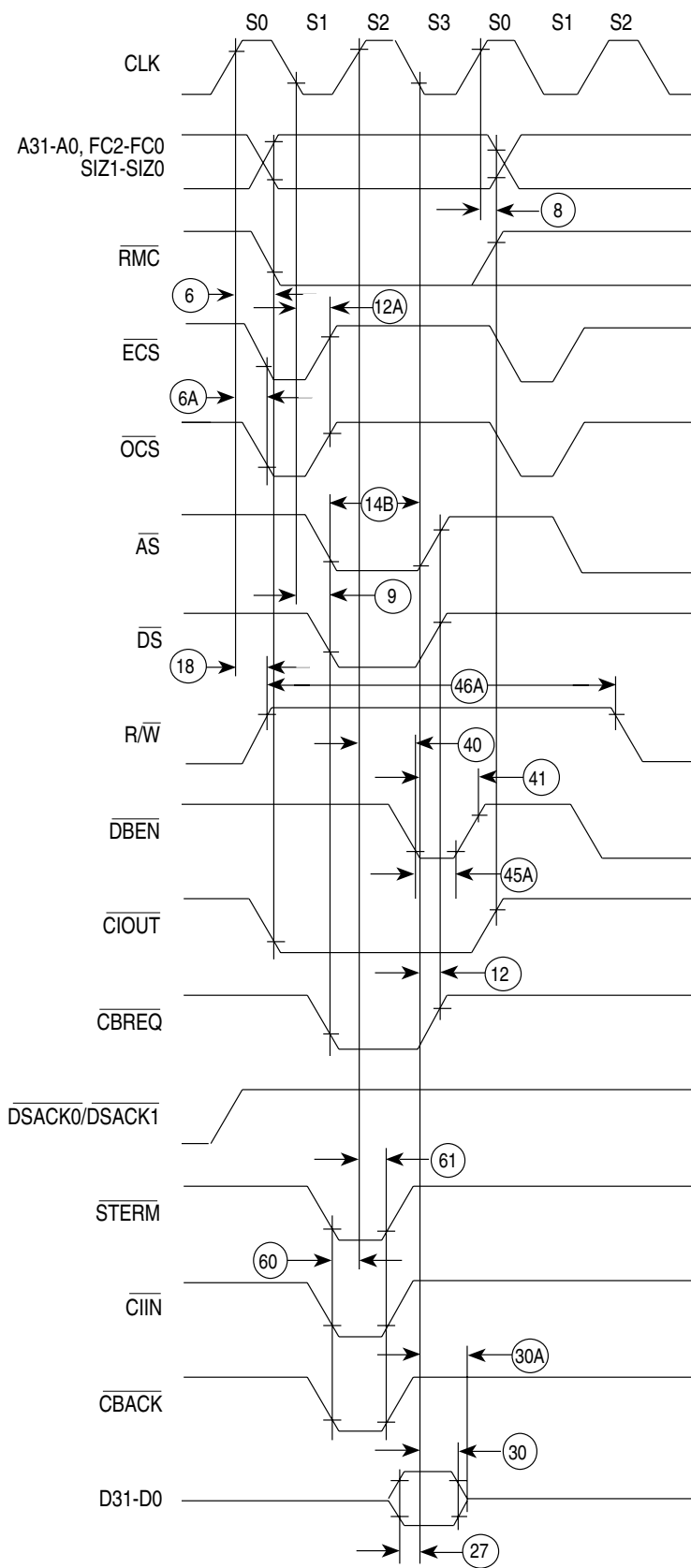

Figure 13. Synchronous Read Cycle Timing Diagram

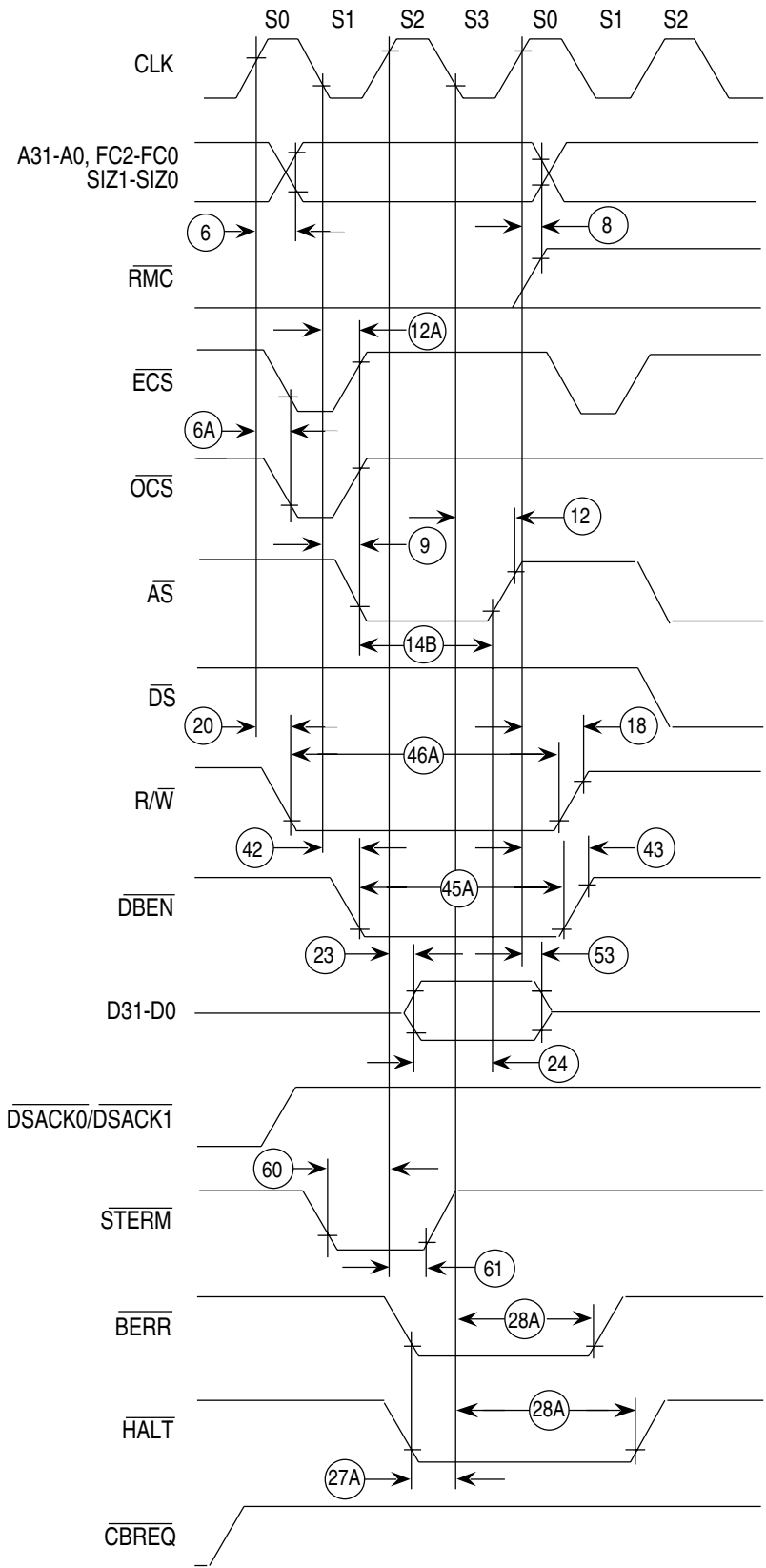
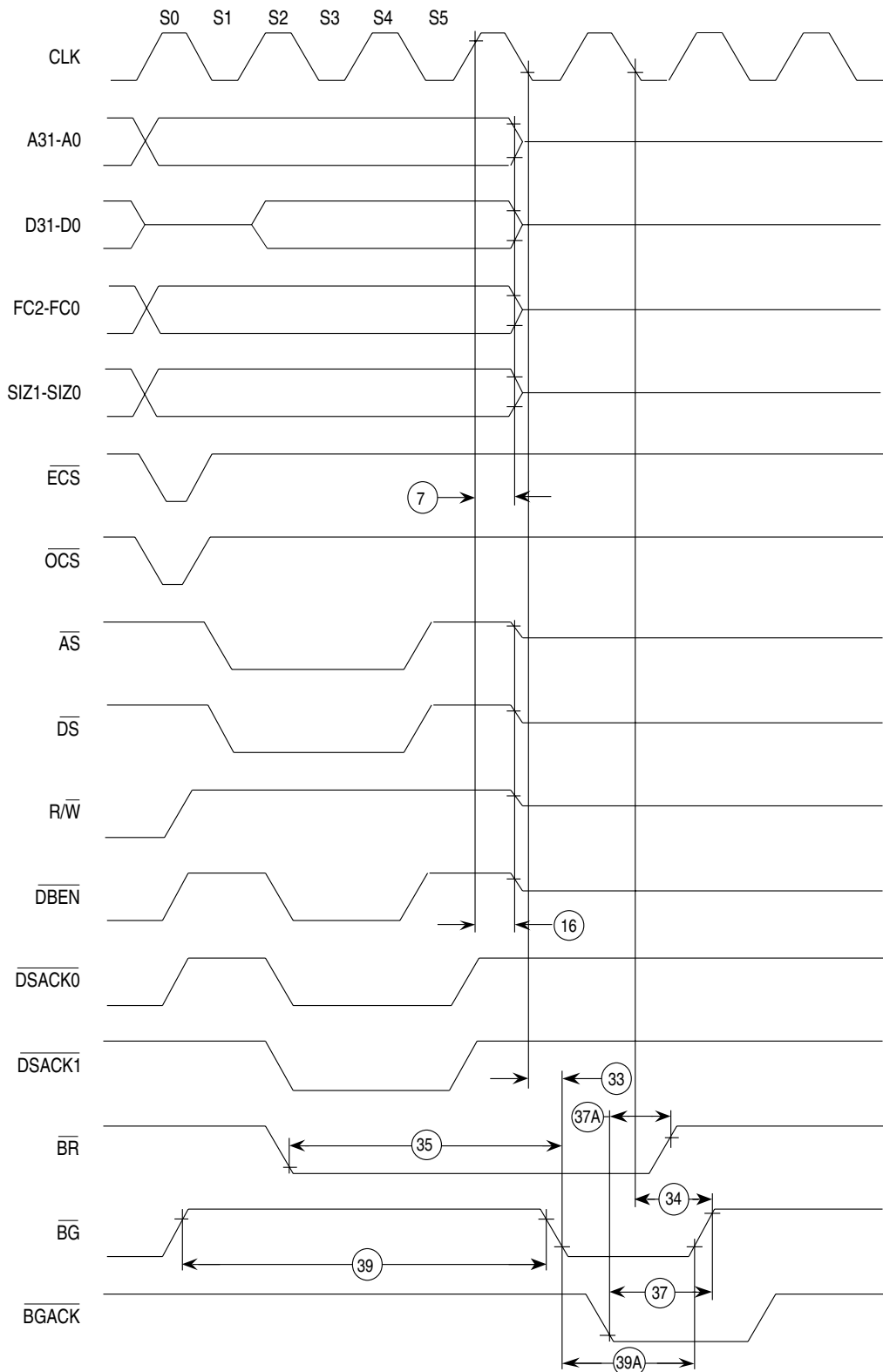

Figure 14. Synchronous Write Cycle Timing Diagram



NOTE: Timing measurements are referenced to and from a low voltage of 0.8 V and a high voltage of 2.0 V, unless otherwise noted. The voltage swing through this range should start outside and pass through the range so that the rise or fall will be linear between 0.8 V and 2.0 V.

Figure 15. Bus Arbitration Timing Diagram

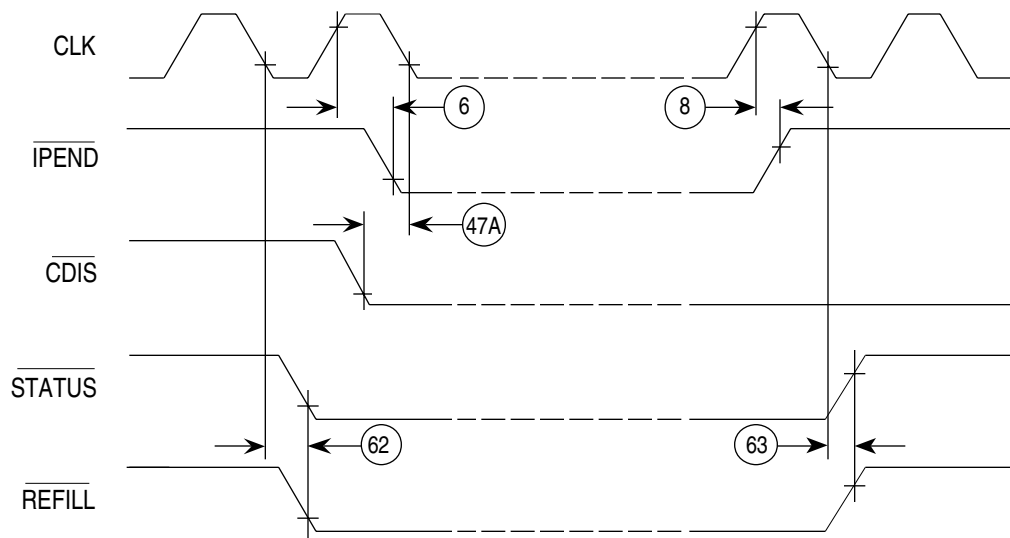
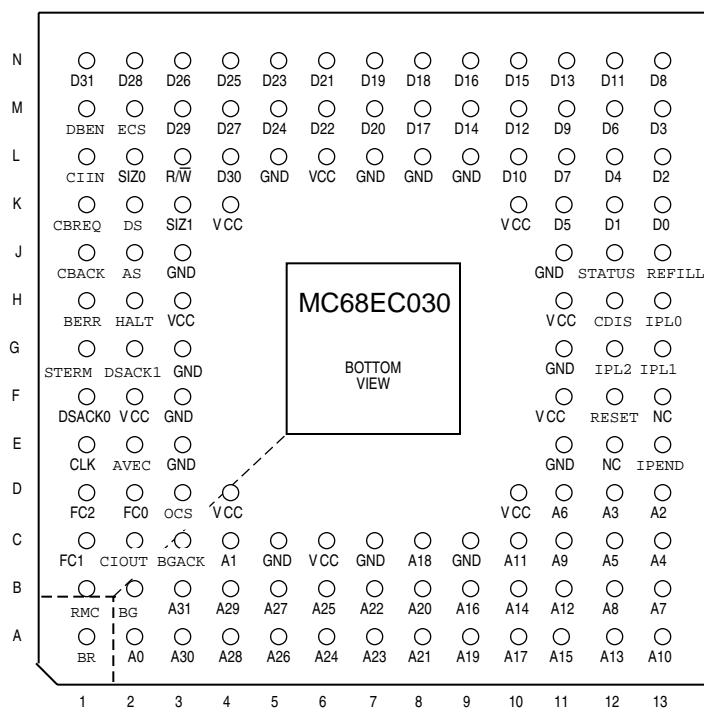

Figure 16. Other Signal Timings

MECHANICAL DATA

PIN ASSIGNMENTS — PIN GRID ARRAY (RC SUFFIX)



NOTE

The MC68030 has four additional guide pins not present on the MC68EC030. Therefore, an MC68EC030 fits in a socket designed for the MC68030, but the MC68030 does not necessary fit in a socket intended for the MC68EC030.

The Vcc and GND pins are separated into three groups to provide individual power supply connections for the address bus buffers, data bus buffers, and all other output buffers and internal logic

| Pin Group | VCC | GND |
|--|------------------|-----------------|
| Address Bus | C6, D10 | C5, C7, C9, E11 |
| Data Bus | L6, K10 | J11, L9, L7, L5 |
| ECS, SIZ _x , DS, AS, DBEN, CBREQ, R/W | K4 | J3 |
| FC0–FC2, RMS, OCS, CIOUT, BG | D4 | E3 |
| Internal Logic, RESET, STATUS, REFILL, Misc | H3, F2, F11, H11 | L8, G3, F3, G11 |

PACKAGE DIMENSIONS

MC68EC030
RP SUFFIX PACKAGE
CASE 789F-01

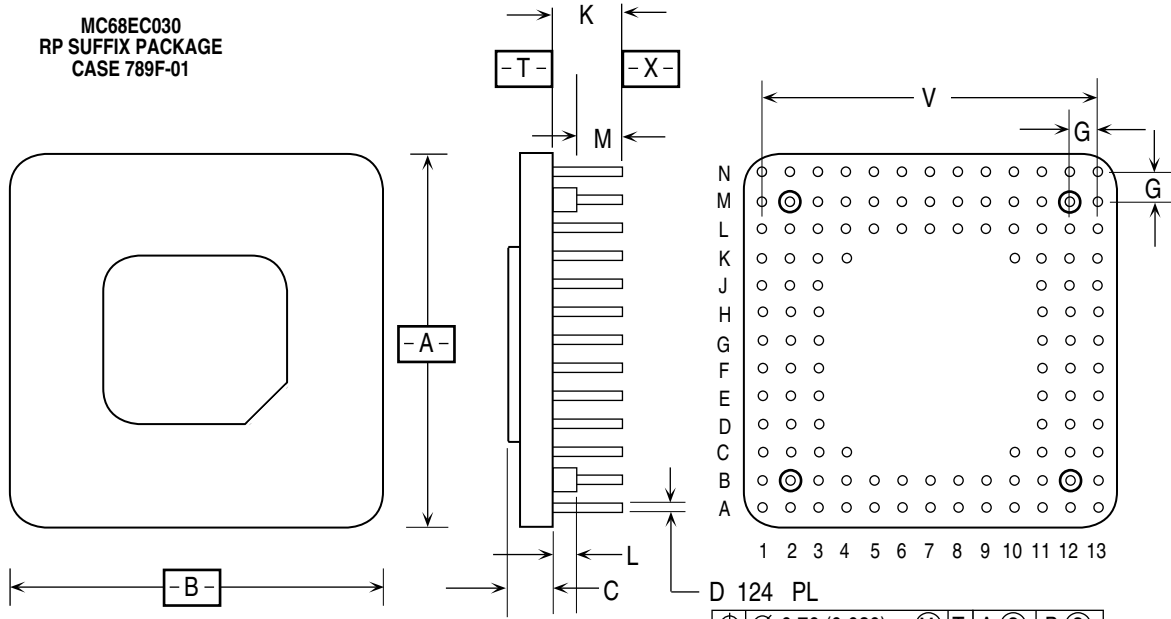

D 124 PL

| | | | | | |
|---|----------------|-----|---|-------|-------|
| ⊕ | ∅ 0.76 (0.030) | (M) | T | A (S) | B (S) |
| ⊖ | ∅ 0.76 (0.030) | (M) | X | | |
| ⊥ | 0.17(0.007) | (M) | T | | |

| DIM | MILLIMETERS | | INCHES | |
|-----|-------------|-------|-----------|-------|
| | MIN | MAX | MIN | MAX |
| A | 34.04 | 35.05 | 1.340 | 1.380 |
| B | 34.04 | 35.05 | 1.340 | 1.380 |
| C | 2.92 | 3.18 | 0.115 | 0.135 |
| D | 0.44 | 0.55 | 0.017 | 0.022 |
| G | 2.54 BSC | | 0.100 BSC | |
| K | 4.32 | 4.95 | 0.170 | 0.195 |
| L | 1.02 | 1.52 | 0.040 | 0.060 |
| M | 2.79 | 3.81 | 0.110 | 0.150 |
| V | 30.48 BSC | | 1.200 BSC | |

NOTES:

1. DIMENSIONING AND TOLERANCING PER ANSI Y14.5M, 1982.
2. CONTROLLING DIMENSION: INCH
3. DIMENSION D INCLUDES LEAD FINISH.

Motorola reserves the right to make changes without further notice to any products herein to improve reliability, function or design. Motorola does not assume any liability arising out of the application or use of any product or circuit described herein; neither does it convey any license under its patent rights nor the rights of others. Motorola products are not designed, intended, or authorized for use as components in systems intended for surgical implant into the body, or other applications intended to support or sustain life, or for any other application in which the failure of the Motorola product could create a situation where personal injury or death may occur. Should Buyer purchase or use Motorola products for any such unintended or unauthorized application, Buyer shall indemnify and hold Motorola and its officers, employees, subsidiaries, affiliates, and distributors harmless against all claims, costs, damages, and expenses, and reasonable attorney fees arising out of, directly or indirectly, any claim of personal injury or death associated with such unintended or unauthorized use, even if such claim alleges that Motorola was negligent regarding the design or manufacture of the part. Motorola and the Motorola logo are registered trademarks of Motorola, Inc. Motorola, Inc. is an Equal Opportunity/Affirmative Action Employer.

Literature Distribution Centers:

USA: Motorola Literature Distribution: P.O. Box 20912; Phoenix, Arizona 85036.

EUROPE: Motorola Ltd.; European Literature Center; 88 Tanners Drive Blakelands, Milton Keynes, MK14 5BP, England.

JAPAN: Nippon Motorola Ltd.; 4-32-1, Nishi-Gotanda, Shinagawa-ku, Tokyo 141 Japan.

ASIA-PACIFIC: Motorola Semiconductors H.K. Ltd.; Silicon Harbour Center, No. 2 Dai King Street, Tai Po Industrial Estate, Tai Po, N.T., Hong Kong.



MOTOROLA



hit C

[Motorola](#) : [Semiconductors](#) : [Product Catalog](#) : [32-Bit Embedded Processors](#) : [68K/ColdFire](#) : [68K M680X0](#) : MC68030

MC68030 : Enhanced 32-Bit Processor

The MC68030 provides a code-compatible upgrade path to the MC68020. It offers enhanced performance through additional cache, a memory management unit, and a bursting data bus. The MC68EC030 offers a lower cost embedded solution by removing the memory management unit.

[Link](#) [Block Diagram](#)

MC68030 Features

- On-Chip Memory Management Unit (MC68030)
- Internal Harvard Architecture
- 256 Byte Instruction and Data Caches
- Dynamic Bus Sizing
- Burst Memory Interface
- 18 MIPS @ 50MHz
- Available in 16, 20, 25, 33, 40, and 50 MHz
- MC68EC030 Available in 25 and 40 MHz

[\[top\]](#)

MC68030 Parametrics

| Processor Speed (MHz) | Performance_1 (Max) (MIPS) | Cache-L1 Inst/Data (Bytes) | Bus Interface (Bits) | Memory | Availability |
|------------------------|----------------------------|----------------------------|----------------------|-------------|--------------|
| 16, 20, 25, 33, 40, 50 | 18 | 256 Bytes | 32-Bit, Dynamic | On-Chip MMU | Now |

[\[top\]](#)

MC68030 Documentation

[Brochure](#)



Page Contents

- [Features](#)
- [Parametrics](#)
- [Documentation](#)
- [Design Tools](#)
- [Orderable Parts](#)
- [Related Links](#)

Other Info

- [FAQs](#)
- [Literature Services](#)
- [68K/ColdFire®](#)
- [3rd Party Design Help](#)

| ID | Name | Format | Size K | Rev # | Date Last Modified | Order Availability |
|------------------------------|--------------------------------|--------|--------|-------|--------------------|--------------------------|
| CFPITCHPAK/D | 68K ColdFire Product Portfolio | html | 1 | 0 | 10/14/2002 | <input type="checkbox"/> |

Data Sheets

| ID | Name | Format | Size K | Rev # | Date Last Modified | Order Availability |
|-----------------------------|---|--------|--------|-------|--------------------|--------------------|
| MC68EC030TS | MC68EC030TS Second-Generation 32-Bit Enhanced Embedded Controller | pdf | 169 | 1 | 10/22/1997 | - |

Packages & Pinouts

| ID | Name | Format | Size K | Rev # | Date Last Modified | Order Availability |
|---------------------------|--|--------|--------|-------|--------------------|--------------------|
| MC68030RC | 68030 RC Package Pinout and Case Diagram | pdf | 541 | - | - | - |

Product Change Notices

| ID | Name | Format | Size K | Rev # | Date Last Modified | Order Availability |
|---------------------------|--|--------|--------|-------|--------------------|--------------------|
| PCN2560 | MC68030 (RP Package Addendum) - PCN #2560 | html | 4 | - | 2/28/1997 | - |
| PCN2921 | MC68030 /68EC030 TQFP End-of-Life Announcement- PCN#2921 | html | 5 | - | 6/30/1997 | - |
| PCN2999 | Standardize Packing Quantity for 68030/68040 - PCN #2999 | html | 7 | - | 8/19/1997 | - |
| PCN5325 | PCN #5325 Citizen RP Package Discontinuance | html | 7 | - | 12/22/1999 | - |
| PCN5826 | Laser Marking of MC68020RC/030RC Devices, PCN #5826 | txt | 4 | - | 8/22/2000 | - |
| PCN6093 | 68020/030 RP Package Discontinuance, PCN #6093 | txt | 6 | - | 11/21/2000 | - |
| PCNR00268 | F91C Mask Set Introduction #R00268 | html | 6 | - | 8/22/1995 | - |
| PCNR00272 | Additional Passivatrion Machines for the 68030-PCN #MPU-PCN-95-R00272 | html | 7 | - | 4/04/1995 | - |
| PCNR00274 | E71M and E42K MC-Qualified Mask Sets - PCN# MPU-PCN-95-R00274 | html | 13 | - | 5/03/1995 | - |
| PCNR00281 | Die Attach Change for Ceramic Quad Flat Packages (CQFP)- PCN #R00281 | html | 8 | - | 8/15/1995 | - |
| PCNR00282 | Addendum to PCN# MPU-PCN-95-R00268 #R00282 | html | 4 | - | 8/22/1995 | - |
| PCNR00283 | Introduction of F91C (0.8 Micron 68030) in Plastic Packages - PCN# MPU-PCN-95-R00283 | html | 6 | - | 8/23/1995 | - |
| PCNR00320 | Moisture Sensitivity Level change for 144 TQFP Products - PCN# R00320 | html | 8 | - | 7/13/1996 | - |
| PCNR00321 | MC68030 Alternate Wafer Fab and Mask Set Introduction - PCN #R00321 | html | 22 | - | 8/05/1996 | - |

Quality Information

| ID | Name | Format | Size K | Rev # | Date Last Modified | Order Availability |
|---------------------------|---|--------|--------|-------|--------------------|--------------------|
| PRODRELOI | Product Reliability Information (2Q97-3Q98) | html | 4 | - | 12/31/1998 | - |
| REL4Q98QI | Product Reliability Information 4Q98 | pdf | 160 | - | 12/31/1998 | - |

Reference Manual

| ID | Name | Format | Size K | Rev # | Date Last Modified | Order Availability |
|--------------------------------|---|--------|--------|-------|--------------------|--------------------|
| M68000PRM | 68000 Family Programmer's Reference Manual | pdf | 2338 | - | - | - |
| M68000PRMER | 68K Programmer's Ref. Manual Errata | txt | 0 | - | - | - |
| MC68030UM-P1/D | MC68030 Enhanced Microprocessor User's Manual (Part 1 of 2) | pdf | 855 | 3 | 1/01/1992 | - |
| MC68030UM-P2/D | MC68030 User's Manual (Part 2 of 2) | pdf | 781 | 1 | 1/01/1992 | - |
| MC68030UM/D | MC68030 Enhanced 32-Bit Microprocessor User's Manual (Complete) | pdf | 1441 | 3 | 1/01/1992 | - |
| MC68EC030UM/AD | MC68EC030 32-Bit Embedded Controller User's Manual Addendum | pdf | 72 | 2 | 4/17/1996 | - |

Reports or Presentations

| ID | Name | Format | Size K | Rev # | Date Last Modified | Order Availability |
|-------------------------------|-------------------------------|--------|--------|-------|--------------------|--------------------|
| MC680X0OPTAPP | Optimizing 680X0 Applications | txt | 12 | - | - | - |

Selector Guide

| ID | Name | Format | Size K | Rev # | Date Last Modified | Order Availability |
|--------------------------|----------------------------|--------|--------|-------|--------------------|--------------------------|
| SG1001/D | 32-Bit Embedded Processors | pdf | 587 | 0 | 6/27/2002 | <input type="checkbox"/> |

[\[top\]](#)

Design Tools

Benchmark

| ID | Name | Vendor ID | Format | Size K | Rev # |
|----------------------------|---|-----------|--------|--------|-------|
| 68KDHR1 | Dhrystone 1.1 Benchmark C Source Code File | MOTOROLA | txt | 8 | - |
| 68KDHR2-P1 | Dhrystone 2.1 Benchmarking Part 1 (C Header File) | MOTOROLA | txt | 17 | - |
| 68KDHR2-P2 | Dhrystone 2.1 Benchmarking Part 1 (C Source) | MOTOROLA | txt | 6 | 2.1 |

| | | | | | |
|----------------------------|---|----------|-----|---|---|
| 68KDHR2-P3 | Dhrystone 2.1 Benchmarking Part 3 (C Source) | MOTOROLA | txt | 5 | - |
| M68KACKBM | Ackerman Benchmark With a Downloadable C Source Code File | MOTOROLA | txt | 1 | - |
| M68KFIBBM | Fibonacci Benchmark With Downloadable C Source Code File | MOTOROLA | txt | 1 | - |
| M68KSIEBM | Sieve Benchmark With Downloadable C Source Code File | MOTOROLA | txt | 1 | - |

Converters

| ID | Name | Vendor ID | Format | Size K | Rev # |
|----------------------------|--|-----------|--------|--------|-------|
| PORTASM68K | MicroAPL Limited's ColdFire Assembler Converter -- FREE! | MICROAPL | html | 1 | 1.2.7 |

Miscellaneous

| ID | Name | Vendor ID | Format | Size K | Rev # |
|-------------------------------|---|-----------|--------|--------|-------|
| M68000AMPRT | Amiga Port of Matthew Brandt's CC68K Compiler | MOTOROLA | html | 0 | - |
| M68000AS332 | AS332.ARC-Freeware | MOTOROLA | arc | 57 | - |
| M68000ASMBLR | 68K Assembler v 2.71 | MOTOROLA | lzh | 54 | - |
| M68000ASS_SIM | 68000 Assembler/Simulator for MS-DOS | MOTOROLA | zip | 157 | - |
| M68000BFP | S-Record to C-Struct or Binary File Program | MOTOROLA | txt | 7 | - |
| M68000CPLR | 68K Compiler | MOTOROLA | html | 0 | - |
| M68000UNIX | 68K Assembler-Berkeley UNIX | MOTOROLA | arc | 68 | - |
| M68000XASS | M680x0 cross assembler MS-DOS | MOTOROLA | zip | 114 | - |

Software

| ID | Name | Vendor ID | Format | Size K | Rev # |
|---------------------------|--|-----------|--------|--------|-------|
| M68000MTS | Memory Test Software for 68K Memory Test Software for the M68000 Family | MOTOROLA | pdf | 115 | 0 |

[\[top\]](#)

Orderable Parts Information

| PartNumber | Package Info | Life Cycle Description (code) | Remarks | Budgetary Price QTY 1000+ (\$US) | Order Availability |
|-----------------|--------------------------------|---|--|--|--------------------------|
| MC68EC030FE25C | 132 CQUAD (Ceramic Quad) | PRODUCT MATURITY/SATURATION(4) | Embedded 030 (No MMU); Samples can be ordered on this device number | \$20.71 | <input type="checkbox"/> |
| MC68EC030FE40C | 132 CQUAD (Ceramic Quad) | PRODUCT MATURITY/SATURATION(4) | Embedded 030 (No MMU); Samples can be ordered on this device number | \$28.71 | <input type="checkbox"/> |
| MC68EC030CFE25C | 132 CQUAD (Ceramic Quad) | PRODUCT MATURITY/SATURATION(4) | Ext Temp, Embedded 030 (No MMU); Samples can be ordered on this device number | \$29.84 | <input type="checkbox"/> |
| MC68030FE16C | 132 CQUAD (Ceramic Quad) | PRODUCT MATURITY/SATURATION(4) | On-Chip Cache and MMU; Samples can be ordered on this device number | \$31.15 | <input type="checkbox"/> |
| MC68030FE20C | 132 CQUAD (Ceramic Quad) | PRODUCT MATURITY/SATURATION(4) | On-Chip Cache and MMU; Samples can be ordered on this device number | \$31.15 | <input type="checkbox"/> |
| MC68030FE25C | 132 CQUAD (Ceramic Quad) | PRODUCT MATURITY/SATURATION(4) | On-Chip Cache and MMU; Samples can be ordered on this device number | \$39.27 | <input type="checkbox"/> |

| | | | | | |
|--------------|-----------------------------------|-----------------------------------|---|---------|--------------------------|
| MC68030FE33C | 132 CQUAD (Ceramic Quad) | PRODUCT MATURITY/SATURATION(4) | On-Chip Cache and MMU; Samples can be ordered on this device number | \$39.27 | <input type="checkbox"/> |
| MC68030RC16C | 128 PGA (Pin Grid Array) | PRODUCT MATURITY/SATURATION(4) | On-Chip Cache and MMU; Samples can be ordered on this device number | \$41.71 | <input type="checkbox"/> |
| MC68030RC20C | 128 PGA (Pin Grid Array) | PRODUCT MATURITY/SATURATION(4) | On-Chip Cache and MMU; Samples can be ordered on this device number | \$41.71 | <input type="checkbox"/> |
| MC68030RC25C | 128 PGA (Pin Grid Array) | PRODUCT MATURITY/SATURATION(4) | On-Chip Cache and MMU; Samples can be ordered on this device number | \$47.41 | <input type="checkbox"/> |
| MC68030RC33C | 128 PGA (Pin Grid Array) | PRODUCT MATURITY/SATURATION(4) | On-Chip Cache and MMU; Samples can be ordered on this device number | \$47.41 | <input type="checkbox"/> |
| MC68030RC40C | 128 PGA (Pin Grid Array) | PRODUCT MATURITY/SATURATION(4) | On-Chip Cache and MMU; Samples can be ordered on this device number | \$52.67 | <input type="checkbox"/> |
| MC68030RC50C | 128 PGA (Pin Grid Array) | PRODUCT MATURITY/SATURATION(4) | On-Chip Cache and MMU; Samples can be ordered on this device number | \$58.38 | <input type="checkbox"/> |

| | | | | | |
|---------------|-----------------------------|-----------------------------------|---|---------|--------------------------|
| MC68030CRC25C | 128 PGA (Pin Grid Array) | PRODUCT MATURITY/SATURATION(4) | Ext Temp, On-Chip Cache and MMU; Samples can be ordered on this device number | \$62.64 | <input type="checkbox"/> |
| MC68030CRC33C | 128 PGA (Pin Grid Array) | PRODUCT MATURITY/SATURATION(4) | Ext Temp, On-Chip Cache and MMU; Samples can be ordered on this device number | \$71.37 | <input type="checkbox"/> |

[\[top\]](#)

Related Links

[Link](#) [68K/ColdFire Site](#)

[\[top\]](#)

[Motorola Home](#) | [Semiconductors](#) | [Login](#) | [Support](#) | [Contact Us](#) | [Site Map](#)
[Products](#) | [Documentation](#) | [Tools](#) | [Design Resources](#) | [Applications](#)



Semiconductors

[Motorola](#) > [Semiconductors](#) >

MC68030 : Enhanced 32-Bit Processor



The MC68030 provides a code-compatible upgrade path to the MC68020. It offers enhanced performance through additional cache, a memory management unit, and a bursting data bus. The MC68EC030 offers a lower cost embedded solution by removing the memory management unit.







 [Block Diagram](#)

MC68030 Features





- On-Chip Memory Management Unit (MC68030)
- Internal Harvard Architecture
- 256 Byte Instruction and Data Caches
- Dynamic Bus Sizing
- Burst Memory Interface
- 18 MIPS @ 50MHz
- Available in 16, 20, 25, 33, 40, and 50 MHz
- MC68EC030 Available in 25 and 40 MHz

 [Return to Top](#)

Page Contents:

-  [Features](#)
-  [Documentation](#)
-  [Tools](#)
-  [Orderable Parts](#) 
-  [Related Links](#)

Other Info:

-  [FAQs](#)
-  [3rd Party Design Help](#)
-  [Training](#)
-  [3rd Party Tool](#)
-  [Vendors](#)

Rate this Page

--
 -
 0
 +
 ++

Care to Comment?

MC68030 Documentation

Documentation Brochure

| ID | Name | Vendor ID | Format | Size K | Rev # | Date Last Modified | Order Availability |
|----------------------------|--------------------------------|-----------|--------|--------|-------|--------------------|---|
| CFPITCHPAK | 68K ColdFire Product Portfolio | MOTOROLA | html | 1 | 0 | 10/14/2002 |  |

Data Sheets

| ID | Name | Vendor ID | Format | Size K | Rev # | Date Last Modified | Order Availability |
|-----------------------------|---|-----------|--------|--------|-------|--------------------|--------------------|
| MC68EC030TS | MC68EC030TS Second-Generation 32-Bit Enhanced Embedded Controller | MOTOROLA | pdf | 169 | 1 | 10/22/1997 | - |

Packaging Information

| ID | Name | Vendor ID | Format | Size K | Rev # | Date Last Modified | Order Availability |
|---------------------------|--|-----------|--------|--------|-------|--------------------|--------------------|
| MC68030RC | 68030 RC Package Pinout and Case Diagram | MOTOROLA | pdf | 541 | - | - | - |

Product Change Notices

| ID | Name | Vendor ID | Format | Size K | Rev # | Date Last Modified | Order Availability |
|---------------------------|--|-----------|--------|--------|-------|--------------------|--------------------|
| PCN2560 | MC68030 (RP Package Addendum) - PCN #2560 | MOTOROLA | html | 4 | - | 2/28/1997 | - |
| PCN2921 | MC68030 /68EC030 TQFP End-of-Life Announcement-PCN#2921 | MOTOROLA | html | 5 | - | 6/30/1997 | - |
| PCN2999 | Standardize Packing Quantity for 68030/68040 - PCN #2999 | MOTOROLA | html | 7 | - | 8/19/1997 | - |
| PCN5325 | PCN #5325 Citizen RP Package Discontinuance | MOTOROLA | html | 7 | - | 12/22/1999 | - |
| PCN5826 | Laser Marking of MC68020RC/030RC Devices, PCN #5826 | MOTOROLA | txt | 4 | - | 8/22/2000 | - |
| PCN6093 | 68020/030 RP Package Discontinuance, PCN #6093 | MOTOROLA | txt | 6 | - | 11/21/2000 | - |
| PCNR00268 | F91C Mask Set Introduction #R00268 | MOTOROLA | html | 6 | - | 8/22/1995 | - |
| PCNR00272 | Additional Passivatrion Machines for the 68030- PCN #MPU-PCN-95-R00272 | MOTOROLA | html | 7 | - | 4/04/1995 | - |
| PCNR00274 | E71M and E42K MC-Qualified Mask Sets - PCN# MPU-PCN-95-R00274 | MOTOROLA | html | 13 | - | 5/03/1995 | - |
| PCNR00281 | Die Attach Change for Ceramic Quad Flat Packages (CQFP)- PCN #R00281 | MOTOROLA | html | 8 | - | 8/15/1995 | - |
| PCNR00282 | Addendum to PCN# MPU-PCN-95-R00268 #R00282 | MOTOROLA | html | 4 | - | 8/22/1995 | - |
| PCNR00283 | Introduction of F91C (0.8 Micron 68030) in Plastic Packages - PCN# MPU-PCN-95-R00283 | MOTOROLA | html | 6 | - | 8/23/1995 | - |
| PCNR00320 | Moisture Sensitivity Level change for 144 TQFP Products - PCN# R00320 | MOTOROLA | html | 8 | - | 7/13/1996 | - |
| PCNR00321 | MC68030 Alternate Wafer Fab and Mask Set Introduction - PCN #R00321 | MOTOROLA | html | 22 | - | 8/05/1996 | - |

Reference Manual

| ID | Name | Vendor ID | Format | Size K | Rev # | Date Last Modified | Order Availability |
|--------------------------------|---|-----------|--------|--------|-------|--------------------|--------------------|
| M68000PRM | 68000 Family Programmer's Reference Manual | MOTOROLA | pdf | 2338 | - | - | - |
| M68000PRMER | 68K Programmer's Ref. Manual Errata | MOTOROLA | txt | 0 | - | - | - |
| MC68030UM-P1/D | MC68030 Enhanced Microprocessor User's Manual (Part 1 of 2) | MOTOROLA | pdf | 855 | 3 | 1/01/1992 | - |
| MC68030UM-P2/D | MC68030 User's Manual (Part 2 of 2) | MOTOROLA | pdf | 781 | 1 | 1/01/1992 | - |
| MC68030UM/D | MC68030 Enhanced 32-Bit Microprocessor User's Manual (Complete) | MOTOROLA | pdf | 1441 | 3 | 1/01/1992 | - |
| MC68EC030UM/AD | MC68EC030 32-Bit Embedded Controller User's Manual Addendum | MOTOROLA | pdf | 72 | 2 | 4/17/1996 | - |

Reliability and Quality Information

| ID | Name | Vendor ID | Format | Size K | Rev # | Date Last Modified | Order Availability |
|---------------------------|---|-----------|--------|--------|-------|--------------------|--------------------|
| PRODRELQI | Product Reliability Information (2Q97-3Q98) | MOTOROLA | html | 4 | - | 12/31/1998 | - |
| REL4Q98QI | Product Reliability Information 4Q98 | MOTOROLA | pdf | 160 | - | 12/31/1998 | - |

Reports or Presentations

| ID | Name | Vendor ID | Format | Size K | Rev # | Date Last Modified | Order Availability |
|-------------------------------|-------------------------------|-----------|--------|--------|-------|--------------------|--------------------|
| MC680X0OPTAPP | Optimizing 680X0 Applications | MOTOROLA | txt | 12 | - | - | - |

Roadmap

| ID | Name | Vendor ID | Format | Size K | Rev # | Date Last Modified | Order Availability |
|----------------------------|------------------------------|-----------|--------|--------|-------|--------------------|--------------------|
| COLDFIRERD | ColdFire Performance Roadmap | MOTOROLA | pdf | 79 | 0 | 10/23/2002 | - |

Selector Guide

| ID | Name | Vendor ID | Format | Size K | Rev # | Date Last Modified | Order Availability |
|------------------------|--|-----------|--------|--------|-------|--------------------|--------------------|
| SG1001 | 32-Bit Embedded Processors - Quarter 4, 2003 | MOTOROLA | pdf | 877 | 1 | 11/07/2003 | |

[Return to Top](#)

MC68030 Tools

Hardware Tools

Emulators/Probes/Wigglers

| ID | Name | Vendor ID | Format | Size K | Rev # | Order Availability |
|-------------------------------|-----------------------------------|------------------------|--------|--------|-------|--------------------|
| HMI-200-68030 | HMI-200-68030 In-Circuit Emulator | AVOCET | - | - | - | - |

Software

Application Software

Code Examples

| ID | Name | Vendor ID | Format | Size K | Rev # | Order Availability |
|----------------------------|---|-----------|--------|--------|-------|--------------------|
| 68KDHR1 | Dhrystone 1.1 Benchmark C Source Code File | MOTOROLA | txt | 8 | - | - |
| 68KDHR2-P1 | Dhrystone 2.1 Benchmarking Part 1 (C Header File) | MOTOROLA | txt | 17 | - | - |
| 68KDHR2-P2 | Dhrystone 2.1 Benchmarking Part 1 (C Source) | MOTOROLA | txt | 6 | 2.1 | - |
| 68KDHR2-P3 | Dhrystone 2.1 Benchmarking Part 3 (C Source) | MOTOROLA | txt | 5 | - | - |
| M68000MTS | Memory Test Software for the M68000 Family | MOTOROLA | pdf | 115 | - | - |
| M68KACKBM | Ackerman Benchmark With a Downloadable C Source Code File | MOTOROLA | txt | 1 | - | - |
| M68KFIBBM | Fibonacci Benchmark With Downloadable C Source Code File | MOTOROLA | txt | 1 | - | - |
| M68KSIEBM | Sieve Benchmark With Downloadable C Source Code File | MOTOROLA | txt | 1 | - | - |

Operating Systems

| ID | Name | Vendor ID | Format | Size K | Rev # | Order Availability |
|-------------------------|---------|---------------------|--------|--------|-------|--------------------|
| CMX-RTX | CMX-RTX | CMX | - | - | - | - |

Protocol Stacks

| ID | Name | Vendor ID | Format | Size K | Rev # | Order Availability |
|----------------------------|------------|---------------------|--------|--------|-------|--------------------|
| CMX TCP/IP | CMX TCP/IP | CMX | - | - | - | - |

Software Tools

Assemblers

| ID | Name | Vendor ID | Format | Size K | Rev # | Order Availability |
|-------------------------------|--|------------------------|--------|--------|-------|--------------------|
| M68000AS332 | AS332.ARC-Freeware | MOTOROLA | arc | 57 | - | - |
| M68000ASMBLR | 68K Assembler v 2.71 | MOTOROLA | lzh | 54 | - | - |
| M68000ASS_SIM | 68000 Assembler/Simulator for MS-DOS | MOTOROLA | zip | 157 | - | - |
| M68000UNIX | 68K Assembler-Berkeley UNIX | MOTOROLA | arc | 68 | - | - |
| M68000XASS | M680x0 cross assembler MS-DOS | MOTOROLA | zip | 114 | - | - |
| ADX-68K | ADX-68K Macro Assembler-Linker and IDE | AVOCET | - | - | - | - |

Code Translation

| ID | Name | Vendor ID | Format | Size K | Rev # | Order Availability |
|----------------------------|--|--------------------------|--------|--------|-------|--------------------|
| M68000BFP | S-Record to C-Struct or Binary File Program | MOTOROLA | txt | 7 | - | - |
| PORTASM68K | MicroAPL Limited's ColdFire Assembler Converter -- FREE! Assembly-language source-code translation tool, converts M680x0 and CPU32 assembly- language code to optimized ColdFire assembly-language. Compatible with the main ColdFire toolsets. | MICROAPL | html | 1 | 1.2.7 | - |







Compilers

| ID | Name | Vendor ID | Format | Size K | Rev # | Order Availability |
|-----------------------------|---|-------------------------|--------|--------|-------|--------------------|
| M68000AMPRT | Amiga Port of Matthew Brandt's CC68K Compiler | MOTOROLA | html | 0 | - | - |
| M68000CPLR | 68K Compiler | MOTOROLA | html | 0 | - | - |
| DIAB | Diab C/C++ Compiler | WINDRIV | - | - | - | - |

[Return to Top](#)

Orderable Parts Information

| PartNumber | Package Info | Tape and Reel | Life Cycle Description (code) | Budgetary Price QTY 1000+ (\$US) | Additional Info | Order Availability |
|---------------|---------------------------|---------------|--------------------------------|----------------------------------|----------------------|---------------------|
| MC68030CRC25C | PGA 128 | No | PRODUCT MATURITY/SATURATION(4) | \$62.64 | more | BUY |
| MC68030CRC33C | PGA 128 | No | PRODUCT MATURITY/SATURATION(4) | \$71.37 | more | BUY |
| MC68030FE16C | CQUAD 132 | No | PRODUCT MATURITY/SATURATION(4) | \$31.15 | more | BUY |
| MC68030FE20C | CQUAD 132 | No | PRODUCT MATURITY/SATURATION(4) | \$31.15 | more | BUY |
| MC68030FE25C | CQUAD 132 | No | PRODUCT MATURITY/SATURATION(4) | \$39.27 | more | BUY |
| MC68030FE33C | CQUAD 132 | No | PRODUCT MATURITY/SATURATION(4) | \$39.27 | more | BUY |
| MC68030RC16C | PGA 128 | No | PRODUCT MATURITY/SATURATION(4) | \$41.71 | more | BUY |
| MC68030RC20C | PGA 128 | No | PRODUCT MATURITY/SATURATION(4) | \$41.71 | more | BUY |

| | | | | | | |
|------------------|---------------------------|----|--------------------------------|---------|----------------------|---|
| MC68030RC25C | PGA 128 | No | PRODUCT MATURITY/SATURATION(4) | \$47.41 | more | BUY  |
| MC68030RC33C | PGA 128 | No | PRODUCT MATURITY/SATURATION(4) | \$47.41 | more | BUY  |
| MC68030RC40C | PGA 128 | No | PRODUCT MATURITY/SATURATION(4) | \$52.67 | more | BUY  |
| MC68030RC50C | PGA 128 | No | PRODUCT MATURITY/SATURATION(4) | \$58.38 | more | BUY  |
| MC68EC030CFE25C | CQUAD 132 | No | PRODUCT MATURITY/SATURATION(4) | \$29.84 | more | BUY  |
| MC68EC030FE25C | CQUAD 132 | No | PRODUCT MATURITY/SATURATION(4) | \$20.71 | more | BUY  |
| MC68EC030FE25CB1 | CQUAD 132 | No | PRODUCT MATURITY/SATURATION(4) | - | more | - |
| MC68EC030FE40C | CQUAD 132 | No | PRODUCT MATURITY/SATURATION(4) | \$28.71 | more | BUY  |

NOTE: Are you looking for an obsolete orderable part? Click [HERE](#) to check our distributors' inventory.

[Return to Top](#)

| | |
|---|----------------------|
|  | Related Links |
| ▶ 68K/ColdFire® ▶ 68K/ColdFire Site | |

[Return to Top](#)