

Darlington

2SD2562

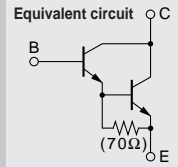

Silicon NPN Triple Diffused Planar Transistor (Complement to type 2SB1649)

Application : Audio, Series Regulator and General Purpose

Absolute maximum ratings (Ta=25°C)

Symbol	Ratings	Unit
VcBO	150	V
VcEO	150	V
VEBO	5	V
Ic	15	A
IB	1	A
Pc	85(Tc=25°C)	W
Tj	150	°C
Tstg	-55 to +150	°C

Electrical Characteristics (Ta=25°C)

Symbol	Conditions	Ratings	Unit
ICBO	VcB=150V	100max	μA
IEBO	VEB=5V	100max	μA
V(BR)CEO	Ic=30mA	150min	V
hFE	VcE=4V, Ic=10A	5000min*	
VcE(sat)	Ic=10A, IB=10mA	2.5max	V
VBE(sat)	Ic=10A, IB=10mA	3.0max	V
fr	VcE=12V, IE=-2A	70typ	MHz
COB	VcB=10V, f=1MHz	120typ	pF

*hFE Rank O(5000to12000), P(6500to20000), Y(15000to30000)

External Dimensions FM100(TO3PF)

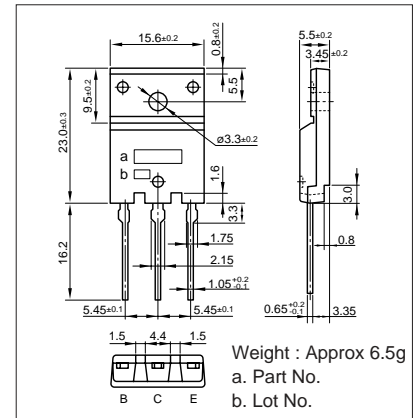

Typical Switching Characteristics (Common Emitter)

Vcc (V)	RL (Ω)	Ic (A)	VBB1 (V)	VBB2 (V)	IB1 (mA)	IB2 (mA)	ton (μs)	tstg (μs)	tf (μs)
40	4	10	10	-5	10	-10	0.8typ	4.0typ	1.2typ

Ic-VcE Characteristics (Typical)

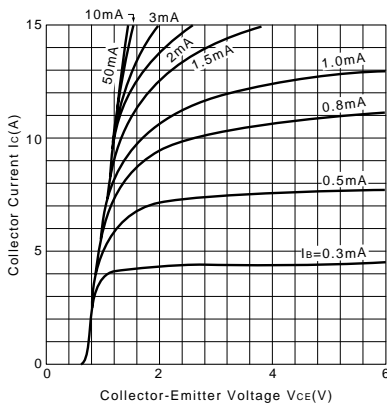

VcE(sat)-IB Characteristics (Typical)

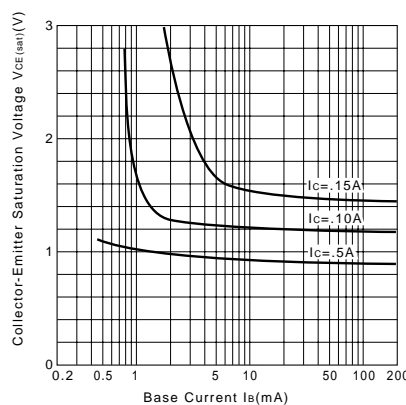

Ic-VBE Temperature Characteristics (Typical)

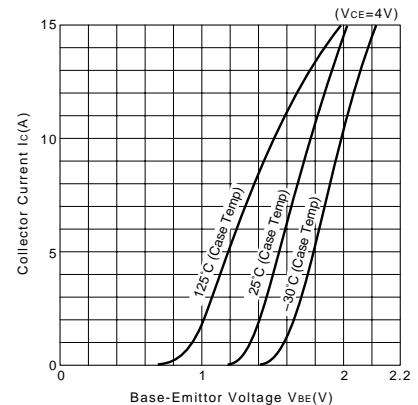

hFE-Ic Characteristics (Typical)

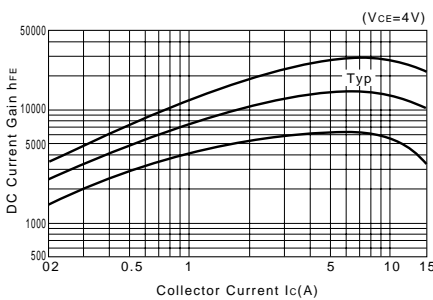

hFE-Ic Temperature Characteristics (Typical)

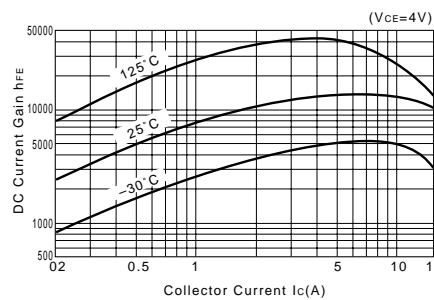

θj-a-t Characteristics

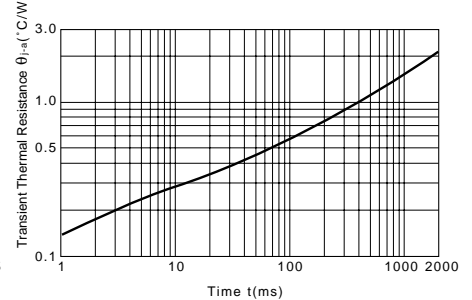

fr-IE Characteristics (Typical)

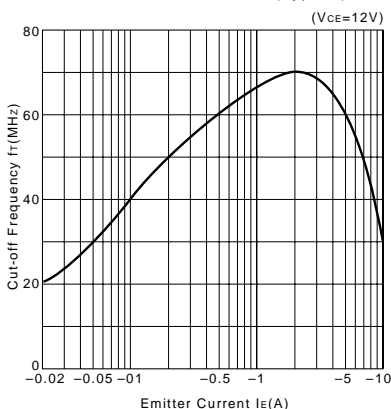

Safe Operating Area (Single Pulse)

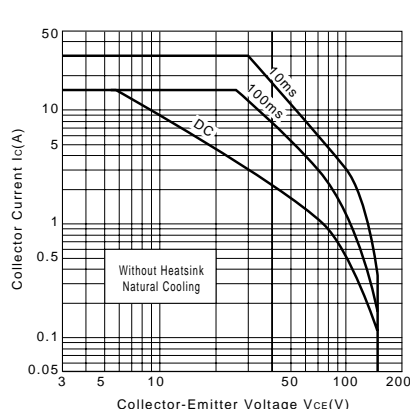

Pc-Ta Derating

