

GaAs pHEMT MMIC POWER AMPLIFIER, 0.2 - 22 GHz

Typical Applications

The HMC907APM5E is ideal for:

- Test Instrumentation
- Military & Space

Features

- High P1dB Output Power: +28 dBm
- High Gain: 14 dB
- High Output IP3: +40 dBm
- Single Supply: +10 V @ 350 mA
- 50 Ohm Matched Input/Output
- 32 Lead 5x5 mm SMT Package: 25 mm²

Functional Diagram

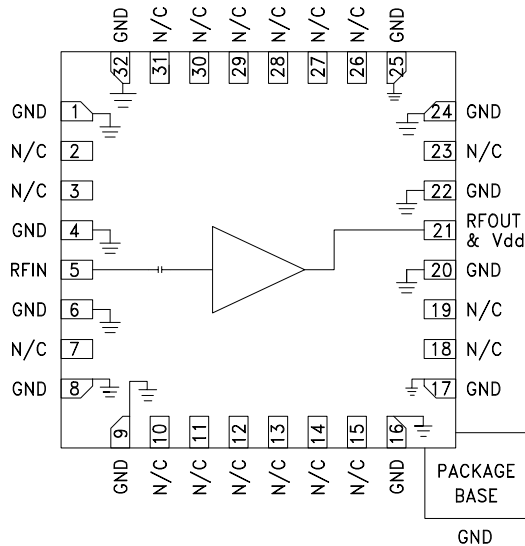

General Description

The HMC907APM5E is a GaAs MMIC pHEMT Distributed Power Amplifier which operates between 0.2 and 22 GHz. This self-biased power amplifier provides 14 dB of gain, +40 dBm output IP3 and +28 dBm of output power at 1 dB gain compression while requiring only 350 mA from a +10 V supply. Gain flatness is excellent at ± 0.7 dB from 0.2 to 22 GHz making the HMC907APM5E ideal for EW, ECM, Radar and test equipment applications. The HMC907APM5E amplifier I/Os are internally matched to 50 Ohms facilitating integration into Mutli-Chip-Modules (MCMs) and is packaged in a leadless QFN 5x5 mm surface mount package, and requires no external matching components.

Electrical Specifications, $T_A = +25^\circ\text{C}$, $V_{dd} = +10\text{V}$, $I_{dd} = 350\text{mA}$

Parameter	Min.	Typ.	Max.	Min.	Typ.	Max.	Min.	Typ.	Max.	Units
Frequency Range	0.2 - 10			10 - 18			18 - 22			GHz
Gain	11	13		11	13		12	14		dB
Gain Flatness		± 0.7			± 0.6			± 0.7		dB
Gain Variation Over Temperature		0.01			0.013			0.014		dB/°C
Input Return Loss		15			15			18		dB
Output Return Loss		14			16			18		dB
Output Power for 1 dB Compression (P1dB)	25	27		25.5	28		24.5	27.5		dBm
Saturated Output Power (Psat)		29			28.5			29		dBm
Output Third Order Intercept (IP3)		38.5			40			40		dBm
Noise Figure		6			3			3.5		dB
Quiescent Current (Idq) at (Vdd= 10V)		350	430		350	430		350	430	mA
Supply Voltage (Vdd)	8	10	11	8	10	11	8	10	11	V

**GaAs pHEMT MMIC
POWER AMPLIFIER, 0.2 - 22 GHz**

Broadband Gain and Return Loss

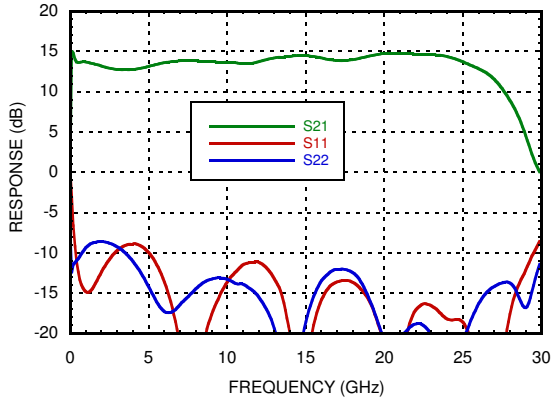

Low Frequency Gain and Return Loss

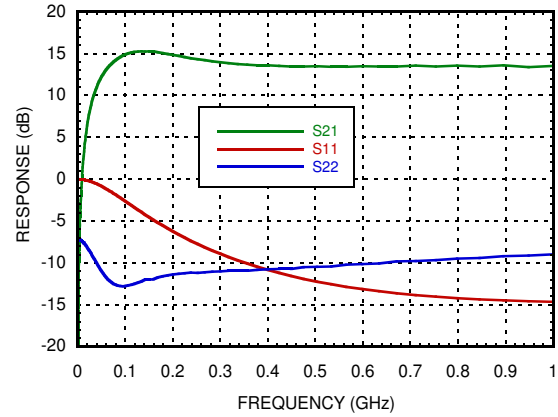

Gain vs. Temperature

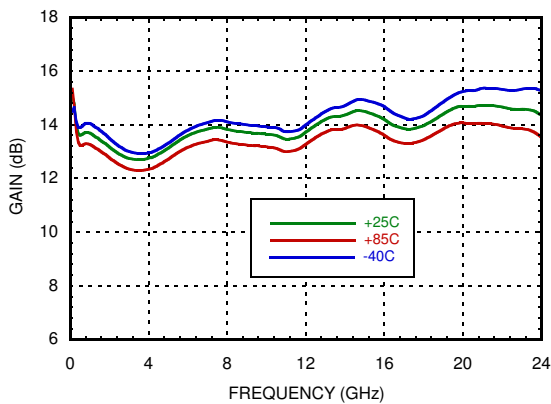

Gain vs. Vdd

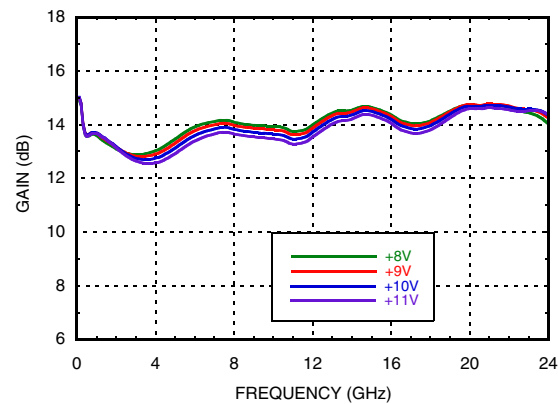

Input Return Loss vs. Temperature

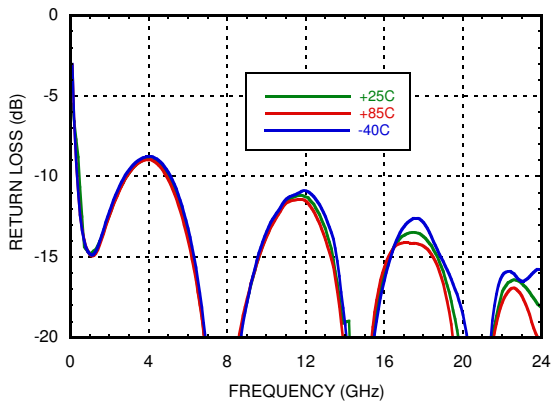

Input Return Loss vs. Vdd

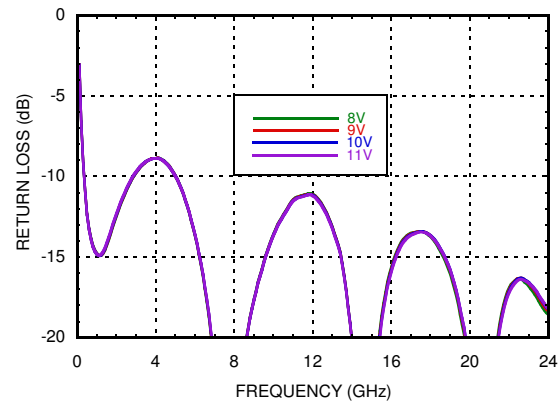

**GaAs pHEMT MMIC
POWER AMPLIFIER, 0.2 - 22 GHz**

Output Return Loss vs. Temperature

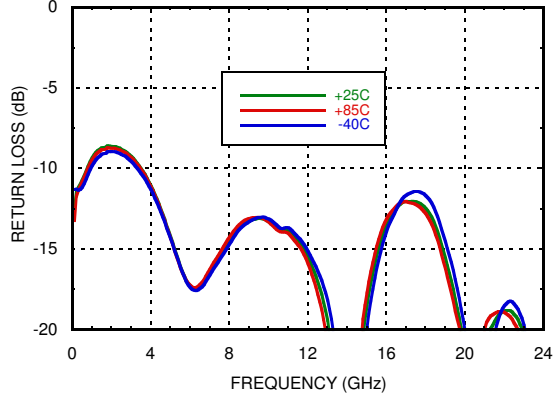

Output Return Loss vs. Vdd

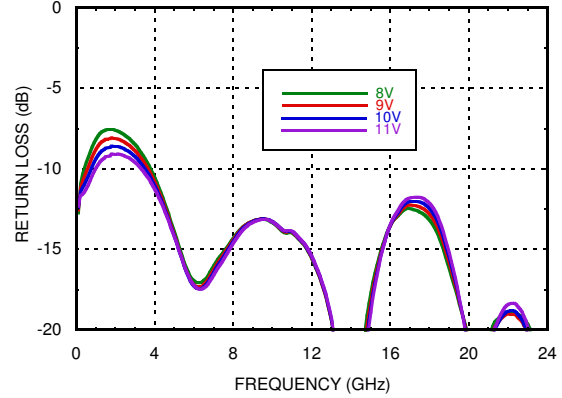

Reverse Isolation vs. Temperature

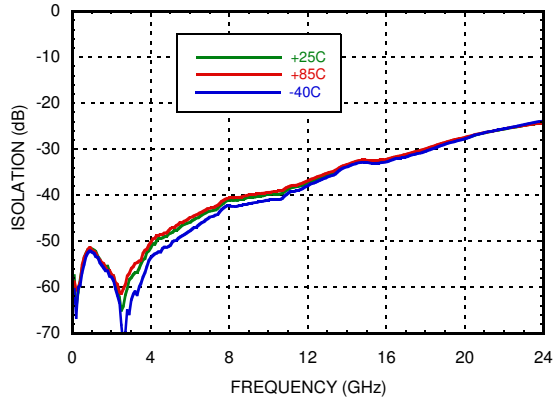

Noise Figure vs. Temperature

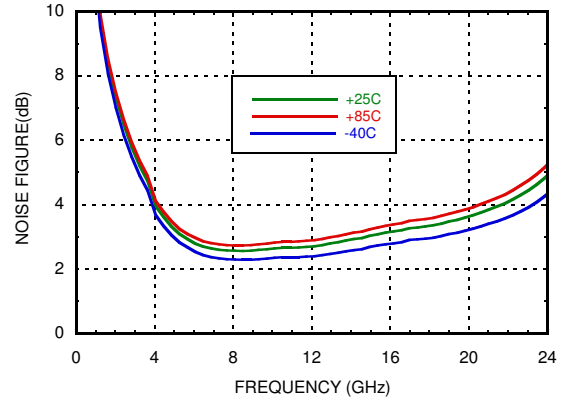

Low Frequency P1dB vs. Temperature

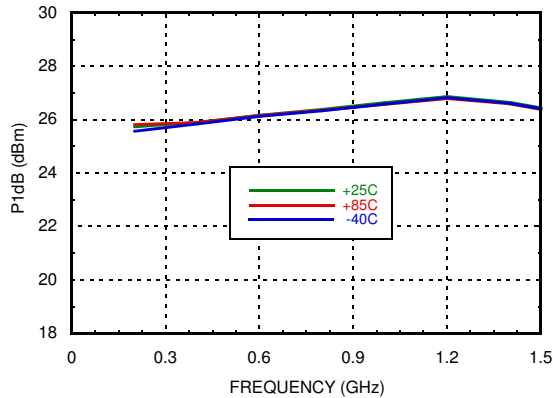

P1dB vs. Temperature

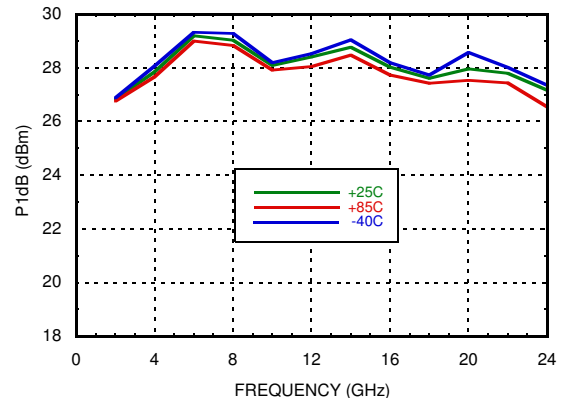

**GaAs pHEMT MMIC
POWER AMPLIFIER, 0.2 - 22 GHz**

P1dB vs. Vdd

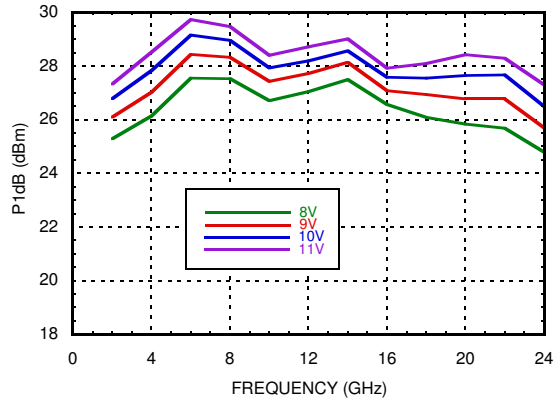

Low Frequency Psat vs. Temperature

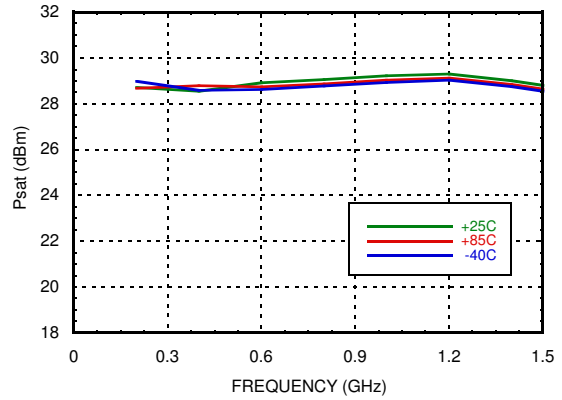

Psat vs. Temperature

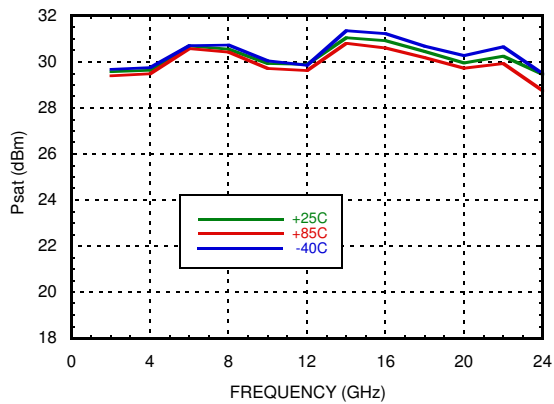

Psat vs. Vdd

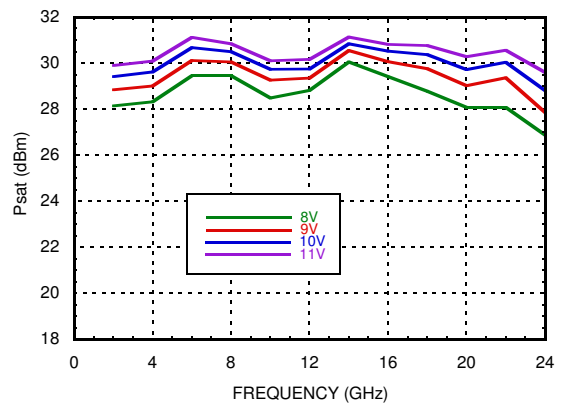

Power Compression @ 2 GHz

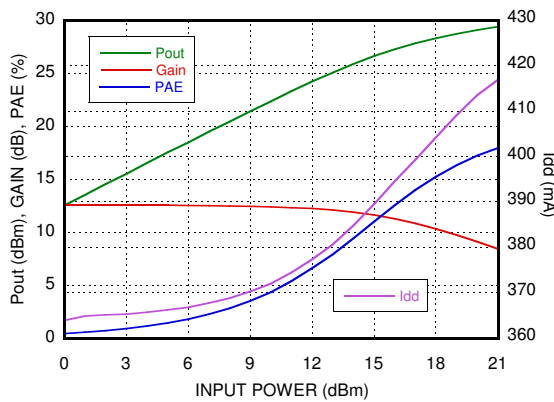

Power Compression @ 6 GHz

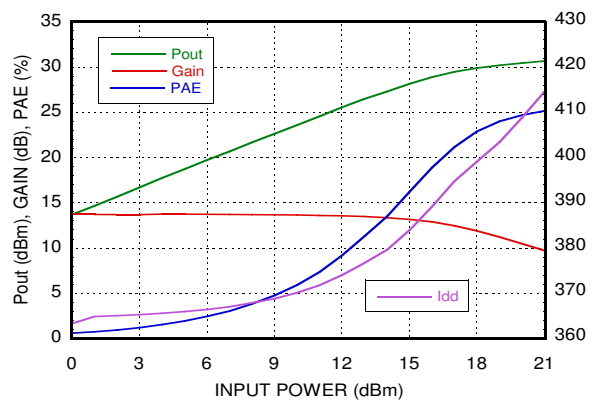

**GaAs pHEMT MMIC
POWER AMPLIFIER, 0.2 - 22 GHz**

Power Compression @ 10 GHz

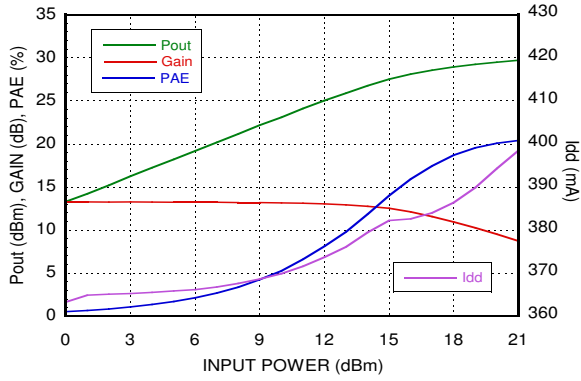

Power Compression @ 14 GHz

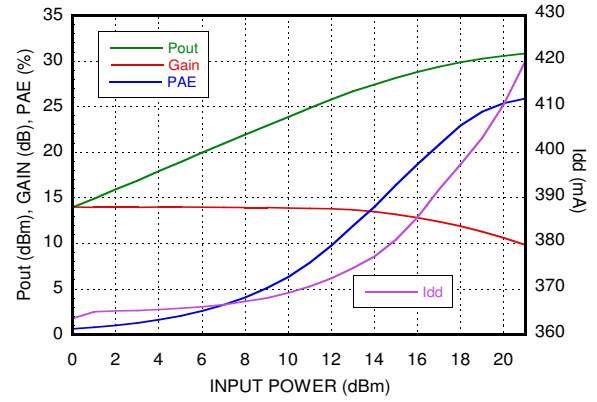

Power Compression @ 18 GHz

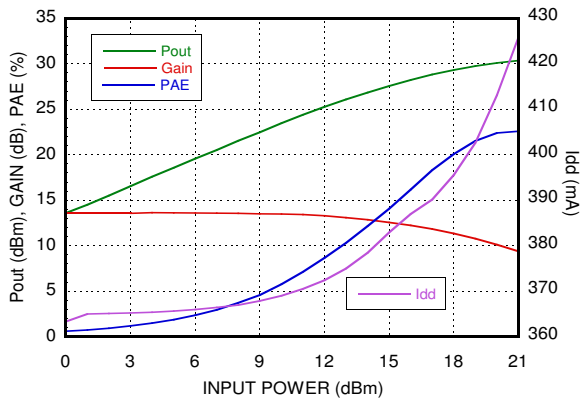

Power Compression @ 22 GHz

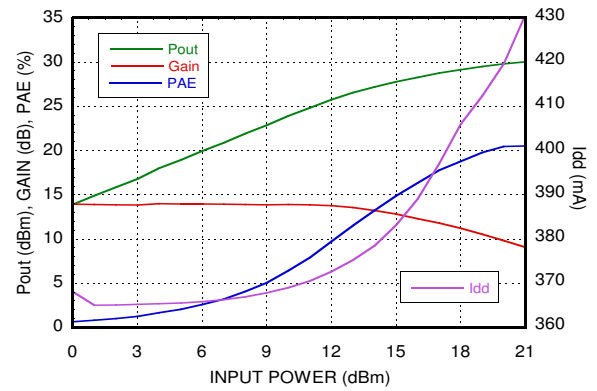

PAE @ Psat vs. Frequency

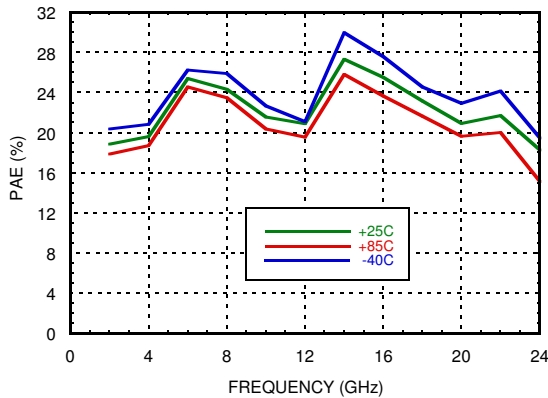

Power Dissipation @ 85 C

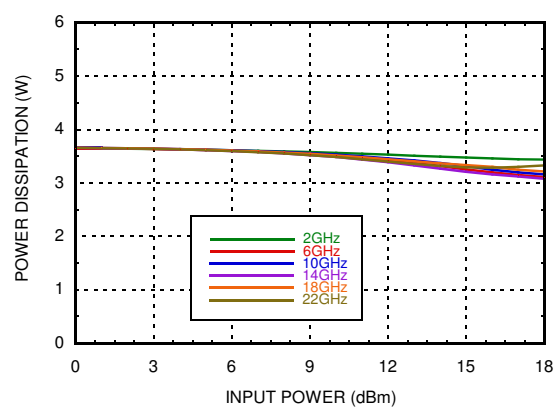

GaAs pHEMT MMIC POWER AMPLIFIER, 0.2 - 22 GHz

Gain & Power vs. Vdd @ 2 GHz

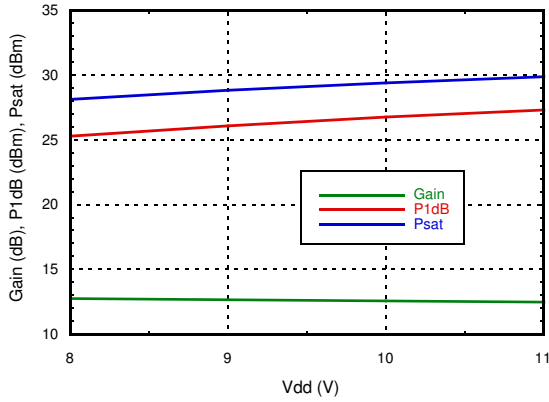

Gain & Power vs. Vdd @ 6 GHz

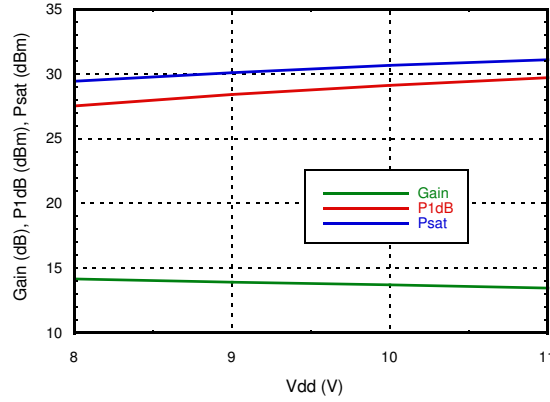

Gain & Power vs. Vdd @ 10 GHz

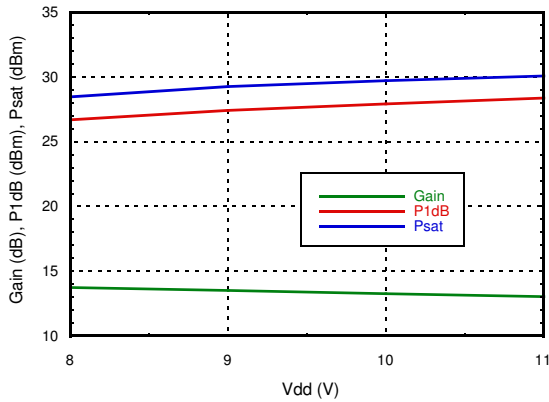

Gain & Power vs. Vdd @ 14 GHz

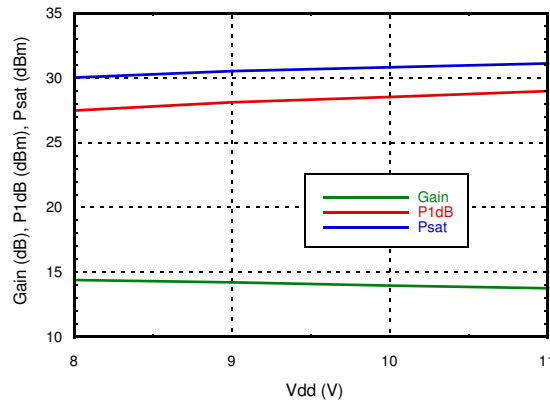

Gain & Power vs. Vdd @ 18 GHz

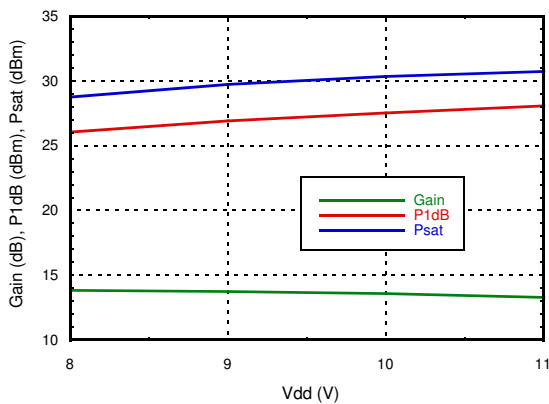

Gain & Power vs. Vdd @ 22 GHz

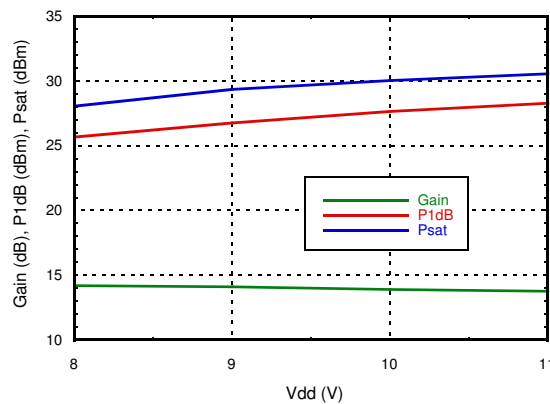

**GaAs pHEMT MMIC
POWER AMPLIFIER, 0.2 - 22 GHz**

**Low Frequency OIP3 vs. Temperature
@ Pout / Tone = +16 dBm**

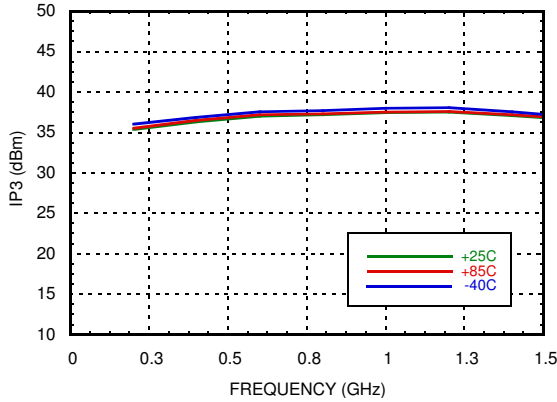

**OIP3 vs. Temperature
@ Pout / Tone = +16 dBm**

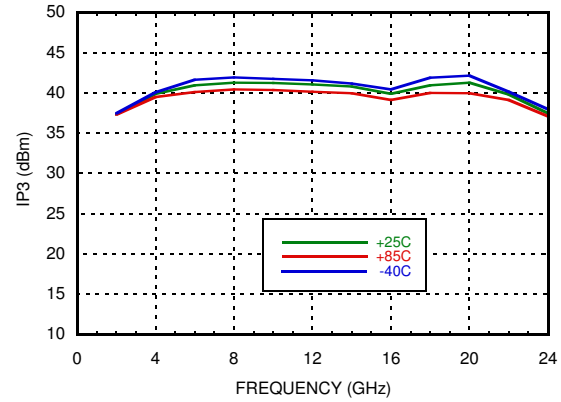

**OIP3 vs Vdd
@ Pout/Tone = +16 dBm**

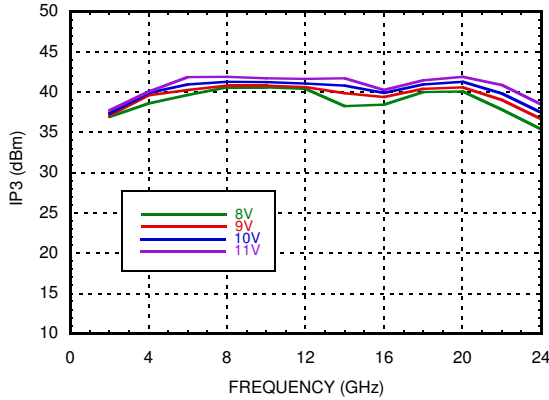

Output IM3 @ Vdd = +8 V

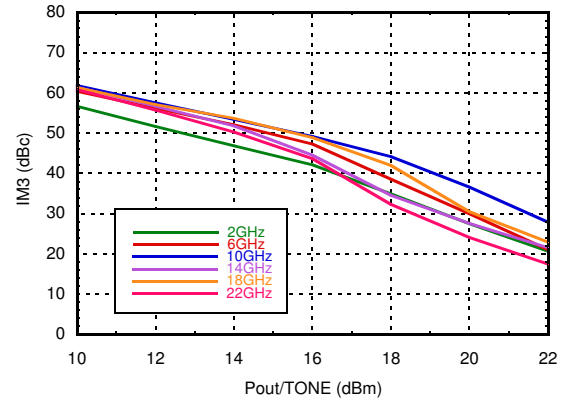

Output IM3 @ Vdd = +9 V

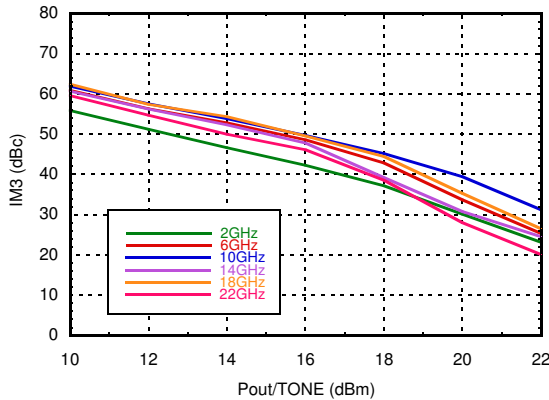

Output IM3 @ Vdd = +10 V

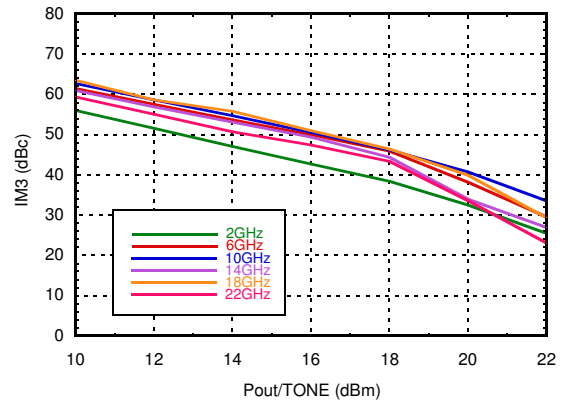

**GaAs pHEMT MMIC
POWER AMPLIFIER, 0.2 - 22 GHz**

Output IM3 @ Vdd = +11 V

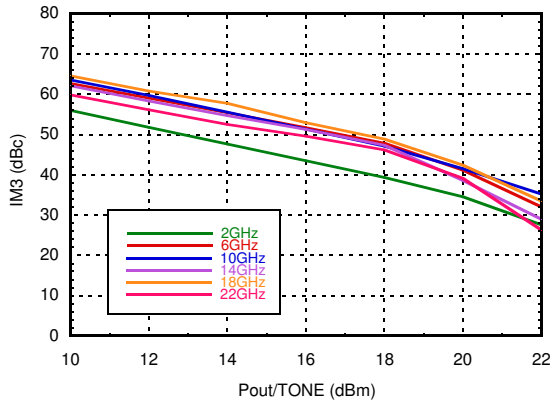

**Second Harmonics vs. Temperature
@ Pout = +16 dBm**

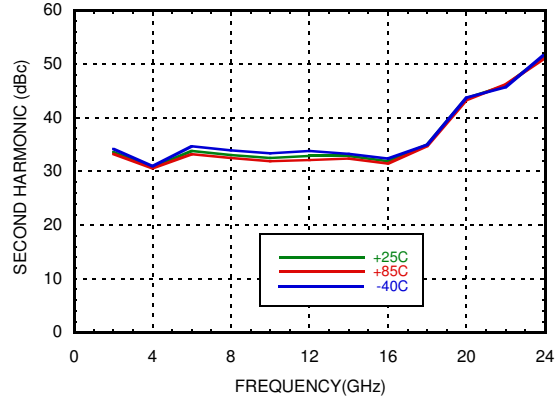

**Second Harmonics vs. Vdd
@ Pout = +16 dBm**

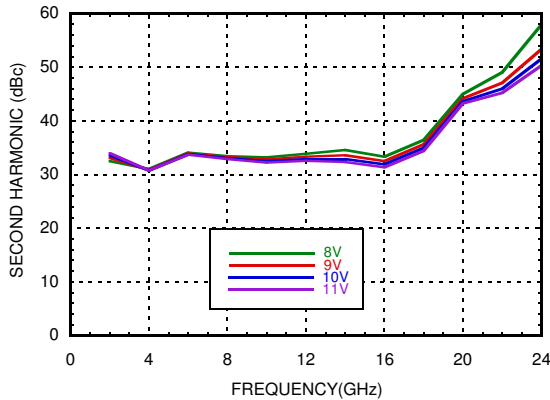

Second Harmonics vs. Pout @ Vdd = 10V

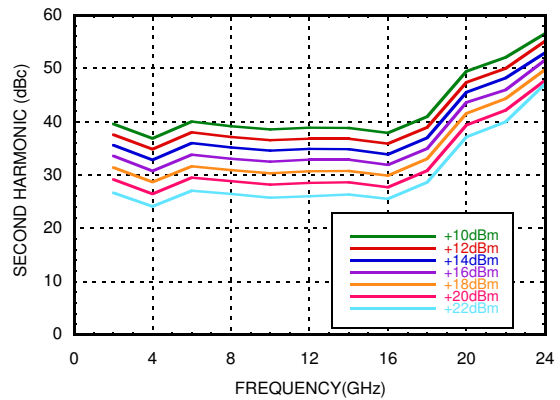

**Low Frequency OIP2 vs. Temperature
@ Pout/tone = +16 dBm**

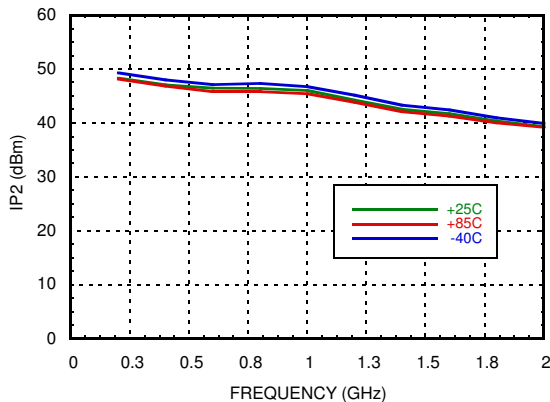

**OIP2 vs. Temperature
@ Pout/tone = +16 dBm**

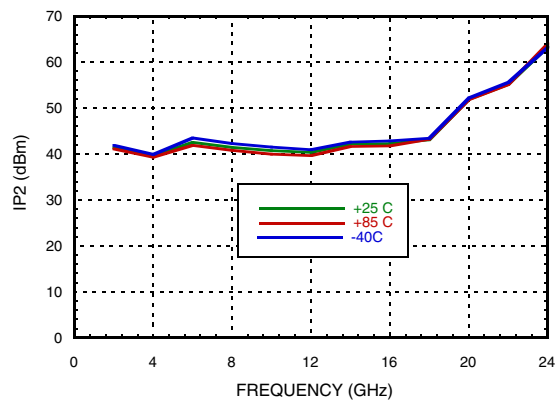

GaAs pHEMT MMIC POWER AMPLIFIER, 0.2 - 22 GHz

OIP2 vs. Vdd
@ Pout/tone = +16 dBm

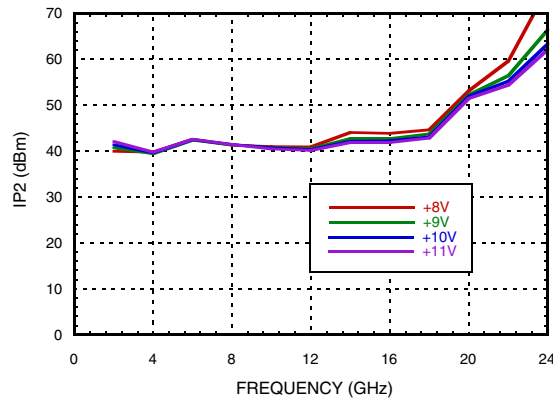

Supply Current vs. Supply Voltage

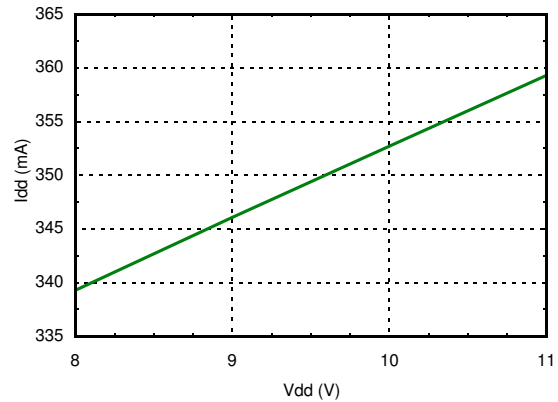

Absolute Maximum Ratings

Nominal Drain Supply to GND	+12.0 V
Continuous P _{diss} (T= 85 °C) (derate 60 mW/°C above 85 °C)	5.4 W
RF Input Power	+25 dBm
Output Load VSWR	7:1
Storage Temperature	-65 to 150 °C
Max Peak Reflow Temperature	260 °C
ESD Sensitivity (HBM)	Class 1A, passed 250V

Reliability Information

Maximum Junction Temperature	175 °C
Nominal Junction Temperature (T=85 °C, Vdd = 10 V)	143.45 °C
Thermal Resistance (channel to ground paddle)	16.7 °C/W
Operating Temperature	-40 to +85 °C



**ELECTROSTATIC SENSITIVE DEVICE
OBSERVE HANDLING PRECAUTIONS**

Stresses at or above those listed under Absolute Maximum Ratings may cause permanent damage to the product. This is a stress rating only, functional operation of the product at these or any other conditions above those indicated in the operational section of this specification is not implied. Operation beyond the maximum operating conditions for extended periods may affect product reliability.

GaAs pHEMT MMIC POWER AMPLIFIER, 0.2 - 22 GHz

Outline Drawing

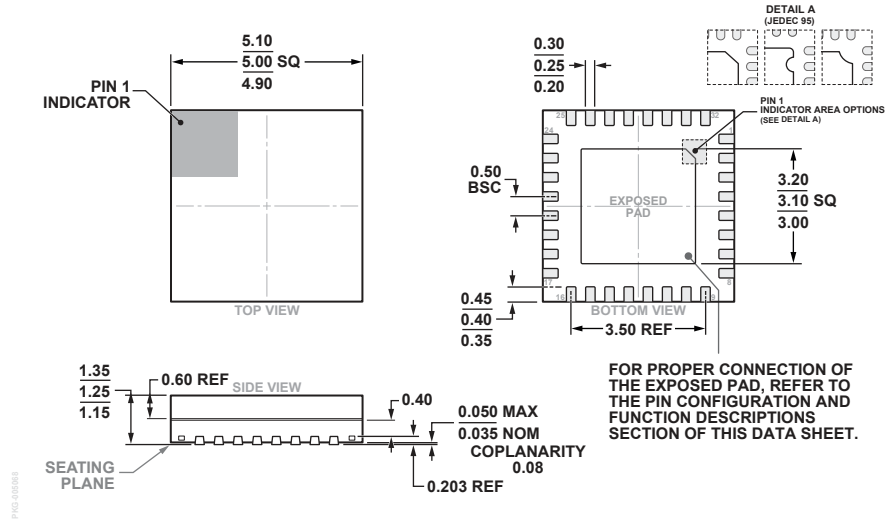

32-Lead Lead Frame Chip Scale Package, Premolded Cavity [LFCSP_CAV]
5 mm x 5 mm Body and 1.25 mm Package Height
(CG-32-2)
Dimensions shown in millimeters

Package Information

Part Number	Package Body Material	Lead Finish	MSL Rating	Package Marking
HMC907APM5E	RoHS-compliant Low Stress Pre-Molded Plastic	NiPdAu	MSL3 [1]	HMC907A
HMC907APM5ETR	RoHS-compliant Low Stress Pre-Molded Plastic	NiPdAu	MSL3 [1]	HMC907A

[1] Max peak reflow temperature of 260 °C

Pin Descriptions

Pin Number	Function	Description	Interface Schematic
1, 4, 6, 8, 9, 16, 17, 20, 22, 24, 25, 32 Package Bottom	GND	These pins & exposed ground paddle must be connected to RF/DC ground.	
2 - 3, 7, 10 - 15, 18 - 19, 23, 26 - 31	N/C	No connection required. These pins may be connected to RF/DC ground without affecting performance.	
5	RFIN	This pad is AC coupled and matched to 50 Ohms.	
21	RFOUT & VDD	RF output for amplifier. Connect DC bias (Vdd) network to provide drain current (Idd). See application circuit herein.	

GaAs pHEMT MMIC POWER AMPLIFIER, 0.2 - 22 GHz

Evaluation PCB

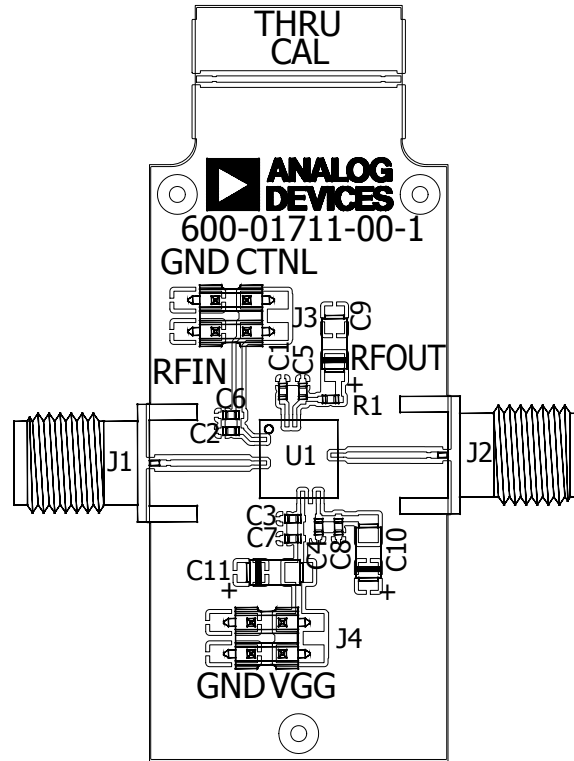

Evaluation Order Information

Item	Contents	Part Number
Evaluation PCB only	HMC907APM5E Evaluation PCB	EV1HMC907APM5 ^[1]
[1] Reference this number when ordering Evaluation PCB Only		

List of Materials for Evaluation Board EV1HMC907APM5

Item	Description
J1, J2	PCB Mount K Connectors
U1	HMC907APM5E Power Amplifier
PCB [1]	600-01711-00 Evaluation PCB

[1] Circuit Board Material: Rogers 4350 or Arlon FR4

The circuit board used in the application should use RF circuit design techniques. Signal lines should have 50 Ohm impedance while the package ground leads and exposed paddle should be connected directly to the ground plane similar to that shown. A sufficient number of via holes should be used to connect the top and bottom ground planes. The evaluation board should be mounted to an appropriate heat sink. The evaluation circuit board shown is available from Analog Devices, Inc.

**GaAs pHEMT MMIC
POWER AMPLIFIER, 0.2 - 22 GHz**

Application Circuit

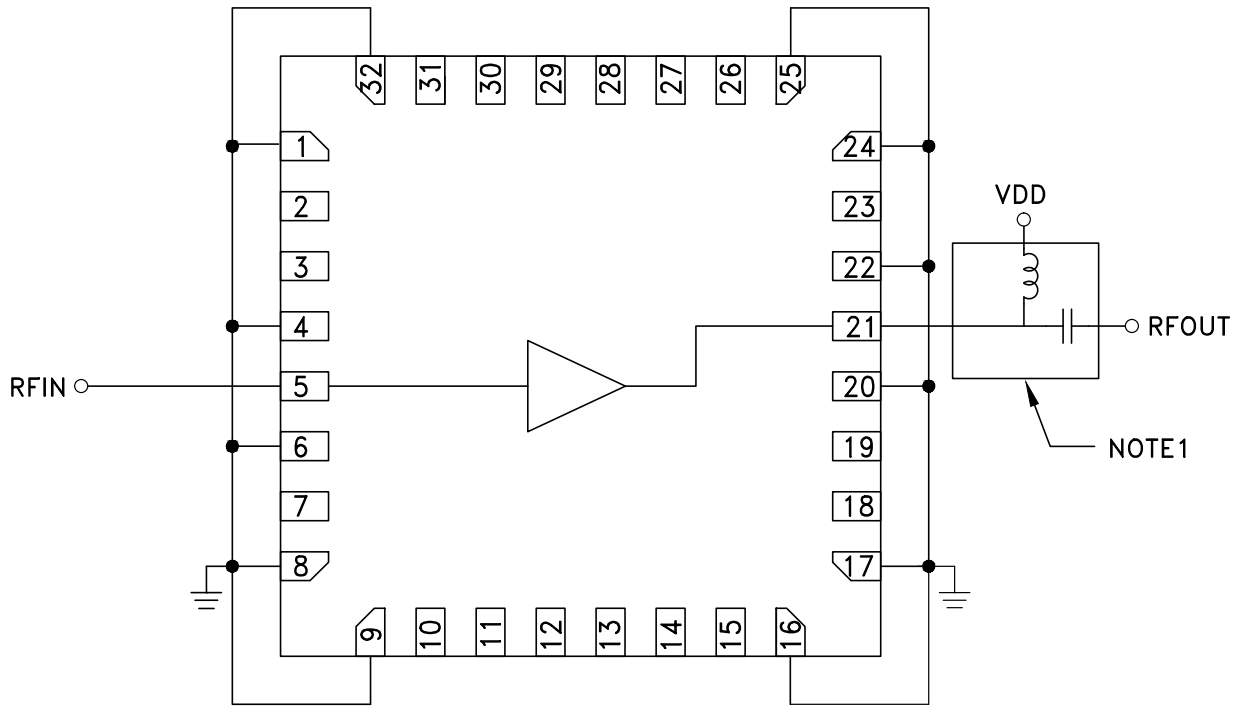

NOTE 1: Drain Bias (Vdd) must be applied through a broadband bias tee or external bias network.