



Parameter	Ratings	Units
Blocking Voltage	60	$V_P$
Load Current	2.2	$A_{rms} / A_{DC}$
On-Resistance (max)	0.15	$\Omega$

### Features

- 3750V<sub>rms</sub> Input/Output Isolation
- Low Drive Power Requirements
- Greater Reliability than Electromechanical Relays
- No EMI/RFI Generation
- Small 6-Pin Package
- Flammability Rating UL 94 V-0
- Surface Mount and Tape & Reel Version Available

### Applications

- Instrumentation
- Multiplexers
- Data Acquisition
- Electronic Switching
- I/O Subsystems
- Meters (Watt-Hour, Water, Gas)
- Medical Equipment—Patient/Equipment Isolation
- Security
- Industrial Controls

### Description

The LCA715 is a 60V single-pole, normally open (1-Form-A) Solid State Relay. It uses optically coupled MOSFET technology to provide 3750V<sub>rms</sub> of input to output isolation, and features an ultra-low on-resistance for high-current operation.

Its optically coupled outputs, which use the patented OptoMOS architecture, are controlled by a highly efficient infrared LED.

Offering the superior reliability associated with semiconductor devices, the LCA715 can be used to replace mechanical relays. Because it has no moving parts, it can offer faster, bounce-free switching in a more compact surface mount or thru-hole package.

### Approvals

- UL Recognized Component: File # E76270
- TUV EN 62368-1: Certificate # B 082667 0008

### Ordering Information

Part #	Description
LCA715	6 Pin DIP (50/Tube)
LCA715S	6 Pin Surface Mount (50/Tube)
LCA715STR	6 Pin Surface Mount (1000/Reel)

### Pin Configuration

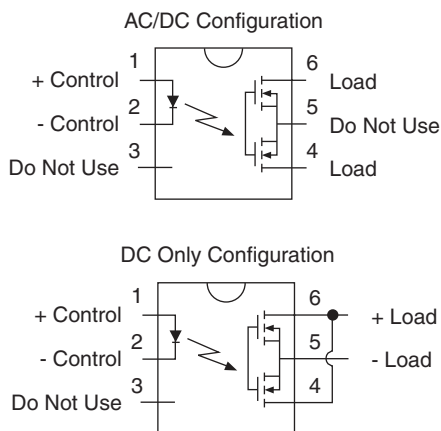

### Switching Characteristics of Normally Open Devices

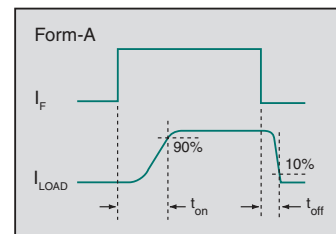

**Absolute Maximum Ratings @ 25°C**

Parameter	Ratings	Units
Blocking Voltage	60	V <sub>p</sub>
Reverse Input Voltage	5	V
Input Control Current Peak (10ms)	50	mA
	1	A
Input Power Dissipation <sup>1</sup>	70	mW
Total Power Dissipation <sup>2</sup>	800	mW
ESD, Human Body Model	8	kV
Isolation Voltage, Input to Output	3750	V <sub>rms</sub>
Operational Temperature, Ambient	-40 to +85	°C
Storage Temperature	-40 to +125	°C

Absolute Maximum Ratings are stress ratings. Stresses in excess of these ratings can cause permanent damage to the device. Functional operation of the device at conditions beyond those indicated in the operational sections of this data sheet is not implied.

Typical values are characteristic of the device at +25°C, and are the result of engineering evaluations. They are provided for information purposes only, and are not part of the manufacturing testing requirements.

<sup>1</sup> Derate input power linearly by 1.33 mW / °C.

<sup>2</sup> Derate output power linearly 6.67 mW / °C.

**Electrical Characteristics @ 25°C**

Parameter	Conditions	Symbol	Min	Typ	Max	Units	
<b>Output Characteristics</b>							
Blocking Voltage	I <sub>L</sub> =1μA	V <sub>DRM</sub>	60	-	-	V <sub>p</sub>	
Load Current Continuous, AC/DC Configuration Continuous, DC Configuration Peak	Free Air	I <sub>L</sub>	-	-	2.2	A <sub>rms</sub> / A <sub>DC</sub>	
			-	-	4	A <sub>DC</sub>	
	t≤10ms	I <sub>LPK</sub>	-	-	±10	A <sub>p</sub>	
On-Resistance <sup>1</sup> AC/DC Configuration DC Configuration	I <sub>F</sub> =5mA, I <sub>L</sub> =1A	R <sub>ON</sub>	-	0.12	0.15	Ω	
			-	0.038	0.05		
Off-State Leakage Current	I <sub>F</sub> =0mA, V <sub>L</sub> =60V <sub>p</sub>	I <sub>LEAK</sub>	-	-	1	μA	
<b>Switching Speeds</b>							
Turn-On Turn-Off	I <sub>F</sub> =5mA, V <sub>L</sub> =10V	t <sub>on</sub>	-	0.7	2.5	ms	
		t <sub>off</sub>	-	0.115	0.25	ms	
Output Capacitance	I <sub>F</sub> =0mA, f=1MHz	C <sub>OUT</sub>	-	110	200	pF	
			V <sub>L</sub> =10V	-	60		-
			V <sub>L</sub> =50V	-	-		-
<b>Input Characteristics</b>							
Input Control Current to Activate	I <sub>L</sub> =1A	I <sub>F</sub>	-	0.9	5	mA	
Input Control Current to Deactivate	-	I <sub>F</sub>	0.4	-	-	mA	
Input Voltage Drop	I <sub>F</sub> =5mA	V <sub>F</sub>	0.9	1.36	1.5	V	
Reverse Input Current	V <sub>R</sub> =5V	I <sub>R</sub>	-	-	10	μA	
<b>Common Characteristics</b>							
Input to Output Capacitance	V <sub>IO</sub> =0V, f=1MHz	C <sub>IO</sub>	-	3	-	pF	

<sup>1</sup> Measurement taken within 1 second of on-time.

**PERFORMANCE DATA\***

**Typical LED Forward Voltage Drop**  
(N=50,  $I_F=5\text{mA}$ )

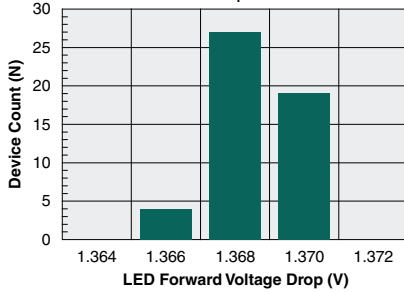

**Typical Turn-On Time Distribution**  
(N=50,  $I_F=5\text{mA}$ ,  $I_L=100\text{mA}$ )

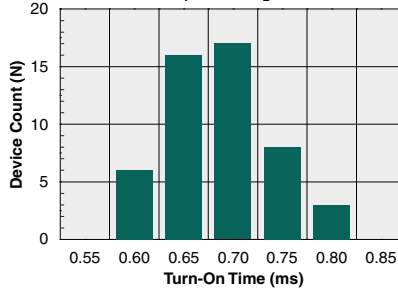

**Typical Turn-Off Time Distribution**  
(N=50,  $I_F=5\text{mA}$ ,  $I_L=100\text{mA}$ )

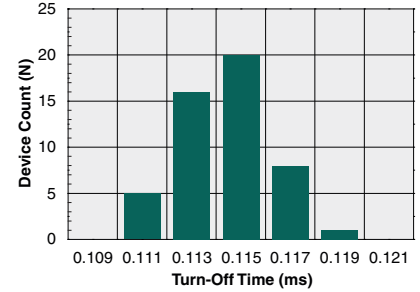

**Typical  $I_F$  for Switch Operation**  
(N=50,  $I_L=100\text{mA}$ )

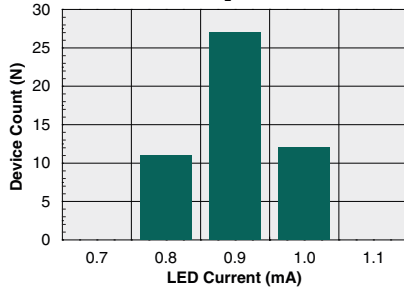

**Typical On-Resistance Distribution**  
(N=50,  $I_F=5\text{mA}$ ,  $I_L=1\text{A}$ )

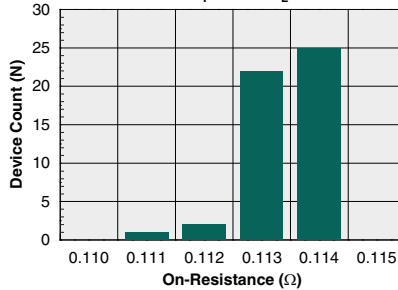

**Typical Blocking Voltage Distribution**  
(N=50)

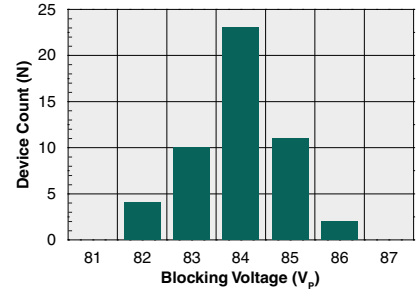

**Typical LED Forward Voltage Drop vs. Temperature**

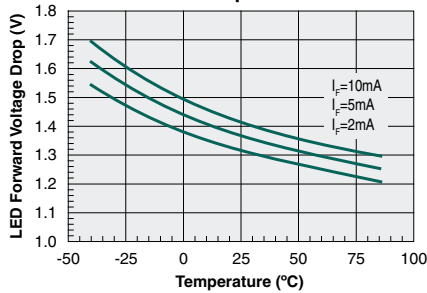

**Typical Turn-On Time vs. LED Forward Current**  
( $I_L=100\text{mA}$ )

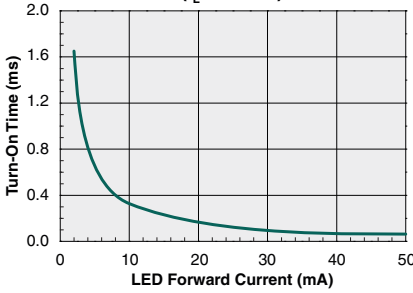

**Typical Turn-Off Time vs. LED Forward Current**  
( $I_L=100\text{mA}$ )

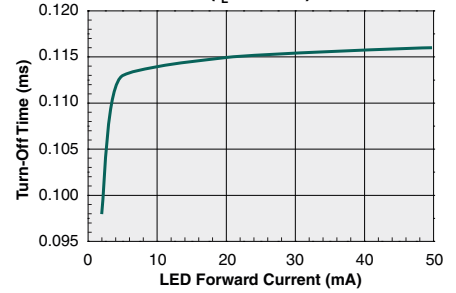

**LED Current to Operate vs. Temperature**  
( $I_L=1\text{A}$ )

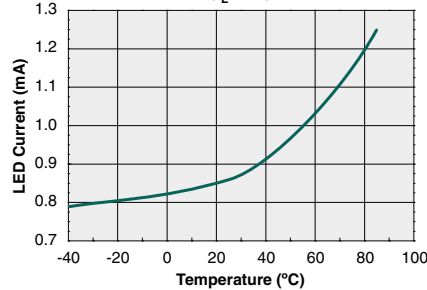

**Turn-On Time vs. Temperature**  
( $I_L=100\text{mA}$ )

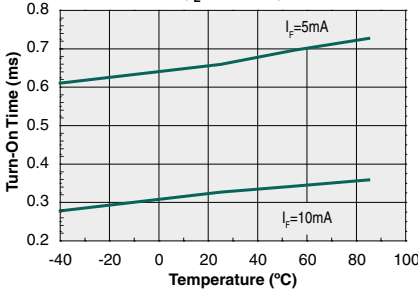

**Turn-Off Time vs. Temperature**  
( $I_L=100\text{mA}$ )

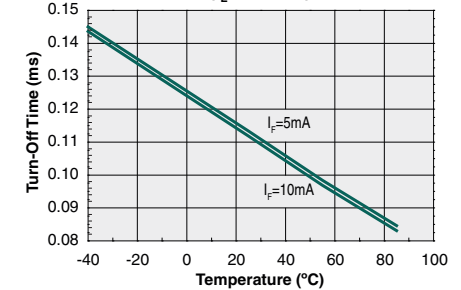

\*Unless otherwise noted, data presented in these graphs is typical of device operation at 25°C.

**PERFORMANCE DATA\***

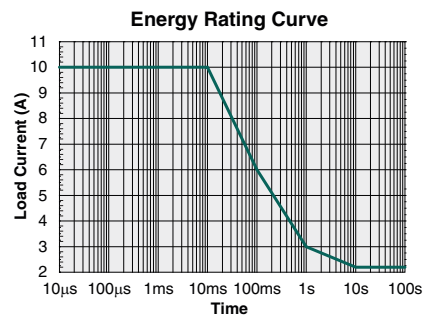
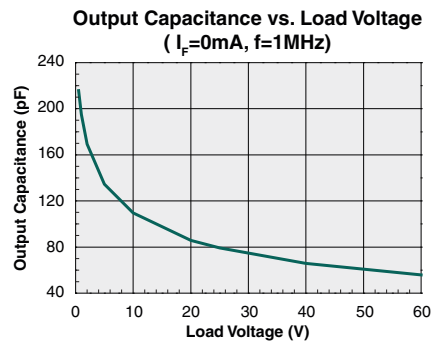
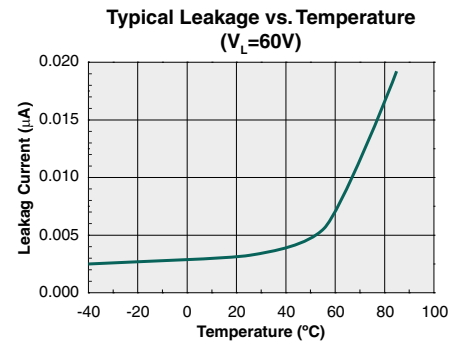
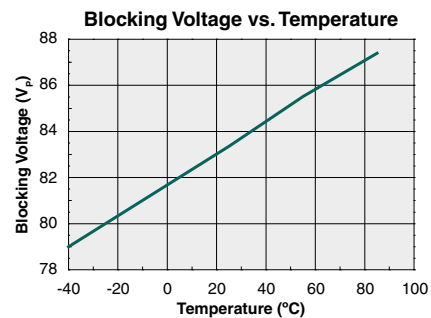
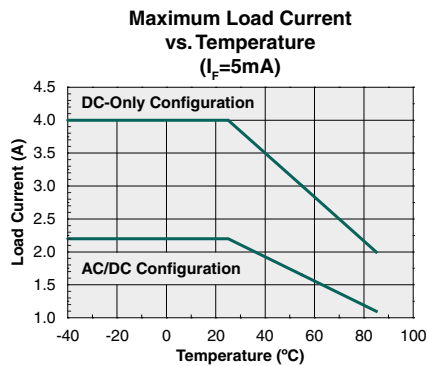
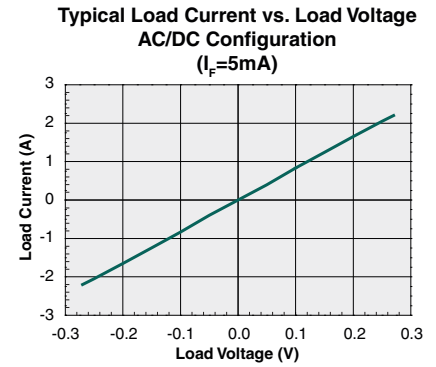
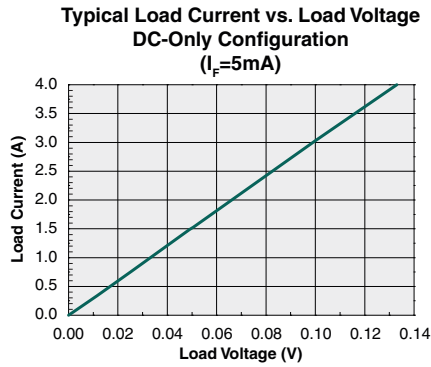
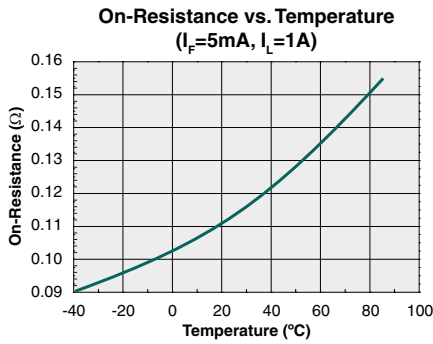

\*Unless otherwise noted, data presented in these graphs is typical of device operation at 25°C.

**Manufacturing Information**

**Moisture Sensitivity**



All plastic encapsulated semiconductor packages are susceptible to moisture ingress. IXYS Integrated Circuits classifies its plastic encapsulated devices for moisture sensitivity according to the latest version of the joint industry standard, **IPC/JEDEC J-STD-020**, in force at the time of product evaluation. We test all of our products to the maximum conditions set forth in the standard, and guarantee proper operation of our devices when handled according to the limitations and information in that standard as well as to any limitations set forth in the information or standards referenced below.

Failure to adhere to the warnings or limitations as established by the listed specifications could result in reduced product performance, reduction of operable life, and/or reduction of overall reliability.

This product carries a **Moisture Sensitivity Level (MSL)** classification as shown below, and should be handled according to the requirements of the latest version of the joint industry standard **IPC/JEDEC J-STD-033**.

Device	Moisture Sensitivity Level (MSL) Classification
LCA715S	MSL 1

**ESD Sensitivity**



This product is ESD Sensitive, and should be handled according to the industry standard **JESD-625**.

**Soldering Profile**

Provided in the table below is the **IPC/JEDEC J-STD-020** Classification Temperature ( $T_C$ ) and the maximum total dwell time ( $t_p$ ) in all reflow processes that the body temperature of these surface mount devices may be ( $T_C - 5$ )°C or greater. The device's body temperature must not exceed the Classification Temperature at any time during reflow soldering processes.

Device	Classification Temperature ( $T_C$ )	Dwell Time ( $t_p$ )	Max Reflow Cycles
LCA715S	250°C	30 seconds	3

For through-hole devices, the maximum pin temperature and maximum dwell time through all solder waves is provided in the table below. Dwell time is the interval beginning when the pins are initially immersed into the solder wave until they exit the solder wave. For multiple waves, the dwell time is from entering the first wave until exiting the last wave. During this time, pin temperatures must not exceed the maximum temperature given in the table below. Body temperature of the device must not exceed the limit shown in the table below at any time during the soldering process.

Device	Maximum Pin Temperature	Maximum Body Temperature	Maximum Dwell Time	Wave Cycles
LCA715	260°C	250°C	10 seconds*	1

\*Total cumulative duration of all waves.

**Board Wash**

IXYS Integrated Circuits recommends the use of no-clean flux formulations. Board washing to reduce or remove flux residue following the solder reflow process is acceptable provided proper precautions are taken to prevent damage to the device. These precautions include but are not limited to: using a low pressure wash and providing a follow up bake cycle sufficient to remove any moisture trapped within the device due to the washing process. Due to the variability of the wash parameters used to clean the board, determination of the bake temperature and duration necessary to remove the moisture trapped within the package is the responsibility of the user (assembler). Cleaning or drying methods that employ ultrasonic energy may damage the device and should not be used. Additionally, the device must not be exposed to halide flux or solvents.



**MECHANICAL DIMENSIONS**

**LCA715**

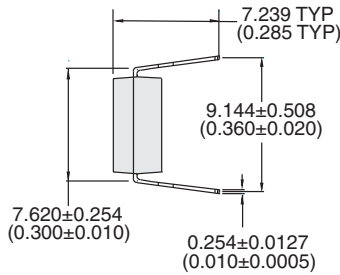
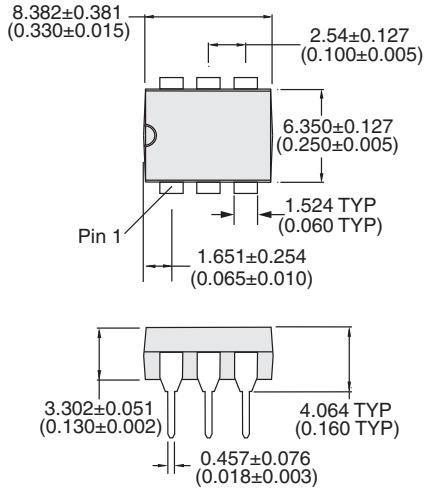

**PCB Hole Pattern**

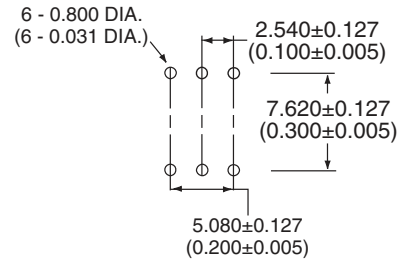

Controlling dimension: inches

Dimensions  
mm  
(inches)

**LCA715S**

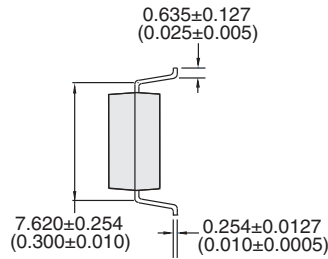
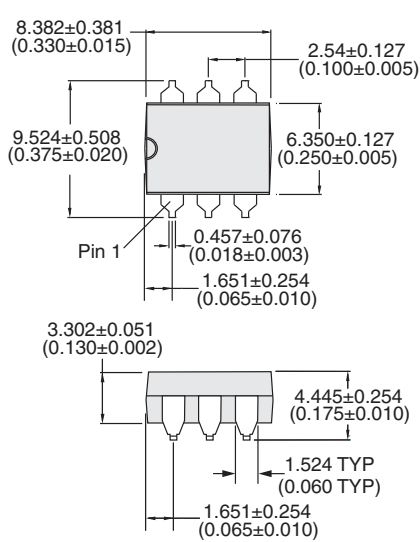

**PCB Land Pattern**

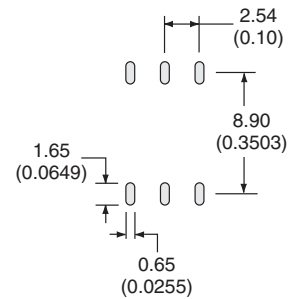

Controlling dimension: inches

Dimensions  
mm  
(inches)

**LCA715STR Tape & Reel**

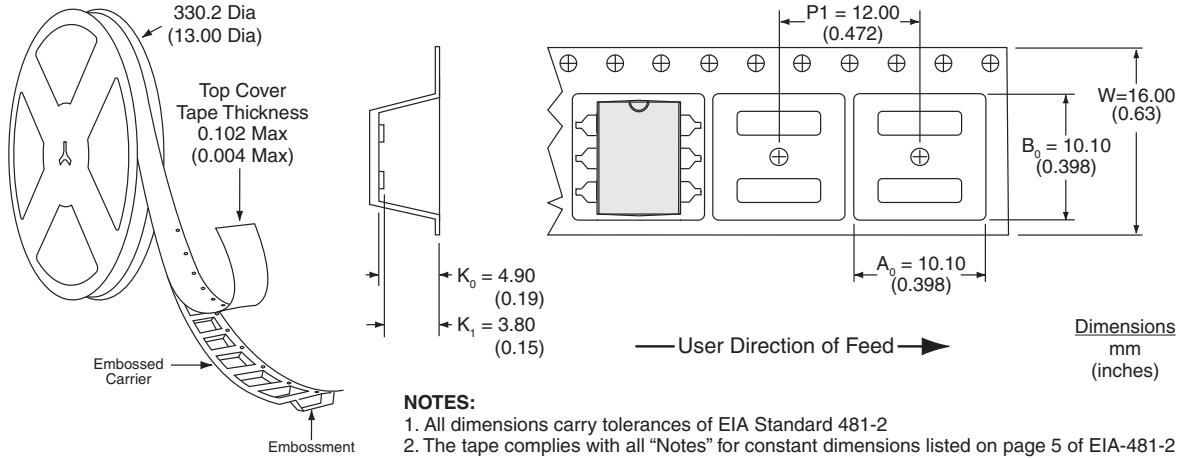

For additional information please visit our website at: <https://www.ixysic.com>



Disclaimer Notice - Information furnished is believed to be accurate and reliable. However, users should independently evaluate the suitability of and test each product selected for their own applications. Littelfuse products are not designed for, and may not be used in, all applications. Read complete Disclaimer Notice at <https://www.littelfuse.com/disclaimer-electronics>.

Specification: DS-LCA715-R08  
©Copyright 2021, Littelfuse, Inc.  
All rights reserved. Printed in USA.  
11/2/2021