

MS256-10*

DRAWN-SEAMLESS EMI/RFI SHIELD

*OPTIONAL SHIELD CONFIGURATIONS

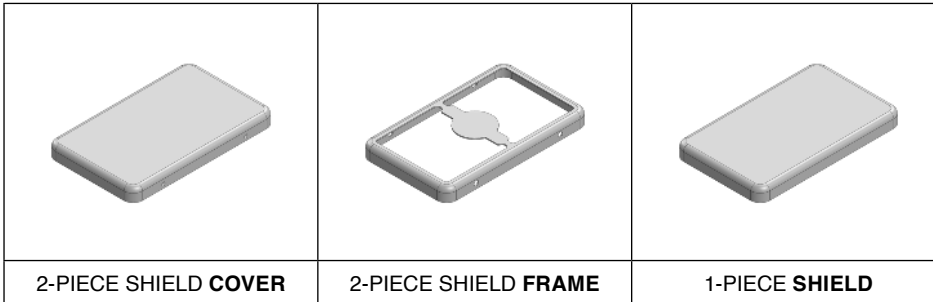

| ITEM P/N | ITEM DESCRIPTION | MATERIAL |
|------------------------------|-------------------------------------|------------------|
| MS256-10C | 2-PIECE EMI/RFI SHIELD COVER | TIN-PLATED STEEL |
| MS256-10F | 2-PIECE EMI/RFI SHIELD FRAME | TIN-PLATED STEEL |
| MS256-10S | 1-PIECE EMI/RFI SHIELD | TIN-PLATED STEEL |
| MS256-10C-NS | 2-PIECE EMI/RFI SHIELD COVER | NICKEL-SILVER |
| MS256-10F-NS | 2-PIECE EMI/RFI SHIELD FRAME | NICKEL-SILVER |
| MS256-10S-NS | 1-PIECE EMI/RFI SHIELD | NICKEL-SILVER |

TIN-PLATED STEEL: CRS ELECTROLYTIC TINPLATE

NICKEL-SILVER: UNS C77000 / UNS C73500



SHIELD CONFIGURATION:

MATERIAL:

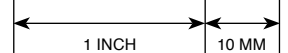

© MASACH TECH LTD.
 22 HAGANAN, MODIIN 7169513 ISRAEL
 T: (+972) 8-9754681 / F: (+972) 8-9754682
info@masach.com / www.masach.com

SHIELD TYPE:



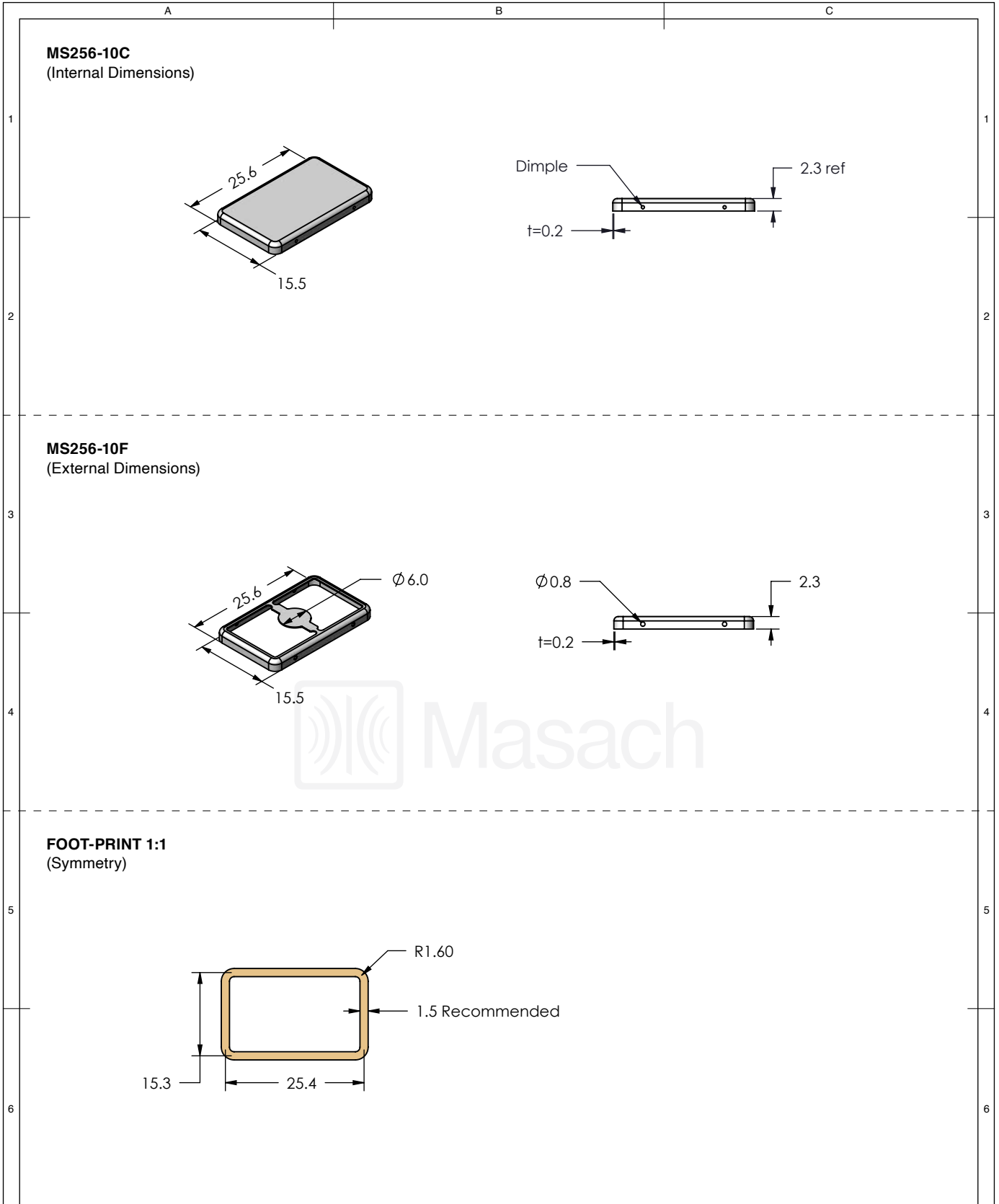

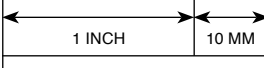

MMGS / PRINT 1:1 / A4

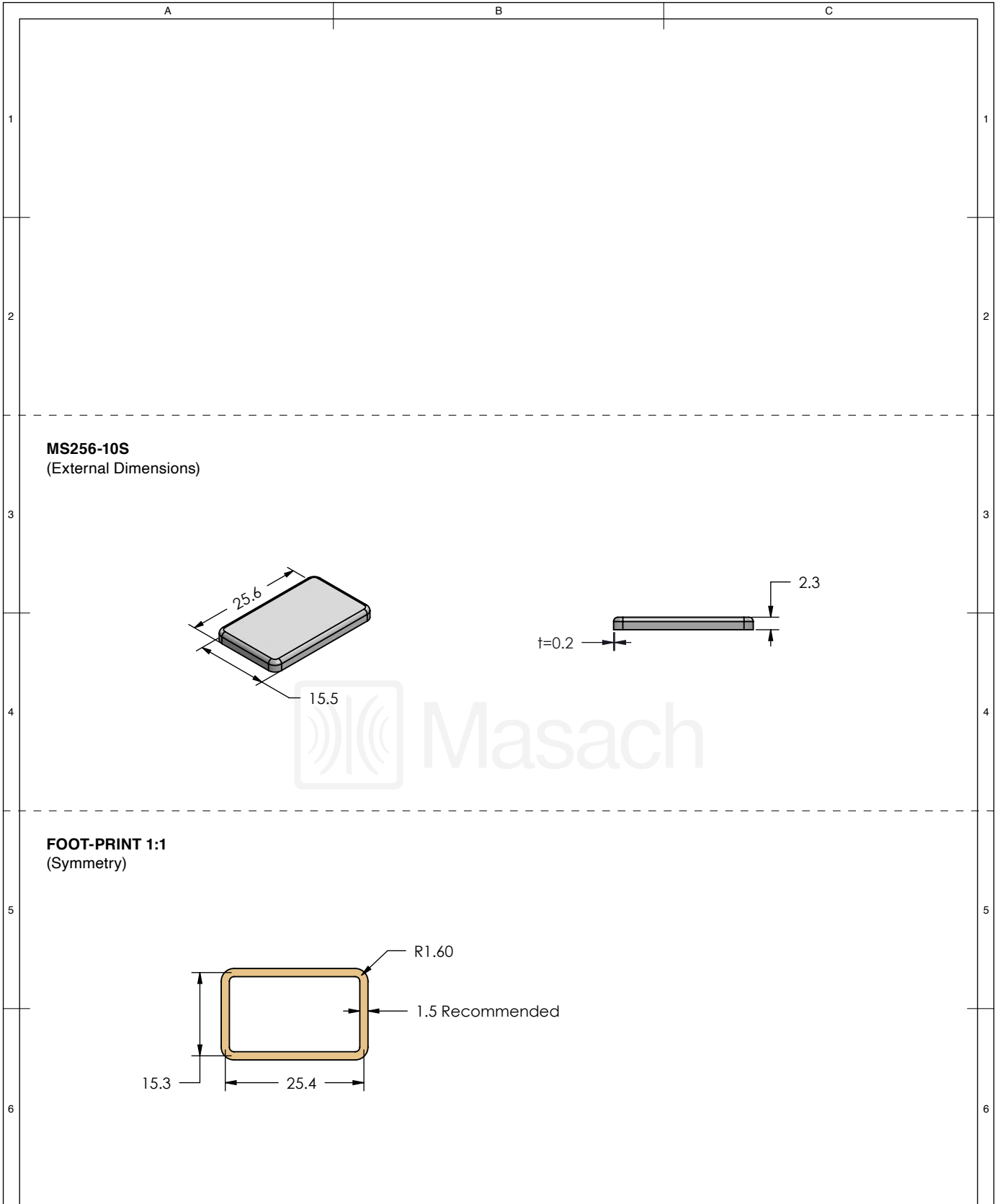

| | | | | |
|---|--|--|---|---|
|  | SHIELD CONFIGURATION: | | MATERIAL: | |
| | 2-PIECE EM/RFI SHIELD | | TIN-PLATED STEEL ⁽¹⁾ | |
| | NOTE: (1) CRS ELECTROLYTIC TINPLATE (2) GENERAL TOLERANCE (+/-) 0.2MM | | | |
| © MASACH TECH LTD. 22 HAGANAN, MODIIN 7169513 ISRAEL T: (+972) 8-9754681 / F: (+972) 8-9754682 info@masach.com / www.masach.com | SHIELD TYPE: | |   |  |
| | DRAWN-SEAMLESS EM/RFI SHIELD | | | |



This product has been designed and manufactured by © Masach Tech Ltd. The use of this product in any type of electronic device or application is not under Masach Tech Ltd. liability.

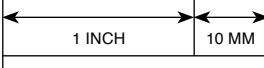

| | | |
|---|-------------------------------------|---|
|  | SHIELD CONFIGURATION: | MATERIAL: |
| | 1-PIECE EM/RFI SHIELD | TIN-PLATED STEEL ⁽¹⁾ |
| NOTE: (1) CRS ELECTROLYTIC TINPLATE (2) GENERAL TOLERANCE (+/-) 0.2MM | | |
| © MASACH TECH LTD. 22 HAGANAN, MODIIN 7169513 ISRAEL T: (+972) 8-9754681 / F: (+972) 8-9754682 info@masach.com / www.masach.com | SHIELD TYPE: |   |
| | DRAWN-SEAMLESS EM/RFI SHIELD |  |
| | | MMGS / PRINT 1:1 / A4 |

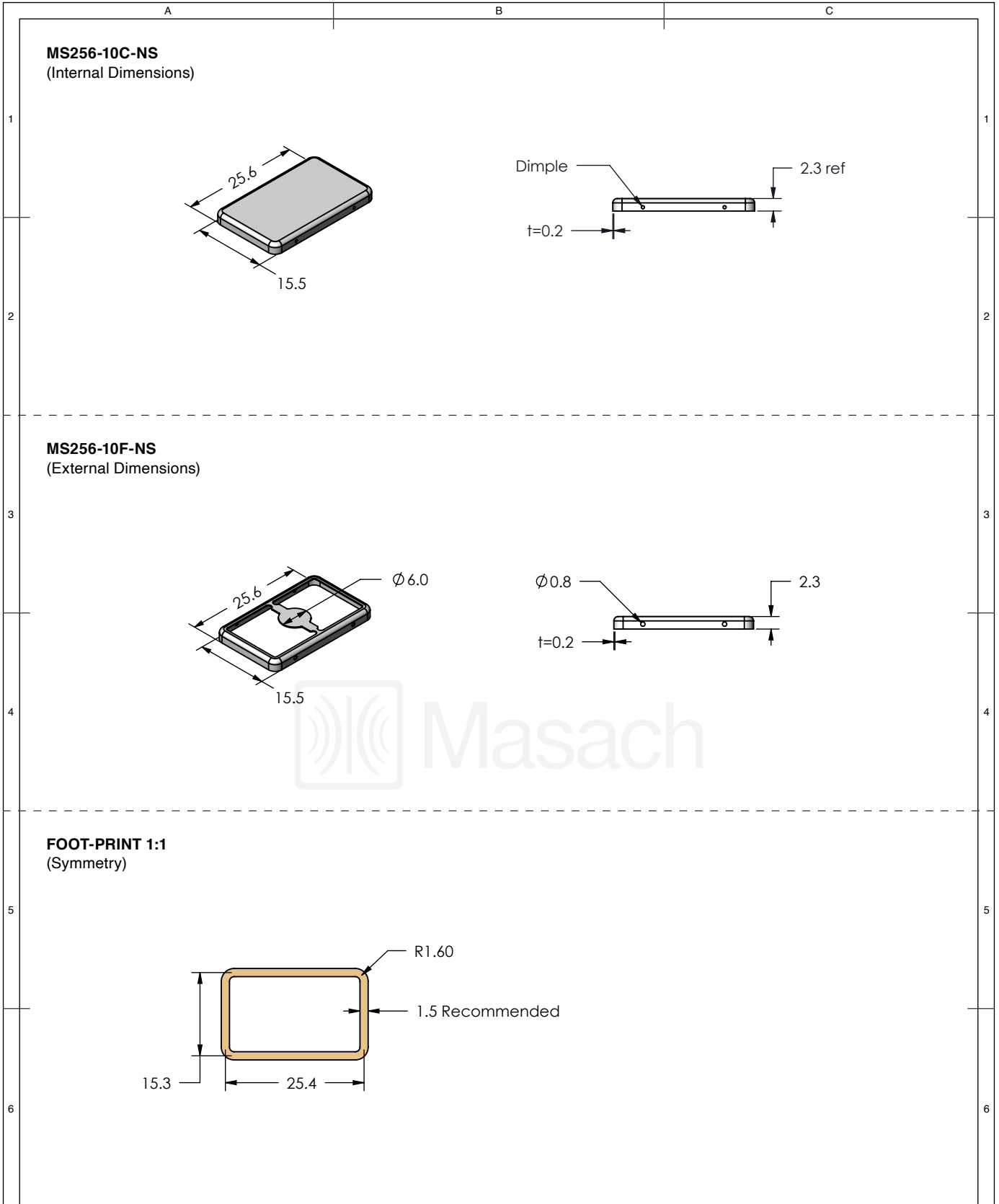

This product has been designed and manufactured by © Masach Tech Ltd. The use of this product in any type of electronic device or application is not under Masach Tech Ltd. liability.

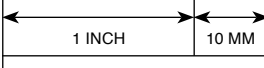

| | | | | |
|---|--|--|---|---|
|  | SHIELD CONFIGURATION: | | MATERIAL: | |
| | 2-PIECE EM/RFI SHIELD | | NICKEL-SILVER ⁽¹⁾ | |
| | NOTE: (1) UNS C77000 / UNS C73500 (2) GENERAL TOLERANCE (+/-) 0.2MM | | | |
| © MASACH TECH LTD. 22 HAGANAN, MODIIN 7169513 ISRAEL T: (+972) 8-9754681 / F: (+972) 8-9754682 info@masach.com / www.masach.com | SHIELD TYPE: | |   |  |
| | DRAWN-SEAMLESS EM/RFI SHIELD | | | |

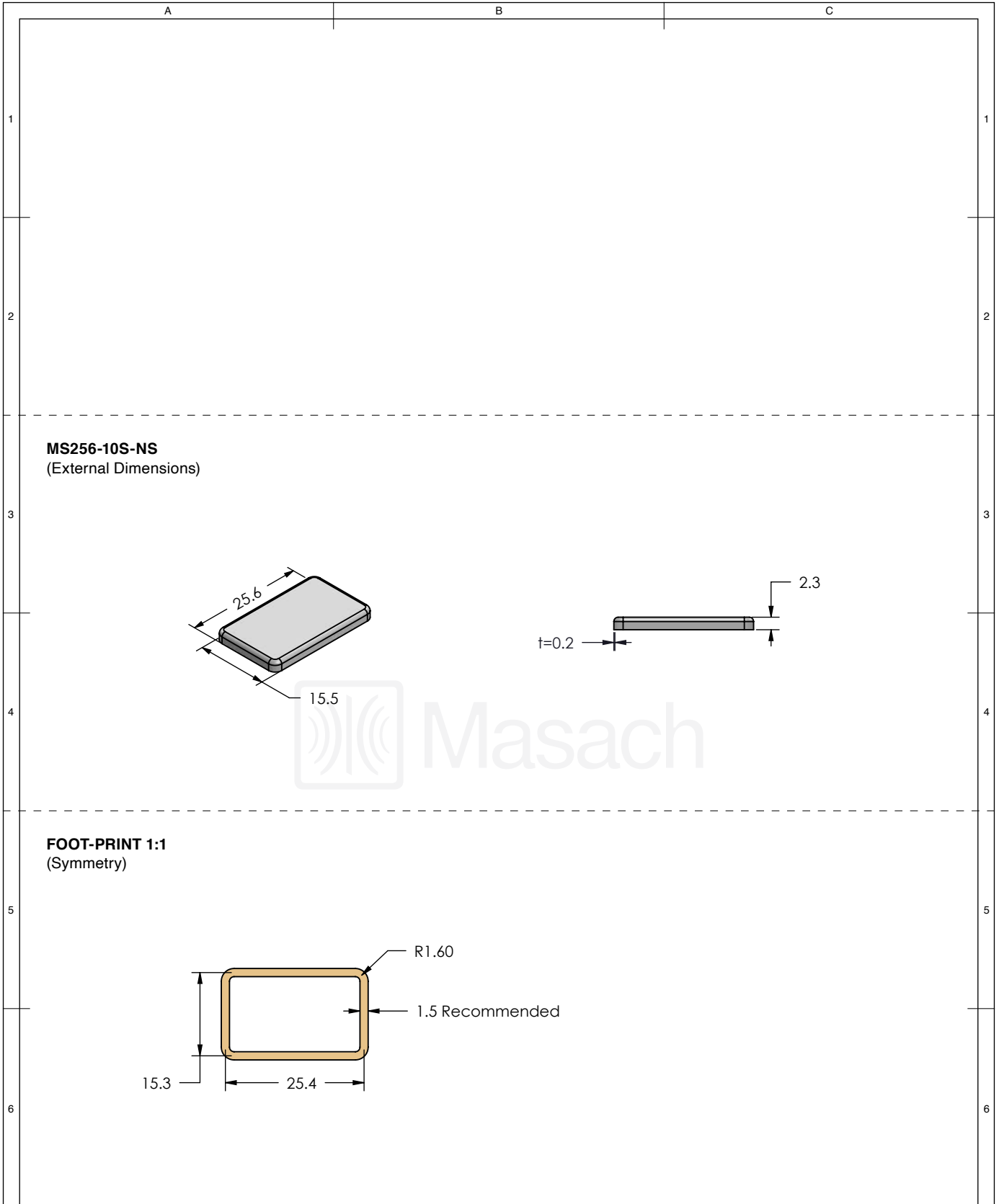
This product has been designed and manufactured by © Masach Tech Ltd. The use of this product in any type of electronic device or application is not under Masach Tech Ltd. liability.

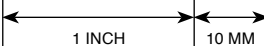

| | | | | |
|---|-------------------------------------|--|---|---|
|  | SHIELD CONFIGURATION: | | MATERIAL: | |
| | 1-PIECE EM/RFI SHIELD | | NICKEL-SILVER ⁽¹⁾ | |
| NOTE: (1) UNS C77000 / UNS C73500 (2) GENERAL TOLERANCE (+/-) 0.2MM | | | | |
| © MASACH TECH LTD. 22 HAGANAN, MODIIN 7169513 ISRAEL T: (+972) 8-9754681 / F: (+972) 8-9754682 info@masach.com / www.masach.com | SHIELD TYPE: | |   |  |
| | DRAWN-SEAMLESS EM/RFI SHIELD | | | |

This product has been designed and manufactured by © Masach Tech Ltd. The use of this product in any type of electronic device or application is not under Masach Tech Ltd. liability.

A

B

C

MS256-10* SMT/SMD PACKING TRAY

* COMPATIBLE TO ALL SHIELD CONFIGURATIONS

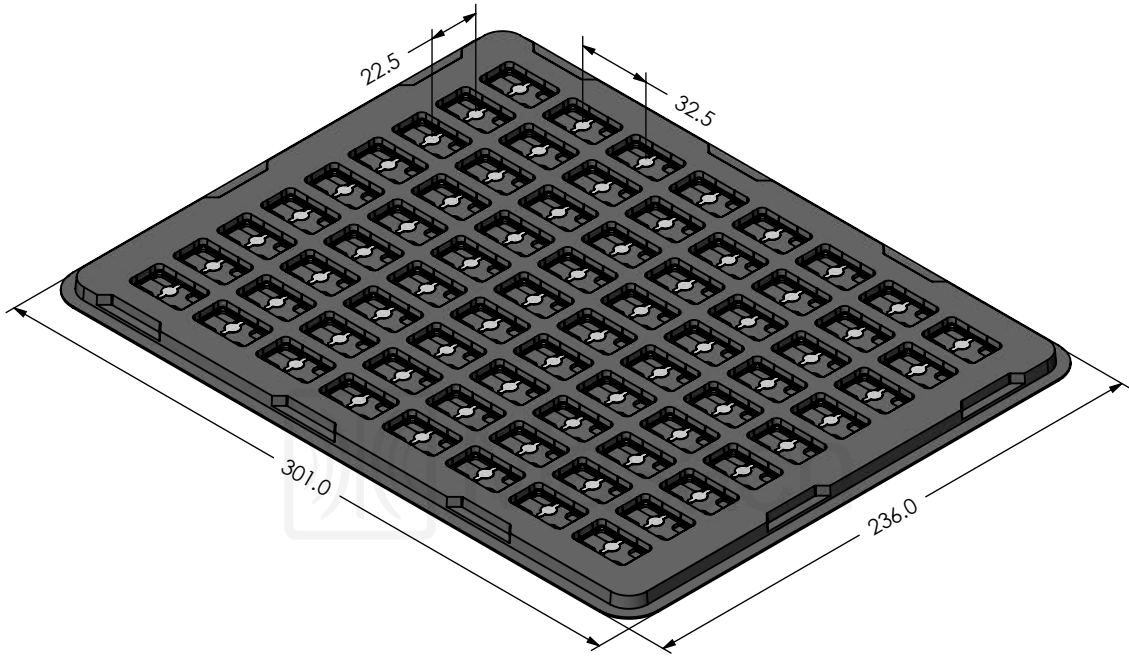

1

1

2

2

3

3

4

4

5

5

6

6



SHIELD CONFIGURATION:

MATERIAL:

© MASACH TECH LTD.
 22 HAGANAN, MODIIN 7169513 ISRAEL
 T: (+972) 8-9754681 / F: (+972) 8-9754682
info@masach.com / www.masach.com

SHIELD TYPE:

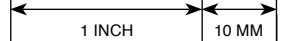

MMGS / PRINT 1:1 / A4

This product has been designed and manufactured by © Masach Tech Ltd. The use of this product in any type of electronic device or application is not under Masach Tech Ltd. liability.