

ON Semiconductor

Is Now

onsemi™

To learn more about onsemi™, please visit our website at
www.onsemi.com

onsemi and **onsemi** and other names, marks, and brands are registered and/or common law trademarks of Semiconductor Components Industries, LLC dba "**onsemi**" or its affiliates and/or subsidiaries in the United States and/or other countries. **onsemi** owns the rights to a number of patents, trademarks, copyrights, trade secrets, and other intellectual property. A listing of **onsemi** product/patent coverage may be accessed at www.onsemi.com/site/pdf/Patent-Marking.pdf. **onsemi** reserves the right to make changes at any time to any products or information herein, without notice. The information herein is provided "as-is" and **onsemi** makes no warranty, representation or guarantee regarding the accuracy of the information, product features, availability, functionality, or suitability of its products for any particular purpose, nor does **onsemi** assume any liability arising out of the application or use of any product or circuit, and specifically disclaims any and all liability, including without limitation special, consequential or incidental damages. Buyer is responsible for its products and applications using **onsemi** products, including compliance with all laws, regulations and safety requirements or standards, regardless of any support or applications information provided by **onsemi**. "Typical" parameters which may be provided in **onsemi** data sheets and/or specifications can and do vary in different applications and actual performance may vary over time. All operating parameters, including "Typicals" must be validated for each customer application by customer's technical experts. **onsemi** does not convey any license under any of its intellectual property rights nor the rights of others. **onsemi** products are not designed, intended, or authorized for use as a critical component in life support systems or any FDA Class 3 medical devices or medical devices with a same or similar classification in a foreign jurisdiction or any devices intended for implantation in the human body. Should Buyer purchase or use **onsemi** products for any such unintended or unauthorized application, Buyer shall indemnify and hold **onsemi** and its officers, employees, subsidiaries, affiliates, and distributors harmless against all claims, costs, damages, and expenses, and reasonable attorney fees arising out of, directly or indirectly, any claim of personal injury or death associated with such unintended or unauthorized use, even if such claim alleges that **onsemi** was negligent regarding the design or manufacture of the part. **onsemi** is an Equal Opportunity/Affirmative Action Employer. This literature is subject to all applicable copyright laws and is not for resale in any manner. Other names and brands may be claimed as the property of others.



ON Semiconductor®

FGB20N60SFD-F085

600V, 20A Field Stop IGBT

Features

- High current capability
- Low saturation voltage: $V_{CE(sat)} = 2.2V @ I_C = 20A$
- High input impedance
- Fast switching
- Qualified to Automotive Requirements of AEC-Q101
- RoHS compliant

Applications

- Inverters, SMPS, PFC, UPS
- Automotive Chargers, Converters, High Voltage Auxiliaries

General Description

Using novel field-stop IGBT technology, ON Semiconductor's new series of field-stop IGBTs offers the optimum performance for automotive chargers, inverters, and other applications where low conduction and switching losses are essential.

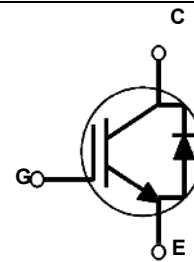
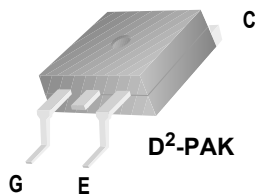

Absolute Maximum Ratings

Symbol	Description	Ratings	Units
V_{CES}	Collector to Emitter Voltage	600	V
V_{GES}	Gate to Emitter Voltage	± 20	V
I_C	Collector Current @ $T_C = 25^\circ C$	40	A
	Collector Current @ $T_C = 100^\circ C$	20	A
$I_{CM(1)}$	Pulsed Collector Current @ $T_C = 25^\circ C$	60	A
I_F	Diode Forward Current @ $T_C = 25^\circ C$	20	A
	Diode Forward Current @ $T_C = 100^\circ C$	10	A
$I_{FM(1)}$	Pulsed Diode Maximum Forward Current	60	A
P_D	Maximum Power Dissipation @ $T_C = 25^\circ C$	208	W
	Maximum Power Dissipation @ $T_C = 100^\circ C$	83	W
T_J	Operating Junction Temperature	-55 to +150	$^\circ C$
T_{stg}	Storage Temperature Range	-55 to +150	$^\circ C$
T_L	Maximum Lead Temp. for soldering Purposes, 1/8" from case for 5 seconds	300	$^\circ C$

Thermal Characteristics

Symbol	Parameter	Ratings	Units
$R_{\theta JC}(IGBT)(2)$	Thermal Resistance, Junction to Case	0.6	$^\circ C/W$
$R_{\theta JC}(Diode)$	Thermal Resistance, Junction to Case	2.6	$^\circ C/W$

Symbol	Parameter	Typ.	Units
$R_{\theta JA}$	Thermal Resistance, Junction to Ambient (PCB Mount)(2)	75	$^\circ C/W$

FGB20N60SFD-F085 600V, 20A Field Stop IGBT

Package Marking and Ordering Information

Device Marking	Device	Package	Packaging Type	Qty per Tube	Max Qty per Box
FGB20N60SFD	FGB20N60SFD-F085	TO-263	Tube	50ea	-

Electrical Characteristics of the IGBT T_C = 25°C unless otherwise noted

Symbol	Parameter	Test Conditions	Min.	Typ.	Max.	Units
Off Characteristics						
V_{CES}	Collector to Emitter Breakdown Voltage	$V_{GE} = 0V, I_C = 250\mu A$	600	-	-	V
$\frac{\Delta V_{CES}}{\Delta T_J}$	Temperature Coefficient of Breakdown Voltage	$V_{GE} = 0V, I_C = 250\mu A$	-	0.79	-	V/°C
I_{CES}	Collector Cut-Off Current	$V_{CE} = V_{CES}, V_{GE} = 0V$	-	-	250	μA
		ICES at 80%*BV _{CES} , 150°C	-	-	250	
I_{GES}	G-E Leakage Current	$V_{GE} = V_{GES}, V_{CE} = 0V$	-	-	±400	nA
On Characteristics						
$V_{GE(th)}$	G-E Threshold Voltage	$I_C = 250\mu A, V_{CE} = V_{GE}$	4.0	4.8	6.5	V
$V_{CE(sat)}$	Collector to Emitter Saturation Voltage	$I_C = 20A, V_{GE} = 15V$	-	2.2	2.85	V
		$I_C = 20A, V_{GE} = 15V, T_C = 125^\circ C$	-	2.4	-	V
Dynamic Characteristics						
C_{ies}	Input Capacitance	$V_{CE} = 30V, V_{GE} = 0V, f = 1MHz$	-	940	1250	pF
C_{oes}	Output Capacitance		-	110	146	pF
C_{res}	Reverse Transfer Capacitance		-	40	53	pF
Switching Characteristics						
$t_{d(on)}$	Turn-On Delay Time	$V_{CC} = 400V, I_C = 20A, R_G = 10\Omega, V_{GE} = 15V, \text{Inductive Load}, T_C = 25^\circ C$	-	10	13	ns
t_r	Rise Time		-	16	21	ns
$t_{d(off)}$	Turn-Off Delay Time		-	90	120	ns
t_f	Fall Time		-	24	36	ns
E_{on}	Turn-On Switching Loss		-	0.31	0.41	mJ
E_{off}	Turn-Off Switching Loss		-	0.13	0.21	mJ
E_{ts}	Total Switching Loss	-	0.44	0.59	mJ	
$t_{d(on)}$	Turn-On Delay Time	$V_{CC} = 400V, I_C = 20A, R_G = 10\Omega, V_{GE} = 15V, \text{Inductive Load}, T_C = 125^\circ C$	-	12	16	ns
t_r	Rise Time		-	16	21	ns
$t_{d(off)}$	Turn-Off Delay Time		-	95	126	ns
t_f	Fall Time		-	28	43	ns
E_{on}	Turn-On Switching Loss		-	0.45	0.60	mJ
E_{off}	Turn-Off Switching Loss		-	0.21	0.38	mJ
E_{ts}	Total Switching Loss	-	0.66	0.88	mJ	
Q_g	Total Gate Charge	$V_{CE} = 400V, I_C = 20A, V_{GE} = 15V$	-	63	95	nC
Q_{ge}	Gate to Emitter Charge		-	7	11	nC
Q_{gc}	Gate to Collector Charge		-	32	48	nC

Electrical Characteristics of the Diode $T_C = 25^\circ\text{C}$ unless otherwise noted

Symbol	Parameter	Test Conditions	Min.	Typ.	Max	Units	
V_{FM}	Diode Forward Voltage	$I_F = 10A$	$T_C = 25^\circ\text{C}$	-	1.9	2.5	V
			$T_C = 125^\circ\text{C}$	-	1.7	-	
t_{rr}	Diode Reverse Recovery Time	$I_{ES} = 10A, dI_{ES}/dt = 200A/\mu\text{s}$	$T_C = 25^\circ\text{C}$	-	111	-	ns
			$T_C = 125^\circ\text{C}$	-	204	-	
Q_{rr}	Diode Reverse Recovery Charge	$I_{ES} = 10A, dI_{ES}/dt = 200A/\mu\text{s}$	$T_C = 25^\circ\text{C}$	-	174	244	nC
			$T_C = 125^\circ\text{C}$	-	463	-	

Notes:

1: Repetitive rating: Pulse width limited by max. junction temperature

2: R_{thjc} for D2-PAK: according to Mil standard 883-1012 test method.

R_{thja} for D2-PAK: according to JESD51-2, test method environmental condition and JESD51-3, low effective thermal conductivity test board for leaded surface mount package. thermal measurements. JESD51-2: Integrated Circuits Thermal Test Method Environmental Conditions - Natural Convection (Still Air).

Typical Performance Characteristics

Figure 1. Typical Output Characteristics

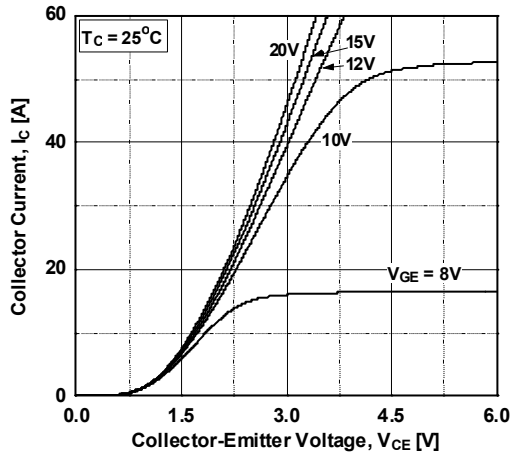

Figure 2. Typical Output Characteristics

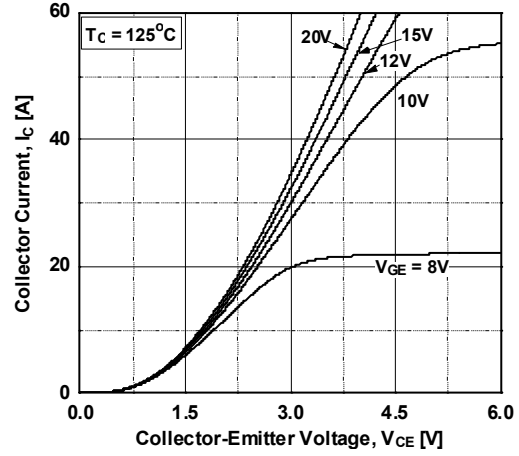

Figure 3. Typical Saturation Voltage Characteristics

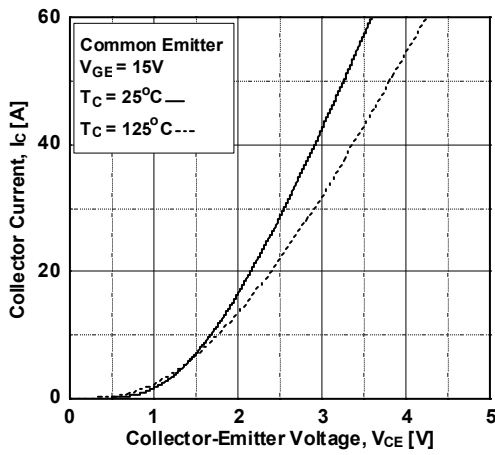

Figure 4. Transfer Characteristics

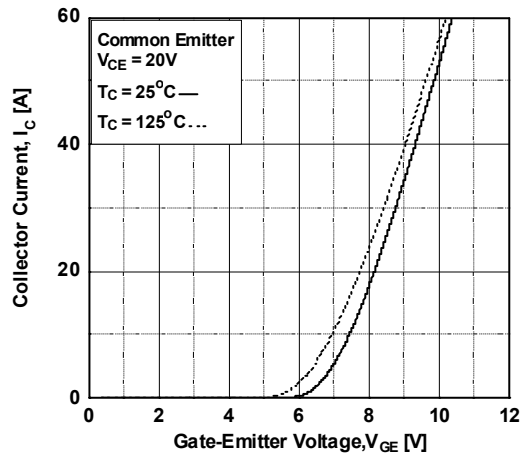

Figure 5. Saturation Voltage vs. Case Temperature at Variant Current Level

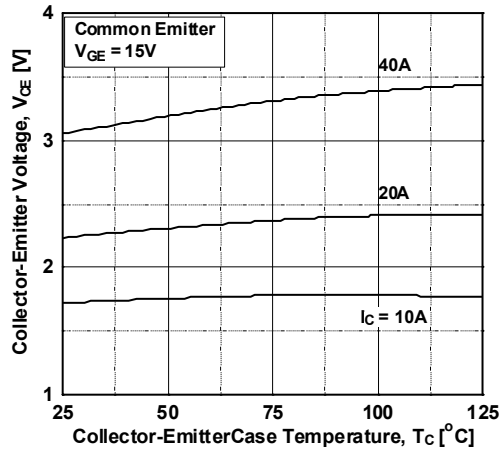
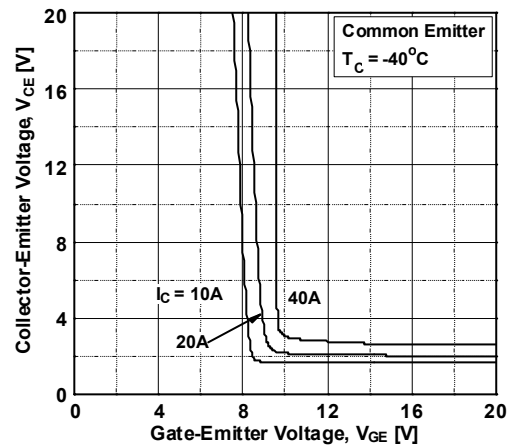

Figure 6. Saturation Voltage vs. Vge



Typical Performance Characteristics

Figure 7. Saturation Voltage vs. V_{GE}

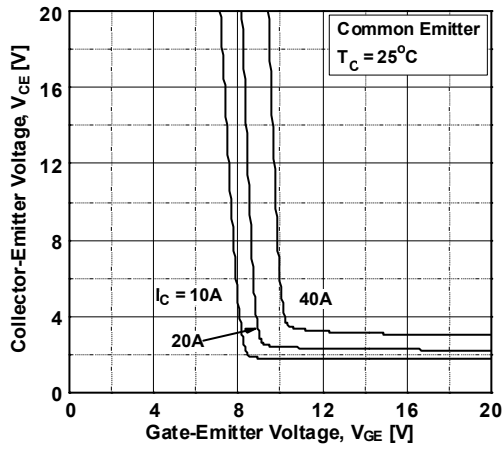

Figure 8. Saturation Voltage vs. V_{GE}

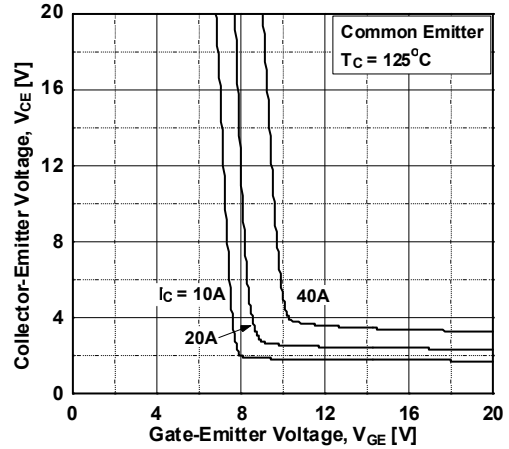

Figure 9. Capacitance Characteristics

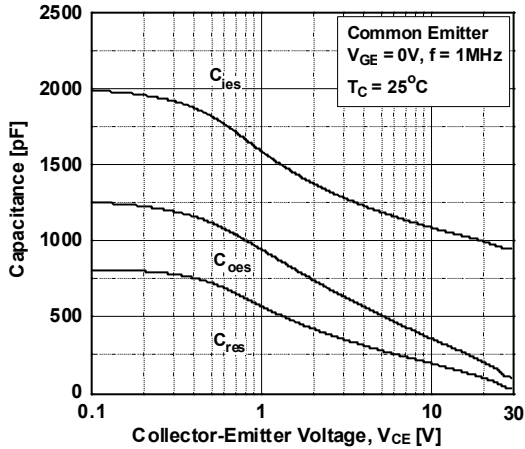

Figure 10. Gate charge Characteristics

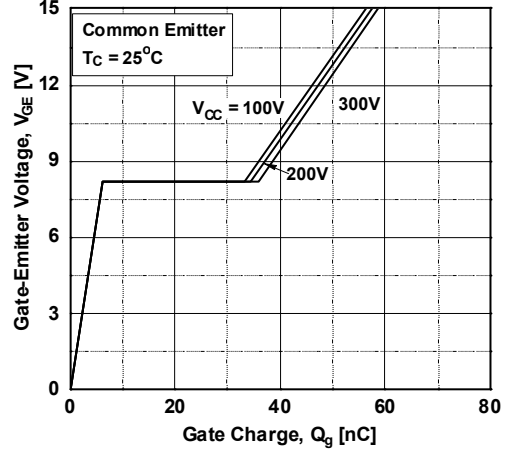

Figure 11. SOA Characteristics

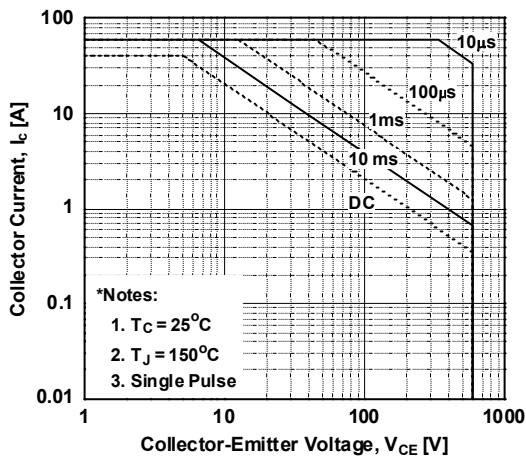
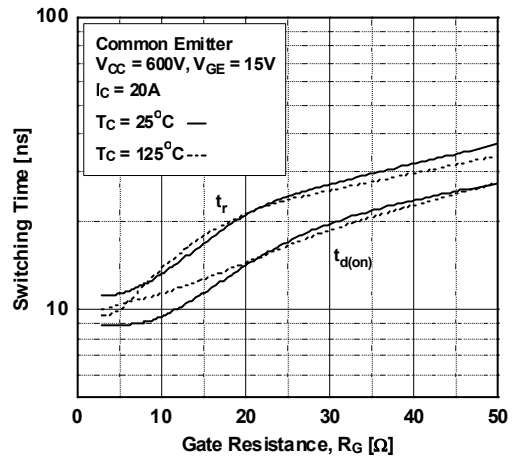

Figure 12. Turn-on Characteristics vs. Gate Resistance



Typical Performance Characteristics

Figure 13. Turn-off Characteristics vs. Gate Resistance

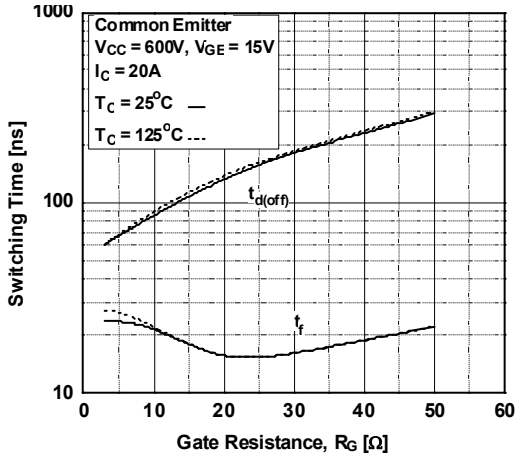

Figure 14. Turn-on Characteristics vs. Collector Current

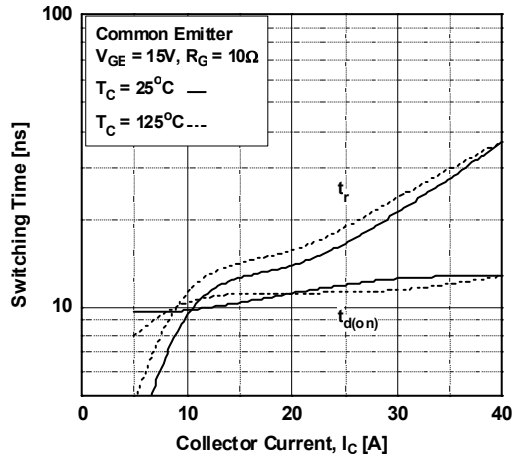

Figure 15. Turn-off Characteristics vs. Collector Current

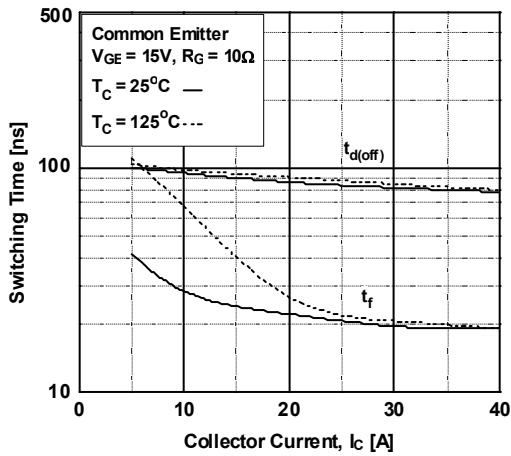

Figure 16. Switching Loss vs. Gate Resistance

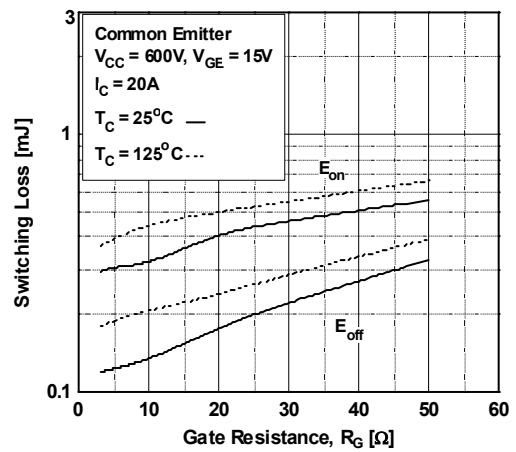

Figure 17. Switching Loss vs. Collector Current

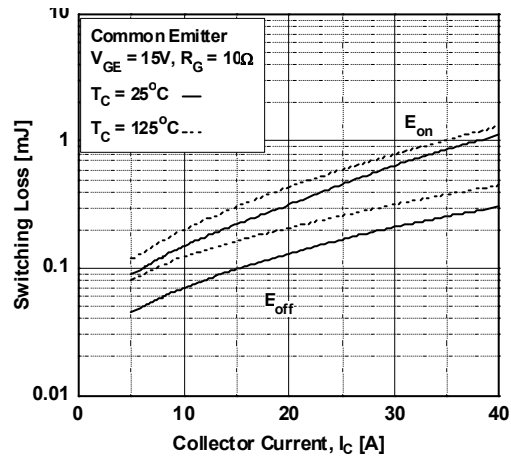
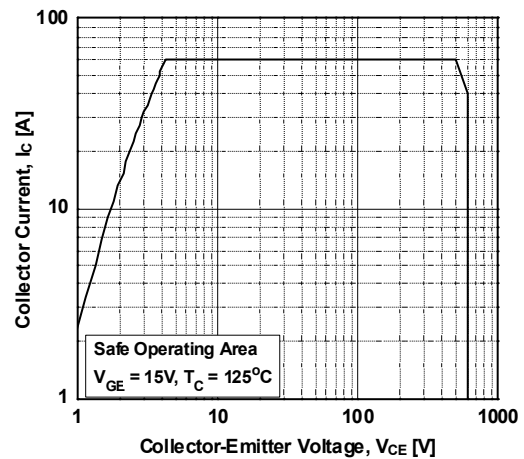

Figure 18. Turn off Switching SOA Characteristics



Typical Performance Characteristics

Figure 19. Forward Characteristics

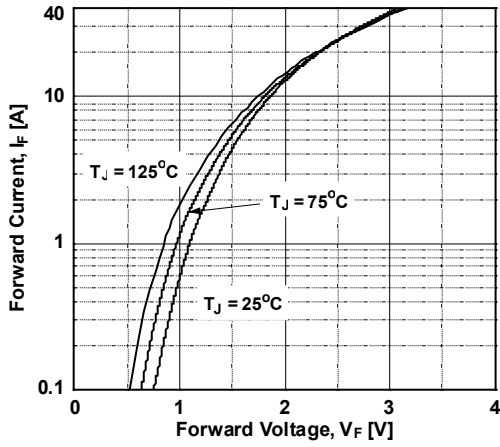

Figure 20. Typical Reverse Current vs. Reverse Voltage

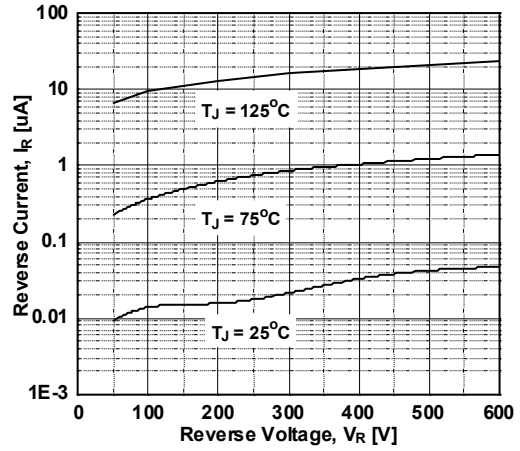

Figure 21. Stored Charge

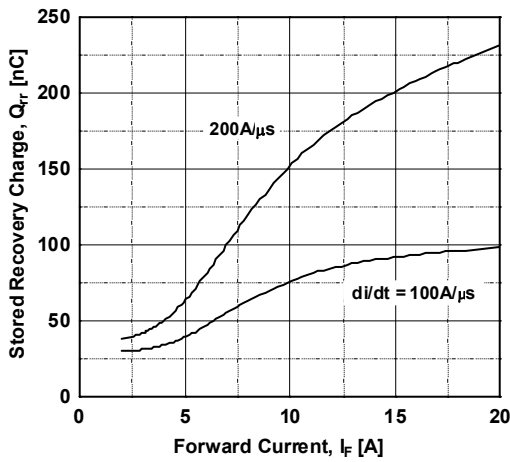

Figure 22. Reverse Recovery Time

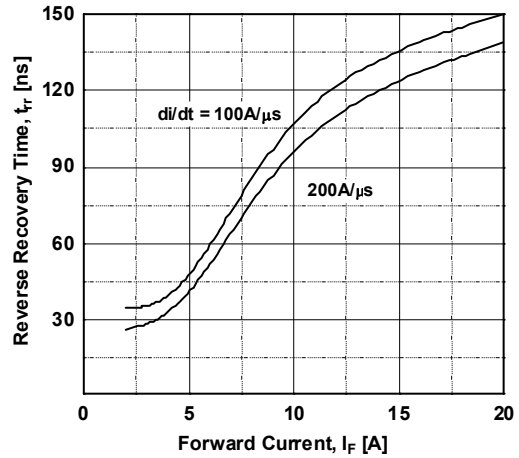
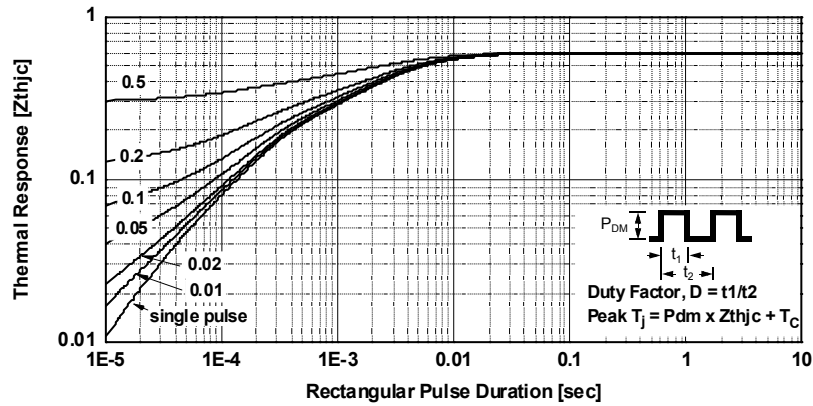
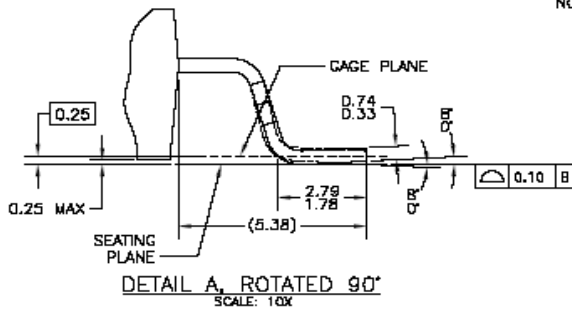
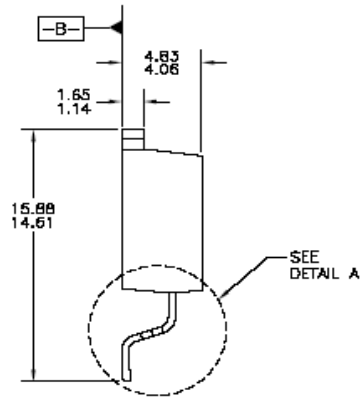
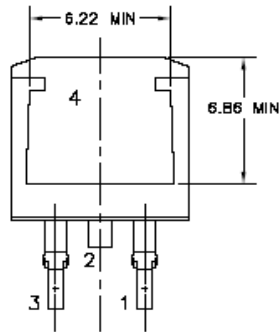
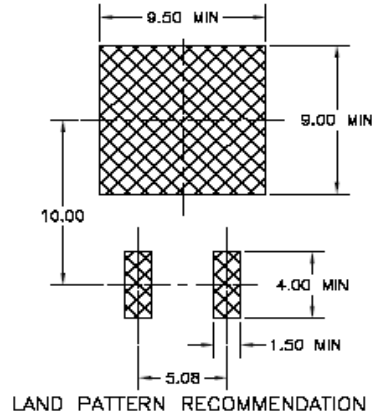
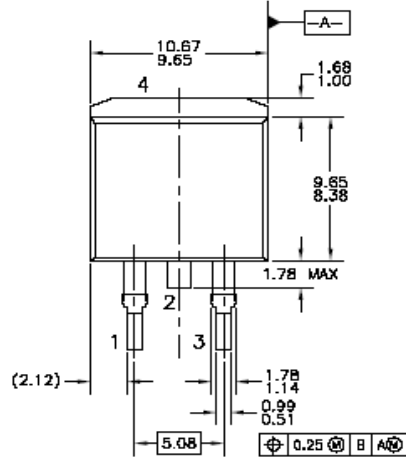

Figure 23. Transient Thermal Impedance of IGBT



Mechanical Dimensions

D²PAK



- NOTES: UNLESS OTHERWISE SPECIFIED
- A) ALL DIMENSIONS ARE IN MILLIMETERS.
 - B) REFERENCE JEDEC, TO-263, ISSUE D, VARIATION AB, DATED JULY 2003.
 - C) DIMENSIONING AND TOLERANCING PER ANSI Y14.5M - 1982.
 - D) LOCATION OF THE PIN HOLE MAY VARY (LOWER LEFT CORNER, LOWER CENTER AND CENTER OF THE PACKAGE).
 - E) PRESENCE OF TRIMMED CENTER LEAD IS OPTIONAL.

T02B3AD2REV D

Dimensions in Millimeters

ON Semiconductor and  are trademarks of Semiconductor Components Industries, LLC dba ON Semiconductor or its subsidiaries in the United States and/or other countries. ON Semiconductor owns the rights to a number of patents, trademarks, copyrights, trade secrets, and other intellectual property. A listing of ON Semiconductor's product/patent coverage may be accessed at www.onsemi.com/site/pdf/Patent-Marking.pdf. ON Semiconductor reserves the right to make changes without further notice to any products herein. ON Semiconductor makes no warranty, representation or guarantee regarding the suitability of its products for any particular purpose, nor does ON Semiconductor assume any liability arising out of the application or use of any product or circuit, and specifically disclaims any and all liability, including without limitation special, consequential or incidental damages. Buyer is responsible for its products and applications using ON Semiconductor products, including compliance with all laws, regulations and safety requirements or standards, regardless of any support or applications information provided by ON Semiconductor. "Typical" parameters which may be provided in ON Semiconductor data sheets and/or specifications can and do vary in different applications and actual performance may vary over time. All operating parameters, including "Typicals" must be validated for each customer application by customer's technical experts. ON Semiconductor does not convey any license under its patent rights nor the rights of others. ON Semiconductor products are not designed, intended, or authorized for use as a critical component in life support systems or any FDA Class 3 medical devices or medical devices with a same or similar classification in a foreign jurisdiction or any devices intended for implantation in the human body. Should Buyer purchase or use ON Semiconductor products for any such unintended or unauthorized application, Buyer shall indemnify and hold ON Semiconductor and its officers, employees, subsidiaries, affiliates, and distributors harmless against all claims, costs, damages, and expenses, and reasonable attorney fees arising out of, directly or indirectly, any claim of personal injury or death associated with such unintended or unauthorized use, even if such claim alleges that ON Semiconductor was negligent regarding the design or manufacture of the part. ON Semiconductor is an Equal Opportunity/Affirmative Action Employer. This literature is subject to all applicable copyright laws and is not for resale in any manner.

PUBLICATION ORDERING INFORMATION

LITERATURE FULFILLMENT:

Literature Distribution Center for ON Semiconductor
19521 E. 32nd Pkwy, Aurora, Colorado 80011 USA
Phone: 303-675-2175 or 800-344-3860 Toll Free USA/Canada
Fax: 303-675-2176 or 800-344-3867 Toll Free USA/Canada
Email: orderlit@onsemi.com

N. American Technical Support: 800-282-9855 Toll Free
USA/Canada
Europe, Middle East and Africa Technical Support:
Phone: 421 33 790 2910
Japan Customer Focus Center
Phone: 81-3-5817-1050

ON Semiconductor Website: www.onsemi.com
Order Literature: <http://www.onsemi.com/orderlit>
For additional information, please contact your local
Sales Representative