

Using the UCC28810EVM-001

User's Guide



Literature Number: SLUU344B
February 2009–Revised June 2009

UCC28810EVM-001 25-W PFC Flyback LED Converter

1 Introduction

The UCC28810EVM-001 evaluation module is a 25-W off-line power factor correction (PFC) flyback converter providing 36 V at 750-mA maximum load current to power a string of lighting class LEDs. This EVM allows the customer to evaluate the UCC28810 in an application where LEDs can be used for general illumination applications that require dimming.

2 Description

This evaluation module uses the UCC28810 LED Lighting Power Controller ([TI Literature Number SLUS865](#)) in a 25-W single stage triac dimmable PFC flyback converter that meets the harmonic current or power factor requirements set out by various standards. The input accepts a voltage range of 85 VAC to 305 VAC. The output provides a constant current of 750 mA, maximum, at up to 36 VDC to drive a string of LEDs such as the HPA475, provided with the EVM. The UCC28810EVM-001 is designed to be used with a triac dimmer switch, available at any hardware or lighting store, in series with the input voltage to control the lumen output of the LEDs. The converter operates in critical conduction mode.

This user's guide provides the schematic, component list, assembly drawing, and test set up necessary to evaluate the UCC28810 for an ac input LED lighting application.

To use an input voltage greater than 265 VAC, it is recommended the user change the fuse, F1, to one rated for at least 300 V at 1 A.

2.1 Typical Applications

The UCC28810 is suited for use in general lighting applications for low to medium power lumens applications requiring power factor correction:

- Industrial, Commercial, Residential Lighting Fixtures
- AC Input General Lighting Applications Using High Brightness (HB) LEDs
- Outdoor Lighting: Street, Roadway, Parking, Construction, and Ornamental LED Lighting Fixtures

2.2 Features

The UCC28810EVM-001 features include:

- 85 VAC to 305 VAC Input Voltage Range
- 25 W Output at 750 mA
- Single Stage PFC LED Driver
- Interfaces With Traditional Wall Dimmers
- Critical Conduction Mode
- Transformer Zero Energy Detection
- Peak Current Limit

3 Electrical Performance Specifications

Table 1. UCC28810EVM-001 Electrical Performance Specifications

SYMBOL	PARAMETER	TEST CONDITIONS	MIN	NOM	MAX	UNITS
Input Characteristics						
V_{IN}	Voltage range		85		265	VAC
f_{LINE}	Input frequency		47		63	kHz
$I_{IN(max)}$	Input current	$V_{IN} = 85 \text{ VAC}$, $f_{LINE} = 60 \text{ Hz}$, $I_{OUT} = \text{full load}^{(1)}$		0.4		A
$I_{IN(no_load)}$	No load input current	$V_{IN} = 85 \text{ VAC}$, $f_{LINE} = 60 \text{ Hz}$, $I_{OUT} = 0 \text{ A}$		12		mA
Output Characteristics						
V_{OUT}	Output voltage	$I_{OUT} = \text{full load}^{(1)}$	29	33	36	V
I_{OUT}	Output load current			0.7		A
	Output current regulation	$V_{IN} = 85 \text{ VAC to } 265 \text{ VAC}$, $I_{OUT} = \text{full load}^{(1)}$		10	15	%
	Output voltage ripple	$I_{OUT} = \text{full load}^{(1)}$		2		V _{pp}
$V_{OUT(OVP)}$	Output over voltage protection			45		V
System Characteristics						
PF	Power factor	$I_{OUT} = \text{full load}^{(1)}$	0.9			
η	Full load efficiency	$V_{IN} = 115 \text{ VAC}$		89.5		%
THD	Total harmonic distortion	$V_{IN} = 115 \text{ VAC}$, $I_{OUT} = \text{full load}^{(1)}$		24		
	Operating temperature				50	°C

⁽¹⁾ Full load is ten Cree XLamp® 7090 XR-E, white, 700-mA LEDs in series, as provided with the HPA475 LED load board.

4 Schematic

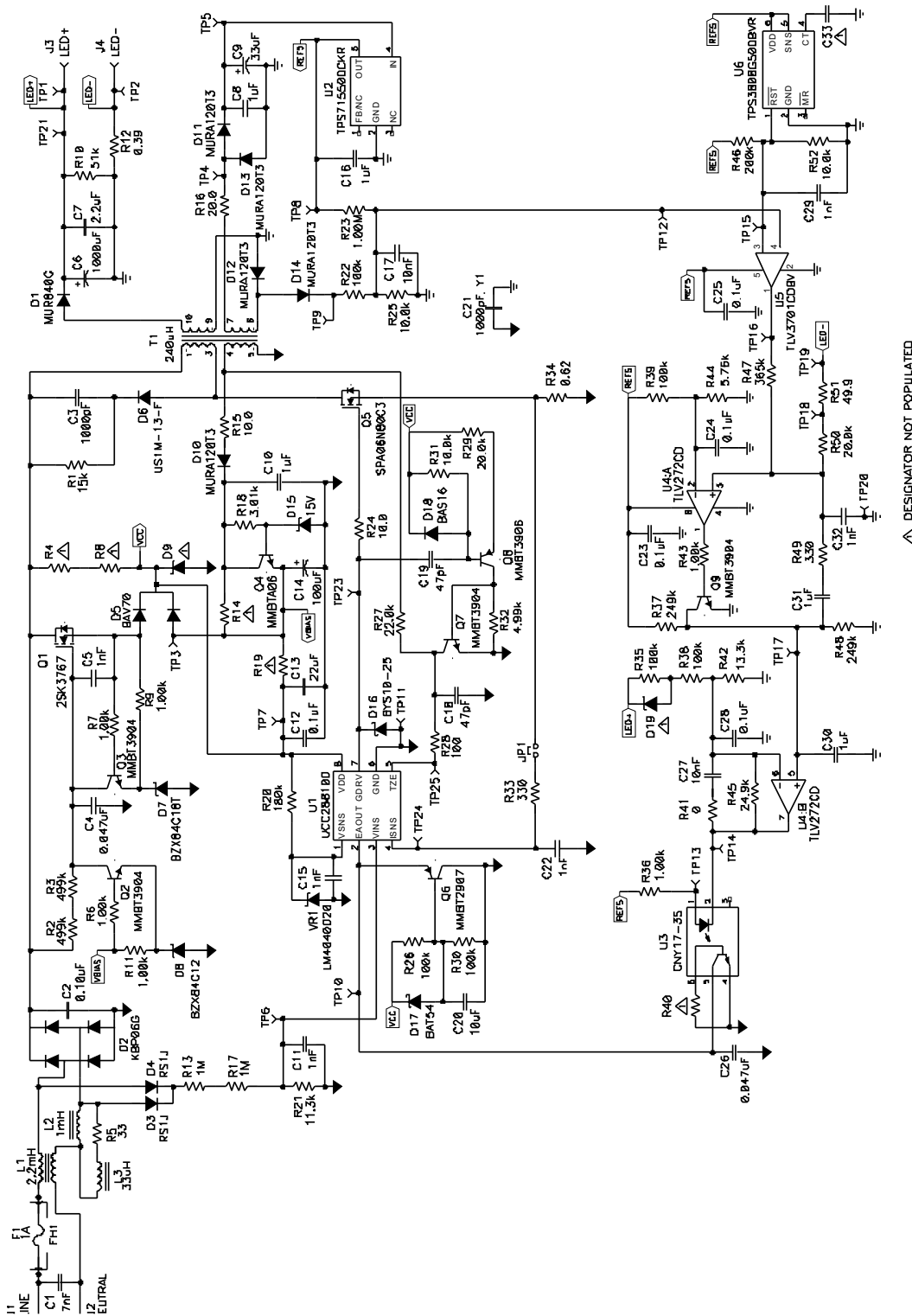

△ DESIGNATOR NOT POPULATED

Figure 1. UCC28810EVM-001 Schematic

5 Test Setup

CAUTION

High voltage levels are present on the evaluation module whenever it is energized. Proper precautions must be taken when working with the EVM. The large bulk capacitor across the output terminals must be completely discharged before the EVM can be handled. Serious injury can occur if proper safety precautions are not followed.

5.1 Test Equipment

Refer to [Figure 2](#) for recommended test set up.

5.1.1 AC Voltage Source

The input voltage shall be a transformer isolated variable ac source capable of supplying between 85 VAC and 265 VAC, at 60 Hz, at no less than 5 A peak (i.e. Hewlett Packard 6813B 300 VRMS, 1750 VA AC Power Source/Analyzer or VARIAC).

5.1.2 Multimeters

For highest accuracy, the output voltage of the UCC28810EVM-001 shall be monitored by connecting a digital voltmeter, V2, directly across TP21 and TP2 with the positive terminal at TP21 and the negative terminal at TP2, as shown in [Figure 2](#). A dc current meter, A2, should be placed in series with the load for accurate current measurements. If using an ac source that does not have an analyzer function, connect a voltmeter, V1, across the input terminals, J1 (Line) and J2 (Neutral) and a current meter, A1, in series with the line input.

5.1.3 Output Load

It is recommended that the HPA475 LED board be used for the load. The HB LEDs are specified for a total forward voltage of 35 V, typical, at 700 mA of current. The HPA475 consists of Ten Cree XLamp® 7090 XR-E, white, 700-mA LEDs connected in series was used for the data documented in this user's guide. Alternatively, a 50-Ω, 50-W resistor can be used.

5.1.4 Oscilloscope

A digital or analog oscilloscope with 500-MHz scope probes and a current probe is recommended.

5.1.5 Dimmer

A triac dimmer switch, available at hardware or lighting stores, can be inserted in series with the input line. If a dimmer switch is not available, with minor circuit changes, a function generator can be used to generate a PWM dimming control signal to replicate the triac dimmer.

5.1.6 Fan

Forced air cooling is not required.

5.1.7 Recommended Wire Gauge

A minimum of 14 AWG, not longer than two feet total for Line (J1), and Neutral (J2), is recommended. A minimum of 18 AWG, not longer than one foot total, for the load connection to LED+ (J3) and LED- (J4) is recommended. Both input and output terminals are designed to accept banana jack connectors.

5.2 Recommended Test Setup

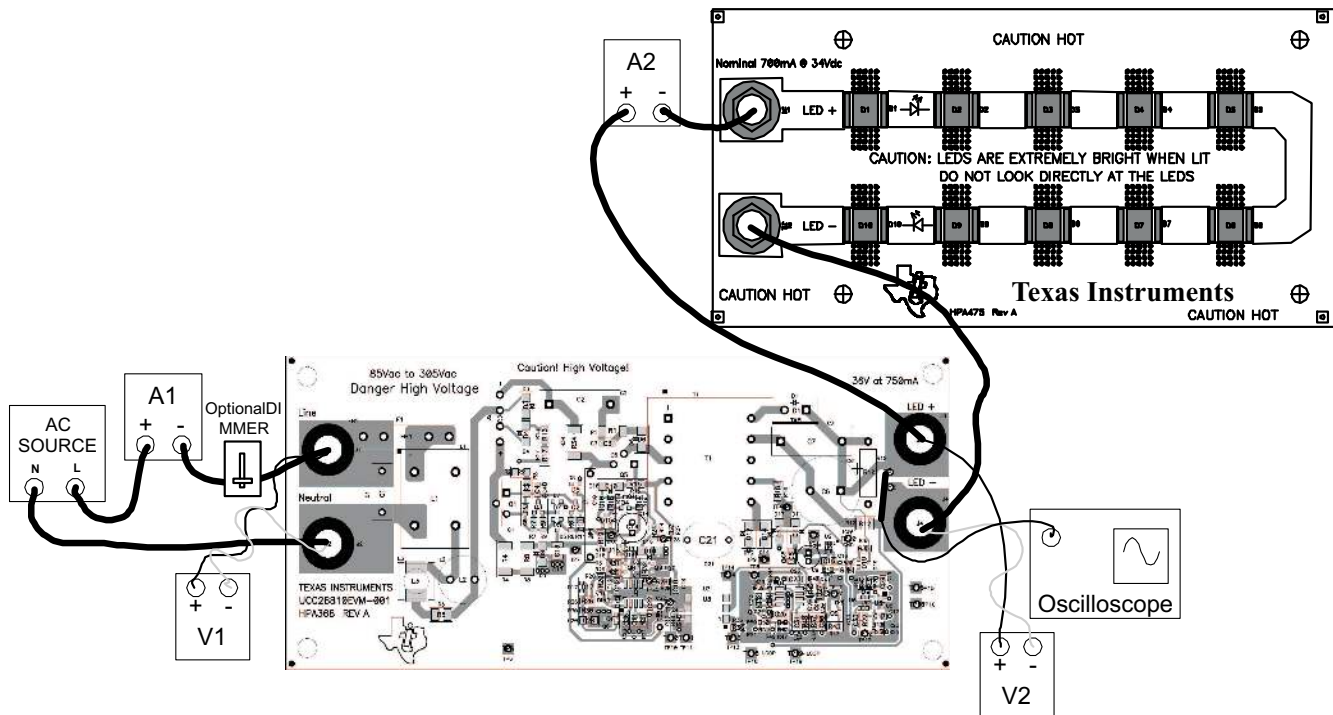

Figure 2. UCC28810EVM-001/HPA475 Recommended Test Set Up

5.3 List of Test Points

Table 2. The Functions of Each Test Points

TEST POINTS	NAME	DESCRIPTION
TP1	LED+	Via in converter output voltage pad, used for tip and barrel measurement of output voltage ripple
TP2	LED-	Return of LED string, used for tip and barrel measurement of output ripple
TP3	VBIAS	Primary side bias to UCC28810 (U1), reference to TP11
TP4		Secondary side bias windings, reference to TP20
TP5	U2_IN	Pin 4 (IN) of TPS71550 (U2), reference to TP20
TP6	U1_VINS	Pin 3 (VINS) of U1, reference to TP11
TP7	U1_VDD	Pin 8 (VDD) of U1, reference to TP11
TP8	REF5	Pin 5 (OUT) of U2, reference to TP20
TP9		Rectified Secondary side bias windings, reference to TP20
TP10	EAOUT	Pin 2 (EAOUT) of U1, reference to TP11
TP11	P_GND	Primary side ground
TP12	U5_IN-	Pin 4 (IN-) of TLV3701 (U5), scaled copy of input voltage waveform, reference to TP20
TP13		Pin 1 (Anode) of CNY17-3S (U3), reference to TP20
TP14	U4_2OUT	Pin 2 (Cathode) of U3, also pin 7 (2OUT) of TLV272 (U4), reference to TP20
TP15	U5_IN+	Pin 3 (IN+) of U5, reference to TP20
TP16	U5_OUT	Pin 1 (OUT) of U5, reference to TP20
TP17	U4_2IN+	Pin 5 (2IN+) of U4, reference to TP20
TP18		Loop injection point
TP19		Loop injection point, LED-
TP20	S_GND	Secondary side ground
TP21	LED+	Input to LED string
TP23	U1_GDRV	Pin 7 (GDRV) of U1, reference to TP11
TP24	U1_ISNS	Pin 4 (ISNS) of U1, reference to TP11
TP25	U1_TZE	Pin 5 (TZE) of U1, reference to TP11
J1	LINE	Line input from AC source, standard banana jack
J2	NEUTRAL	Neutral input from AC source, standard banana jack
J3	LED+	Output terminal to the LED load string, standard banana jack
J4	LED-	Return connection for the LED string, standard banana jack

6 Test Procedure

All tests should use the set up as described in Section 5 of this user's guide.

WARNING

WARNING HIGH VOLTAGES are present on this evaluation module whenever it is energized. Proper precautions must be observed whenever working with this module. There is an energy storage capacitor (C6) on this module which must be discharged before the board can be handled. Serious injury can occur if proper safety procedures are not followed.

6.1 Applying Power to the EVM

The following test procedure is recommended primarily for power up and shutting down the EVM. Never leave a powered EVM unattended for any length of time. The unit should never be handled while power is applied to it. Always make sure the bulk capacitor has been completely discharged prior to handling the EVM.

- Working at an ESD workstation, turn on the ionizer before the EVM is removed from the protective packaging and power is applied. Electrostatic smock and safety glasses should also be worn. Because voltages in excess of 400V may be present on the EVM, do not connect the ground strap from the smock to the bench.
- Set up the EVM as described in Section 5 of this user's guide.
- Connect the LED load board HPA475 across the output terminals.
- Prior to turning on the ac source, set the voltage to 115 VAC. For operation with an input voltage greater than 265 VAC, but not greater than 305 VAC, change the fuse, F1, to one rated for at least 300 V at 1 A
- Monitor the output voltage, V2.
- Monitor the output current, A2.

6.2 Line Regulation

- Apply power to the EVM per Section 6.1
- Vary the input voltage from 85 VAC to 265 VAC.
- Observe the output current on A2 stays within approximately 10% of the output current measured at 115 VAC.

6.3 Output Voltage Ripple

- Expose the ground barrel of the scope probe. Insert the tip of the probe into the plated via located on the LED+ pad of the UCC28810EVM (TP1) and lean the probe so that the exposed ground barrel is resting on the test point pin on the LED- pad of the UCC28810EVM (TP2) for a tip and barrel measurement as shown in [Figure 3](#).
- Apply power to the UCC28810EVM per Section 6.1.
- Monitor the output voltage ripple on the oscilloscope.

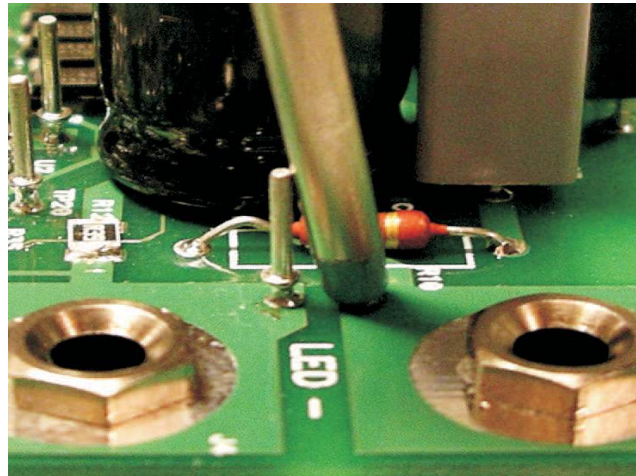

Figure 3. Tip and Barrel Technique for Output Voltage Ripple Measurement

6.4 Dimming

- Ensure the ac source is off.
- Connect the external dimmer in series with the ac LINE.
- Apply power to the EVM per Section 6.1. Do not apply an input voltage greater than the rating of the dimmer switch.
- Observe the output current, measured by A2, vary as the dimmer switch is adjusted. Also observe the dimming of the LEDs. The existing dimming detection circuit functions by detecting the secondary side switching voltage of the flyback, present on TP9. The switching frequency is filtered out, as shown on TP12, and summed with an inverted replica of the blocked input phase into the feedback loop.
- If a dimmer switch is not available, dimming can be accomplished by directly modifying the current regulation point by inserting an externally generated signal into the phase detect circuit. The existing UCC28810EVM-001 must be modified by removing D14, R23, and C17 (shown in [Figure 1](#)). Using TP9 as an input terminal, connect a PWM dimming control signal.

6.5 Equipment Shutdown

- Ensure the ac source is off.
- Make sure the output capacitor, C6, is completely discharged before disconnecting the EVM.

7 Performance Data and Typical Characteristic Curves

Figure 4 through Figure 28 present typical performance curves for the UCC28810EVM-001. HPA475 (10 Cree XLamp® 7090 XR-E, white, 700mA LEDs connected in series) was used for the load, unless noted otherwise.

7.1 Efficiency

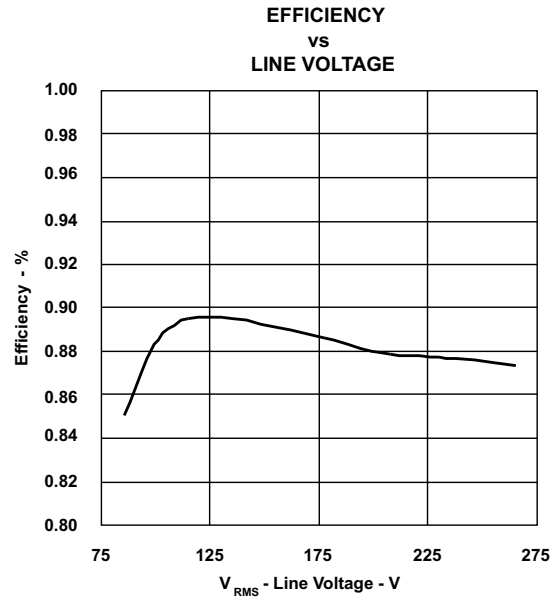

Figure 4.

7.2 Power Factor

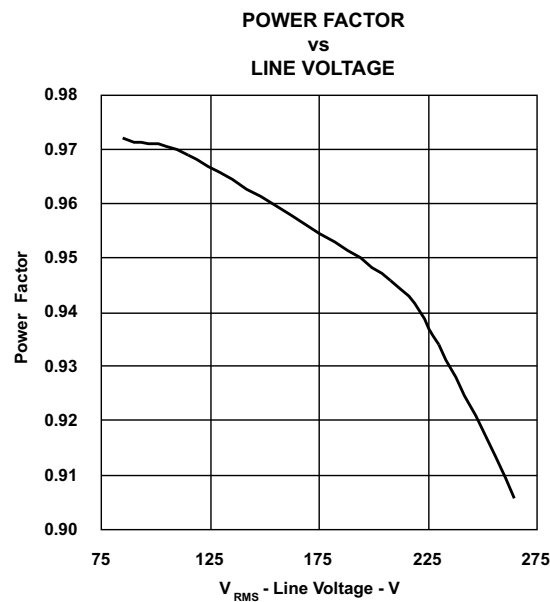

Figure 5.

7.3 Total Harmonic Distortion

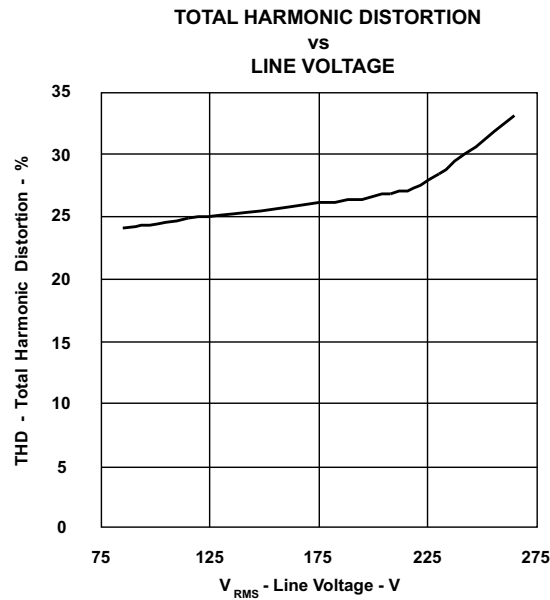

Figure 6.

7.4 Load Regulation

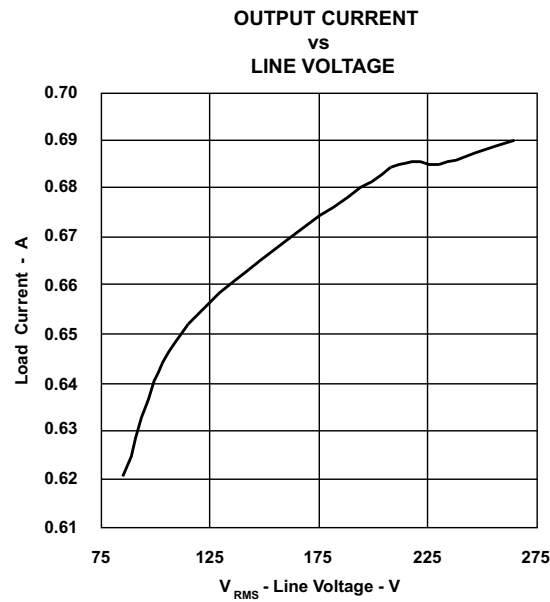

Figure 7.

7.5 Current Harmonics

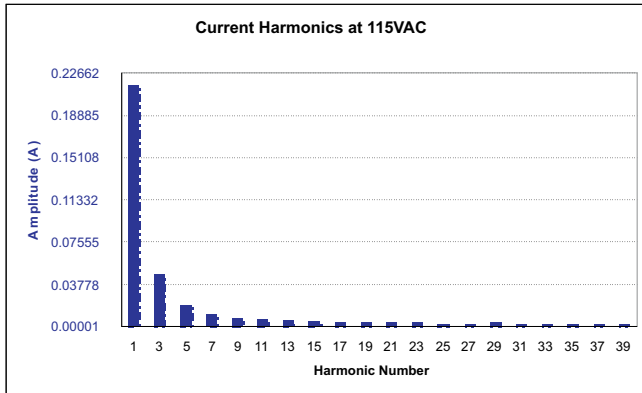

Figure 8. $V_{IN} = 115 \text{ VAC}$, $f_{LINE} = 60 \text{ Hz}$,

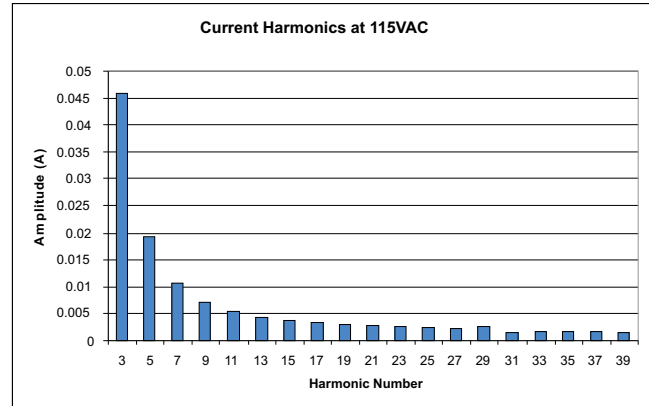

Figure 9. $V_{IN} = 115 \text{ VAC}$, $f_{LINE} = 60 \text{ Hz}$,
Re-Scaled Without the Fundamental

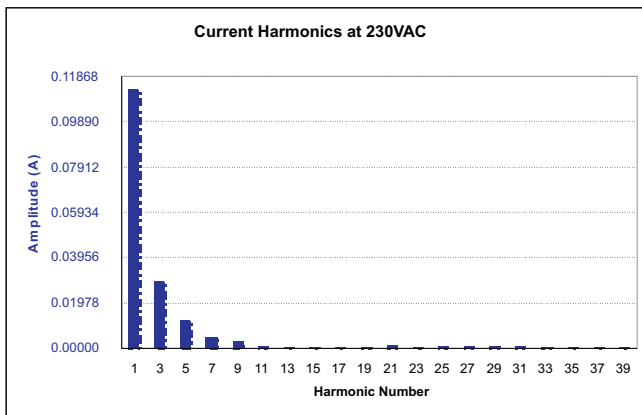

Figure 10. $V_{IN} = 230 \text{ VAC}$, $f_{LINE} = 60 \text{ Hz}$

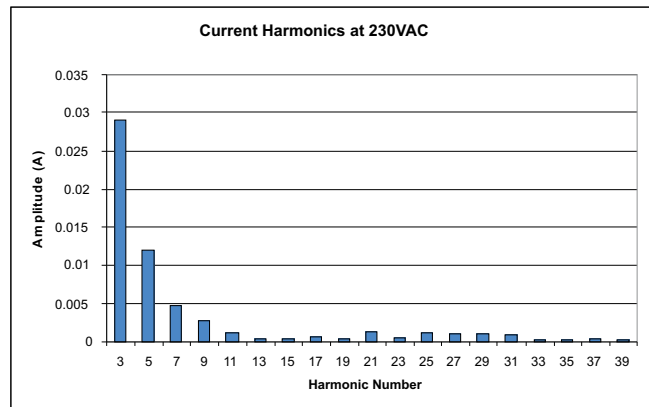

Figure 11. $V_{IN} = 230 \text{ VAC}$, $f_{LINE} = 60 \text{ Hz}$,
Re-Scaled Without the Fundamental

7.6 Input Voltage and Current

HPA475 (10 Cree XLamp® 7090 XR-E, white, 700-mA LEDs connected in series) was used for the load unless otherwise noted.

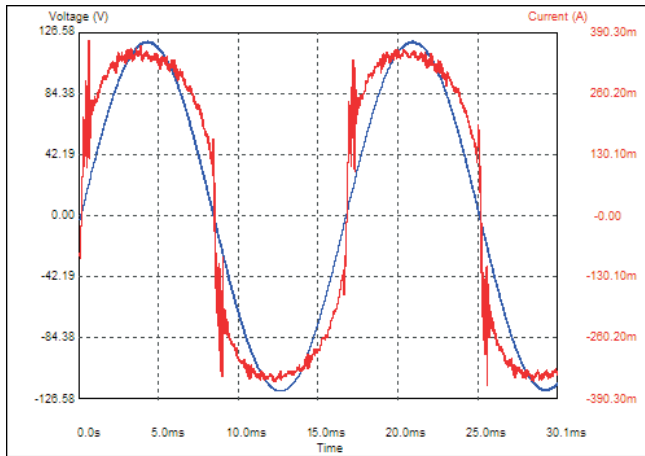

Figure 12. $V_{IN} = 85 \text{ VAC}$, $f_{LINE} = 60 \text{ Hz}$

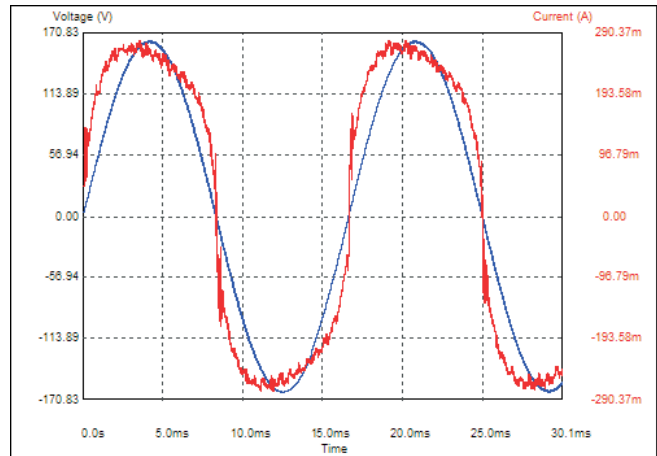

Figure 13. $V_{IN} = 115 \text{ VAC}$, $f_{LINE} = 60 \text{ Hz}$

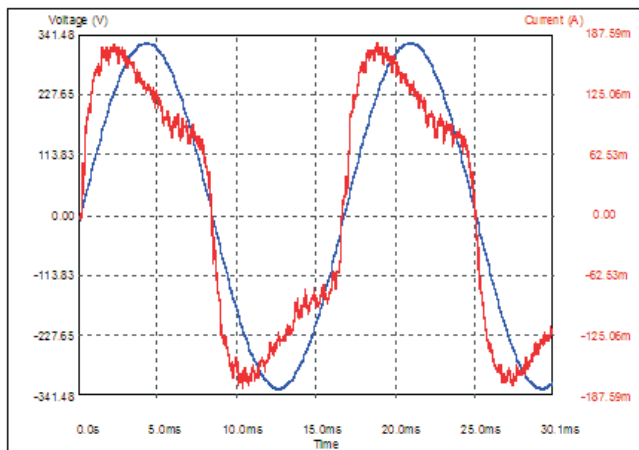

Figure 14. $V_{IN} = 230 \text{ VAC}$, $f_{LINE} = 60 \text{ Hz}$

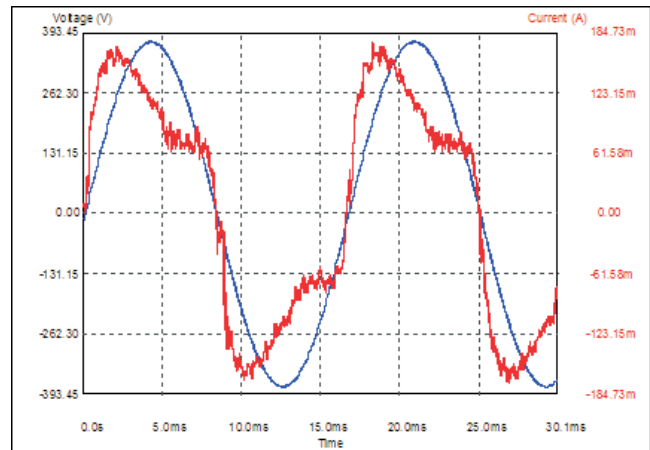

Figure 15. $V_{IN} = 265 \text{ VAC}$, $f_{LINE} = 60 \text{ Hz}$

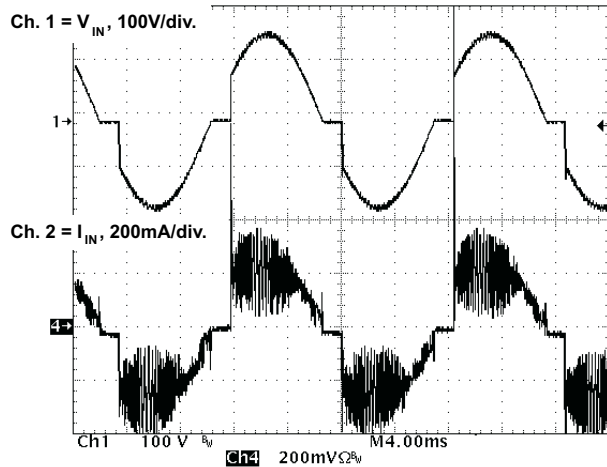

Figure 16. Dimmer Set at Full on Position, V_{IN} = 115 VAC from Source, f_{LINE} = 60 Hz, Output Current to LEDs (I_{OUT}) is 552 mA, V_{OUT} = 31.36 V

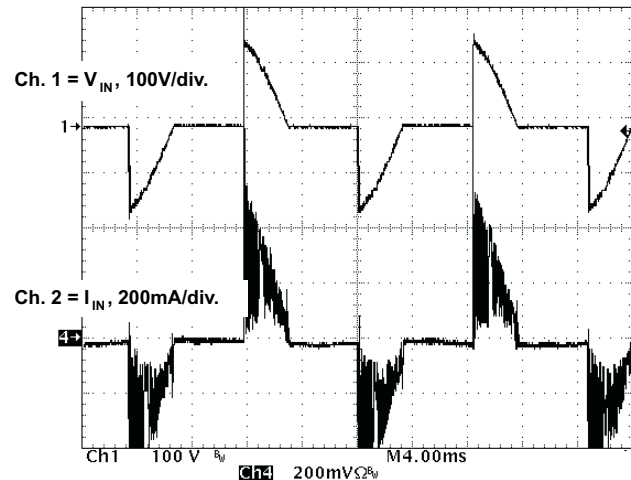

Figure 17. Dimmer Set at Mid-Range Dimming Position, V_{IN} = 115 VAC from Source, f_{LINE} = 60 Hz, Output Current to LEDs (I_{OUT}) is 255 mA, V_{OUT} = 29.57 V

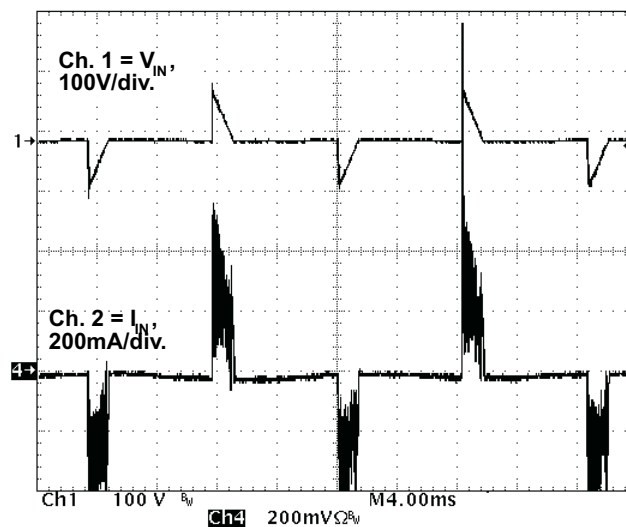

Figure 18. Maximum Dimming Position, V_{IN} = 115 VAC from Source, f_{LINE} = 60 Hz, Output Current to LEDs (I_{OUT}) is 52 mA, V_{OUT} = 27.42 V

7.7 Output Ripple

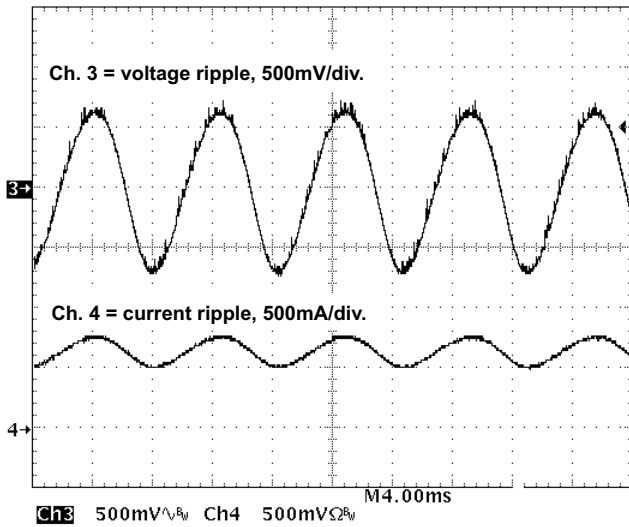

Figure 19. Output Voltage and Current Ripple, $V_{IN} = 115 \text{ VAC}$, $f_{LINE} = 60 \text{ Hz}$, No Dimmer, $V_{OUT} = 31.68 \text{ V}$, $I_{OUT} = 0.655 \text{ A}$

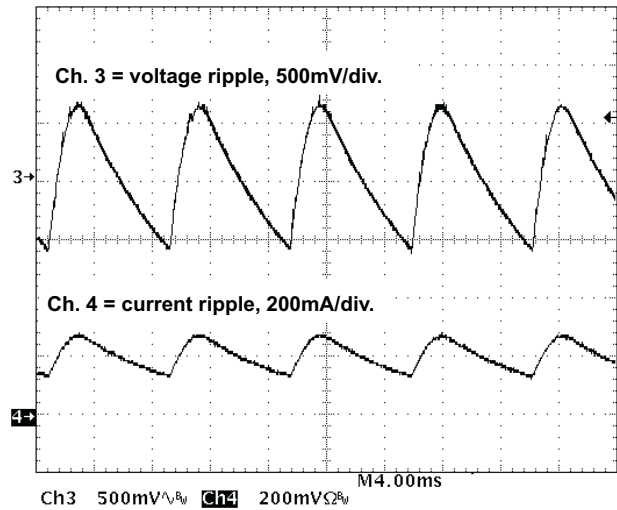

Figure 20. Output Voltage and Current Ripple, $V_{IN} = 115 \text{ VAC}$, $f_{LINE} = 60 \text{ Hz}$, Dimmer Set at Mid-Range Dimming Position, $V_{OUT} = 29.41 \text{ V}$, $I_{OUT} = 0.228 \text{ A}$

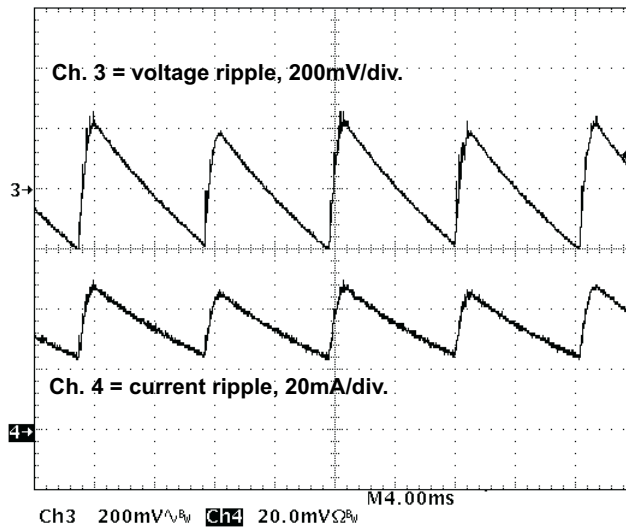

Figure 21. Output Voltage and Current Ripple, $V_{IN} = 115 \text{ VAC}$, $f_{LINE} = 60 \text{ Hz}$, Dimmer Set at Maximum Dimming Position, $V_{OUT} = 27.55 \text{ V}$, $I_{OUT} = 0.058 \text{ A}$

7.8 Turn-On Waveform

Output voltage turn-on waveform. Unless otherwise noted, HPA475 (10 Cree XLamp® 7090 XR-E, white, 700mA LEDs connected in series) was used for the load.

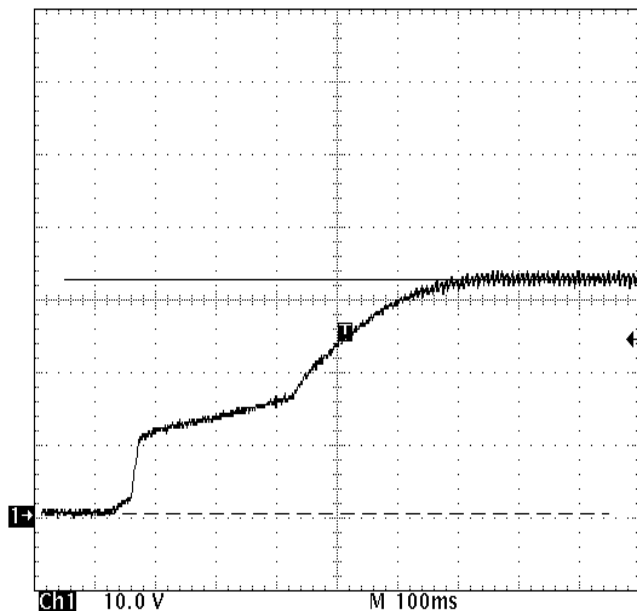

Figure 22. $V_{IN} = 115 \text{ VAC}$, $f_{LINE} = 60 \text{ Hz}$, No Dimmer, Ch. 1 = V_{OUT} , 10V/div. $V_{OUT} = 32.2 \text{ V}$

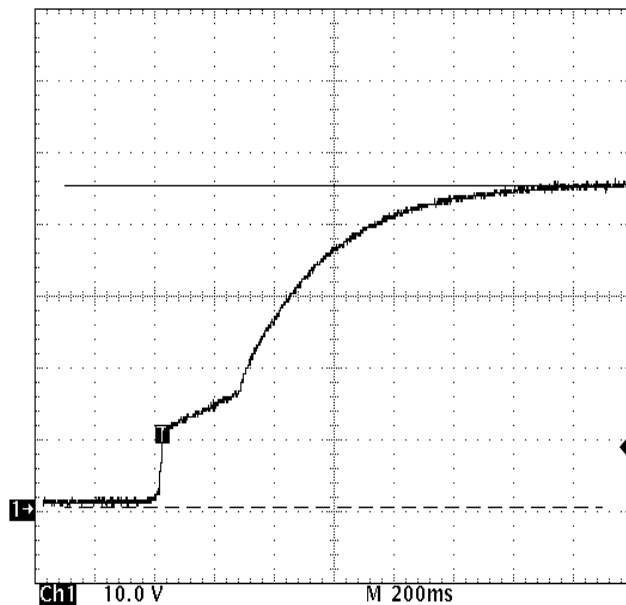

Figure 23. $V_{IN} = 115 \text{ VAC}$, $f_{LINE} = 60 \text{ Hz}$, No Dimmer, No Load. Ch. 1 = V_{OUT} , 10V/div. $V_{OUT} = 44.8 \text{ V}$

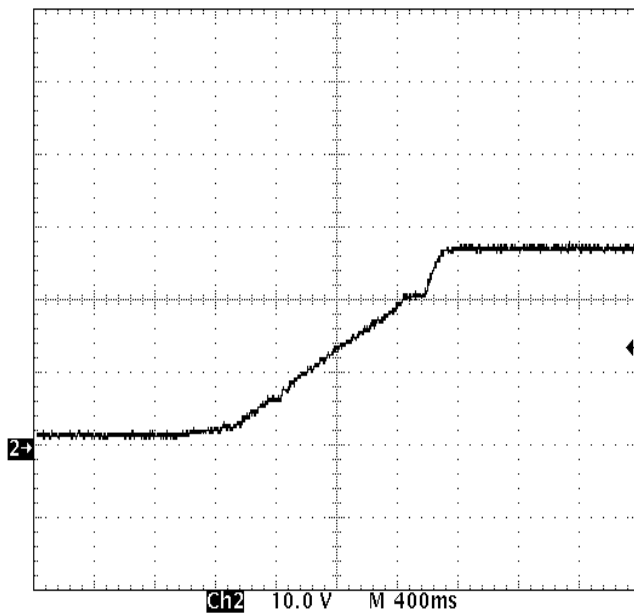

Figure 24. $V_{IN} = 115 \text{ VAC}$, $f_{LINE} = 60 \text{ Hz}$, Dimmer Set at Maximum Dimming Position, Ch. 1 = V_{OUT} , 10V/div. $V_{OUT} = 27.42 \text{ V}$

7.9 Dimming Detection:

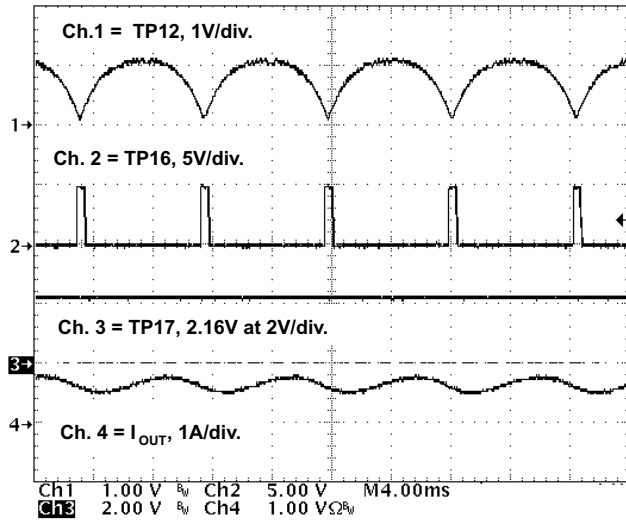

Figure 25. Triac Dimming Detection Signals, $V_{IN} = 115 \text{ VAC}$, $f_{LINE} = 60 \text{ Hz}$, $V_{OUT} = 31.66 \text{ V}$, $I_{OUT} = 0.653 \text{ A}$, (no dimmer on the input)

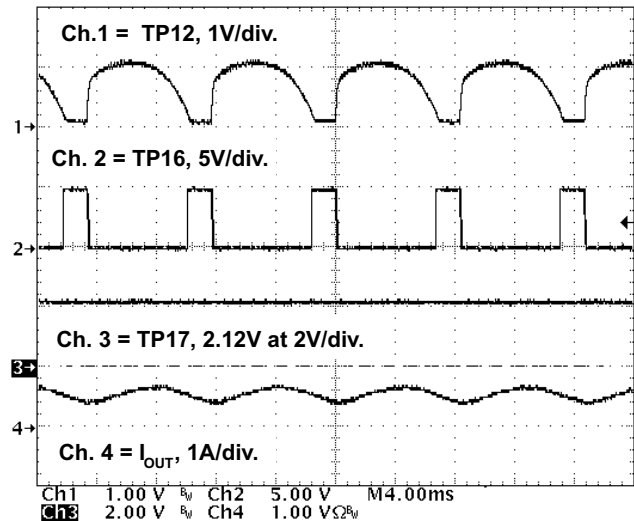

Figure 26. Triac Dimming Detection Signals, $V_{IN} = 115 \text{ VAC}$, $f_{LINE} = 60 \text{ Hz}$, $V_{OUT} = 31.19 \text{ V}$, $I_{OUT} = 0.552 \text{ A}$, (dimmer set at full on position)

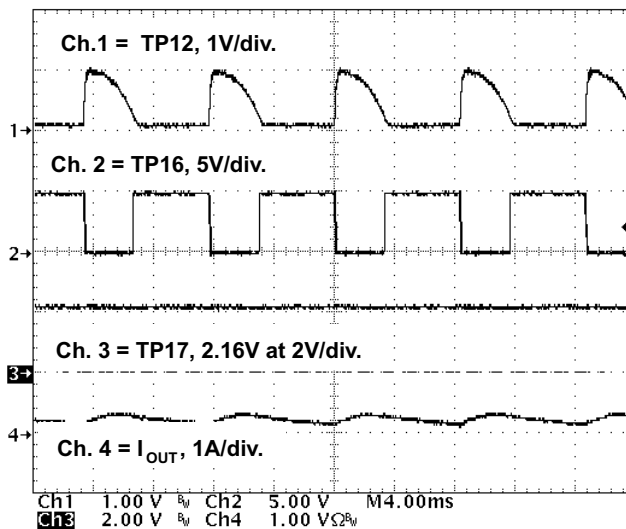

Figure 27. Triac Dimming Detection Signals, $V_{IN} = 115 \text{ VAC}$, $f_{LINE} = 60 \text{ Hz}$, $V_{OUT} = 29.54 \text{ V}$, $I_{OUT} = 0.266 \text{ A}$, (dimmer set at mid-range dimming position)

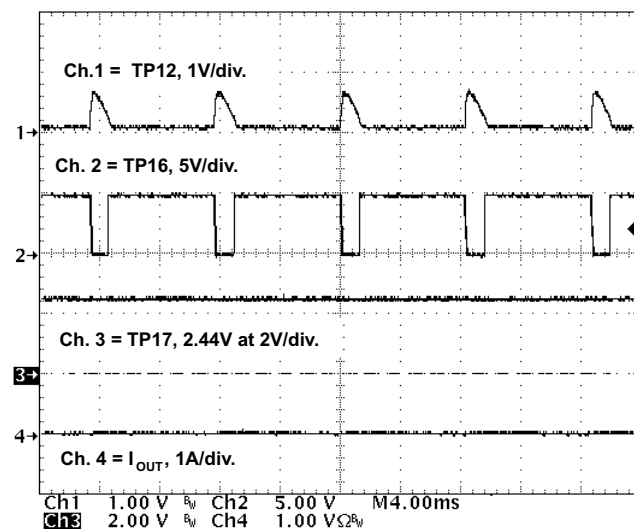

Figure 28. Triac Dimming Detection Signals, $V_{IN} = 115 \text{ VAC}$, $f_{LINE} = 60 \text{ Hz}$, $V_{OUT} = 27.44 \text{ V}$, $I_{OUT} = 0.058 \text{ A}$, (dimmer set at maximum dimming position)

8 EVM Assembly Drawing and PCB layout

The following (Figure 29 through Figure 30) show the design of the UCC28810EVM-001 printed circuit board.

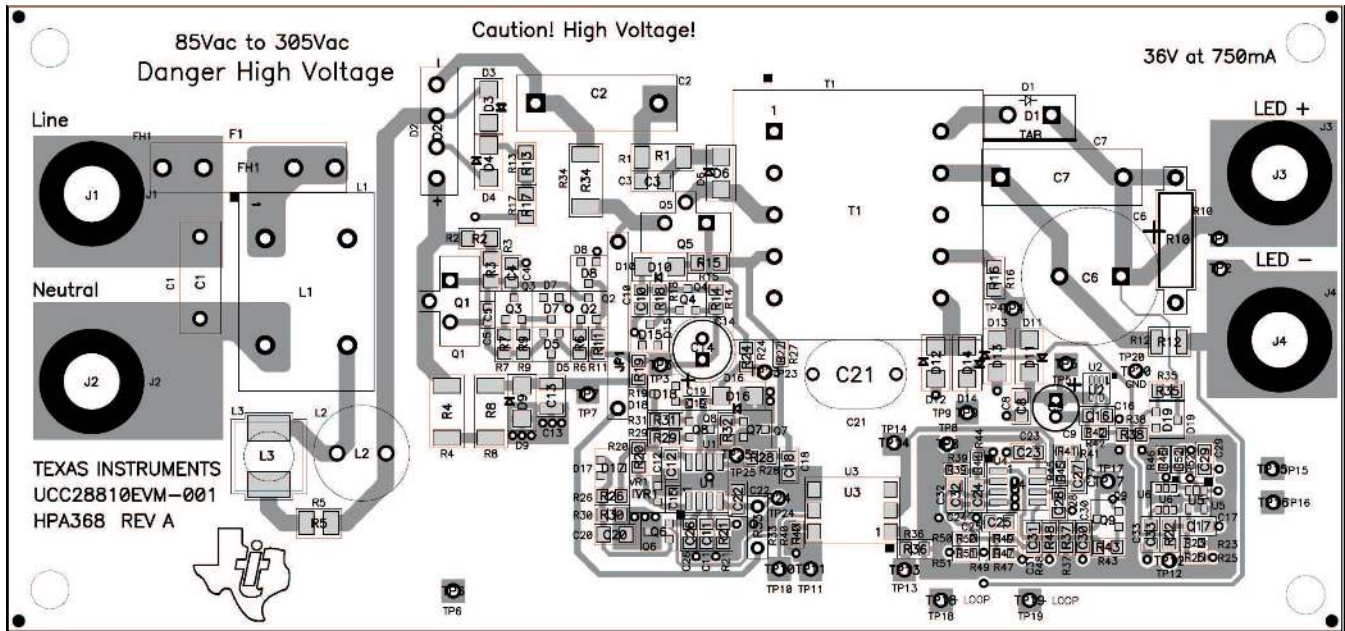

Figure 29. UCC28810EVM-001 Top Layer Assembly Drawing (top view)

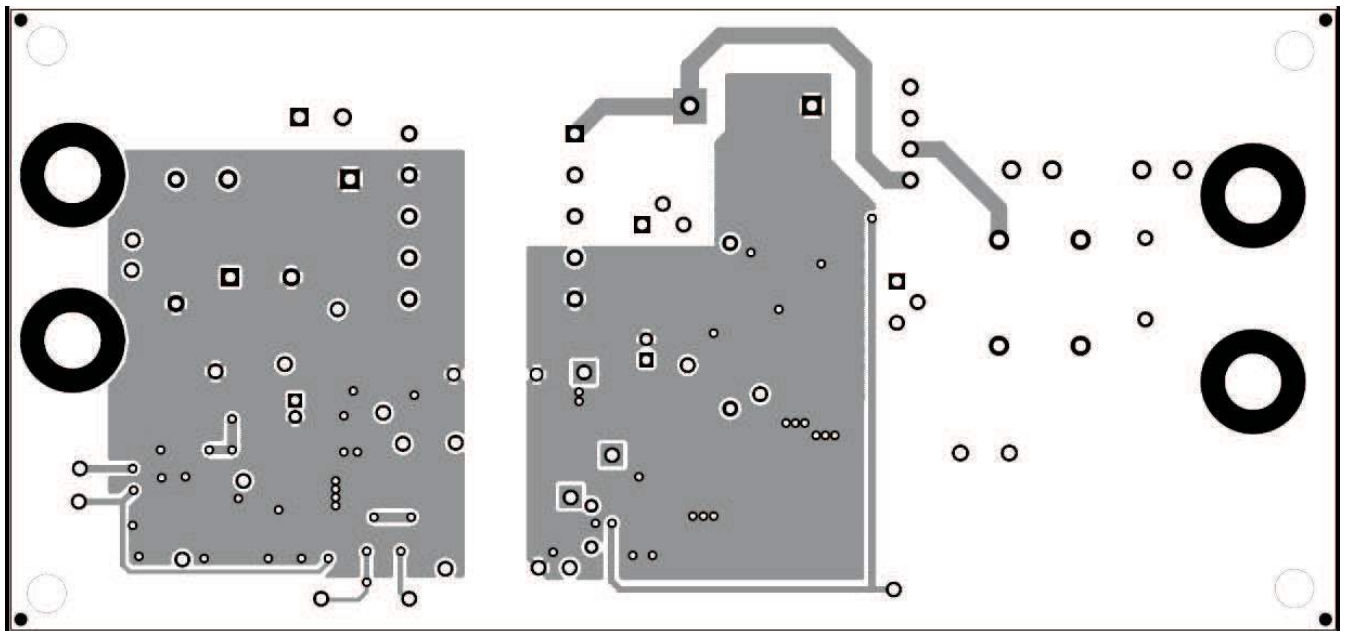

Figure 30. UCC28810EVM-001 Bottom Assembly Drawing (bottom view)

9 List of Materials

Table 3. The EVM Components List According to the Schematic Shown in Figure 1

REF DES	COUNT	DESCRIPTION	MFR	PART NUMBER
C1	1	Capacitor, polypropylene, 47 nF, X2, 305 VAC, ±20%, 0.236 x 0.512 inch	Epcos	B32921A2473M or B32921C3473M
C2	1	Capacitor, polypropylene, 0.10 µF, X2, 305 VAC, ±20%, 0.200 x 0.709 inch	Epcos	B32922C3104M
C3	1	Capacitor, ceramic, 1000 pF, 200 V, X7R, ±10%, 1206	Std	Std
C4, C26	2	Capacitor, ceramic, 0.047 µF, 50 V, X7R, ±10%, 0805	Std	Std
C5, C11, C15, C22, C29, C32	6	Capacitor, ceramic, 1 nF, 50 V, X7R, ±10%, 0805	Std	Std
C6	1	Capacitor, alum.electrolytic, 1000 µF, 50 V, ±20%, 16 x 25 mm	Panasonic	EEU-FM1H102
C7	1	Capacitor, metal Poly, 2.2 µF, 100 VDC, ±10%, 0.709 x 0.236 inch	Vishay	2222 373 21225
C8, C10, C16, C30, C31	5	Capacitor, ceramic, 1 µF, 50 V, X7R, ±10%, 0805	Std	Std
C9	1	Capacitor, aluminum, 33 µF, 35 V, ±20%, 0.200 x 0.435 inch	United ChemiCon	EKY-350ELL330ME11D
C12, C23, C24, C25, C28	5	Capacitor, ceramic, 0.1 µF, 50 V, X7R, ±10%, 0805	Std	Std
C13	1	Capacitor, ceramic, 22 µF, 25 V, X5R, ±20%, 1210	Std	Std
C14	1	Capacitor, aluminum, 100 µF, 25 V, ±20%, 0.200 inch	Nichicon	UHE1E101MED
C17, C27	2	Capacitor, ceramic, 10 nF, 50 V, X7R, ±10%, 0805	Std	Std
C18, C19	2	Capacitor, ceramic, 47 pF, 100 V, C0G, NP0, ±10%, 0805	Std	Std
C20	1	Capacitor, ceramic, 10 µF, 10 V, X7R, ±10%, 1206	Std	Std
C21	1	Capacitor, ceramic disc, 1000 pF, 250 V, Y1, ±20%, 0.394 x 0.315 inch	Panasonic	ECK-ANA102MB
C33	0	Capacitor, ceramic, not populated, 50 V, X7R, ±10%, 0805	Std	Std
D1	1	Diode, power rectifier, 8 A, 400 V, TO-220AC	ON Semiconductor	MUR840G
D2	1	Diode, bridge rectifier, 1.5 A, 600 V, 0.580 x 0.145 inch	Diodes Inc.	KBP06G
D3, D4	2	Diode, switching, 1 A, 600 V, SMA	Diodes Inc.	RS1J-13-F
D5	1	Diode, switching, Dual, 200 mA, 70 V, SOT-23	Fairchild Semiconductor	BAV70
D6	1	Diode, rectifier, 1 A, 1000 V, SMA	Diodes Inc.	US1M-13-F
D7	1	Diode, Zener, 18 V, 350 mW, SOT-23	Diodes Inc.	BZX84C18T-7
D8	1	Diode, Zener, 12 V, 350 mW, SOT-23	Diodes Inc.	BZX84C12-7-F
D9	0	not populated, SMA		
D10, D11, D12, D13, D14	5	Diode, ultra fast rectifier, 1 A, 200 V, SMA	ON Semiconductor	MURA120T3
D15	1	Diode, Zener, 350 mA, 15 V, SOT-23	Diodes Inc.	MMBZ5245B-7-F
D16	1	Diode, Schottky, 1.5 A, 25 V, SMA	Vishay	BYS10-25-E3/TR
D17	1	Diode, Schottky, 200 mA, 30 V, SOT-23	Vishay-Liteon	BAT54
D18	1	Diode, switching, 200 mA, 85 V, 350 mW, SOT-23	Fairchild Semiconductor	BAS16
D19	0	not populated, SOT-23		

Table 3. The EVM Components List According to the Schematic Shown in Figure 1 (continued)

REF DES	COUNT	DESCRIPTION	MFR	PART NUMBER
F1	1	Fuse, slow, 1 A, 250 V, 5 x 20 mm	Std	Std
L1	1	Inductor, common mode, 2.2 mH, 1.5 A, 0.590 x 0.893 inch	Panasonic	ELF-18D228F
L2	1	Inductor, power, 1 mH, 0.6 A, 1.45 W, 0.430 x 0.450 inch	Coilcraft	RFB1010-102L
L3	1	Inductor, SMT, 33 μ H, 1.31 A, 0.166 W, 0.300 sq inch	Coiltronics	DR73-330-R
Q1	1	MOSFET, N-channel, 600 V, 2 A, 4.5 W, TO-220V	Toshiba	2SK3767
Q2, Q3, Q7, Q9	4	Bipolar, NPN, 40 V, 200 mA, 330 mW, SOT-23	Infineon Technologies	MMBT3904LT1
Q4	1	Bipolar, NPN, 80 V, 500 mA, 350 mW, SOT-23	Fairchild Semiconductor	MMBTA06
Q5	1	MOSFET, N-channel, 800 V, 0.9 W, TO-220V	Infineon Technologies	SPA06N80C3
Q6	1	Transistor, PNP, -60 V, -600 mA, 225 mW, SOT-23	ON Semiconductor	MMBT2907ALT1
Q8	1	Bipolar, PNP, 40 V, 200 mA, 250 mW, SOT-23	Infineon Technologies	MMBT3906LT1
R1	1	Resistor, chip, 15 k Ω , 1/2 W, \pm 5%, 2010	Std	Std
R2, R3	2	Resistor, chip, 499 k Ω 1/4 W, \pm 1%, 1206	Std	Std
R4, R8	0	Resistor, chip, not populated, 1 W, \pm 1%, 2512	Std	Std
R5 ⁽¹⁾	1	Resistor, chip, 33 Ω , 1/2 W, \pm 5%, anti-surge, 1210	Panasonic	ERJ-P14J330U
R6, R7, R9, R11, R36, R43	6	Resistor, chip, 1.00 k Ω 1/8 W, \pm 1%, 0805	Std	Std
R10	1	Resistor, metal film, 51 k Ω , 1 W, \pm 5%, 0.130 x 0.600 inch	BC Components	PR01000105102JR500
R12	1	Resistor, chip, 0.39 Ω , 1/2 W, \pm 1%, 1210	Std	Std
R13, R17	2	Resistor, chip, 1 M Ω , 1/4 W, \pm 5%, 1206	Std	Std
R14, R19	0	Resistor, chip, not populated, 1/8 W, \pm 1%, 0805	Std	Std
R15, R24	2	Resistor, chip, 10.0 Ω , 1/4 W, \pm 1%, 1206	Std	Std
R16	1	Resistor, chip, 20.0 Ω , 1/4 W, \pm 1%, 1206	Std	Std
R18	1	Resistor, chip, 3.01 k Ω , 1/8 W, \pm 1%, 0805	Std	Std
R20	1	Resistor, chip, 180 k Ω , 1/8 W, \pm 1%, 0805	Std	Std
R21	1	Resistor, chip, 11.3 k Ω , 1/8 W, \pm 1%, 0805	Std	Std
R22, R26, R30, R35, R38, R39	6	Resistor, chip, 100 k Ω , 1/8 W, \pm 1%, 0805	Std	Std
R23	1	Resistor, chip, 1.00 M Ω , 1/10 W, \pm 1%, 0603	Std	Std
R25, R31, R52	3	Resistor, chip, 10.0 k Ω , 1/8 W, \pm 1%, 0805	Std	Std
R27	1	Resistor, chip, 22.0 k Ω , 1/10 W, \pm 1%, 0603	Std	Std
R28	1	Resistor, chip, 100 Ω , 1/8 W, \pm 1%, 0805	Std	Std
R29, R50	2	Resistor, chip, 20.0 k Ω , 1/8 W, \pm 1%, 0805	Std	Std
R32	1	Resistor, chip, 4.99 k Ω , 1/8 W, \pm 1%, 0805	Std	Std
R33	1	Resistor, axial, 330 Ω , 1/2 W, \pm 5%, 0.300 x 0.100 inch	Panasonic	ERD-S2TJ331V
R34	1	Resistor, chip, 0.62 Ω , 1 W, \pm 1%, 2512	Panasonic	ERJ-1TRQFR62U

⁽¹⁾ All other components can be substituted with equivalent MFG's components.

Table 3. The EVM Components List According to the Schematic Shown in Figure 1 (continued)

REF DES	COUNT	DESCRIPTION	MFR	PART NUMBER
R37, R48	2	Resistor, chip, 249 k Ω , 1/8 W, $\pm 1\%$, 0805	Std	Std
R40	0	Resistor, chip, not populated, 1/10 W, $\pm 1\%$, 0603	Std	Std
R41	1	Resistor, chip, 0 Ω , 1/10 W, $\pm 5\%$, 0603	Std	Std
R42	1	Resistor, chip, 13.3 k Ω , 1/10 W, $\pm 1\%$, 0603	Std	Std
R44	1	Resistor, chip, 5.76 k Ω , 1/10 W, $\pm 1\%$, 0603	Std	Std
R45	1	Resistor, chip, 24.9 k Ω , 1/10 W, $\pm 1\%$, 0603	Std	Std
R46	1	Resistor, chip, 200 k Ω , 1/10 W, $\pm 1\%$, 0603	Std	Std
R47	1	Resistor, chip, 365 k Ω , 1/10 W, $\pm 1\%$, 0603	Std	Std
R49	1	Resistor, chip, 330 Ω , 1/10 W, $\pm 1\%$, 0603	Std	Std
R51	1	Resistor, chip, 49.9 Ω , 1/10 W, $\pm 1\%$, 0603	Std	Std
T1	1	Xfmr., EF25, 240 μ H, N87, 1.122 x 1.161 inch	Vitec or GCi	58P6930 (Vitec) or G084146LF (GCi)
U1 ⁽¹⁾	1	LED lighting power controller, SO-8	Texas Instruments	UCC28810D
U2 ⁽¹⁾	1	50 mA, 24 V _{in} , 5 V _{out} LDO linear regulator, SOP-5 (DCK)	Texas Instruments	TPS71550DCKR
U3	1	Optocoupler, 70 V, 100% CTR, SO-6	Lite-On Inc.	CNY17-3S
U4 ⁽¹⁾	1	Precision dual operational amplifiers, SO-8	Texas Instruments	TLV272CD
U5 ⁽¹⁾	1	Nanopower push-pull output comparators, SOT-23-5 (DBV)	Texas Instruments	TLV3701CDBV
U6 ⁽¹⁾	1	Programmable-delay supervisory circuit, SOT-23-6	Texas Instruments	TPS3808G50DBVR
VR1 ⁽¹⁾	1	Shunt voltage reference, 2.048 V, $\pm 1\%$, SOT-23	Texas Instruments	LM4040D20IDBZR
--	1	PCB, 6.4 ln x 3 ln x 0.062 ln	Any	HPA368

EVALUATION BOARD/KIT IMPORTANT NOTICE

Texas Instruments (TI) provides the enclosed product(s) under the following conditions:

This evaluation board/kit is intended for use for **ENGINEERING DEVELOPMENT, DEMONSTRATION, OR EVALUATION PURPOSES ONLY** and is not considered by TI to be a finished end-product fit for general consumer use. Persons handling the product(s) must have electronics training and observe good engineering practice standards. As such, the goods being provided are not intended to be complete in terms of required design-, marketing-, and/or manufacturing-related protective considerations, including product safety and environmental measures typically found in end products that incorporate such semiconductor components or circuit boards. This evaluation board/kit does not fall within the scope of the European Union directives regarding electromagnetic compatibility, restricted substances (RoHS), recycling (WEEE), FCC, CE or UL, and therefore may not meet the technical requirements of these directives or other related directives.

Should this evaluation board/kit not meet the specifications indicated in the User's Guide, the board/kit may be returned within 30 days from the date of delivery for a full refund. **THE FOREGOING WARRANTY IS THE EXCLUSIVE WARRANTY MADE BY SELLER TO BUYER AND IS IN LIEU OF ALL OTHER WARRANTIES, EXPRESSED, IMPLIED, OR STATUTORY, INCLUDING ANY WARRANTY OF MERCHANTABILITY OR FITNESS FOR ANY PARTICULAR PURPOSE.**

The user assumes all responsibility and liability for proper and safe handling of the goods. Further, the user indemnifies TI from all claims arising from the handling or use of the goods. Due to the open construction of the product, it is the user's responsibility to take any and all appropriate precautions with regard to electrostatic discharge.

EXCEPT TO THE EXTENT OF THE INDEMNITY SET FORTH ABOVE, NEITHER PARTY SHALL BE LIABLE TO THE OTHER FOR ANY INDIRECT, SPECIAL, INCIDENTAL, OR CONSEQUENTIAL DAMAGES.

TI currently deals with a variety of customers for products, and therefore our arrangement with the user **is not exclusive.**

TI assumes **no liability for applications assistance, customer product design, software performance, or infringement of patents or services described herein.**

Please read the User's Guide and, specifically, the Warnings and Restrictions notice in the User's Guide prior to handling the product. This notice contains important safety information about temperatures and voltages. For additional information on TI's environmental and/or safety programs, please contact the TI application engineer or visit www.ti.com/esh.

No license is granted under any patent right or other intellectual property right of TI covering or relating to any machine, process, or combination in which such TI products or services might be or are used.

FCC Warning

This evaluation board/kit is intended for use for **ENGINEERING DEVELOPMENT, DEMONSTRATION, OR EVALUATION PURPOSES ONLY** and is not considered by TI to be a finished end-product fit for general consumer use. It generates, uses, and can radiate radio frequency energy and has not been tested for compliance with the limits of computing devices pursuant to part 15 of FCC rules, which are designed to provide reasonable protection against radio frequency interference. Operation of this equipment in other environments may cause interference with radio communications, in which case the user at his own expense will be required to take whatever measures may be required to correct this interference.

EVM WARNINGS AND RESTRICTIONS

It is important to operate this EVM within the input voltage range of 85 VAC to 265 VAC and the maximum output current of 750 mA.

Exceeding the specified input range may cause unexpected operation and/or irreversible damage to the EVM. If there are questions concerning the input range, please contact a TI field representative prior to connecting the input power.

Applying loads outside of the specified output range may result in unintended operation and/or possible permanent damage to the EVM. Please consult the EVM User's Guide prior to connecting any load to the EVM output. If there is uncertainty as to the load specification, please contact a TI field representative.

During normal operation, some circuit components may have case temperatures greater than 50°C. The EVM is designed to operate properly with certain components above as long as the input and output ranges are maintained. These components include but are not limited to linear regulators, switching transistors, pass transistors, and current sense resistors. These types of devices can be identified using the EVM schematic located in the EVM User's Guide. When placing measurement probes near these devices during operation, please be aware that these devices may be very warm to the touch.

Mailing Address: Texas Instruments, Post Office Box 655303, Dallas, Texas 75265
Copyright © 2009, Texas Instruments Incorporated

IMPORTANT NOTICE

Texas Instruments Incorporated and its subsidiaries (TI) reserve the right to make corrections, modifications, enhancements, improvements, and other changes to its products and services at any time and to discontinue any product or service without notice. Customers should obtain the latest relevant information before placing orders and should verify that such information is current and complete. All products are sold subject to TI's terms and conditions of sale supplied at the time of order acknowledgment.

TI warrants performance of its hardware products to the specifications applicable at the time of sale in accordance with TI's standard warranty. Testing and other quality control techniques are used to the extent TI deems necessary to support this warranty. Except where mandated by government requirements, testing of all parameters of each product is not necessarily performed.

TI assumes no liability for applications assistance or customer product design. Customers are responsible for their products and applications using TI components. To minimize the risks associated with customer products and applications, customers should provide adequate design and operating safeguards.

TI does not warrant or represent that any license, either express or implied, is granted under any TI patent right, copyright, mask work right, or other TI intellectual property right relating to any combination, machine, or process in which TI products or services are used. Information published by TI regarding third-party products or services does not constitute a license from TI to use such products or services or a warranty or endorsement thereof. Use of such information may require a license from a third party under the patents or other intellectual property of the third party, or a license from TI under the patents or other intellectual property of TI.

Reproduction of TI information in TI data books or data sheets is permissible only if reproduction is without alteration and is accompanied by all associated warranties, conditions, limitations, and notices. Reproduction of this information with alteration is an unfair and deceptive business practice. TI is not responsible or liable for such altered documentation. Information of third parties may be subject to additional restrictions.

Resale of TI products or services with statements different from or beyond the parameters stated by TI for that product or service voids all express and any implied warranties for the associated TI product or service and is an unfair and deceptive business practice. TI is not responsible or liable for any such statements.

TI products are not authorized for use in safety-critical applications (such as life support) where a failure of the TI product would reasonably be expected to cause severe personal injury or death, unless officers of the parties have executed an agreement specifically governing such use. Buyers represent that they have all necessary expertise in the safety and regulatory ramifications of their applications, and acknowledge and agree that they are solely responsible for all legal, regulatory and safety-related requirements concerning their products and any use of TI products in such safety-critical applications, notwithstanding any applications-related information or support that may be provided by TI. Further, Buyers must fully indemnify TI and its representatives against any damages arising out of the use of TI products in such safety-critical applications.

TI products are neither designed nor intended for use in military/aerospace applications or environments unless the TI products are specifically designated by TI as military-grade or "enhanced plastic." Only products designated by TI as military-grade meet military specifications. Buyers acknowledge and agree that any such use of TI products which TI has not designated as military-grade is solely at the Buyer's risk, and that they are solely responsible for compliance with all legal and regulatory requirements in connection with such use.

TI products are neither designed nor intended for use in automotive applications or environments unless the specific TI products are designated by TI as compliant with ISO/TS 16949 requirements. Buyers acknowledge and agree that, if they use any non-designated products in automotive applications, TI will not be responsible for any failure to meet such requirements.

Following are URLs where you can obtain information on other Texas Instruments products and application solutions:

Products

Amplifiers	amplifier.ti.com
Data Converters	dataconverter.ti.com
DLP® Products	www.dlp.com
DSP	dsp.ti.com
Clocks and Timers	www.ti.com/clocks
Interface	interface.ti.com
Logic	logic.ti.com
Power Mgmt	power.ti.com
Microcontrollers	microcontroller.ti.com
RFID	www.ti-rfid.com
RF/IF and ZigBee® Solutions	www.ti.com/lprf

Applications

Audio	www.ti.com/audio
Automotive	www.ti.com/automotive
Broadband	www.ti.com/broadband
Digital Control	www.ti.com/digitalcontrol
Medical	www.ti.com/medical
Military	www.ti.com/military
Optical Networking	www.ti.com/opticalnetwork
Security	www.ti.com/security
Telephony	www.ti.com/telephony
Video & Imaging	www.ti.com/video
Wireless	www.ti.com/wireless

Mailing Address: Texas Instruments, Post Office Box 655303, Dallas, Texas 75265
Copyright © 2009, Texas Instruments Incorporated