



The Future of Analog IC Technology®

EVQ4485-U-00A

Step-Down Converter
with Dual USB Charging Ports Supporting
Type-C 5V@3A DFP Mode and BC1.2 CDP
Mode for Automotive, AEC-Q100 Qualified

DESCRIPTION

The MPQ4485 integrates a monolithic step-down switch-mode converter with two USB current-limit switches and charging port identification circuit. It achieves 6A output current over a wide input-supply range with excellent load and line regulation.

The output of the USB switch is current limited. USB1 supports DCP scheme for Battery Charging specification (BC1.2), the Divider Mode, 1.2V/1.2V Mode and USB TYPE-C 5V@3A DFP Mode eliminating outside user interaction. USB2 supports DCP/CDP schemes.

Fault condition protection includes hiccup current limiting, output OVP, and thermal shutdown (TSD).

ELECTRICAL SPECIFICATION

Parameter	Symbol	Value	Units
Operating Input Voltage	V_{IN}	12	V
Switching Frequency	F_s	450	kHz
Output Voltage	V_{USB1}/V_{USB2}	5.17	V
Output Current	USB1_ I _{OUT}	3	A
	USB2_ I _{OUT}	2.5	A

FEATURES

- Wide 6V to 36V Operating Input-Voltage Range
- Fixed 5.17V Output Voltage
- 90mV Line Drop Compensation
- Accurate USB1/USB2 Output-Current Limit
- 18mΩ/15mΩ Low $R_{DS(ON)}$ Internal Buck Power MOSFETs
- 18mΩ/18mΩ Low $R_{DS(ON)}$ Internal USB1/USB2 Power MOSFETs
- USB Output Over-Voltage Protection
- Hiccup Current Limit
- Both ports Support DCP schemes for BC1.2, Divider Mode, and 1.2V/1.2V Mode
- USB1 Supports USB TYPE-C 5V@3A Mode, USB2 Supports CDP Mode

APPLICATIONS

- USB Charging Downstream Port (CDP)
- USB Dedicated Charging Ports (DCP)
- USB Type-C Charging Port

All MPS parts are lead-free, halogen free, and adhere to the RoHS directive. For MPS green status, please visit MPS website under Quality Assurance.

"MPS" and "The Future of Analog IC Technology" are Registered Trademarks of Monolithic Power Systems, Inc.

EVQ4485-U-00A EVALUATION BOARD



(L x W x H) 5cm x 5cm x 1.7cm
(Four Layer PCB/2oz per layer)

Board Number	MPS IC Number
EVQ4485-U-00A	MPQ4485

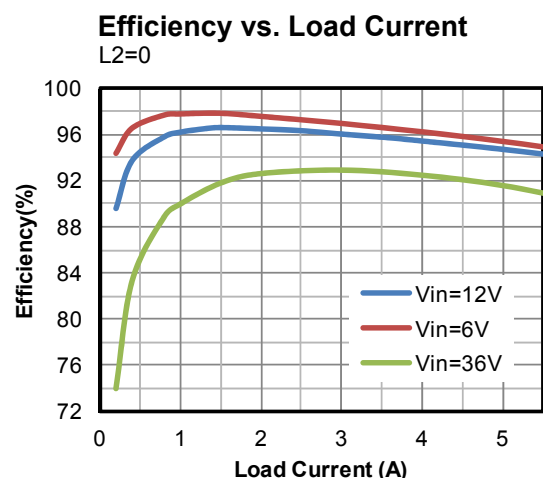

EVALUATION BOARD SCHEMATIC

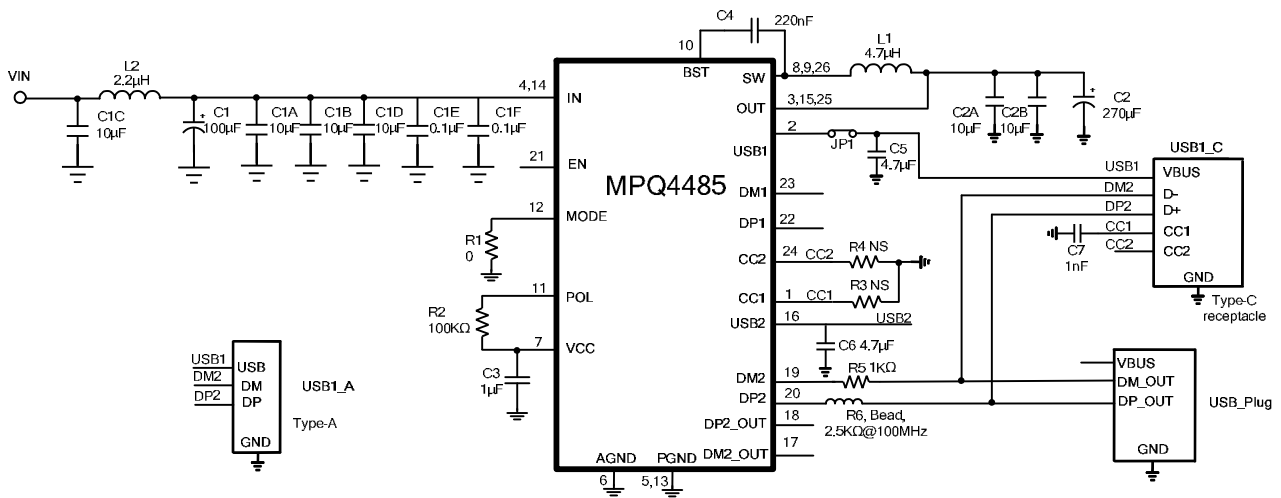

Note: L2 are placed on the bottom side of EVB board.

EVQ4485-U-00A BILL OF MATERIALS

Qty	Ref	Value	Description	Package	Manufacturer	Part Number
4	C1A,C1B,C1C,C1D	10 μ F	Ceramic Capacitor, 50V, X5R	0805	Murata	GRM21BR61H106KE43L
2	C1E, C1F	0.1 μ F	Ceramic Capacitor, 50V, X7R	0402	Samsung	CL05B104KB5NNNC
1	C2	270 μ F	Aluminum Polymer Capacitor, 6.3V	DIP	Chemi-Con	APSK6R3ELL271ME08S
2	C2A, C2B	10 μ F	Ceramic Capacitor, 10V, X7R	0603	Murata	GRM21BR71A106KE51L
2	C5, C6	4.7 μ F	Ceramic Capacitor, 6.3V, X5R	0603	Murata	GRM188R60J475KE19D
1	C3	1 μ F	Ceramic Capacitor, 16V, X7R	0603	Murata	GRM188R71C105KE15D
1	C4	220nF	Ceramic Capacitor, 10V, X7R	0402	Murata	GRM155R71A224KE01D
1	C7	1nF	Ceramic Capacitor, 25V, X7R	0603	Murata	GRM188R71E102KA01D
1	C1	100 μ F	Electrolytic Capacitor, 35V	DIP	Chemi-Con	EMZJ350ADA101MF80G
1	R1	0	Film Resistor, 1%	0603	Yageo	RC0603FR-070RL
0	R3,R4	NS				
1	R2	100K Ω	Film Resistor, 1%	0603	Yageo	RC0603FR-07100KL
1	R5	1K Ω	Film Resistor, 1%	0603	Yageo	RC0603FR-071KL
1	R6	2.5K Ω	Magnetic bead, 2.5K Ω @100MHz	0603	Würth	742792695
1	L1	4.7 μ H	Inductor, 15A Isat, DCR 7m Ω	SMD	Würth	7443551470
1	L2	2.2 μ H	Inductor, 6.2A Isat, DCR 35m Ω	SMD	Würth	74438356022
1	USB1_C	TYPE-C	TYPE-C USB Port	DIP	Würth	632723300011
1	USB1_A	TYPE-A	TYPE-A USB Port	DIP	Würth	61400416021
1	USB_Plug	USB	Single USB Plug	SMD	Würth	629004113921
1	U1	MPQ4485	Step Down Converter with Dual USB Charging Port	QFN26 (5mmx5mm)	MPS	MPQ4485GU
1	JP1	Header	2-Pin, 2.54mm, default all pins short	DIP	Würth	61300211121

TYPICAL PERFORMANCE CHARACTERISTICS

$V_{IN} = 12V$, $V_{OUT} = 5.17V$, $L = 4.7\mu H$, $T_A = 25^\circ C$, set USB1 to Type-C 5V@3A DFP mode, set USB2 to CDP mode, unless otherwise noted.

Output Ripple

USB1_lo = USB2_lo = 0A

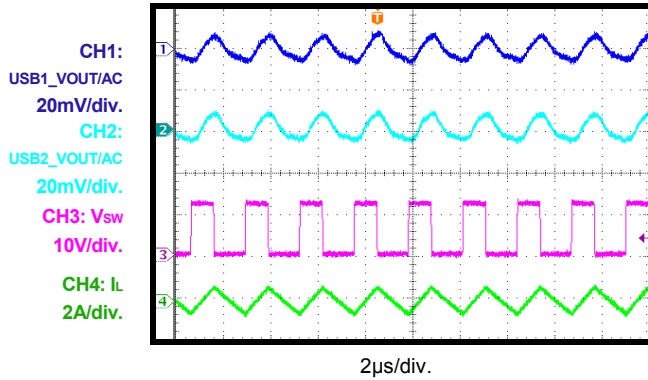

Output Ripple

USB1_lo = 3A, USB2_lo = 2.4A

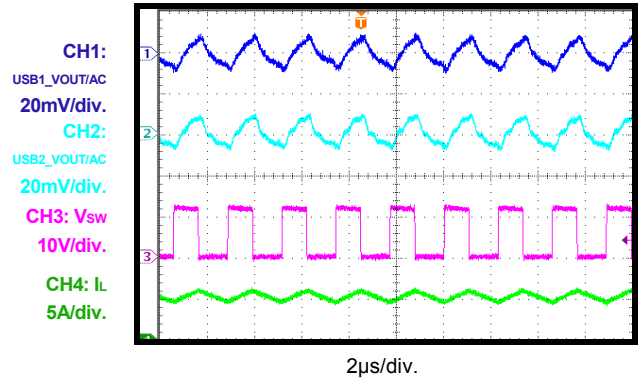

Power Start-Up

USB1_lo = USB2_lo = 0A

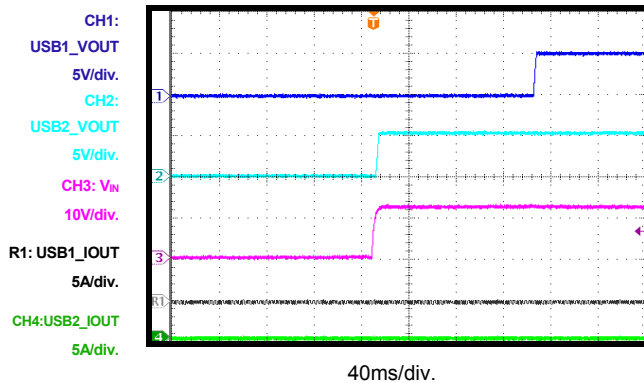

Power Start-Up

USB1_lo = 3A, USB2_lo = 2.4A

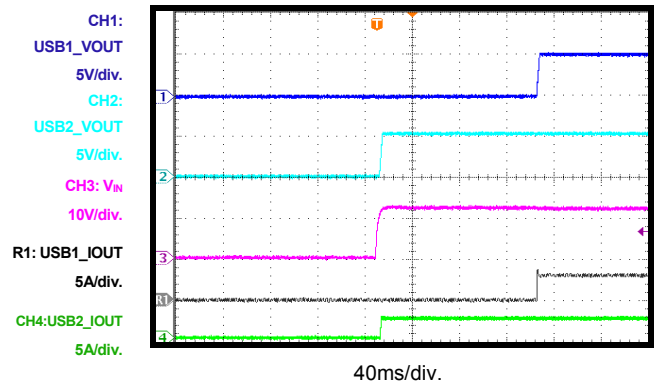

Power Shutdown

USB1_lo = USB2_lo = 0A

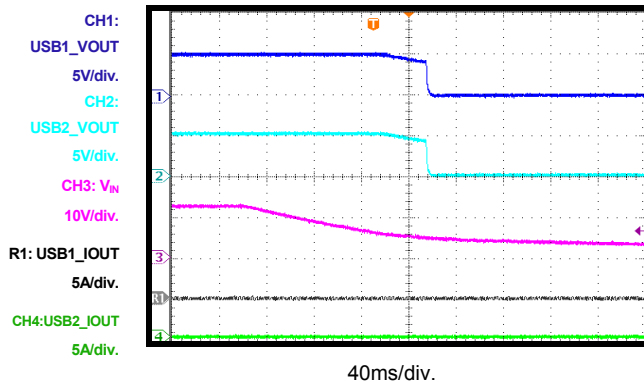

Power Shutdown

USB1_lo = 3A, USB2_lo = 2.4A

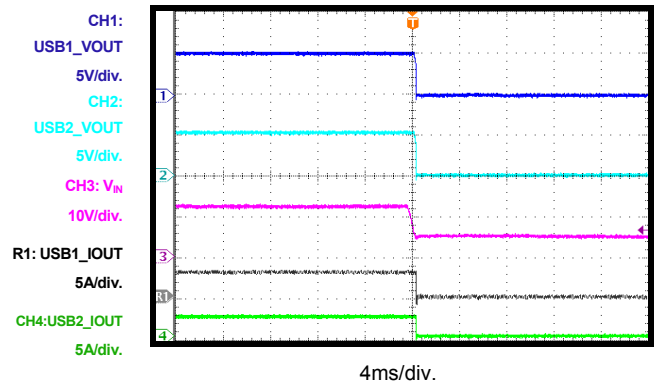

TYPICAL PERFORMANCE CHARACTERISTICS *(continued)*

$V_{IN} = 12V$, $V_{OUT} = 5.17V$, $L = 4.7\mu H$, $T_A = 25^\circ C$, set USB1 to Type-C 5V@3A DFP mode, set USB2 to CDP mode, unless otherwise noted.

Load Shedding Entry (For MPQ4485GU-LS-AEC1 Only)

USB1 $I_o = 0.5A$

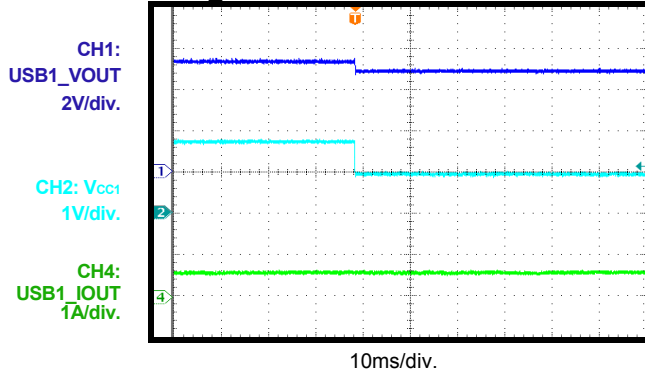

Load Shedding Recovery (For MPQ4485GU-LS-AEC1 Only)

USB1 load current from 0.5A to 0A

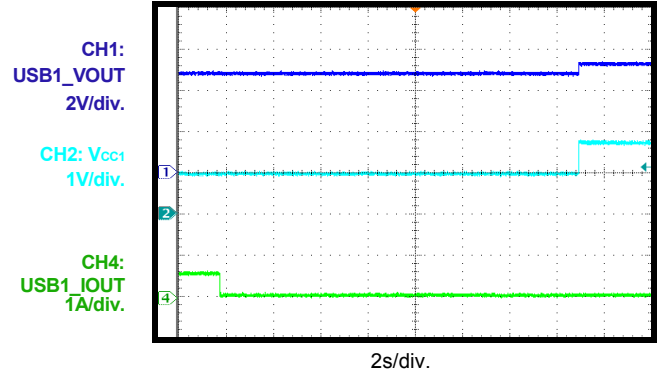

USB1 Over-Current Protection

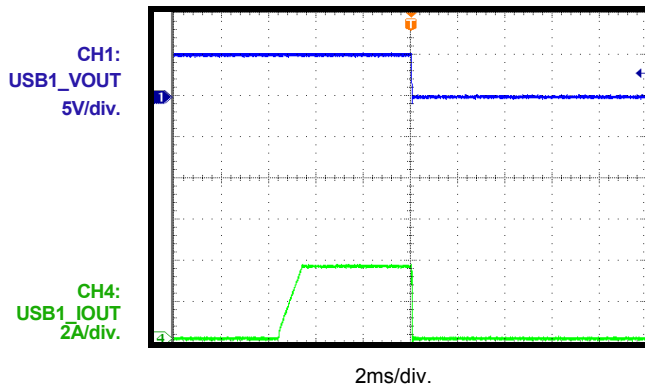

TYPICAL PERFORMANCE CHARACTERISTICS *(continued)*

$V_{IN} = 12V$, $V_{OUT} = 5.17V$, $L = 4.7\mu H$, $T_A = 25^\circ C$, set USB1 to Type-C 5V@3A DFP mode, set USB2 to CDP mode, unless otherwise noted.

Efficiency vs. Load Current

L2 = 0

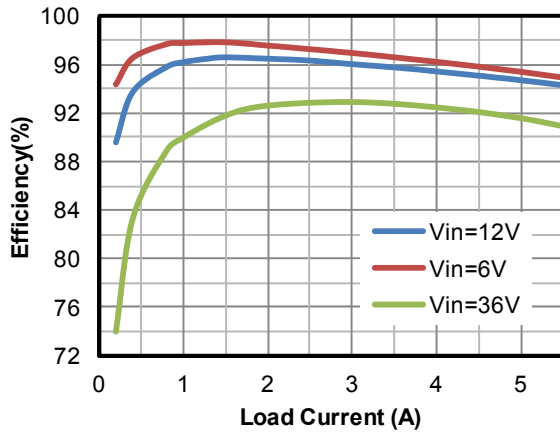
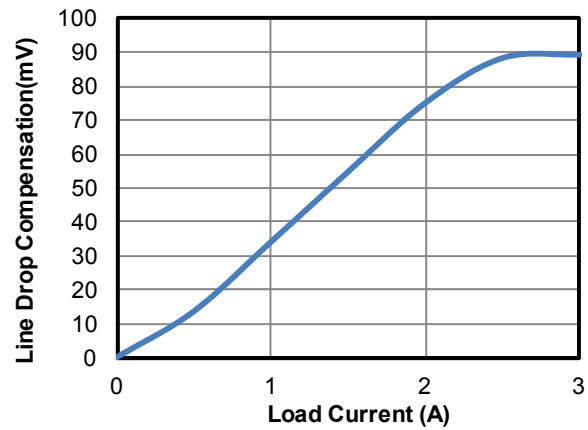
Line Drop Compensation vs. Load Current

Thermal Image

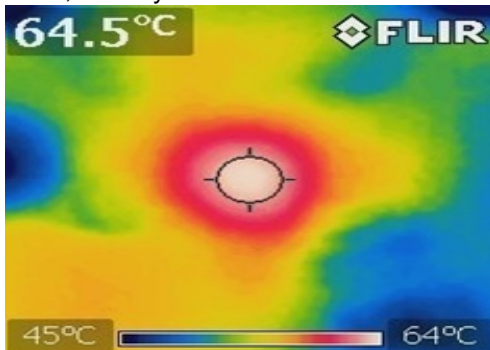
$V_{IN} = 12V$, USB1_IOUT = USB2_IOUT = 2.4A, four-layer PCB

Thermal Image

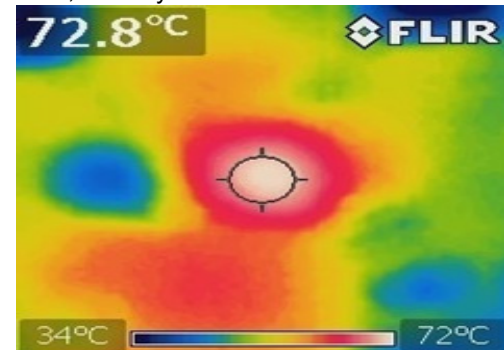
$V_{IN} = 12V$, USB1_IOUT = 3A, USB2_IOUT = 2.4A, four-layer PCB

USB2 Eye Pattern Test

Recommended CDP mode set-up

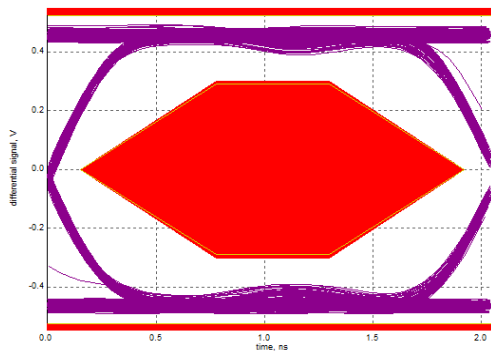

PRINTED CIRCUIT BOARD LAYOUT

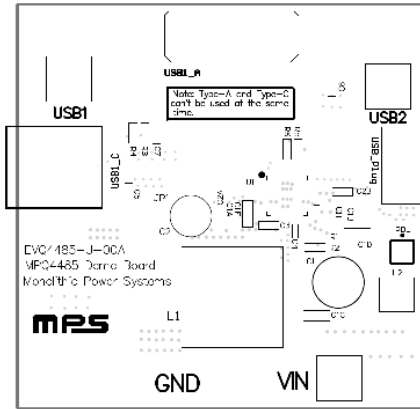

Figure 1—Top Silk Layer

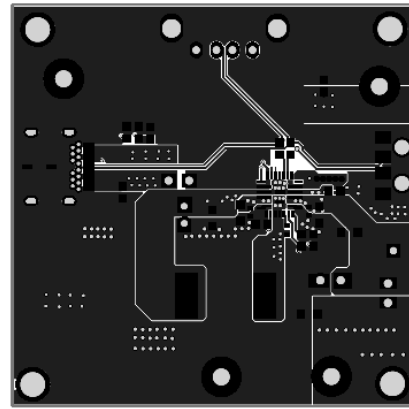

Figure 2—Top Layer

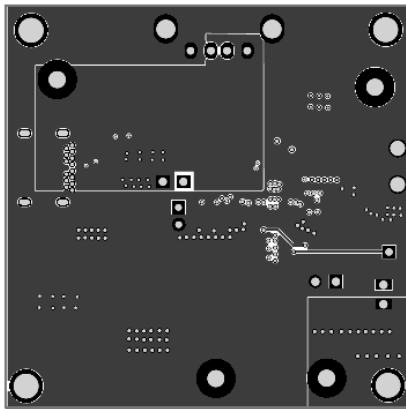

Figure 3—Middle1 Layer

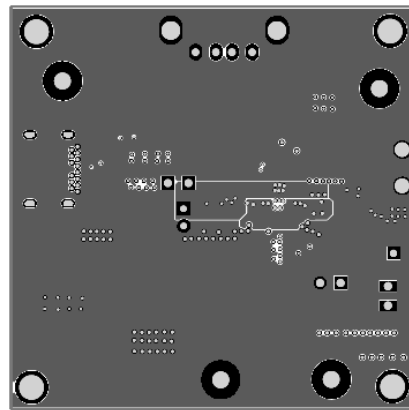

Figure 4—Middle2 Layer

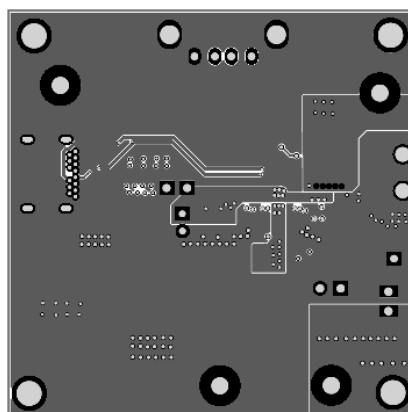

Figure 5—Bottom Layer

QUICK START GUIDE

1. Connect the positive and negative terminals of the load to the USB1, USB2 and GND pins, respectively.
2. Preset the power supply output between 6V and 36V, and then turn off the power supply.
3. Connect the positive and negative terminals of the power supply output to the VIN and GND pins, respectively.
4. Turn the power supply on, the board will automatically start up. But if no type-C device is attached, there is no Vbus output.
5. For default setup, USB1 is at 5V/3A Type-C mode supporting CDP mode detection; USB2 supports 5V/2.5A power output without mode detection.
6. For USB1 Type-C port data transmission test, customer can plug mobile device into Type-C receptacle and connect USB_Plug to host controller.
7. For Type-A port data transmission test, remove C7, change R3 =80.6K Ω , keep R4 floating.
8. Type-A and Type-C port can't be used at the same time.

NOTICE: The information in this document is subject to change without notice. Please contact MPS for current specifications. Users should warrant and guarantee that third party Intellectual Property rights are not infringed upon when integrating MPS products into any application. MPS will not assume any legal responsibility for any said applications.