



# 1.2W, Low-EMI, Filterless, Class D Audio Amplifier

MAX9700

## General Description

The MAX9700 mono class D audio power amplifier provides class AB amplifier performance with class D efficiency, conserving board space and extending battery life. Using a class D architecture, the MAX9700 delivers 1.2W into an 8Ω load while offering efficiencies above 90%. A low-EMI modulation scheme renders the traditional class D output filter unnecessary.

The MAX9700 offers two modulation schemes: a fixed-frequency (FFM) mode, and a spread-spectrum (SSM) mode that reduces EMI-radiated emissions due to the modulation frequency. Furthermore, the MAX9700 oscillator can be synchronized to an external clock through the SYNC input, allowing the switching frequency to be user defined. The SYNC input also allows multiple MAX9700s to be cascaded and frequency locked, minimizing interference due to clock intermodulation. The device utilizes a fully differential architecture, a full-bridged output, and comprehensive click-and-pop suppression. The gain of the MAX9700 is set internally (MAX9700A: 6dB, MAX9700B: 12dB, MAX9700C: 15.6dB, MAX9700D: 20dB), further reducing external component count.

The MAX9700 features high 72dB PSRR, a low 0.01% THD+N, and SNR in excess of 90dB. Short-circuit and thermal-overload protection prevent the device from damage during a fault condition. The MAX9700 is available in 10-pin TDFN (3mm × 3mm × 0.8mm), 10-pin μMAX®, and 12-bump UCSP™ (1.5mm × 2mm × 0.6mm) packages. The MAX9700 is specified over the extended -40°C to +85°C temperature range.

## Applications

Cellular Phones      MP3 Players  
PDAs                      Portable Audio

## Block Diagram

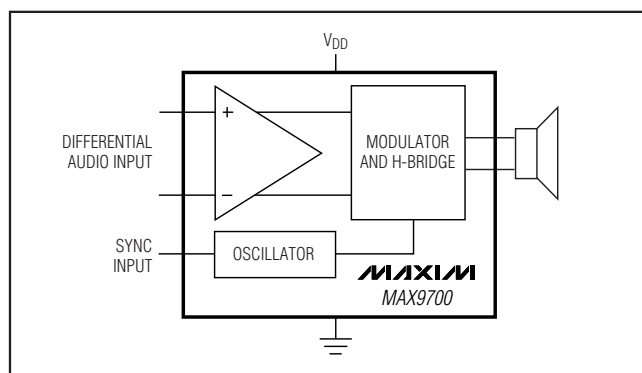

UCSP is a trademark of Maxim Integrated Products, Inc.  
μMAX is a registered trademark of Maxim Integrated Products, Inc.

## Features

- ◆ Filterless Amplifier Passes FCC Radiated Emissions Standards with 100mm of Cable
- ◆ Unique Spread-Spectrum Mode Offers 5dB Emissions Improvement Over Conventional Methods
- ◆ Optional External SYNC Input
- ◆ Simple Master-Slave Setup for Stereo Operation
- ◆ 94% Efficiency
- ◆ 1.2W into 8Ω
- ◆ Low 0.01% THD+N
- ◆ High PSRR (72dB at 217Hz)
- ◆ Integrated Click-and-Pop Suppression
- ◆ Low Quiescent Current (4mA)
- ◆ Low-Power Shutdown Mode (0.1μA)
- ◆ Short-Circuit and Thermal-Overload Protection
- ◆ Available in Thermally Efficient, Space-Saving Packages
  - 10-Pin TDFN (3mm x 3mm x 0.8mm)
  - 10-Pin μMAX
  - 12-Bump UCSP (1.5mm x 2mm x 0.6mm)

## Ordering Information

PART	TEMP RANGE	PIN-PACKAGE	TOP MARK
MAX9700AETB	-40°C to +85°C	10 TDFN-EP*	ACM
MAX9700AEUB	-40°C to +85°C	10 μMAX	—
MAX9700AEBC-T	-40°C to +85°C	12 UCSP	—
MAX9700BETB	-40°C to +85°C	10 TDFN-EP*	ACI
MAX9700BEUB	-40°C to +85°C	10 μMAX	—
MAX9700BEBC-T	-40°C to +85°C	12 UCSP	—

\*EP = Exposed pad.

Ordering Information continued and Selector Guide appears at end of data sheet.

## Pin Configurations

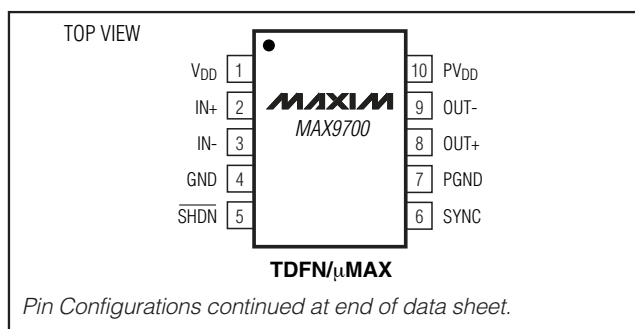

Pin Configurations continued at end of data sheet.



# 1.2W, Low-EMI, Filterless, Class D Audio Amplifier

## ABSOLUTE MAXIMUM RATINGS

V <sub>DD</sub> to GND	6V	Continuous Power Dissipation (T <sub>A</sub> = +70°C)	
PV <sub>DD</sub> to PGND	6V	10-Pin TDFN (derate 24.4mW/°C above +70°C)	1951.2mW
GND to PGND	-0.3V to +0.3V	10-Pin μMAX (derate 5.6mW/°C above +70°C)	444.4mW
All Other Pins to GND	-0.3V to (V <sub>DD</sub> + 0.3V)	12-Bump UCSP (derate 6.1mW/°C above +70°C)	484mW
Continuous Current Into/Out of PV <sub>DD</sub> /PGND/OUT	±600mA	Junction Temperature	+150°C
Continuous Input Current (all other pins)	±20mA	Operating Temperature Range	-40°C to +85°C
Duration of OUT_ Short Circuit to GND or PV <sub>DD</sub>	Continuous	Storage Temperature Range	-65°C to +150°C
Duration of Short Circuit Between OUT+ and OUT-	Continuous	Lead Temperature (soldering, 10s)	+300°C
		Bump Temperature (soldering)	+235°C
		Reflow	+235°C

Stresses beyond those listed under "Absolute Maximum Ratings" may cause permanent damage to the device. These are stress ratings only, and functional operation of the device at these or any other conditions beyond those indicated in the operational sections of the specifications is not implied. Exposure to absolute maximum rating conditions for extended periods may affect device reliability.

## ELECTRICAL CHARACTERISTICS

(V<sub>DD</sub> = PV<sub>DD</sub> = V<sub>SHDN</sub> = 3.3V, V<sub>GND</sub> = V<sub>PGND</sub> = 0V, SYNC = GND (FFM), R<sub>L</sub> = 8Ω, R<sub>L</sub> connected between OUT+ and OUT-, T<sub>A</sub> = T<sub>MIN</sub> to T<sub>MAX</sub>, unless otherwise noted. Typical values are at T<sub>A</sub> = +25°C.) (Notes 1, 2)

PARAMETER	SYMBOL	CONDITIONS	MIN	TYP	MAX	UNITS
<b>GENERAL</b>						
Supply Voltage Range	V <sub>DD</sub>	Inferred from PSRR test	2.5		5.5	V
Quiescent Current	I <sub>DD</sub>			4	5.2	mA
Shutdown Current	I <sub>SHDN</sub>			0.1	10	μA
Turn-On Time	t <sub>ON</sub>			30		ms
Input Resistance	R <sub>IN</sub>	T <sub>A</sub> = +25°C	12	20		kΩ
Input Bias Voltage	V <sub>BIAS</sub>	Either input	0.73	0.83	0.93	V
Voltage Gain	A <sub>V</sub>	MAX9700A		6		dB
		MAX9700B		12		
		MAX9700C		15.6		
		MAX9700D		20		
Output Offset Voltage	V <sub>OS</sub>	T <sub>A</sub> = +25°C		±11	±80	mV
		T <sub>MIN</sub> ≤ T <sub>A</sub> ≤ T <sub>MAX</sub>			±120	
Common-Mode Rejection Ratio	CMRR	f <sub>IN</sub> = 1kHz, input referred		72		dB
Power-Supply Rejection Ratio (Note 3)	PSRR	V <sub>DD</sub> = 2.5V to 5.5V, T <sub>A</sub> = +25°C	50	70		dB
		200mV <sub>p-p</sub> ripple				
Output Power	P <sub>OUT</sub>	THD+N = 1%	R <sub>L</sub> = 8Ω		450	mW
			R <sub>L</sub> = 6Ω		800	
Total Harmonic Distortion Plus Noise	THD+N	f <sub>IN</sub> = 1kHz, either FFM or SSM	R <sub>L</sub> = 8Ω, P <sub>OUT</sub> = 125mW		0.01	%
			R <sub>L</sub> = 6Ω, P <sub>OUT</sub> = 125mW		0.01	

# 1.2W, Low-EMI, Filterless, Class D Audio Amplifier

MAX9700

## ELECTRICAL CHARACTERISTICS (continued)

( $V_{DD} = PV_{DD} = V_{SHDN} = 3.3V$ ,  $V_{GND} = V_{PGND} = 0V$ , SYNC = GND (FFM),  $R_L = 8\Omega$ ,  $R_L$  connected between OUT+ and OUT-,  $T_A = T_{MIN}$  to  $T_{MAX}$ , unless otherwise noted. Typical values are at  $T_A = +25^\circ C$ .) (Notes 1, 2)

PARAMETER	SYMBOL	CONDITIONS		MIN	TYP	MAX	UNITS
Signal-to-Noise Ratio	SNR	$V_{OUT} = 2V_{RMS}$	BW = 22Hz to 22kHz	FFM	89		dB
				SSM	87		
			A-weighted	FFM	92		
				SSM	90		
Oscillator Frequency	$f_{OSC}$	SYNC = GND		980	1100	1220	kHz
		SYNC = unconnected		1280	1450	1620	
		SYNC = $V_{DD}$ (SSM mode)			1220	$\pm 120$	
SYNC Frequency Lock Range				800		2000	kHz
Efficiency	$\eta$	$P_{OUT} = 500mW$ , $f_{IN} = 1kHz$			94		%
<b>DIGITAL INPUTS (<math>\overline{SHDN}</math>, SYNC)</b>							
Input Thresholds		$V_{IH}$		2			V
		$V_{IL}$				0.8	
$\overline{SHDN}$ Input Leakage Current						$\pm 1$	$\mu A$
SYNC Input Current						$\pm 5$	$\mu A$

## ELECTRICAL CHARACTERISTICS

( $V_{DD} = PV_{DD} = V_{SHDN} = 5V$ ,  $V_{GND} = V_{PGND} = 0V$ , SYNC = GND (FFM),  $R_L = 8\Omega$ ,  $R_L$  connected between OUT+ and OUT-,  $T_A = T_{MIN}$  to  $T_{MAX}$ , unless otherwise noted. Typical values are at  $T_A = +25^\circ C$ .) (Notes 1, 2)

PARAMETER	SYMBOL	CONDITIONS		MIN	TYP	MAX	UNITS
Quiescent Current	$I_{DD}$				5.2		mA
Shutdown Current	$I_{SHDN}$				0.1		$\mu A$
Common-Mode Rejection Ratio	CMRR	$f = 1kHz$ , input referred			72		dB
Power-Supply Rejection Ratio	PSRR	200mV <sub>P-P</sub> ripple	$f = 217Hz$		72		dB
			$f = 20kHz$		55		
Output Power	$P_{OUT}$	THD+N = 1%	$R_L = 16\Omega$		700		mW
			$R_L = 8\Omega$		1200		
			$R_L = 6\Omega$		1600		
Total Harmonic Distortion Plus Noise	THD+N	$f = 1kHz$ , either FFM or SSM	$R_L = 8\Omega$ , $P_{OUT} = 125mW$		0.015		%
			$R_L = 4\Omega$ , $P_{OUT} = 125mW$		0.02		
Signal-to-Noise Ratio	SNR	$V_{OUT} = 3V_{RMS}$	BW = 22Hz to 22kHz	FFM	92.5		dB
				SSM	90.5		
			A-weighted	FFM	95.5		
				SSM	93.5		

**Note 1:** All devices are 100% production tested at  $T_A = +25^\circ C$ . All temperature limits are guaranteed by design.

**Note 2:** Testing performed with a resistive load in series with an inductor to simulate an actual speaker load. For  $R_L = 4\Omega$ ,  $L = 33\mu H$ . For  $R_L = 8\Omega$ ,  $L = 68\mu H$ . For  $R_L = 16\Omega$ ,  $L = 136\mu H$ .

**Note 3:** PSRR is specified with the amplifier inputs connected to GND through  $C_{IN}$ .

# 1.2W, Low-EMI, Filterless, Class D Audio Amplifier

## Typical Operating Characteristics

( $V_{DD} = 3.3V$ , SYNC = GND (SSM),  $T_A = +25^\circ C$ , unless otherwise noted.)

**TOTAL HARMONIC DISTORTION PLUS NOISE vs. FREQUENCY**

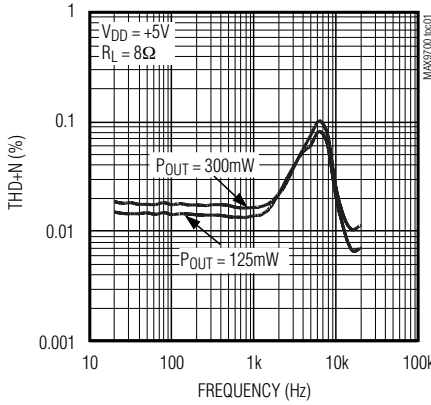

**TOTAL HARMONIC DISTORTION PLUS NOISE vs. FREQUENCY**

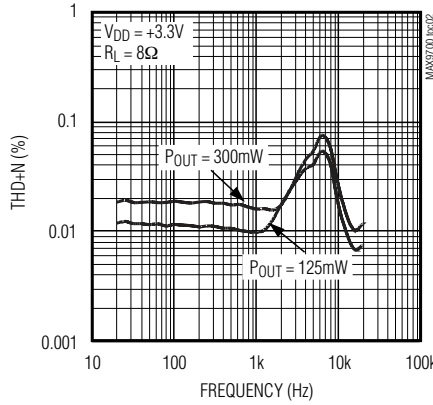

**TOTAL HARMONIC DISTORTION PLUS NOISE vs. FREQUENCY**

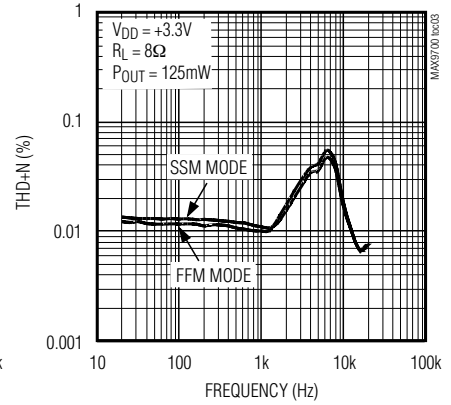

**TOTAL HARMONIC DISTORTION PLUS NOISE vs. OUTPUT POWER**

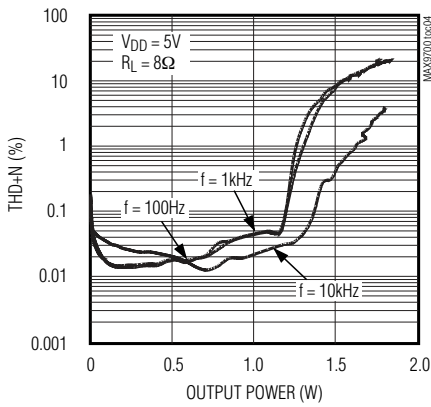

**TOTAL HARMONIC DISTORTION PLUS NOISE vs. OUTPUT POWER**

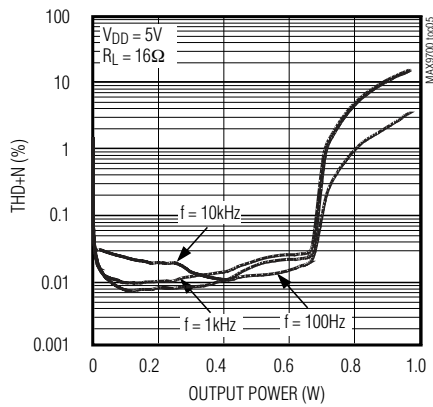

**TOTAL HARMONIC DISTORTION PLUS NOISE vs. OUTPUT VOLTAGE**

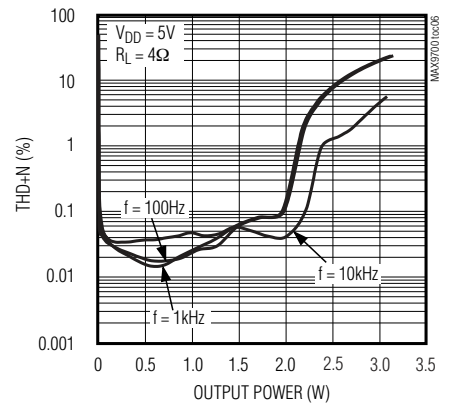

**TOTAL HARMONIC DISTORTION PLUS NOISE vs. OUTPUT POWER**

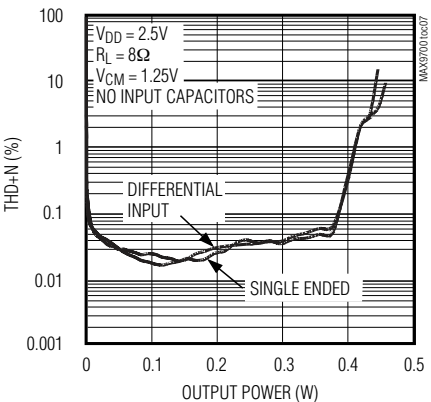

**TOTAL HARMONIC DISTORTION PLUS NOISE vs. OUTPUT POWER**

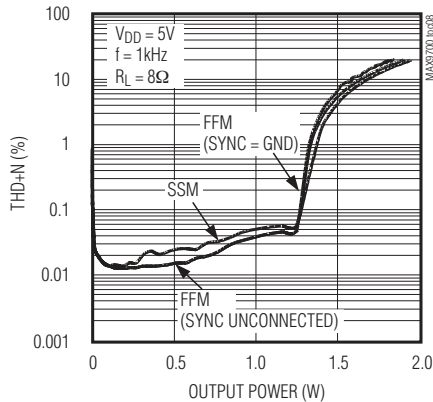

**TOTAL HARMONIC DISTORTION PLUS NOISE vs. OUTPUT POWER**

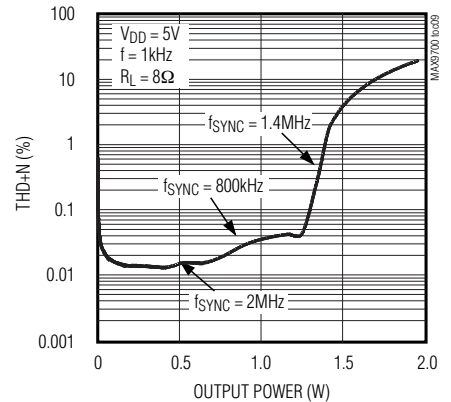

# 1.2W, Low-EMI, Filterless, Class D Audio Amplifier

MAX9700

## Typical Operating Characteristics (continued)

( $V_{DD} = 3.3V$ , SYNC = GND (SSM),  $T_A = +25^\circ C$ , unless otherwise noted.)

**TOTAL HARMONIC DISTORTION PLUS NOISE vs. COMMON-MODE VOLTAGE**

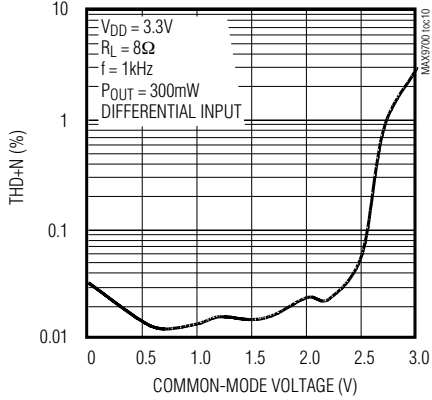

**EFFICIENCY vs. OUTPUT POWER**

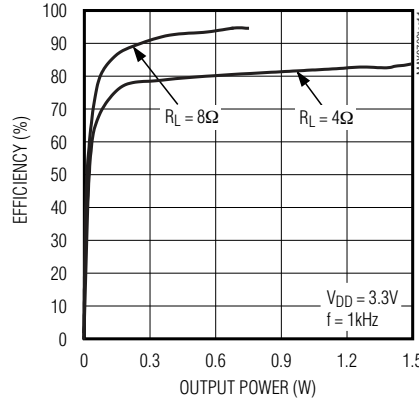

**EFFICIENCY vs. OUTPUT POWER**

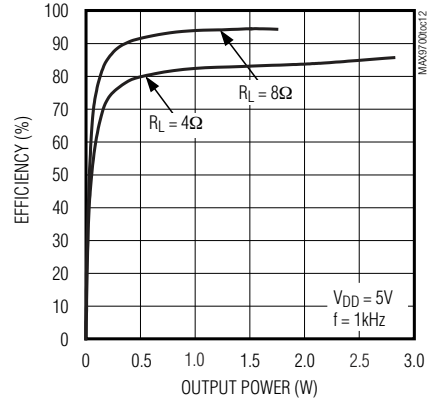

**EFFICIENCY vs. SUPPLY VOLTAGE**

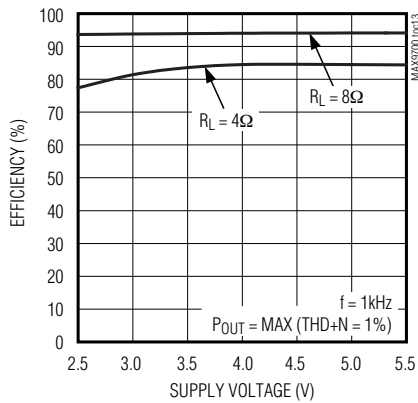

**EFFICIENCY vs. SYNC INPUT FREQUENCY**

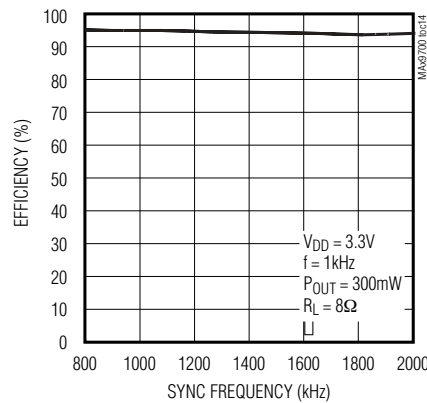

**OUTPUT POWER vs. SUPPLY VOLTAGE**

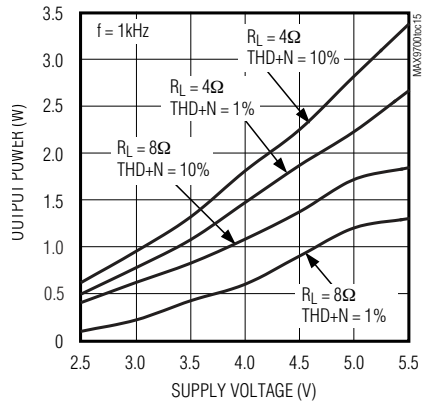

**OUTPUT POWER vs. LOAD RESISTANCE**

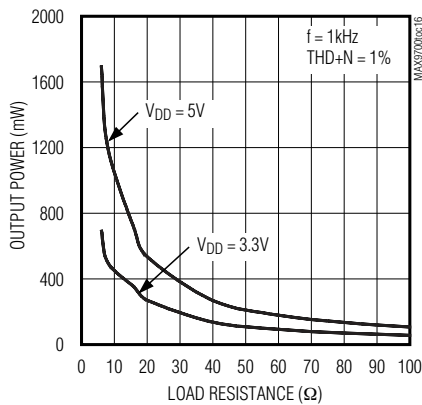

**COMMON-MODE REJECTION RATIO vs. FREQUENCY**

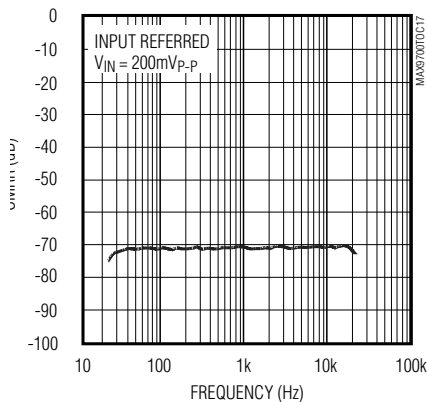

**POWER-SUPPLY REJECTION RATIO vs. FREQUENCY**

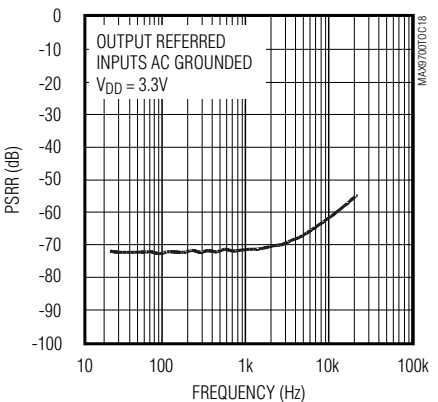

# 1.2W, Low-EMI, Filterless, Class D Audio Amplifier

## Typical Operating Characteristics (continued)

( $V_{DD} = 3.3V$ , SYNC = GND (SSM),  $T_A = +25^\circ C$ , unless otherwise noted.)

**GSM POWER-SUPPLY REJECTION**  
MAX9700 toc19

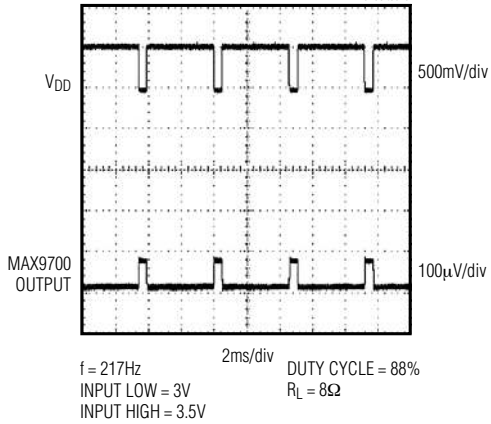

**OUTPUT FREQUENCY SPECTRUM**

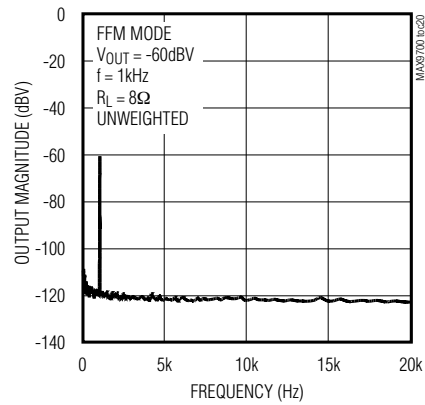

**OUTPUT FREQUENCY SPECTRUM**

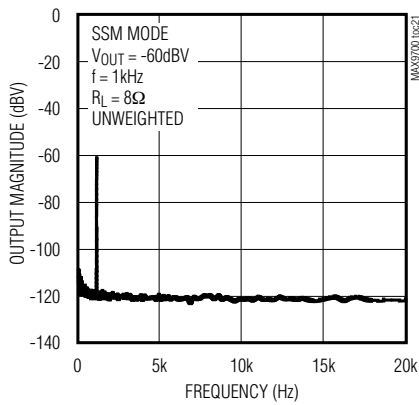

**OUTPUT FREQUENCY SPECTRUM**

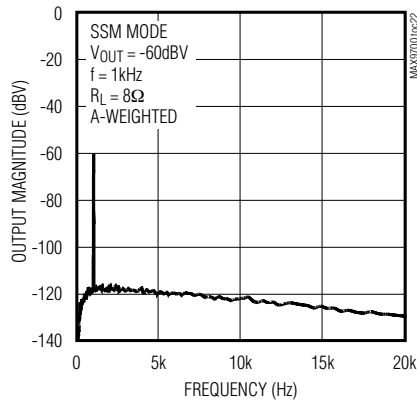

**WIDEBAND OUTPUT SPECTRUM (FFM MODE)**

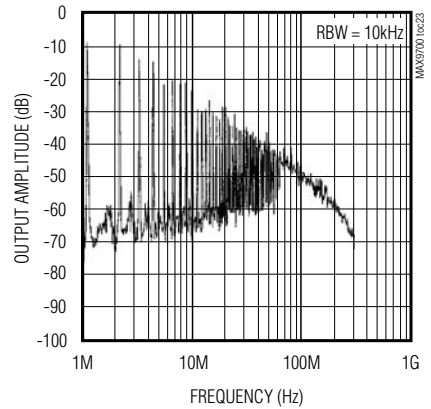

**WIDEBAND OUTPUT SPECTRUM (SSM MODE)**

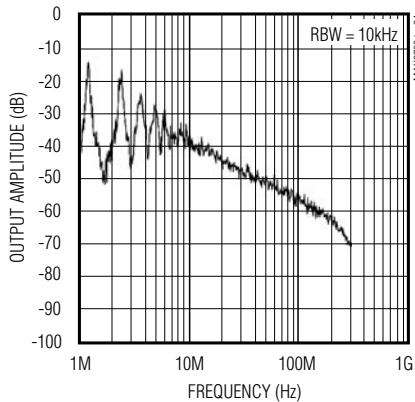

**TURN-ON/TURN-OFF RESPONSE**

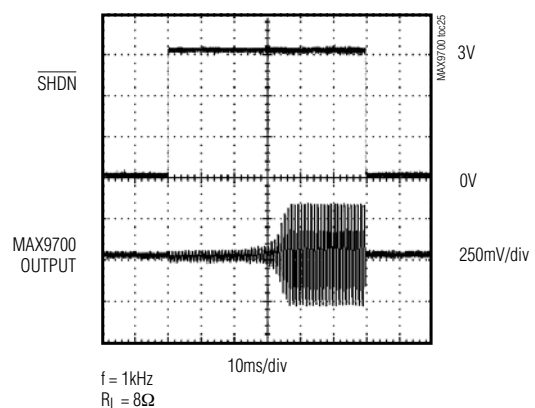

# 1.2W, Low-EMI, Filterless, Class D Audio Amplifier

MAX9700

## Typical Operating Characteristics (continued)

( $V_{DD} = 3.3V$ ,  $SYNC = GND$  (SSM),  $T_A = +25^\circ C$ , unless otherwise noted.)

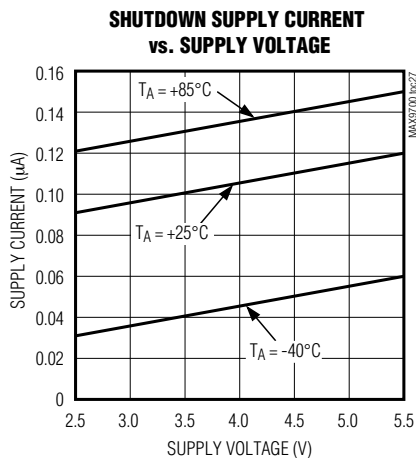
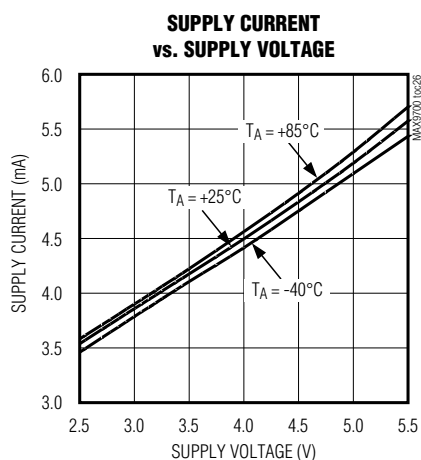

## Functional Diagram

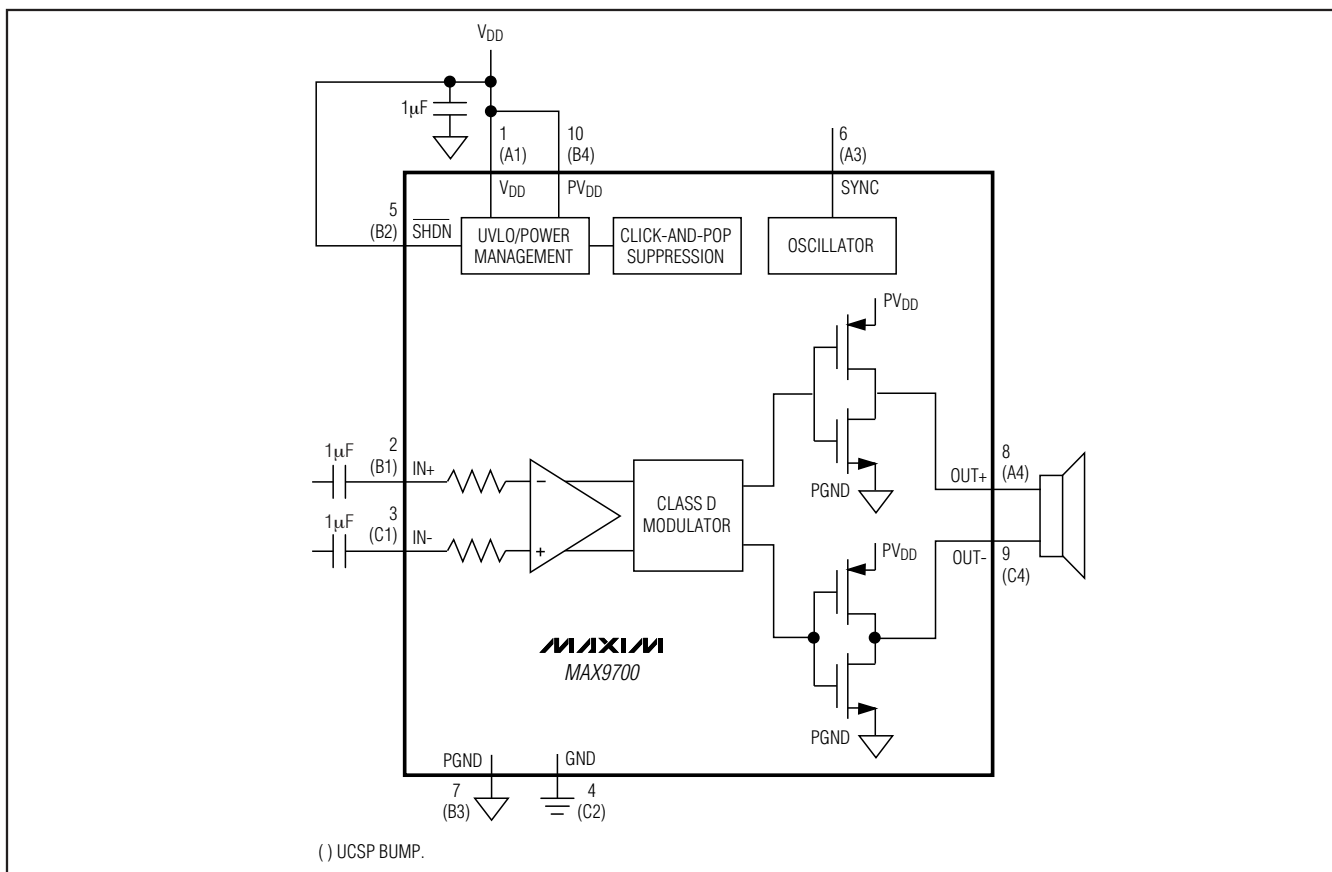

# 1.2W, Low-EMI, Filterless, Class D Audio Amplifier

## Pin Description

PIN	BUMP	NAME	FUNCTION
TDFN/ $\mu$ MAX	UCSP		
1	A1	V <sub>DD</sub>	Analog Power Supply. Connect to an external power supply. Bypass to GND with a 1 $\mu$ F capacitor.
2	B1	IN+	Noninverting Audio Input
3	C1	IN-	Inverting Audio Input
4	C2	GND	Analog Ground
5	B2	SHDN	Active-Low Shutdown Input. Connect to V <sub>DD</sub> for normal operation.
6	A3	SYNC	Frequency Select and External Clock Input. <b>SYNC = GND:</b> Fixed-frequency mode with $f_S = 1100\text{kHz}$ . <b>SYNC = Unconnected:</b> Fixed-frequency mode with $f_S = 1450\text{kHz}$ . <b>SYNC = V<sub>DD</sub>:</b> Spread-spectrum mode with $f_S = 1220\text{kHz} \pm 120\text{kHz}$ . <b>SYNC = Clocked:</b> Fixed-frequency mode with $f_S = \text{external clock frequency}$ .
7	B3	PGND	Power Ground
8	A4	OUT+	Amplifier-Output Positive Phase
9	C4	OUT-	Amplifier-Output Negative Phase
10	B4	PV <sub>DD</sub>	H-Bridge Power Supply. Connect to V <sub>DD</sub> .
—	—	EP	Exposed Pad. Internally connected to GND. Connect to a large ground plane to maximize thermal performance. Not intended as an electrical connection point. (TDFN package only.)

## Detailed Description

The MAX9700 filterless, class D audio power amplifier features several improvements to switch-mode amplifier technology. The MAX9700 offers class AB performance with class D efficiency, while occupying minimal board space. A unique filterless modulation scheme, synchronizable switching frequency, and SSM mode create a compact, flexible, low-noise, efficient audio power amplifier. The differential input architecture reduces common-mode noise pickup, and can be used without input-coupling capacitors. The device can also be configured as a single-ended input amplifier.

Comparators monitor the MAX9700 inputs and compare the complementary input voltages to the sawtooth waveform. The comparators trip when the input magnitude of the sawtooth exceeds their corresponding input voltage. Both comparators reset at a fixed time after the rising edge of the second comparator trip point, generating a minimum-width pulse  $t_{ON(MIN)}$  at the output of the second comparator (Figure 1). As the input voltage increases or decreases, the duration of the pulse at one output increases (the first comparator to trip) while the other output pulse duration remains at  $t_{ON(MIN)}$ . This causes the net voltage across the speaker ( $V_{OUT+} - V_{OUT-}$ ) to change.

## Operating Modes

### Fixed-Frequency Modulation (FFM) Mode

The MAX9700 features two FFM modes. The FFM modes are selected by setting SYNC = GND for a 1.1MHz switching frequency, and SYNC = UNCONNECTED for a 1.45MHz switching frequency. In FFM mode, the frequency spectrum of the class D output consists of the fundamental switching frequency and its associated harmonics (see the Wideband FFT graph in the *Typical Operating Characteristics*). The MAX9700 allows the switching frequency to be changed by +32%, should the frequency of one or more of the harmonics fall in a sensitive band. This can be done at any time and does not affect audio reproduction.

### Spread-Spectrum Modulation (SSM) Mode

The MAX9700 features a unique spread-spectrum mode that flattens the wideband spectral components, improving EMI emissions that may be radiated by the speaker and cables by 5dB. Proprietary techniques ensure that the cycle-to-cycle variation of the switching period does not degrade audio reproduction or efficiency (see the *Typical Operating Characteristics*). Select SSM mode by setting SYNC = V<sub>DD</sub>. In SSM mode, the switching frequency varies randomly by  $\pm 120\text{kHz}$  around the center frequency (1.22MHz). The modulation



# 1.2W, Low-EMI, Filterless, Class D Audio Amplifier

MAX9700

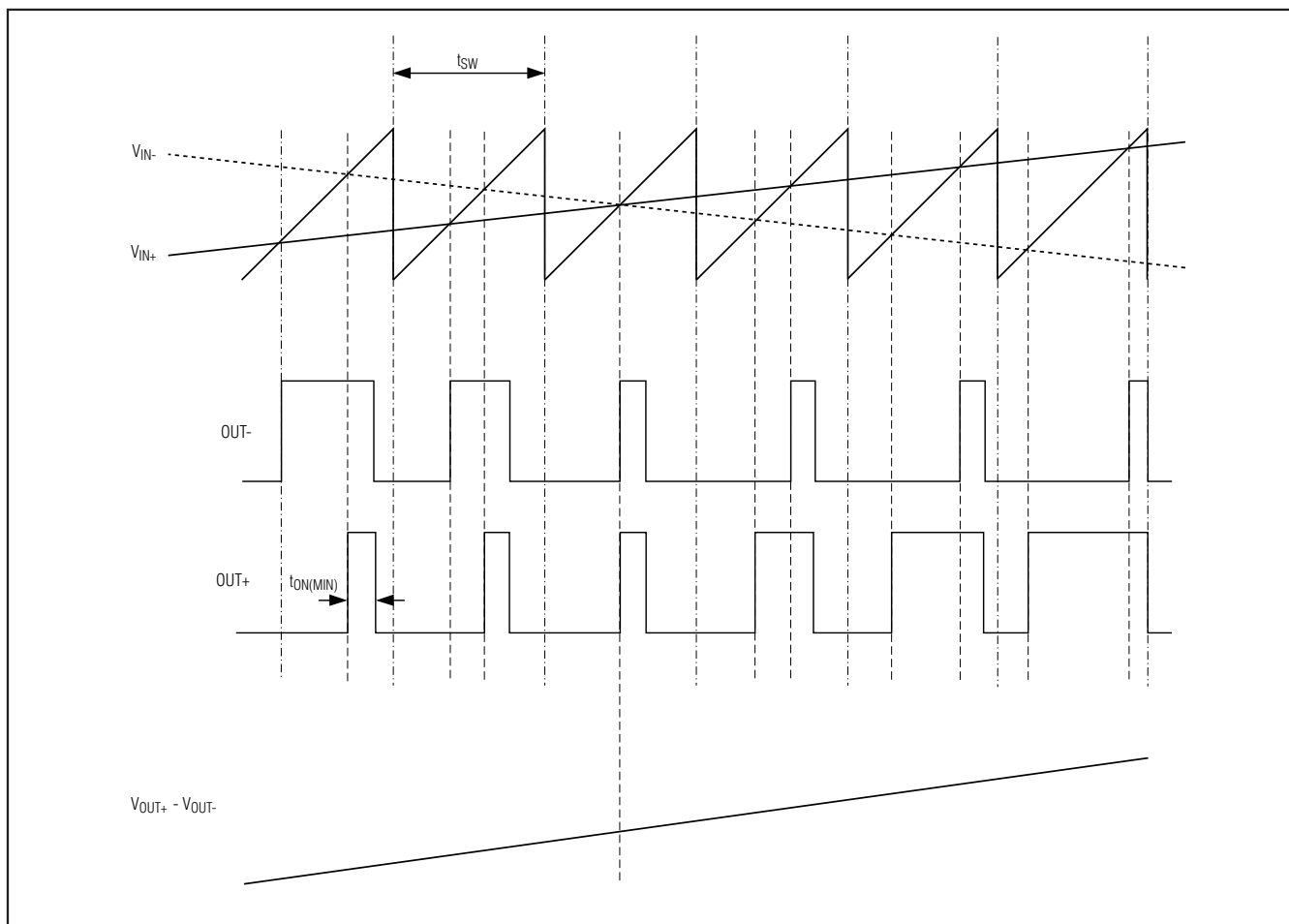

Figure 1. MAX9700 Outputs with an Input Signal Applied

Table 1. Operating Modes

SYNC INPUT	MODE
GND	FFM with $f_S = 1100\text{kHz}$
UNCONNECTED	FFM with $f_S = 1450\text{kHz}$
$V_{DD}$	SSM with $f_S = 1220\text{kHz} \pm 120\text{kHz}$
Clocked	FFM with $f_S = \text{external clock frequency}$

scheme remains the same, but the period of the sawtooth waveform changes from cycle to cycle (Figure 2). Instead of a large amount of spectral energy present at multiples of the switching frequency, the energy is now spread over a bandwidth that increases with frequency. Above a few megahertz, the wideband spectrum looks like white noise for EMI purposes (Figure 3).

### External Clock Mode

The SYNC input allows the MAX9700 to be synchronized to a system clock (allowing a fully synchronous system), or allocating the spectral components of the switching harmonics to insensitive frequency bands. Applying an external TTL clock of 800kHz to 2MHz to SYNC synchronizes the switching frequency of the MAX9700. The period of the SYNC clock can be randomized, enabling the MAX9700 to be synchronized to another MAX9700 operating in SSM mode.

### Filterless Modulation/Common-Mode Idle

The MAX9700 uses Maxim's modulation scheme that eliminates the LC filter required by traditional class D amplifiers, improving efficiency, reducing component count, and conserving board space and system cost. Conventional class D amplifiers

# 1.2W, Low-EMI, Filterless, Class D Audio Amplifier

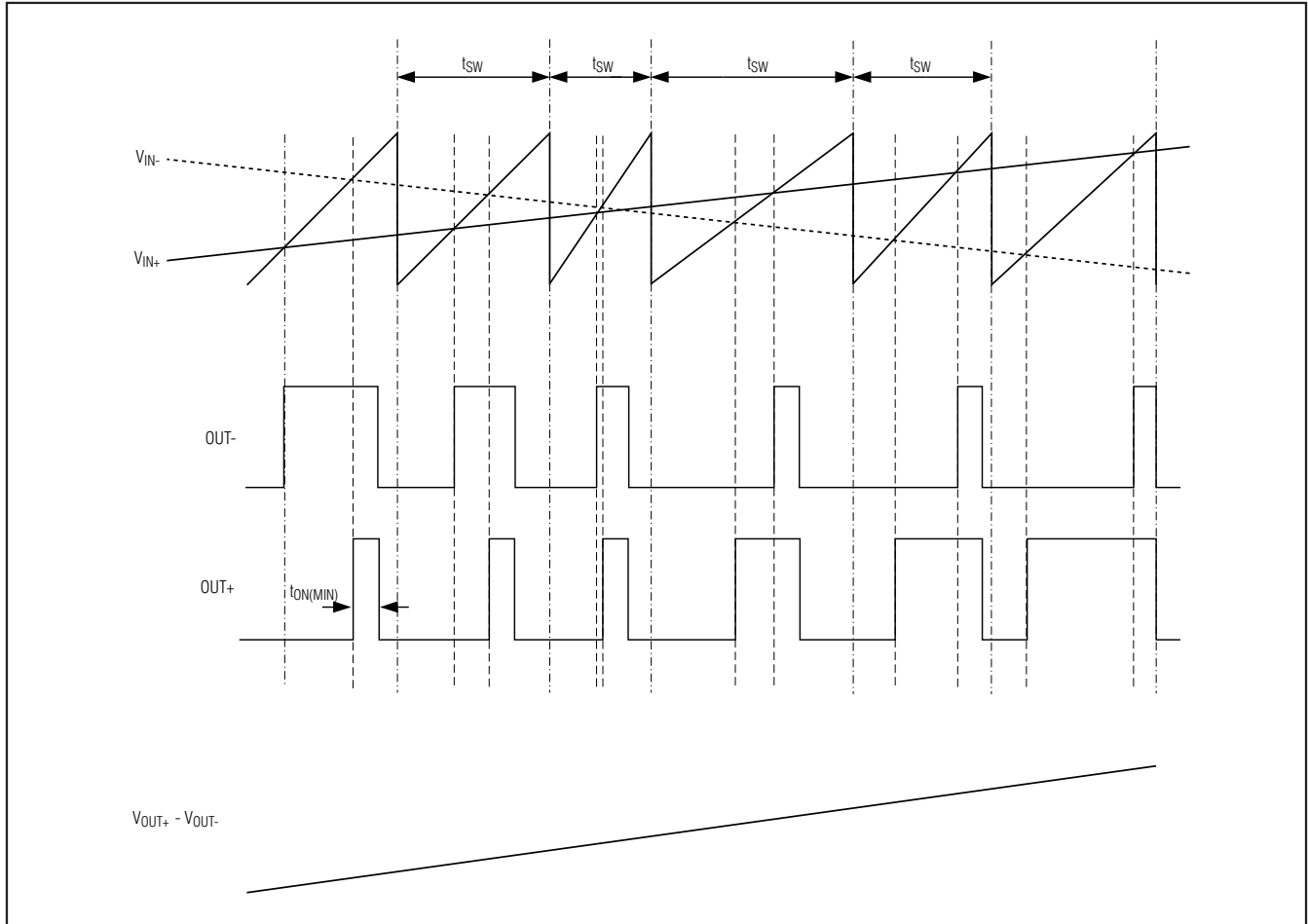

Figure 2. MAX9700 Output with an Input Signal Applied (SSM Mode)

output a 50% duty cycle square wave when no signal is present. With no filter, the square wave appears across the load as a DC voltage, resulting in finite load current, increasing power consumption. When no signal is present at the input of the MAX9700, the outputs switch as shown in Figure 4. Because the MAX9700 drives the speaker differentially, the two outputs cancel each other, resulting in no net Idle Mode™ voltage across the speaker, minimizing power consumption.

### Efficiency

Efficiency of a class D amplifier is attributed to the region of operation of the output stage transistors. In a

class D amplifier, the output transistors act as current-steering switches and consume negligible additional power. Any power loss associated with the class D output stage is mostly due to the  $I \times R$  loss of the MOSFET on-resistance, and quiescent current overhead.

The theoretical best efficiency of a linear amplifier is 78%; however, that efficiency is only exhibited at peak output powers. Under normal operating levels (typical music reproduction levels), efficiency falls below 30%, whereas the MAX9700 still exhibits >90% efficiencies under the same conditions (Figure 5).

Idle Mode is a trademark of Maxim Integrated Products.

# 1.2W, Low-EMI, Filterless, Class D Audio Amplifier

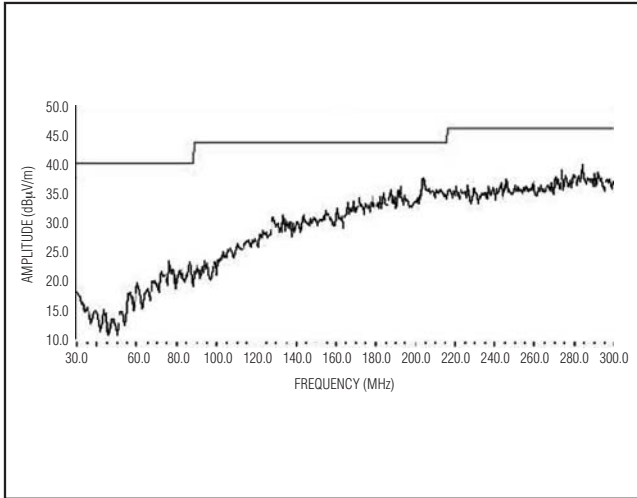

Figure 3. MAX9700 EMI Spectrum

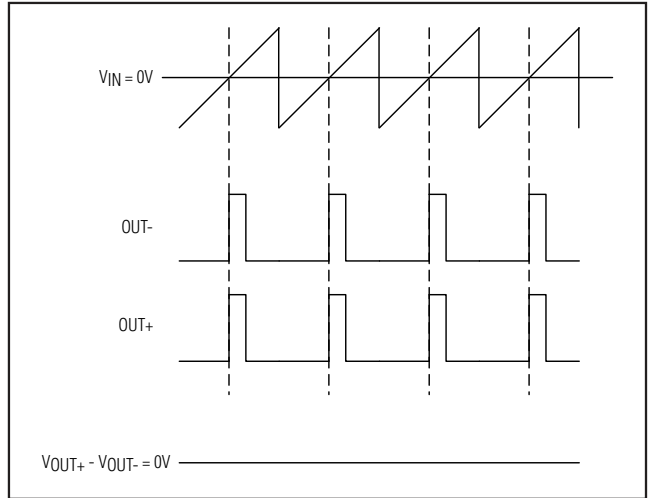

Figure 4. MAX9700 Outputs with No Input Signal

### Shutdown

The MAX9700 has a shutdown mode that reduces power consumption and extends battery life. Driving SHDN low places the MAX9700 in a low-power (0.1µA) shutdown mode. Connect SHDN to V<sub>DD</sub> for normal operation.

### Click-and-Pop Suppression

The MAX9700 features comprehensive click-and-pop suppression that eliminates audible transients on start-up and shutdown. While in shutdown, the H-bridge is in a high-impedance state. During startup or power-up, the input amplifiers are muted and an internal loop sets the modulator bias voltages to the correct levels, preventing clicks and pops when the H-bridge is subsequently enabled. For 35ms following startup, a soft-start function gradually unmutes the input amplifiers.

## Applications Information

### Filterless Operation

Traditional class D amplifiers require an output filter to recover the audio signal from the amplifier's output. The filters add cost, increase the solution size of the amplifier, and can decrease efficiency. The traditional PWM scheme uses large differential output swings (2 x V<sub>DD</sub> peak-to-peak) and causes large ripple currents. Any parasitic resistance in the filter components results in a loss of power, lowering the efficiency.

The MAX9700 does not require an output filter. The device relies on the inherent inductance of the speaker coil and the natural filtering of both the speaker and the human ear to recover the audio component of the square-wave output. Eliminating the output filter results in a smaller, less costly, more efficient solution.

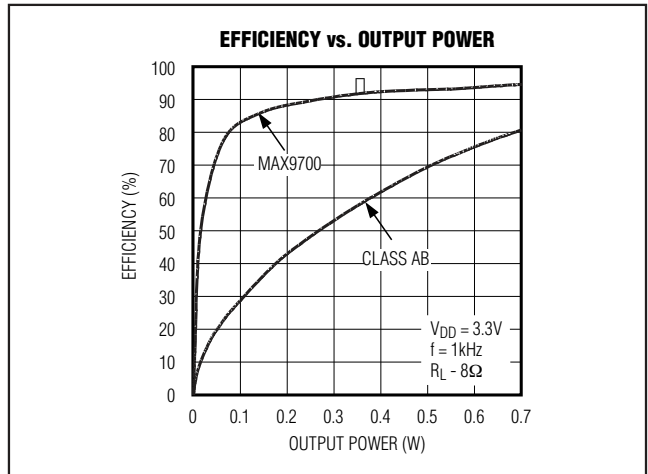

Figure 5. MAX9700 Efficiency vs. Class AB Efficiency

Because the frequency of the MAX9700 output is well beyond the bandwidth of most speakers, voice coil movement due to the square-wave frequency is very small. Although this movement is small, a speaker not designed to handle the additional power can be damaged. For optimum results, use a speaker with a series inductance >10µH. Typical 8Ω speakers exhibit series inductances in the 20µH to 100µH range.

### Power-Conversion Efficiency

Unlike a class AB amplifier, the output offset voltage of a class D amplifier does not noticeably increase quiescent current draw when a load is applied. This is due to

## 1.2W, Low-EMI, Filterless, Class D Audio Amplifier

the power conversion of the class D amplifier. For example, an 8mV DC offset across an 8Ω load results in 1mA extra current consumption in a class AB device. In the class D case, an 8mV offset into 8Ω equates to an additional power drain of 8μW. Due to the high efficiency of the class D amplifier, this represents an additional quiescent-current draw of 8μW/(V<sub>DD</sub>/100η), which is on the order of a few microamps.

### Input Amplifier Differential Input

The MAX9700 features a differential input structure, making it compatible with many CODECs, and offering improved noise immunity over a single-ended input amplifier. In devices such as cellular phones, high-frequency signals from the RF transmitter can be picked up by the amplifier's input traces. The signals appear at the amplifier's inputs as common-mode noise. A differential input amplifier amplifies the difference of the two inputs; any signal common to both inputs is canceled.

### Single-Ended Input

The MAX9700 can be configured as a single-ended input amplifier by capacitively coupling either input to GND and driving the other input (Figure 6).

### DC-Coupled Input

The input amplifier can accept DC-coupled inputs that are biased within the amplifier's common-mode range (see the *Typical Operating Characteristics*). DC coupling eliminates the input-coupling capacitors, reducing component count to potentially one external component (see the *System Diagram*). However, the low-frequency rejection of the capacitors is lost, allowing low-frequency signals to feedthrough to the load.

### Component Selection

#### Input Filter

An input capacitor, C<sub>IN</sub>, in conjunction with the input impedance of the MAX9700 forms a highpass filter that removes the DC bias from an incoming signal. The AC-coupling capacitor allows the amplifier to bias the signal to an optimum DC level. Assuming zero source impedance, the -3dB point of the highpass filter is given by:

$$f_{-3dB} = \frac{1}{2\pi R_{IN} C_{IN}}$$

Choose C<sub>IN</sub> so f<sub>-3dB</sub> is well below the lowest frequency of interest. Setting f<sub>-3dB</sub> too high affects the low-frequency response of the amplifier. Use capacitors

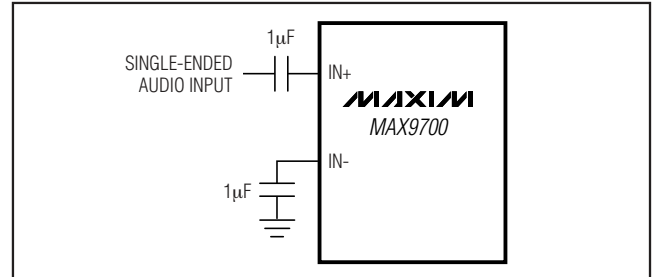

Figure 6. Single-Ended Input

whose dielectrics have low-voltage coefficients, such as tantalum or aluminum electrolytic. Capacitors with high-voltage coefficients, such as ceramics, may result in increased distortion at low frequencies.

Other considerations when designing the input filter include the constraints of the overall system and the actual frequency band of interest. Although high-fidelity audio calls for a flat gain response between 20Hz and 20kHz, portable voice-reproduction devices such as cellular phones and two-way radios need only concentrate on the frequency range of the spoken human voice (typically 300Hz to 3.5kHz). In addition, speakers used in portable devices typically have a poor response below 150Hz. Taking these two factors into consideration, the input filter may not need to be designed for a 20Hz to 20kHz response, saving both board space and cost due to the use of smaller capacitors.

### Output Filter

The MAX9700 does not require an output filter. The device passes FCC emissions standards with 100mm of unshielded speaker cables. However, output filtering can be used if a design is failing radiated emissions due to board layout or cable length, or the circuit is near EMI-sensitive devices. Use an LC filter when radiated emissions are a concern, or when long leads are used to connect the amplifier to the speaker.

### Supply Bypassing/Layout

Proper power-supply bypassing ensures low-distortion operation. For optimum performance, bypass V<sub>DD</sub> to GND and PV<sub>DD</sub> to PGND with separate 0.1μF capacitors as close to each pin as possible. A low-impedance, high-current power-supply connection to PV<sub>DD</sub> is assumed. Additional bulk capacitance should be added as required depending on the application and power-supply characteristics. GND and PGND should be star connected to system ground. Refer to the MAX9700 evaluation kit for layout guidance.

# 1.2W, Low-EMI, Filterless, Class D Audio Amplifier

## Stereo Configuration

Two MAX9700s can be configured as a stereo amplifier (Figure 7). Device U1 is the master amplifier; its unfiltered output drives the SYNC input of the slave device (U2), synchronizing the switching frequencies of the two devices. Synchronizing two MAX9700s ensures that no beat frequencies occur within the audio spectrum. This configuration works when the master device is in either FFM or SSM mode. There is excellent THD+N performance and minimal crosstalk between devices due to the SYNC connection (Figures 8 and 9). U2 locks onto only the frequency present at SYNC, not the pulse width. The internal feedback loop of device U2 ensures that the audio component of U1's output is rejected.

## Designing with Volume Control

The MAX9700 can easily be driven by single-ended sources (Figure 6), but extra care is needed if the source impedance "seen" by each differential input is unbalanced, such as the case in Figure 10a, where the MAX9700 is used with an audio taper potentiometer acting as a volume control. Functionally, this configuration works well, but can suffer from click-pop transients at power-up (or coming out of SHDN) depending on the volume-control setting. As shown, the click-pop performance is fine for either max or min volume, but worsens at other settings.

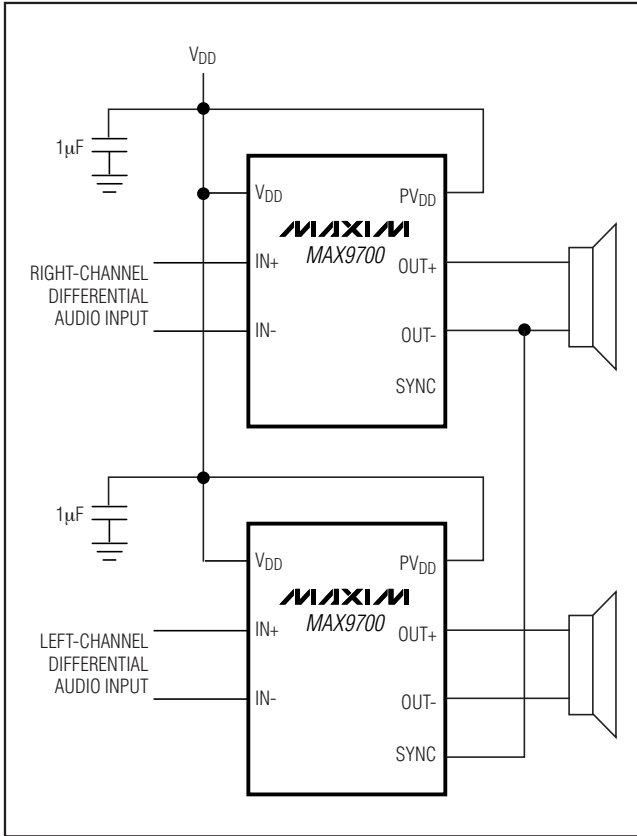

Figure 7. Master-Slave Stereo Configuration

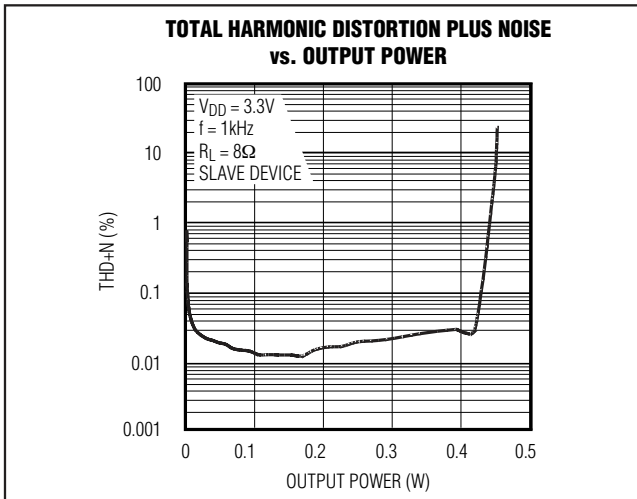

Figure 8. Master-Slave THD+N

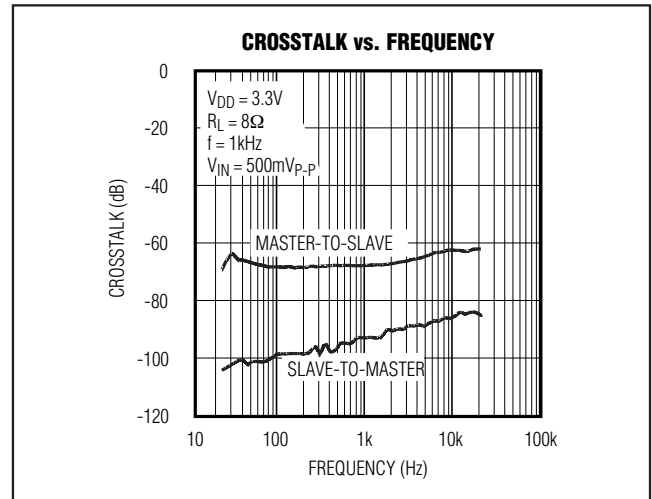

Figure 9. Master-Slave Crosstalk

# 1.2W, Low-EMI, Filterless, Class D Audio Amplifier

One solution is the configuration shown in Figure 10b. The potentiometer is connected between the differential inputs, and these “see” identical RC paths when the device powers up. The variable resistive element appears between the two inputs, meaning the setting affects both inputs the same way. The potentiometer is audio taper, as in Figure 10a. This significantly improves transient performance on power-up or release from SHDN. A similar approach can be applied when the MAX9700 is driven differentially and a volume control is required.

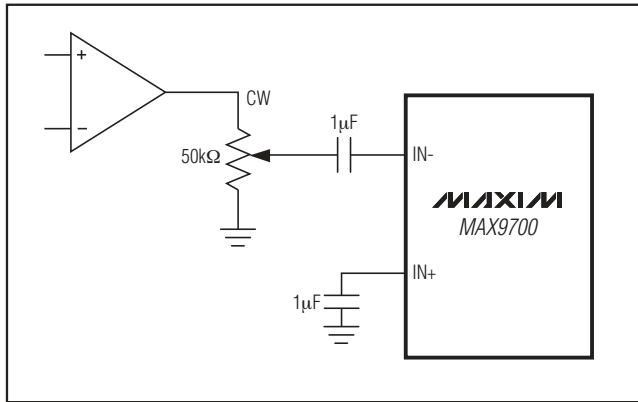

Figure 10a. Single-Ended Drive of MAX9700 Plus Volume

## UCSP Applications Information

For the latest application details on UCSP construction, dimensions, tape carrier information, PC board techniques, bump-pad layout, and recommended reflow temperature profile, as well as the latest information on reliability testing results, refer to the Application Note: *UCSP—A Wafer-Level Chip-Scale Package* available on Maxim’s website at [www.maxim-ic.com/ucsp](http://www.maxim-ic.com/ucsp).

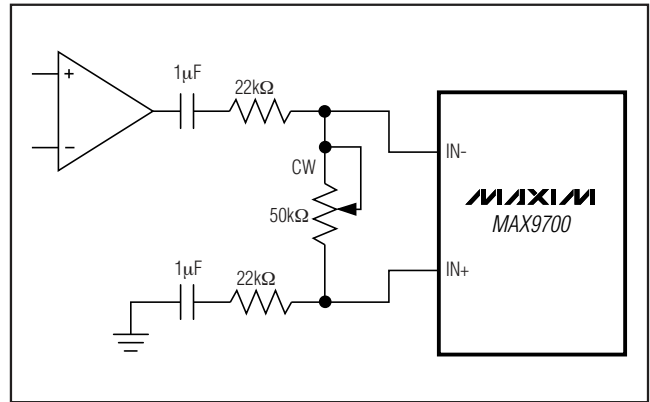

Figure 10b. Improved Single-Ended Drive of MAX9700 Plus Volume

## Ordering Information (continued)

PART	TEMP RANGE	PIN-PACKAGE	TOP MARK
MAX9700CETB	-40°C to +85°C	10 TDFN-EP*	ACN
MAX9700CEUB	-40°C to +85°C	10 μMAX	—
MAX9700CEBC-T	-40°C to +85°C	12 UCSP	—
MAX9700DETb	-40°C to +85°C	10 TDFN-EP*	ACO
MAX9700DEUB	-40°C to +85°C	10 μMAX	—
MAX9700DEBC-T	-40°C to +85°C	12 UCSP	—

\*EP = Exposed pad.

## Selector Guide

PART	PIN-PACKAGE	GAIN (dB)
MAX9700AETB	10 TDFN-EP*	6
MAX9700AEUB	10 μMAX	6
MAX9700AEBC-T	12 UCSP	6
MAX9700BETB	10 TDFN-EP*	12
MAX9700BEUB	10 μMAX	12
MAX9700BEBC-T	12 UCSP	12
MAX9700CETB	10 TDFN-EP*	15.6
MAX9700CEUB	10 μMAX	15.6
MAX9700CEBC-T	12 UCSP	15.6
MAX9700DETb	10 TDFN-EP*	20
MAX9700DEUB	10 μMAX	20
MAX9700DEBC-T	12 UCSP	20

\*EP = Exposed pad.

# 1.2W, Low-EMI, Filterless, Class D Audio Amplifier

## System Diagram

MAX9700

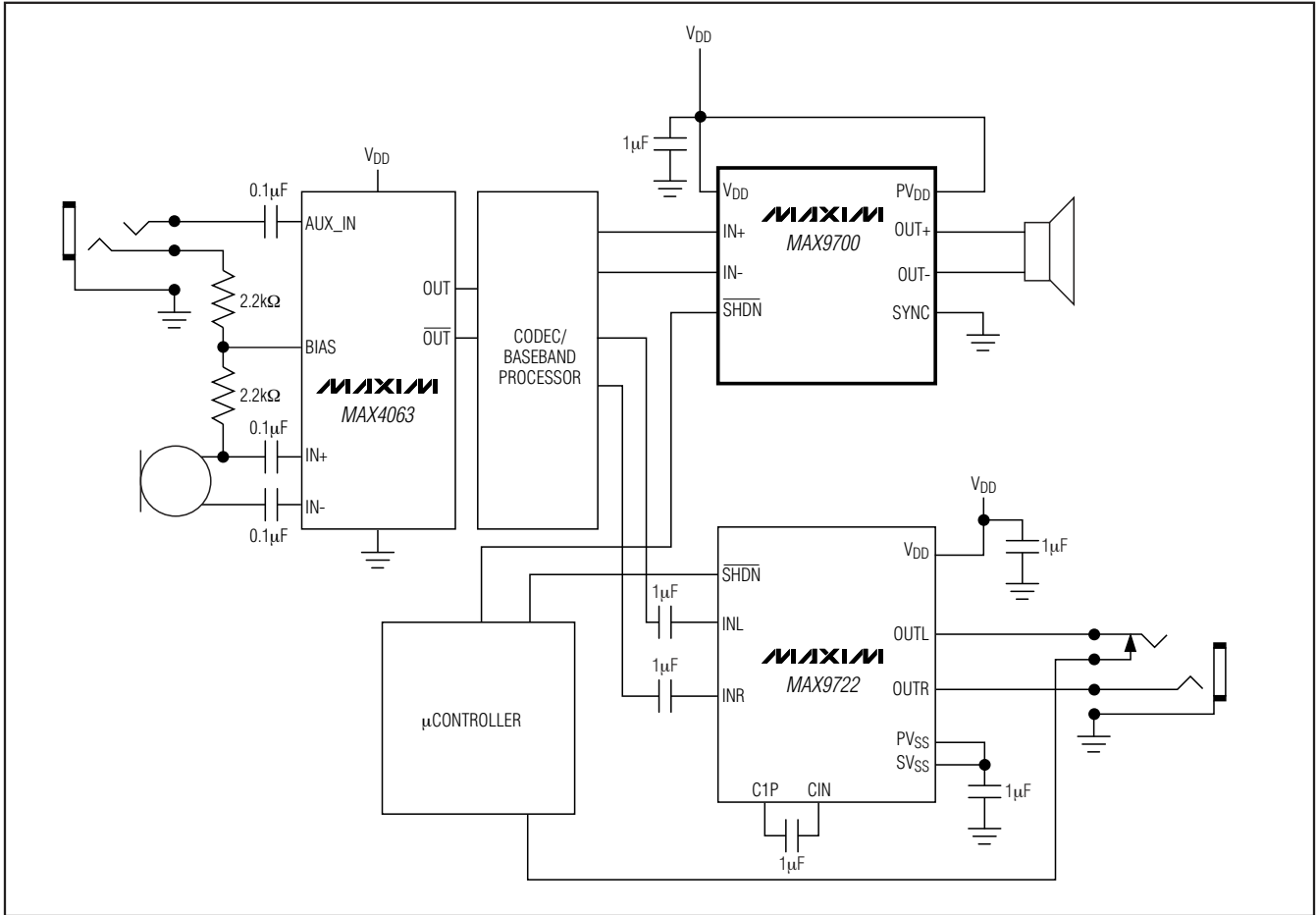

## Pin Configurations (continued)

## Chip Information

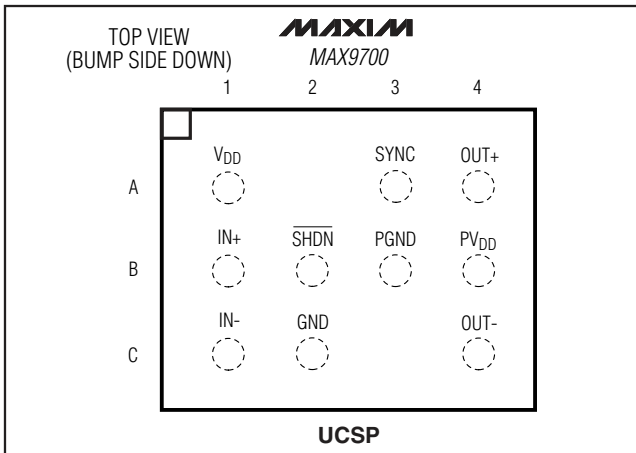

TRANSISTOR COUNT: 3595  
PROCESS: BiCMOS

# 1.2W, Low-EMI, Filterless, Class D Audio Amplifier

## Package Information

For the latest package outline information and land patterns, go to [www.maxim-ic.com/packages](http://www.maxim-ic.com/packages).

PACKAGE TYPE	PACKAGE CODE	DOCUMENT NO.
12 UCSP	B12-11	<a href="#">21-0104</a>
10 TDFN-EP	T1033-1	<a href="#">21-0137</a>
10 $\mu$ MAX	U10-2	<a href="#">21-0061</a>

**TOP VIEW**

COMMON DIMENSIONS	
A	0.62±0.05-0.08
A1	0.29±0.02
A2	0.33 REF.
b	0.35±0.03
D1	1.00 BASIC
E1	1.50 BASIC
e	0.50 BASIC
SD	0.00 BASIC
SE	0.25 BASIC

PKG. CODE	VARIABLE DIMENSIONS		DEPOPULATED SOLDER BALLS
	D	E	
B12-1	1.54±0.05	2.02±0.05	NONE
B12-2	1.54±0.05	2.02±0.05	B3
B12-3	1.54±0.05	2.12±0.05	NONE
B12-4	1.54±0.05	2.02±0.05	B2, B3
B12-5	1.64±0.05	2.12±0.05	B2
B12-6	1.64±0.05	2.12±0.05	B3
B12-7	1.54±0.05	2.02±0.05	B1, B3
B12-8	1.54±0.05	2.02±0.05	B2
B12-9	1.54±0.05	2.12±0.05	B2, B3
B12-10	1.54±0.05	2.02±0.05	B1, B2, B3, B4
B12-11	1.54±0.05	2.02±0.05	A2, C3

**NOTES:**

- ALL DIMENSIONS ARE IN MILLIMETERS.
- PRODUCT MARKING: NUMBER OF CHARACTERS AND LINES VARY PER PRODUCT.

**BOTTOM VIEW**

**SIDE VIEW**

12L, UCSP 4x3.EPS

<b>DALLAS SEMICONDUCTOR</b>		
<b>MAXIM</b>		
<small>PROPRIETARY INFORMATION</small>		
TITLE: PACKAGE OUTLINE, 4x3 UCSP		
APPROVAL	DOCUMENT CONTROL NO. 21-0104	REV. F 1/1



# 1.2W, Low-EMI, Filterless, Class D Audio Amplifier

## Package Information (continued)

For the latest package outline information and land patterns, go to [www.maxim-ic.com/packages](http://www.maxim-ic.com/packages).

**MAX9700**

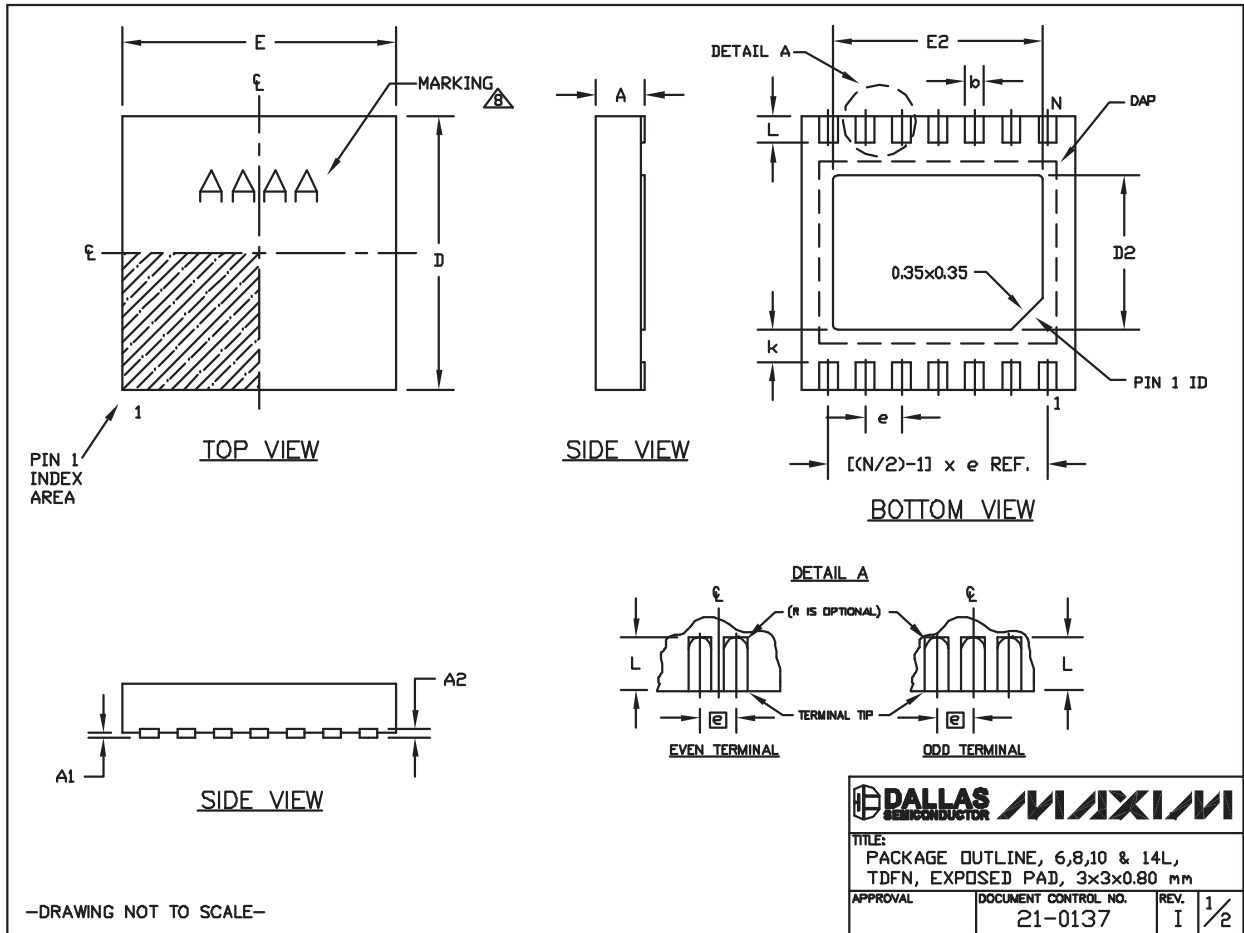

# 1.2W, Low-EMI, Filterless, Class D Audio Amplifier

## Package Information (continued)

For the latest package outline information and land patterns, go to [www.maxim-ic.com/packages](http://www.maxim-ic.com/packages).

COMMON DIMENSIONS		
SYMBOL	MIN.	MAX.
A	0.70	0.80
D	2.90	3.10
E	2.90	3.10
A1	0.00	0.05
L	0.20	0.40
k	0.25 MIN.	
A2	0.20 REF.	

PACKAGE VARIATIONS							
PKG. CODE	N	D2	E2	e	JEDEC SPEC	b	[(N/2)-1] x e
T633-2	6	1.50-0.10	2.30-0.10	0.95 BSC	MO229 / WEEA	0.40-0.05	1.90 REF
T833-2	8	1.50-0.10	2.30-0.10	0.65 BSC	MO229 / WEEC	0.30-0.05	1.95 REF
T833-3	8	1.50-0.10	2.30-0.10	0.65 BSC	MO229 / WEEC	0.30-0.05	1.95 REF
T1033-1	10	1.50-0.10	2.30-0.10	0.50 BSC	MO229 / WEED-3	0.25-0.05	2.00 REF
T1033-2	10	1.50-0.10	2.30-0.10	0.50 BSC	MO229 / WEED-3	0.25-0.05	2.00 REF
T1433-1	14	1.70-0.10	2.30-0.10	0.40 BSC	----	0.20-0.05	2.40 REF
T1433-2	14	1.70-0.10	2.30-0.10	0.40 BSC	----	0.20-0.05	2.40 REF

**NOTES:**

1. ALL DIMENSIONS ARE IN mm. ANGLES IN DEGREES.
2. COPLANARITY SHALL NOT EXCEED 0.08 mm.
3. WARPAGE SHALL NOT EXCEED 0.10 mm.
4. PACKAGE LENGTH/PACKAGE WIDTH ARE CONSIDERED AS SPECIAL CHARACTERISTIC(S).
5. DRAWING CONFORMS TO JEDEC MO229, EXCEPT DIMENSIONS "D2" AND "E2", AND T1433-1 & T1433-2.
6. "N" IS THE TOTAL NUMBER OF LEADS.
7. NUMBER OF LEADS SHOWN ARE FOR REFERENCE ONLY.
8. MARKING IS FOR PACKAGE ORIENTATION REFERENCE ONLY.

-DRAWING NOT TO SCALE-

			
TITLE: PACKAGE OUTLINE, 6,8,10 & 14L, TDFN, EXPOSED PAD, 3x3x0.80 mm			
APPROVAL	DOCUMENT CONTROL NO.	REV.	
	21-0137	I	2/2

# 1.2W, Low-EMI, Filterless, Class D Audio Amplifier

## Package Information (continued)

For the latest package outline information and land patterns, go to [www.maxim-ic.com/packages](http://www.maxim-ic.com/packages).

MAX9700

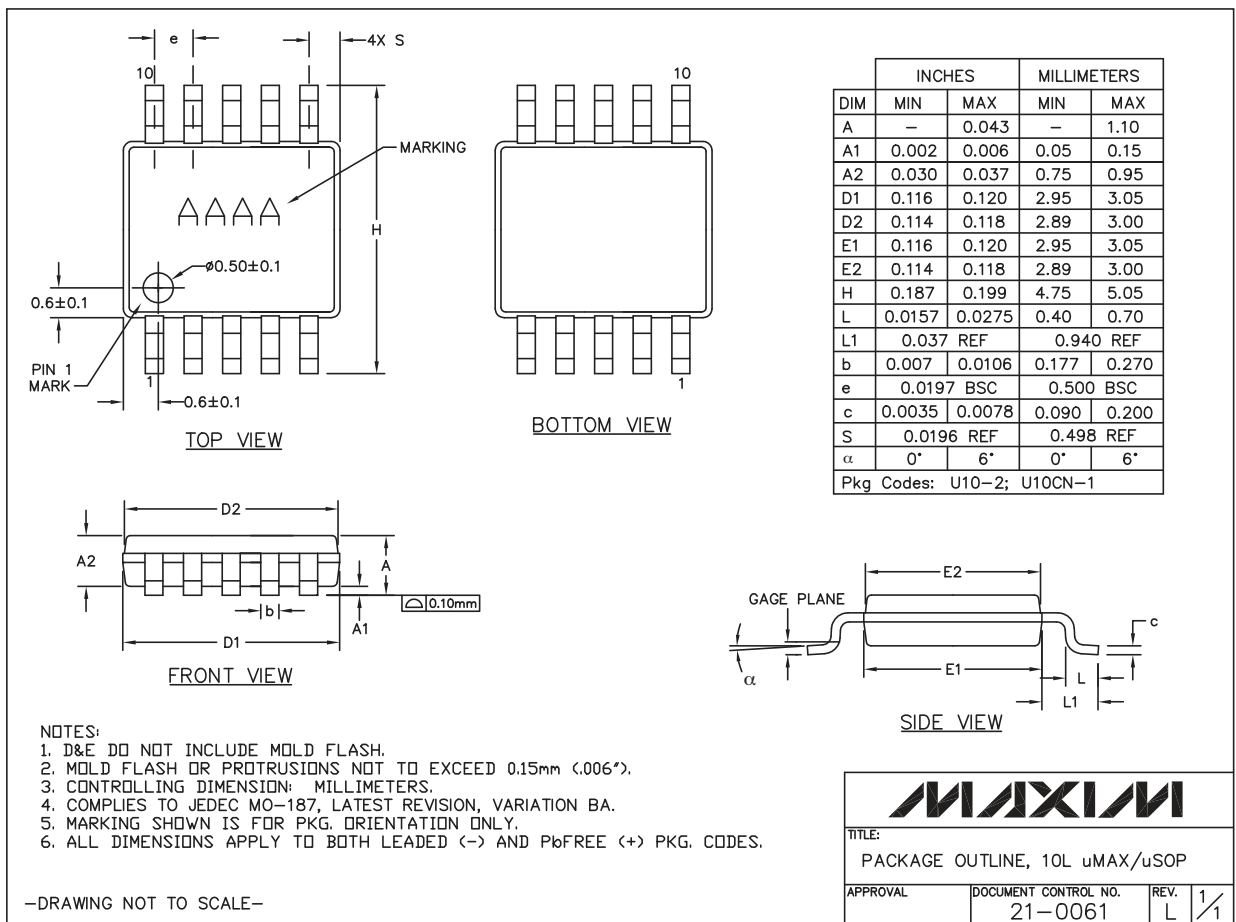

10LUMAXEFS

# 1.2W, Low-EMI, Filterless, Class D Audio Amplifier

## Revision History

REVISION NUMBER	REVISION DATE	DESCRIPTION	PAGES CHANGED
0	10/03	Initial release	—
1	6/04	Changes made to TOCs and specs	3-8, 14, 15
2	10/08	Addition of EP information to pin description table	1, 2, 3, 8, 14

Maxim cannot assume responsibility for use of any circuitry other than circuitry entirely embodied in a Maxim product. No circuit patent licenses are implied. Maxim reserves the right to change the circuitry and specifications without notice at any time.

20 \_\_\_\_\_ **Maxim Integrated Products, 120 San Gabriel Drive, Sunnyvale, CA 94086 408-737-7600**