



SPECIFICATION SHEET

SPECIFICATION SHEET NO.	Q0501-CG10M00000S001
DATE	May 01, 2023
REVISION	A0
DESCRIPTION	SMD Ceramic Resonator, 3731 Type, L3.7*W3.1*H1.2mm, Without Built-in Capacitance, 2 pads, CRAV Series 10.000MHz, Frequency Accuracy +/-0.5%, Operating Temp. Range -25°C ~+85°C, Reflow Profile Condition 260 °C Max. RoHS/RoHS III compliant, Tape/Reel
CUSTOMER	
CUSTOMER PART NUMBER	
CROSS REF. PART NUMBER	
ORIGINAL PART NUMBER	TGS CRAV 10.0MT TLF
PART CODE	CG10M00000S001

VENDOR APPROVE			
Issued/Checked/Approved			
DATE: May 01, 2023			

CUSTOMER APPROVE	
DATE:	

5/1/2023

SMD CERAMIC RESONATOR CRAV SERIES

MAIN FEATURE

- SMD Ceramic Resonator, L3.7*W3.1*H1.2mm, 2 pads
- Low cost & Without Built-in Capacitance
- Reflow Profile Condition 260 °C Max.
- Wide Frequency Range
- Cross more competitors part
- RoHS III compliant



APPLICATION

- Bluetooth, wireless communication set
- Communication Electronics

PART CODE GUIDE

RFQ
Request For Quotation

CG	10M00000	S	001
1	2	3	4

- 1) CG: Part family Code for SMD Ceramic Resonator, L3.7*W3.1*H1.2mm, 2 pads, CRAV series
- 2) 10M00000: Frequency range code for 10.00000MHz
- 3) S: SMD type, Package Tape/Reel, 1000pcs/Reel
- 4) 001: Specification code for original part No.: **TGS CRAV 10.0MT TLF**

SMD CERAMIC RESONATOR CRAV SERIES

DIMENSION (Unit: mm)

Image for reference

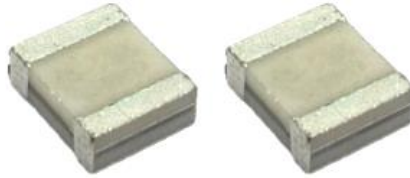

CRAV

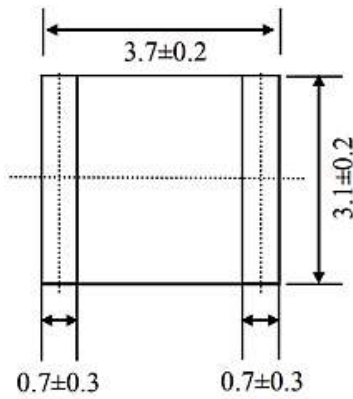

Marking

Line 1: Freq. Range+ QC Code (A~Z)

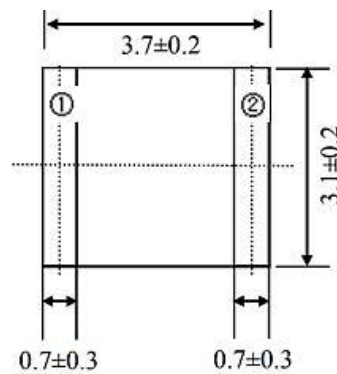

Connection

#1 In/Output #2 Output/Input

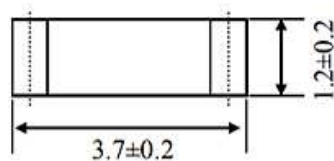

SMD CERAMIC RESONATOR CRAV SERIES
ELECTRICAL PARAMETERS

Parameter	Part No. Symbol	Units	Value			Condition
			Min.	Typical	Max.	
Original Manufacturer	TGS	TGS Crystals				
Holder Type	CRAV	SMD Ceramic Resonator, L3.7*W3.1*H1.2mm, 2 pads				
Frequency Range	10.0	MHz	10.0			
Withstanding Voltage		V	50			@DC, 1 min
Insulation Resistance		MΩ	500			@AV, 1 min.
Operation Temperature		°C	-25		+85	
Storage Temperature		°C	-55		+85	
Rating Voltage		V	6.0			DC
			15			p-p
Frequency Accuracy		%	0.5			
Resonant Impedance		Ω			40	
Temperature Coefficient of Oscillation Frequency		%			+/-0.3	Oscillation Frequency drift, -25°C ~ +85°C)
Oscillation Frequency Aging Rate (10 years)		%			+/-0.3	From initial value
IC application			1/6TC4069UBP			
Design Mode	MT					
Built-in Capacitance		pF	N/A			
Other	Package	T	Tape/Reel			
	RoHS Status	LF	RoHS III compliant			
	Add Value		N/A			
	Internal Control Code *		N/A			

Note: 1) Original Part Number: **TGS CRAV 10.0MT TLF**

2) * Internal Control Code- 2 letter or digits; Blank: N/A

SMD CERAMIC RESONATOR CRAV SERIES
RELIABILITY

Test Items	Test Method And Conditions	Performance Requirements
Humidity	Keep the resonator at 40°C±2°C and 90%-95% RH for 96h. Then Release the resonator into the room Condition for 1h prior to the Measurement.	It shall fulfill the specifications in Table 1.
High Temperature Exposure	Subject the resonator to -85°C±2°C for 96h, then release the resonator into the room conditions for 1h prior to the measurement.	It shall fulfill the specifications in Table 1.
Low Temperature Exposure	Subject the resonator to -55°C±2°C for 96h, then release the resonator into the room conditions for 1h prior to the measurement.	It shall fulfill the specifications in Table 1.
Temperature Cycling	After temperature cycling of blow table was performed 5 times, resonator shall be measured after being placed in natural conditions for 1h. Time: 30 min.@ -25 +/--3°C ; Time: 30 min. @85 +/--3°C	It shall fulfill the specifications in Table 1.
Vibration	Subject the resonator to vibration for 2h each in x, y and z axis With the amplitude of 1.5mm, the frequency shall be varied uniformly between the limits of 10 Hz—55Hz.	It shall fulfill the specifications in Table 1.
Mechanical Shock	Drop the resonator randomly onto a wooden floor from the height of 100cm 3 times.	It shall fulfill the specifications in Table 1.
Soldering Test	Passed through the re-flow oven under the following condition and left at room temperature for 1h before measurement	It shall fulfill the specifications in Table 1.
Solder Ability	Dipped in 245°C±5°C solder bath for 3s±0.5 s with rosin flux (25wt% ethanol solution.)	The terminals shall be at least 95% covered by solder.
Board Bending	Mount a glass-epoxy board (Width=40mm,thickness=1.6mm),then bend it to 1mm displacement and keep it for 5s. (See the following figure 1)	Mechanical damage such as breaks shall not occur.

Table 1

Item	Specification after test
Oscillation Frequency Change $\Delta F_{osc}/F_{osc}$ (%) max	±0.3
Resonant Impedance (Ω) max	40
The limits in the above table are referenced to the initial measurements.	

SMD CERAMIC RESONATOR CRAV SERIES

TEST CIRCUIT (For Reference Only)

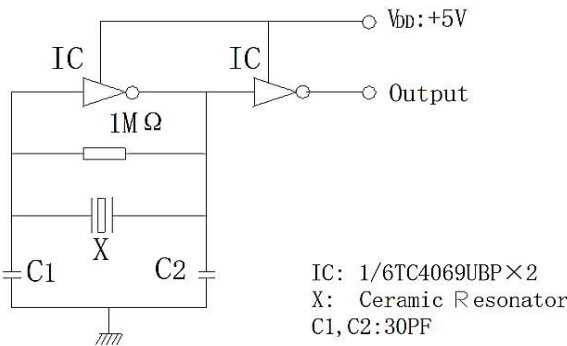

Note:

Parts shall be tested under the condition
 (Temp.: 20±15°C, Humidity 65±20% R.H.) unless the
 standard condition (Temp.: 25±3 °C, Humidity :65±10%
 R.H.) is regulated to measure.

SUGGESTED REFLOW PROFILE (For Reference Only)

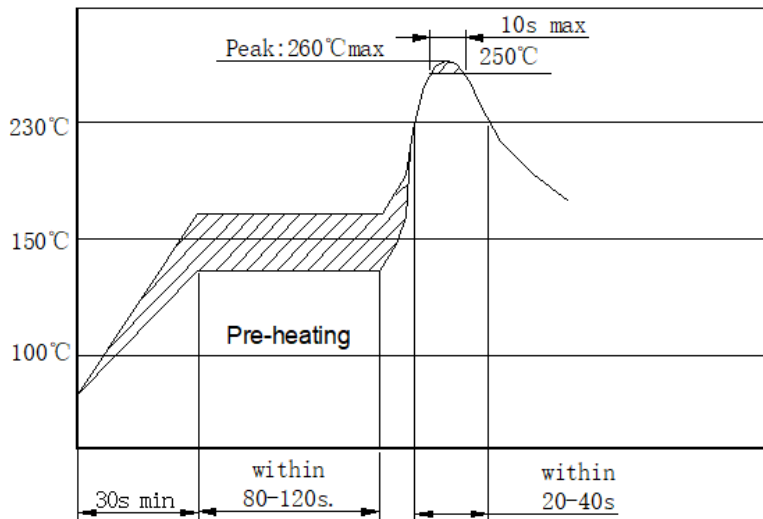

BOARD BENDING TEST- FIGURE 1

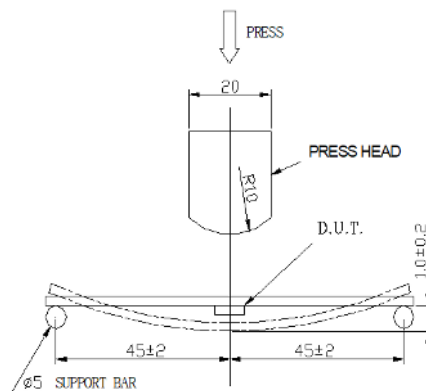

SMD CERAMIC RESONATOR CRAV SERIES

TAPE/REEL (Unit: mm)

All Devices are packed in accordance with EIA standard RS-481-2 and specifications., 1000pcs/Reel



Symbol	Dimension
ϕA	180 \pm 3.0
ϕB	60.0 Min.
W	12.4 Min.
T	19.4 Max.

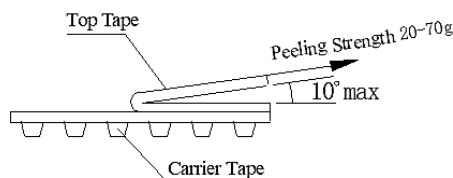

DISCLAIMER

NextGen Components, Inc. reserves the right to make changes to the product(s) and or information contained herein without notice. No liability is assumed as a result of their use or application. No rights under any patent accompany the sale of any such product(s) or information