

## Component Carriers and Housings

### Weidmüller DK 4 and DKT 4 terminals

are suitable for the installation of electronic components with a maximum diameter or width of 4.5 mm. Four independent clamping yoke screw connections are available. A snap-on frame expands the installation space in the DK4 by 6 mm respectively. Depending on type, these modular terminals are suitable for mounting on TS 32, TS 35 x 7.5 or TS 35 x 15 mounting rails according to European standards EN 50 035 and EN 50 022.

### Weidmüller WDK 2.5 terminals

are suitable for the installation of electrical components with a maximum width of 4 mm. As many as four independent clamping yoke screw connections or 4 6.3 x 0.8 tab connections are available. These terminals are suitable for mounting on TS 35 x 7.5 or TS 35 x 15 mounting rails.

### Weidmüller EG 1 housings

offer 4 screw connections and, as accessories, up to 4 0.8 x 4.8 mm solder/tab connections on a width of 18 mm. The screw clamp busbar ends with a solder ring inside the housing. Two end plates seal the module. Depending on type, the modules are mounted on TS 32, TS 35 x 7.5 or TS 35 x 15 mounting rails.

### Weidmüller EG 2 housings

The external shape of these housings corresponds to Type EG 1. Four screw connections or up to 8 0.8 x 6.6 mm/0.8 x 2.8 mm tab connectors are connected with a printed circuit board in the housing. They can be mounted on TS 32, TS 35 x 7.5 or TS 35 x 15 mounting rails.

### Weidmüller EG 3 housings

provides 6 screw connections or 12 0.8 x 6.3 mm/0.8 x 2.8 mm tab connections on a width of 22.5 mm. As an accessory, Weidmüller offers a shaped printed circuit board with a 2.54 mm hole grid or fully copper-coated. The engagable combination foot allows the terminal to be mounted on TS 32, TS 35 x 7.5 or TS 35 x 15 mounting rails. The MPL mounting plate is used to mount the housing directly (without mounting rail). Due to the sliding foot construction, the EG 3 can be turned through 180° in all types of assembly (e.g. exchanging input and output).

### Weidmüller EG 4 housing

as type EG 3, offers the same width of 22.5 mm. However, the greater installation depth (75 mm) and height (109 mm) allow the installation of more complex circuit configurations. The built-in installation can be connected via 6 screw connections. The snap-on combination foot allows the terminal to be mounted on TS 32, TS 35 x 7.5 or TS 35 x 15 mounting rails. Due to the sliding foot construction, the EG 4 can be slid forwards or backwards on the locking foot, and can be turned through 180° (e.g. exchanging of input and output).

### Weidmüller EG 5 housings

correspond to type EG 4. The EG 5 has 12 screw connections, which can be wired with solder lugs inside the housing. The snap-on combination foot allows the terminal to be mounted on TS 32, TS 35 x 7.5 or TS 35 x 15 mounting rails. Due to the sliding foot construction, the EG 4 can be slid 6 mm forwards or backwards on the engaging foot and can be turned through 180° (e.g. exchanging input and output).

### Weidmüller EG 6 housings

have a bus-suitable contact carrier. The bus connection is created by directly mounting several housings in a row. 32 connections are available on both sides of the housing as crimp connector block contacts. The housing accepts printed circuit boards with dimensions of 100 x 120 mm. The printed circuit board is adapted with a VG 64 DIN strip. The front panel is screwed onto the circuit board similar to the 19" technology. The locking foot allows easy mounting onto the TS 35 mounting rail.

### Weidmüller SEG/U housing

enable the plug-in module assembly of a 70 x 52 x 1 mm printed circuit board. The circuit board is attached to the accessory cover plate via snap-in hooks. The housing contains a 13-pole socket block for installation of the module; 6 screw connections are available for connection. The permissible power loss in the housing during continuous operation of terminals in rows amounts to 1.5W, depending on the surface temperature of the soldered components. The snap-on combination foot allows the housings to be mounted on TS 32, TS 35 x 7.5 or TS 35 x 15 mounting rails.

### Weidmüller housings type WAVEBOX

It is essential to provide fit-for-use housings for modern electronic components. Setting and control functions must be easily carried out and technical requirements with respect to heat dissipation and EMV properties should be supported.

An ideal design saves space and wiring costs in the switchgear cabinet.

In addition, ergonomics and design are becoming increasingly important for high-quality electronic products.

These are the criteria that led to the development of WAVEBOX. Simplified production methods (shaft soldering, SMD) ensure cost-savings for the customer.

The WAVEBOX is characterised by:

- Optimum width for any application (12.5 mm, 17.5 mm, 22.5 mm)
- Large component assembly surface; SMDs can be mounted on the solder side
- UL94 flammability class V2
- No tools required for assembly
- Plug-in printed circuit board
- Plug-in cross-connection via ZQV 2.5 N
- Hinged, transparent cover
- BLZ 5.08 screw/plug and socket connector
- BLFZ 5.08 optional tension clamp/plug and socket connector
- Marking option with WS tags
- Mounts onto TS 35

### Weidmüller individual parts for RS 70 locking socket

latch together to form units from 20 mm in width. Any desired intermediate parts or feet can be connected between two side pieces (locking feet) at intervals of 5 mm. In this way, a carrier module is constructed for PCB, on which various components can be soldered. The assembly snaps onto TS 32, TS 35 x 7.5 or TS 35 x 15 mounting rails.

### The Weidmüller RSX custom circuit module

is a largely prefabricated unit which accepts up to 5 components such as resistors, diodes, varistors or capacitors via soldering terminals. The components are connected via screw clamps or tab connections. This module is also suitable for mounting on TS 32, TS 35 x 7.5 or TS 35 x 15 mounting rails.

### Weidmüller locking socket profiles

The RS 45, RS 80 and RS 100 profiles are available as 2 m long strips. The extruded profiles can be easily cut to any length with a saw. In this way, a carrier module is constructed for a printed circuit board on which various components can be soldered. Locking feet can be slid into these profiles for mounting on TS 32, TS 35 x 7.5 or TS 35 x 15 mounting rails. The sliding foot construction of the RS 80 also allows the fixing foot be turned through 180°.

# Housings

## Terminals

### DK 4

### DKT 4

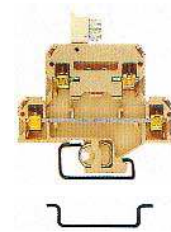
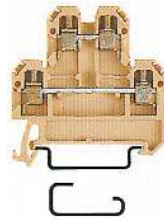

#### Dimensions

Terminal width (+fitting tolerance 0.2)	6 mm
Insulating stripping length	9 mm

Terminal width (+fitting tolerance 0.2)	6 mm
Insulating stripping length	9 mm

Terminal width (+fitting tolerance 0.2)	6 mm
Insulating stripping length	9 mm

#### Connection data

Screw connection, solid	0.5...4 mm <sup>2</sup>
Screw connection, stranded	0.5...4 mm <sup>2</sup>
Conductor cross-section	AWG 22...12
Tightening torque range	0.5-1.0 Nm
Torque phase with	1
DMS 2 electric screwdriver	

Screw connection, solid	0.5...4 mm <sup>2</sup>
Screw connection, stranded	0.5...4 mm <sup>2</sup>
Conductor cross-section	AWG 22...12
Tightening torque range	0.5-1.0 Nm
Torque phase with	1
DMS 2 electric screwdriver	

Screw connection, solid	0.5...4 mm <sup>2</sup>
Screw connection, stranded	0.5...4 mm <sup>2</sup>
Conductor cross-section	AWG 22...17
Tightening torque range	0.5 - 1.0 Nm
Torque phase with	1
DMS 2 electric screwdriver	

#### Rated data acc. to VDE

Rated cross-section	4 mm <sup>2</sup>
Rated voltage	380 V~
Rated current	10 A
Power loss	0.5 W

Rated cross-section	4 mm <sup>2</sup>
Rated voltage	380 V~
Rated current	10 A
Power loss	0.5 W

Rated cross-section	4 mm <sup>2</sup>
Rated voltage	380 V~
Rated current	10 A
Power loss	0.5 W

#### Connection diagram

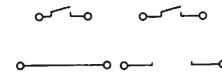
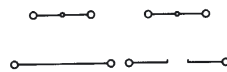

#### Ordering data

Terminal		Type	Cat. No.
for TS 32 ʎ	Type	DK 4 PA	
	Cat. No.	<b>1537960000</b>	<b>1115460000</b>
for TS 35 w	Type	DK 4/35 PA	
	Cat. No.	<b>8203490000</b>	<b>1115560000</b>

Terminal		Type	Cat. No.
for TS 32 ʎ	Type	DK 4 PA	
	Cat. No.	<b>1537960000</b>	<b>1115460000</b>
for TS 35 w	Type	DK 4/35 PA	
	Cat. No.	<b>8203490000</b>	<b>1115560000</b>

Terminal		Type	Cat. No.
for TS 32 ʎ	Type	DKT 4 PA	
	Cat. No.	<b>1686940000</b>	<b>1115660000</b>
for TS 35 w	Type	DKT 4 /35PA	
	Cat. No.	<b>0687460000</b>	<b>1115760000</b>

Matching contour frame		Type	Cat. No.
for TS 32 ʎ	Type	DK 4 RA	
	Cat. No.	<b>0690960000</b>	<b>0690960000</b>
for TS 35 w	Type	DK 4 RA/35	
	Cat. No.	<b>0691060000</b>	<b>0691060000</b>

Matching contour frame		Type	Cat. No.
for TS 32 ʎ	Type	DK 4 RA	
	Cat. No.	<b>0690960000</b>	<b>0690960000</b>
for TS 35 w	Type	DK 4 RA/35	
	Cat. No.	<b>0691060000</b>	<b>0691060000</b>

Matching contour frame		Type	Cat. No.
for TS 32 ʎ	Type	DKT 4 RA	
	Cat. No.	<b>0687460000</b>	<b>1115760000</b>

#### Accessories

Mounting rail (2 m lengths)		Type	Cat. No.	Qty.
		TS 32	<b>0122800000</b>	2 m
		TS 35 x 7.5	<b>0383400000</b>	2 m
		TS 35 x 15	<b>0498000000</b>	2 m
End bracket	for TS 32	EWK 1 (8.5)	<b>0206160000</b>	50
	for TS 35	EW 35 (8.5)	<b>0383560000</b>	50
End plate (thickness mm)		AP PA (1.5)	<b>0359260000</b>	20
Partition		TSch 4	<b>0363360000</b>	100
Socket for test plug		StB 8.5	<b>0215700000</b>	50
Test plug (pin diameter)		PS (ø 2.3)	<b>0180400000</b>	20
Cross-connection (preassembled)	2-pole	Q 2	<b>0336400000</b>	50
	3-pole	Q 3	<b>0336500000</b>	50
	4-pole	Q 4	<b>0336600000</b>	50
	10-pole	Q 10	<b>0368600000</b>	20
		VL 2	<b>0446700000</b>	-
Switchable cross-connection bracket		VH 10	<b>0446600000</b>	100
Connection sleeve		BS M 2.5 x 14	<b>0266800000</b>	100
Fixing screw		AD 4	<b>0303400000</b>	50
Cover plate (4 terminals)		BSK M 2.5 x 18	<b>0303300000</b>	100
Fixing screw (plastic)		QB 2*	<b>0482700000</b>	100
Cross connection bridge		QB 3*	<b>0482800000</b>	50
		QB 4*	<b>0482900000</b>	50
		QB 75 blank*	<b>0526400000</b>	10
		Insulation profile	<b>0526700000</b>	-

Mounting rail (2 m lengths)		Type	Cat. No.	Qty.
		TS 32	<b>0122800000</b>	2 m
		TS 35 x 7.5	<b>0383400000</b>	2 m
		TS 35 x 15	<b>0498000000</b>	2 m
End bracket	for TS 32	EWK 1 (8.5)	<b>0206160000</b>	50
	for TS 35	EW 35 (8.5)	<b>0383560000</b>	50
End plate (thickness mm)		AP PA (1.5)	<b>0359260000</b>	20
Partition		TSch 4	<b>0363360000</b>	100
Socket for test plug		StB 8.5	<b>0215700000</b>	50
Test plug (pin diameter)		PS (ø 2.3)	<b>0180400000</b>	20
Cross-connection (preassembled)	2-pole	Q 2	<b>0336400000</b>	50
	3-pole	Q 3	<b>0336500000</b>	50
	4-pole	Q 4	<b>0336600000</b>	50
	10-pole	Q 10	<b>0368600000</b>	20
		VL 2	<b>0446700000</b>	-
Switchable cross-connection bracket		VH 10	<b>0446600000</b>	100
Connection sleeve		BS M 2.5 x 14	<b>0266800000</b>	100
Fixing screw		AD 4	<b>0303400000</b>	50
Cover plate (4 terminals)		BSK M 2.5 x 18	<b>0303300000</b>	100
Fixing screw (plastic)		QB 2*	<b>0482700000</b>	100
Cross connection bridge		QB 3*	<b>0482800000</b>	50
		QB 4*	<b>0482900000</b>	50
		QB 75 blank*	<b>0526400000</b>	10
		Insulation profile	<b>0526700000</b>	-

Mounting rail (2 m lengths)		Type	Cat. No.	Qty.
		TS 32	<b>0122800000</b>	2 m
		TS 35 x 7.5	<b>0383400000</b>	2 m
		TS 35 x 15	<b>0498000000</b>	2 m
End bracket	for TS 32	EWK 1 (8.5)	<b>0206160000</b>	50
	for TS 35	EW 35 (8.5)	<b>0383560000</b>	50
End plate (thickness mm)		AP PA (1.5)	<b>0687560000</b>	20
Partition		TSch 4	<b>0363360000</b>	100
Socket for test plug		StB 8.5	<b>0215700000</b>	50
Test plug (pin diameter)		PS (ø 2.3)	<b>0180400000</b>	20
Cross-connection (preassembled)	2-pole	Q 2	<b>0336400000</b>	50
	3-pole	Q 3	<b>0336500000</b>	50
	4-pole	Q 4	<b>0336600000</b>	50
	10-pole	Q 10	<b>0368600000</b>	20
		VL 2	<b>0446700000</b>	-
Switchable cross-connection bracket		VH 10	<b>0446600000</b>	100
Connection sleeve		BS M 2.5 x 14	<b>0266800000</b>	100
Fixing screw		AD 4	<b>0303400000</b>	50
Cover plate (4 terminals)		BSK M 2.5 x 18	<b>0303300000</b>	100
Fixing screw (plastic)		QB 2*	<b>0482700000</b>	100
Cross connection bridge		QB 3*	<b>0482800000</b>	50
		QB 4*	<b>0482900000</b>	50
		QB 75 blank*	<b>0526400000</b>	10
		Insulation profile	<b>0526700000</b>	-

\* Accessories see terminals catalogue

# Housings

## Terminals

### WDK 2.5

### WDK 2.5 F

### WDK 2.5 FF

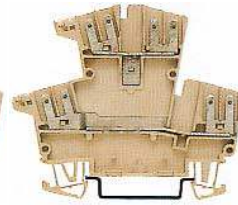
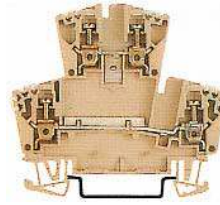

Dimensions	WDK 2.5		WDK 2.5 F	WDK 2.5 FF						
Terminal width (+fitting tolerance 0.2)	5 mm	5 mm	5 mm	5 mm						
Insulating stripping length	10 mm	10 mm	10 mm	-						
<b>Connection data</b>										
Screw connection, solid	0.5...4 mm <sup>2</sup>	0.5...4 mm <sup>2</sup>	0.5...4 mm <sup>2</sup>							
Screw connection, stranded	0.5...2.5 mm <sup>2</sup>	0.5...2.5 mm <sup>2</sup>	0.5...2.5 mm <sup>2</sup>							
Conductor cross-section	AWG 26...4	AWG 26...4	AWG 26...4							
Tightening torque range	0.4 - 0.7 Nm		0.4 - 0.7 Nm							
Torque phase with DMS 2 electric screwdriver	1		1							
<b>Rated data acc. to VDE</b>										
Rated cross-section	2.5 mm <sup>2</sup>		2.5 mm <sup>2</sup>	1 mm <sup>2</sup>						
Rated voltage	380 V~		380 V~	380 V~						
Rated current	26 A		12 A (2 x 6 A)	12 A (2 x 6 A)						
Power loss	0.5 W		0.5 W	0.5 W						
<b>Connection diagram</b>										
<b>Ordering data</b>										
Terminal										
for TS 32 y	Type									
	Cat. No.									
for TS 35 w	Type	WDK 2.5	WDK 2.5 F	WDK 2.5 FF						
	Cat. No.	<b>1023200000</b>	<b>1021600000</b>	<b>1021700000</b>						
Matching contour frame										
for TS 32 y	Type									
	Cat. No.									
for TS 35 w	Type	WZR WDK 2.5	WZR WDK 2.5	WZR WDK 2.5						
	Cat. No.	<b>1074000000</b>	<b>1074000000</b>	<b>1074000000</b>						
<b>Accessories</b>	Type	Cat. No.	Qty.	Type	Cat. No.	Qty.	Type	Cat. No.	Qty.	
Mounting rail (2 m lengths)	TS 35 x 7.5	<b>0383400000</b>	2 m	TS 35 x 7.5	<b>0383400000</b>	2 m	TS 35 x 7.5	<b>0383400000</b>	2 m	
	slotted	<b>0514500000</b>	2 m	slotted	<b>0514500000</b>	2 m	slotted	<b>0514500000</b>	2 m	
	TS 35 x 15	<b>0498000000</b>	2 m	TS 35 x 15	<b>0498000000</b>	2 m	TS 35 x 15	<b>0498000000</b>	2 m	
End bracket (thickness mm)	for TS 35	EW 35 (8.5)	<b>0383560000</b>	50	EW 35 (8.5)	<b>0383560000</b>	50	EW 35 (8.5)	<b>0383560000</b>	50
End plate (thickness mm)		WAP	<b>1059100000</b>	100	WAP	<b>1059100000</b>	100	WAP	<b>1059100000</b>	100
Cross-connection (preassembled)	2-pole	WQV 2.5	<b>1053660000</b>	50	WQV 2.5	<b>1053660000</b>	50	WQV 2.5	<b>1053660000</b>	50
	3-pole	WQV 2.5	<b>1053760000</b>	50	WQV 2.5	<b>1053760000</b>	50	WQV 2.5	<b>1053760000</b>	50
	4-pole	WQV 2.5	<b>1053860000</b>	50	WQV 2.5	<b>1053860000</b>	50	WQV 2.5	<b>1053860000</b>	50
	10-pole	WQV 2.5	<b>1054460000</b>	50	WQV 2.5	<b>1054460000</b>	50	WQV 2.5	<b>1054460000</b>	50

# Housings

## Housings

### EG 1

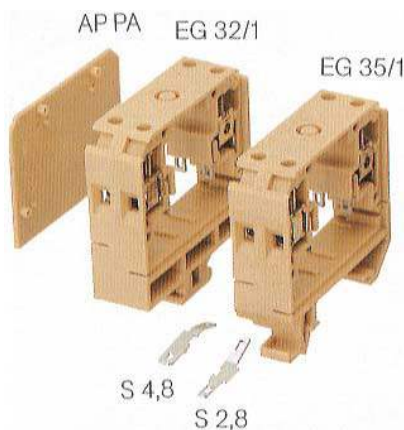

### EG 2

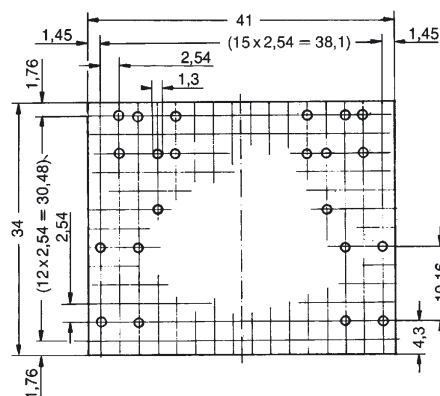
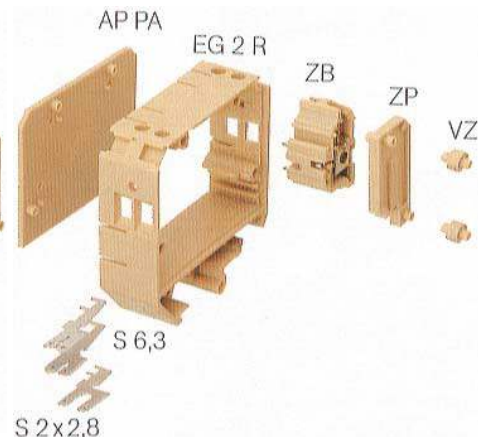

Rated data				Rated data			
Reference voltage acc. to VDE 0110 1/89	300 V			300 V			
Pollution severity	2			2			
Overtoltage category	II			II			
Current	10 A			10 A			
Power loss (when mounted in row)	1 W			1 W			
Protection class	IP 20			IP 20			
Flammability acc. to UL level	V-2			V-2			
Upper temperature limit	100 °C			100 °C			
Connection data				Connection data			
Screw connection solid	0.5...4 mm <sup>2</sup>			0.5...4 mm <sup>2</sup>			
Screw connection stranded	0.5...2.5 mm <sup>2</sup>			0.5...2.5 mm <sup>2</sup>			
Tightening torque range	0.5 - 1.0 Nm			0.5 - 1.0 Nm			
Torque phase with DMS 2 electric screwdriver	2			2			
Ordering data				Ordering data			
Housing frame	Type	Cat. No.	Qty.	Type	Cat. No.	Qty.	
	EG 32/1 for TS 32	<b>0453560000</b>	20	EG 2 R	<b>0508860000</b>	20	
	EG 35/1 for TS 35	<b>0453860000</b>	20				
End plate	AP PA	<b>0453660000</b>	20	AP PA	<b>0453660000</b>	20	
Combi foot, latchable							
Assembly plate							
Clamping yoke unit, right				ZB-R	<b>0495960000</b>	20	
Clamping yoke unit, left				ZB-L	<b>0495860000</b>	20	
Intermediate plate	ZP	<b>0453760000</b>	20	ZP	<b>0453760000</b>	20	
Connection spigot	VZ	<b>0510260000</b>	50	VZ	<b>0510260000</b>	50	
Connection tab 0.8 x 6.3 mm							
Connection tab 2 x 0.8 x 2.8 mm							
Tab / solder lug 0.8 x 2.8 mm	S 2.8	<b>0475800000</b>	20	S 6.3	<b>0496100000</b>	100	
Tab / solder lug 0.8 x 4.8 mm	S 4.8	<b>0475700000</b>	20	S 2 x 2.8	<b>0163500000</b>	50	
Printed circuit board, copper-coated							
Printed circuit board 5.08 pitch							
Dimensions				Dimensions			
see page	306, Fig. I			306, Fig. II			

# Housings

## EG 3

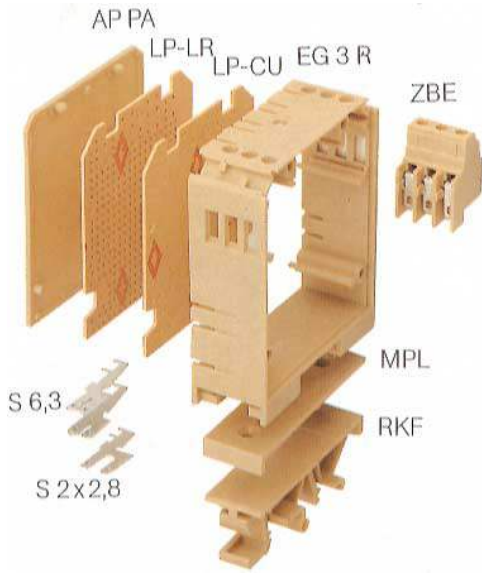

## EG 4

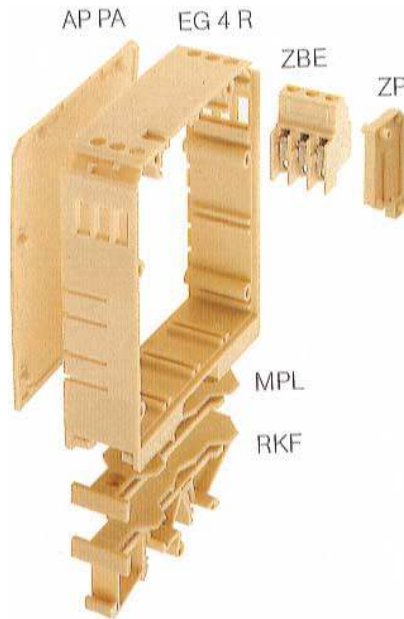

## EG 5

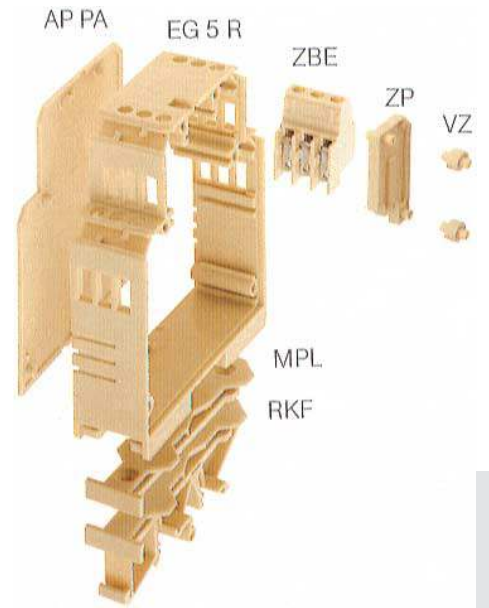

300 V
2
II
10 A
1.5 W
IP 20
V - 2
100 °C
0.5...4 mm <sup>2</sup>
0.5...2.5 mm <sup>2</sup>
0.4 - 0.8 Nm
1

Type	Cat. No.	Qty.
EG 3 R	<b>0163960000</b>	15
AP PA	<b>0133760000</b>	20
RKF	<b>0163860000</b>	20
MPL	<b>0158560000</b>	50
ZBE	<b>0138360000</b>	50
ZBE	<b>0138360000</b>	50
VZ	<b>0510260000</b>	50
S 6.3	<b>0496100000</b>	100
S 2 x 2.8	<b>0163500000</b>	50
LP-CU	<b>0167300000</b>	-
LP-LR	<b>0167400000</b>	-

307, Fig. V

300 V
2
III
10 A
1.6 W
IP 20
V - 2
100 °C
0.5...4 mm <sup>2</sup>
0.5...2.5 mm <sup>2</sup>
0.4 - 0.8 Nm
1

Type	Cat. No.	Qty.
EG 4 R	<b>1116560000</b>	-
AP PA	<b>1116060000</b>	20
RKF	<b>1116260000</b>	20
MPL	<b>1116360000</b>	50
ZBE	<b>0138360000</b>	50
ZBE	<b>0138360000</b>	50
VZ	<b>0510260000</b>	50
ZP	<b>0453760000</b>	-

307, Fig. VI

300 V
2
III
1 A
1.6 W
IP 20
V - 2
100 °C
0.5...4 mm <sup>2</sup>
0.5...2.5 mm <sup>2</sup>
0.5 - 0.8 Nm
1

Type	Cat. No.	Qty.
EG 5 R	<b>1116860000</b>	-
AP PA	<b>1116160000</b>	20
RKF	<b>1116260000</b>	20
MPL	<b>1116360000</b>	50
ZBE	<b>0138360000</b>	50
ZBE	<b>0138360000</b>	50
VZ	<b>0510260000</b>	50
ZP	<b>0453760000</b>	-

307, Fig. VII

# Housings

## Housings for pluggable printed circuit boards

Housing version	Polyamide PA 6.6
Flammability class	U2 (UL 94)
Colour	grey

### Notes:

BLZ may only be actuated with the supply disconnected. If small power ratings need to be switched for operating reasons, empirical values are available on request.

Description
Housing base completely assembled with locking foot, not cross-connectable
Housing base completely assembled with locking foot, cross-connectable
Top part with transparent cover/top unit
Pin header 5.08/3-pole orange; right
Pin header 5.08/3-pole orange; left
Connector socket 2-pole for BLZ 5.08/2 screw terminal
- orange
- black
Other colours are available on request
Connector socket 3-pole for BLZ 5.08/3 terminal
- orange
- black
Other colours are available on request
Connector socket 2-pole for BLZ 5.08/3 tension clamp terminal
- orange
- black
Connector socket 3-pole for BLZ 5.08/3 tension clamp terminal
- orange
- black

### Accessories

Cross-connection ZQV 2.5N/2 black
Cross-connection ZQV 2.5N/2 red
Cross-connection ZQV 2.5N/2 blue
Cross-connection ZQV 2.5N/2 yellow
Coding elements for BLZ BLZ KO black
Coding elements for BLZ BLZ KO orange

### WS connector marker

WS15/5 Multicard*
WS10/5 Multicard *
WS10/5 Neutral*
Screw cap
Power loss, arranged side by side, type

### Ordering example WAVEBOX S 22.5

Housing base completely assembled with locking foot, not cross-connectable
Top part with transparent cover/top unit
Pin header 5.08/3-pole orange; right
Pin header 5.08/3-pole orange; left
Connector socket 3-pole for BLZ 5.08/3 screw terminal, orange

\* Marker see page 317 + 318

### Attention!

These WAVEBOX-housings are authorized only to be used in a closed control cubicle!

## WAVEBOX S 22.5



Type	Cat. No.	Qty.
WAVEBOX S 22.5	8426440000	10
WAVEBOX S 22.5 QV	8426450000	10
Head	8426460000	10
Pin header	8426620000	10
Pin header	8426630000	10
Connector socket	1526560000	100
Connector socket	1526510000	100
Connector socket	1707470000	100
Connector socket	1707700000	100

## WAVEBOX L 22.5



Type	Cat. No.	Qty.
WAVEBOX L 22.5	8426470000	10
WAVEBOX L 22.5 QV	8426480000	10
Head	8426490000	10
Pin header	8426620000	10
Pin header	8426630000	10
Connector socket	1526560000	100
Connector socket	1526510000	100
Connector socket	1707470000	100
Connector socket	1707700000	100

Dimension drawing, see page 308





# Housings

## Housings

## SEG-U/LPU

## EG 6

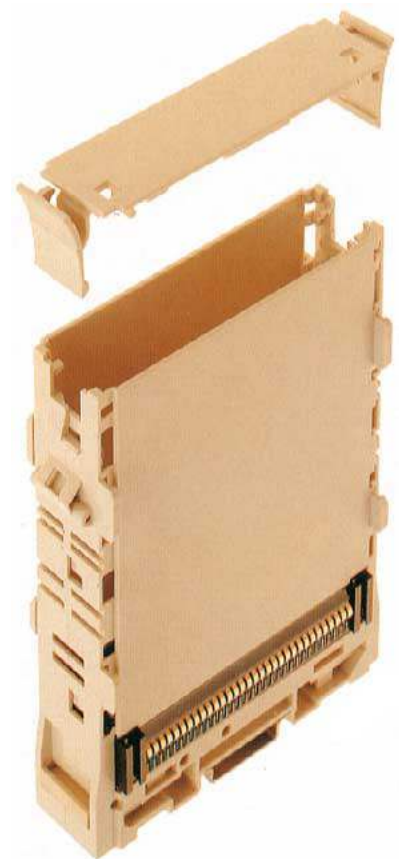
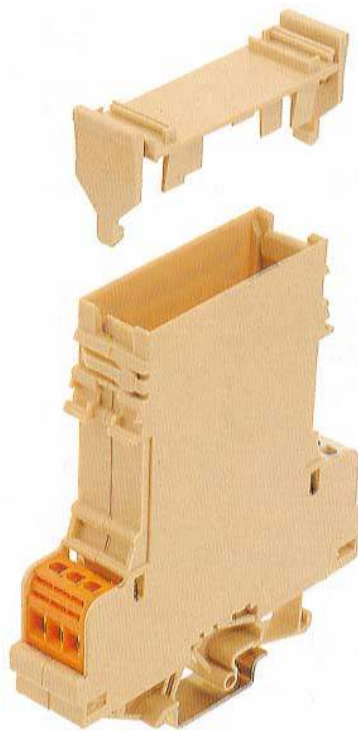

### Rated data

Reference voltage acc. to VDE 0110 1/89	50 V
Pollution severity	2
Overtoltage category	III
Current	1 A
Current-carrying capacity of bus contacts	
Volume resistance of bus contacts	
Printed circuit board dimensions	
Power loss (when mounted in row)	1.5 W
Protection class	IP 20
Flammability acc. to UL level	V -2
Upper temperature limit	100 °C

### Connection data

Screw connection solid	0.5...4 mm <sup>2</sup>
Screw connection stranded	0.5...2.5 mm <sup>2</sup>
Tightening torque range	0.5 Nm
Torque phase with electric screwdriver DMS 2	1

### Ordering data

	Type	Cat. No.	Qty.
Housing frame	Housing SEG/U	<b>8007870000</b>	-
	Cover plate	<b>8066100000</b>	-
End plate			
Combi foot, latchable			
Assembly plate			
Clamping yoke unit, right			
Clamping yoke unit, left			
Intermediate plate			
Connection spigot			
Connection tab 0.8 x 6.3 mm			
Connection tab 2 x 0.8 x 2.8 mm			
Tab / solder lug 0.8 x 2.8 mm			
Tab / solder lug 0.8 x 4.8 mm			
Printed circuit board, copper-coated			
Printed circuit board 2.54 pitch			

### Dimensions

See page	307
----------	-----

Reference voltage acc. to VDE 0110/1.89	32 V nach VDE 0110/1.89
Pollution severity	2
Overtoltage category	III
Current	
Current-carrying capacity of bus contacts	1 A/δ <sub>U</sub> 50 °C
Volume resistance of bus contacts	12 mΩ
Printed circuit board dimensions	100 x 120 x 1.8 mm
Power loss (when mounted in row)	
Protection class	IP 00
Flammability acc. to UL level	V - 2
Upper temperature limit	100 °C

Screw connection solid	
Screw connection stranded	
Tightening torque range	
Torque phase with electric screwdriver DMS 2	

	Type	Cat. No.	Qty.
Housing frame	Housing SEG/U	<b>8007870000</b>	-
	Cover plate	<b>8066100000</b>	-
End plate			
Combi foot, latchable			
Assembly plate			
Clamping yoke unit, right			
Clamping yoke unit, left			
Intermediate plate			
Connection spigot			
Connection tab 0.8 x 6.3 mm			
Connection tab 2 x 0.8 x 2.8 mm			
Tab / solder lug 0.8 x 2.8 mm			
Tab / solder lug 0.8 x 4.8 mm			
Printed circuit board, copper-coated			
Printed circuit board 2.54 pitch			

	Type	Cat. No.	Qty.
Housing frame	Housing SEG/U	<b>8007870000</b>	-
	Cover plate	<b>8066100000</b>	-
End plate			
Combi foot, latchable			
Assembly plate			
Clamping yoke unit, right			
Clamping yoke unit, left			
Intermediate plate			
Connection spigot			
Connection tab 0.8 x 6.3 mm			
Connection tab 2 x 0.8 x 2.8 mm			
Tab / solder lug 0.8 x 2.8 mm			
Tab / solder lug 0.8 x 4.8 mm			
Printed circuit board, copper-coated			
Printed circuit board 2.54 pitch			

See page	307
----------	-----



# Housings

## Locking socket

### RS 45

Strip profile

### RS 70

Locking socket  
Individual parts

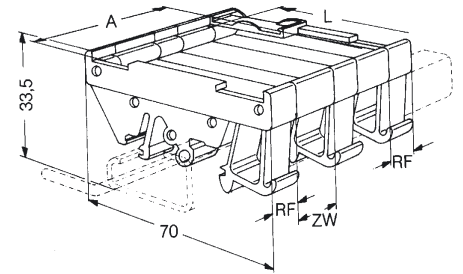

Dimensions	
Fixing foot	Total width: 45 mm
Spacer	Length: 1000 mm/2000 mm
Printed circuit board	For horizontal insertion of a printed circuit board
	Width: 42 (+0.5) mm
	Thickness: 1.8 (+0.15) mm (DIN 40802 T. 2)
	Length: optional/60...2000 mm
	Dim. of RS section: printed circuit board length – 4.5 mm
	Dim. of ADP section: printed circuit board length – 1 mm
	Example: circuit board length 160 mm, RS = 155.5 mm, ADP = 159 mm
Rated data	
Flammability acc. to UL level	V-0 / V-2 strip profile / accessories
Upper temperature limit	70 °C
Ordering data	
String profile	Type                      Cat. No.                      Qty.
	RS 45 (up to 2000 mm) <b>4027750000</b> 1
	RS 45 (up to 1000 mm) <b>8140880000</b> 1
Fixing foot right, with marking facility	
Fixing foot right, without marking facility	
Fixing foot left, without marking facility	
Fixing foot middle (intermediate foot)	
Fixing foot (RS 80/RS 100) for TS 32/TS 35	
Spacer 5 mm	
Spacer 15 mm	
Spacer 25 mm	
Spacer 30 mm	
Spacer 45 mm	
End plate for mounting on rail without cover	AP 45/LI    AP 45/RE <b>8143910000</b> <b>8143900000</b> 20
End plate for direct mounting without cover	AP 45/LI Di    AP 45/RE Di <b>8140870000</b> <b>8140860000</b> 20
End plate for mounting on rail with low cover	
End plate for direct mounting with low cover	
End plate for mounting on rail with high cover	
End plate for direct mounting with high cover	
Cover profile, low	
Cover profile, high	
Screws	30 x 14 <b>4011200000</b> –
Accessories	
Insert tag (unprinted)	
Protective strip, transparent	

Dimensions		
Width: 10 mm	Maß RF	
Width: 5 mm/15 mm/25 mm/30 mm/45 mm	Dim. ZW	
Width: RS-Br –2 mm (Ex.: RS=45 mm, LP=43 mm)	Dim. A	
Length: 67.8 (–0.2) mm	Dim. L	
Thickness: 1.6 (±0.2) mm (DIN 40802 Part 2)		
Rated data		
V-2	100 °C	
Ordering data		
Type                      Cat. No.                      Qty.		
RFB	<b>0119560000</b>	
RFO	<b>0126260000</b>	20
RF	<b>0119660000</b>	20
RFM	<b>0213760000</b>	20
ZW 5	<b>0119760000</b>	20
ZW 15	<b>0119860000</b>	20
ZW 25	<b>0126160000</b>	20
ZW 30	<b>0119960000</b>	20
ZW 45	<b>0120060000</b>	20
ESO 7	<b>0515200000</b>	–
SSt 7	<b>0515300000</b>	100

Dimensions		
Width: 10 mm	Maß RF	
Width: 5 mm/15 mm/25 mm/30 mm/45 mm	Dim. ZW	
Width: RS-Br –2 mm (Ex.: RS=45 mm, LP=43 mm)	Dim. A	
Length: 67.8 (–0.2) mm	Dim. L	
Thickness: 1.6 (±0.2) mm (DIN 40802 Part 2)		
Rated data		
V-2	100 °C	
Ordering data		
Type                      Cat. No.                      Qty.		
RFB	<b>0119560000</b>	
RFO	<b>0126260000</b>	20
RF	<b>0119660000</b>	20
RFM	<b>0213760000</b>	20
ZW 5	<b>0119760000</b>	20
ZW 15	<b>0119860000</b>	20
ZW 25	<b>0126160000</b>	20
ZW 30	<b>0119960000</b>	20
ZW 45	<b>0120060000</b>	20
ESO 7	<b>0515200000</b>	–
SSt 7	<b>0515300000</b>	100

# Housings

## RS 80

Strip profile

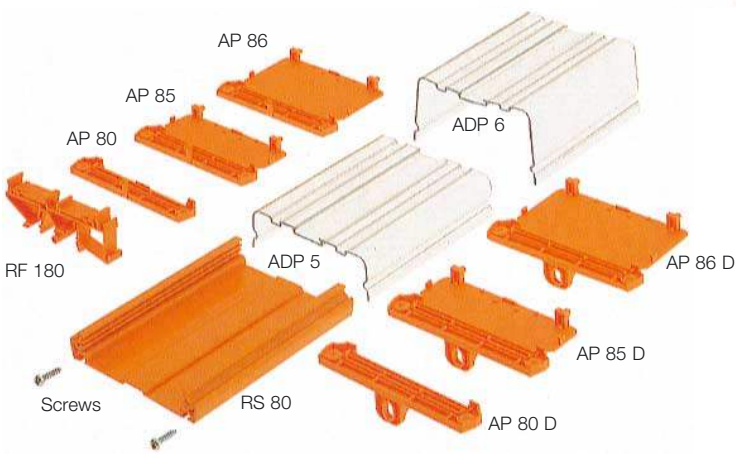

## RS 100

Strip profile for Euro-cards

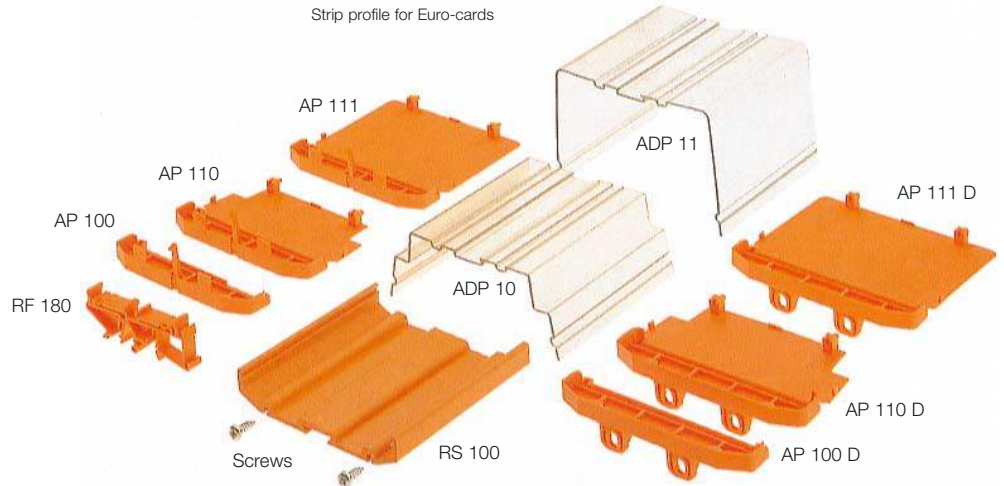

AP RF80 RE/LT

Total width:	84 mm
Length:	2000 mm

For horizontal insertion of a printed circuit board

Width:	67.8 (+0.2) mm
Thickness:	1.8 (+0.15) mm (DIN 40802 T. 2)

Dim. RS section printed circuit board length -4.5 mm  
 Dim. ADP section printed circuit board length -2 mm  
 Example: circuit board length 160 mm, RS = 155.5 mm, ADP = 158 mm

V-0 / V-2 strip profile / accessories  
 70 °C

Type	orange (RAL 2000)	grey (RAL 7032)	Qty.
RS 80 (2000 mm) grey		<b>4183130000</b>	1
RS 80 (2000 mm) orange	<b>4157440000</b>		1
RF 180	<b>1324460000</b>	<b>1773400000</b>	20
AP 80	<b>1324260000</b>	<b>8320300000</b>	20
AP 80 D	<b>1324360000</b>		20
AP RF 80 RE		<b>8156200000</b>	-
AP RF 80 LT		<b>8156210000</b>	-
AP 85	<b>1410860000</b>		20
AP 85 D	<b>1411060000</b>		20
AP 86	<b>1410960000</b>		20
AP 86 D	<b>1411160000</b>		20
ADP 5 (1000 mm)	<b>4167150000</b>		-
ADP 6 (1000 mm)	<b>4167160000</b>		-
30 x 14	<b>4011200000</b>		-

Total width:	104 mm
Length:	2000 mm/160 mm

For horizontal insertion of a printed circuit board

Width:	100 (+0.5) mm
Thickness:	1.8 (+0.5) mm (DIN 40802 Part 2)

Dim. RS section printed circuit board length -4.5 mm  
 Dim. ADP section printed circuit board length -1 mm  
 Example: circuit board length 160 mm, RS = 155.5 mm, ADP = 159 mm

V-0 / V-2 strip profile / accessories  
 70 °C

Type	orange (RAL 2000)	grey (RAL 7032)	Qty.
RS 100 (2000 mm) grey		<b>4010870000</b>	1
RS 100 (2000 mm) orange	<b>4144870000</b>		1
RS 100 (155 mm)	<b>4148400000</b>		1
RF 180	<b>1324460000</b>	<b>1773400000</b>	20
AP 100	<b>1185060000</b>	<b>1773410000</b>	20
AP 100 D	<b>1185160000</b>		20
AP 110	<b>1185260000</b>		20
AP 110 D	<b>1185360000</b>		20
AP 111	<b>1185460000</b>		20
AP 111 D	<b>1185560000</b>		20
ADP 10 (2000 mm)	<b>4169320000</b>		(2 m)
ADP 11 (2000 mm)	<b>4169330000</b>		(2 m)
40 x 14	<b>4019420000</b>		-

# Housings

## Housings EG.../RST OST

Dimensions  
 Connection data  
 Accessories

### EGR/EG 7

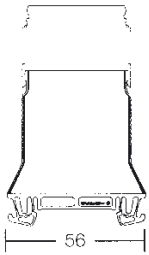

### EGR/EGO



### RST/EG 7

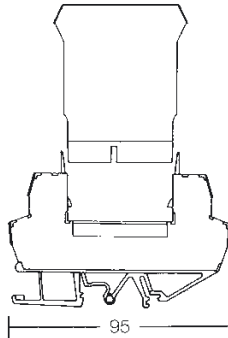

### EG 8 / EG 12

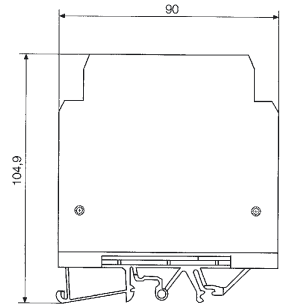
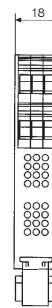
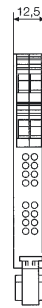

EG 8

EG 12

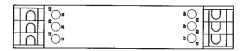

	EG 7/35 for TS 35	EG 7/combi foot
Width (mm)	10	10
Height (mm)		
with TS 35 x 7.5	92	96
with TS 35 x 15	100	103
with TS 32		100

RST/OST EG 7	
Width (mm)	10
Height assembled (mm)	
823472 for TS 32	
with TS 35 x 7.5	91
with TS 35 x 15	99
819383 with combi foot	
with TS 35 x 7.5	93
with TS 35 x 15	101
with TS 32	97

Dimensions	
<b>EG 8</b>	
Width (mm)	12.5
Height (mm)	104.9
<b>EG 12</b>	
Width (mm)	18
Height (mm)	104.9

# Housings

## Housings

Dimensions  
Connection data  
Accessories

### DK 5

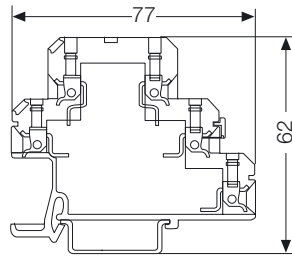

### DK 6

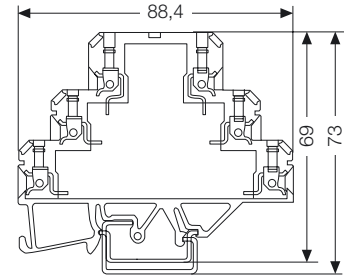

Dimensions	
Terminal width (+ fitting tolerance 0.2 mm)	
Insulating stripping length	
Connection data	
Screw connection, solid	
Screw connection, stranded	
Connection cross-section	
Accessories	
Mounting rail (2 m lengths)	y
	w
	v
End bracket	for TS 32
	for TS 35
End plate	
Marking material*	

DK 5	
Terminal width	6 mm
Insulating stripping length	9 mm
Connection data	
Screw connection, solid	0.5...4 mm <sup>2</sup>
Screw connection, stranded	0.5...4 mm <sup>2</sup>
Connection cross-section	AWG 20...12
Accessories	
Type	Cat. No.
TS 32	<b>0122800000</b>
TS 35 x 7.5	<b>0383400000</b>
TS 35 x 15	<b>0498000000</b>
EWK 2	<b>0199360000</b>
EW 35	<b>0383560000</b>
AP	<b>8268870000</b>
dekafix 5	

DK 6	
Terminal width	8 mm
Insulating stripping length	9 mm
Connection data	
Screw connection, solid	0.5...4 mm <sup>2</sup>
Screw connection, stranded	0.5...4 mm <sup>2</sup>
Connection cross-section	AWG 20...12
Accessories	
Type	Cat. No.
TS 32	
TS 35 x 7.5	<b>0383400000</b>
TS 35 x 15	<b>0498000000</b>
EWK 2	<b>0199360000</b>
EW 35	<b>0383560000</b>
AP	<b>8324560000</b>
dekafix 5	

\*For more information see sectional catalogue 5/installation products

## Housings miniconditioner MCZ

Dimensions  
Connection data  
Accessories

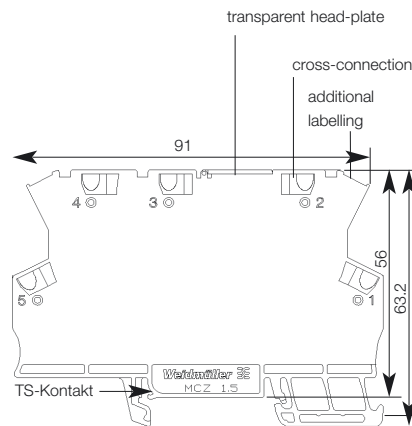

Dimensions	
Width (mm) + fitting tolerance 0.2	6
Insulating stripping length (mm)	6
Connection data	
Z-spring connection, solid	0.5...1.5 mm <sup>2</sup>
Z-spring connections, stranded	0.5...1.5 mm <sup>2</sup>
Connection cross-section	AWG 26...16
Accessories	
Mounting rail (2 m lengths) w	
Mounting rail (2 m lengths) v	
End plate	
End bracket for TS 35	
Cross-connection (pluggable)	

MCZ	
Terminal width	6 mm
Insulating stripping length	6 mm
Connection data	
Screw connection, solid	0.5...1.5 mm <sup>2</sup>
Screw connection, stranded	0.5...1.5 mm <sup>2</sup>
Connection cross-section	AWG 26...16
Accessories	
Type	Cat. No.
TS 35 x 7.5	<b>0383400000</b>
TS 35 x 15	<b>0498000000</b>
APMCZ 1.5	<b>8389030000</b>
EW 35	<b>0383560000</b>
EW 35	<b>0383560000</b>
ZQV 4 2-pole	<b>1608950000</b>
ZQV 4 3-pole	<b>1608960000</b>
ZQV 4 4-pole	<b>1608970000</b>
ZQV 4 5-pole	<b>1608980000</b>
ZQV 4 6-pole	<b>1608990000</b>
ZQV 4 7-pole	<b>1609000000</b>
ZQV 4 8-pole	<b>1609010000</b>
ZQV 4 9-pole	<b>1609020000</b>
ZQV 4 10-pole	<b>1609030000</b>

# Housings

## Housings EG.../EG-U/LPU

Dimensions  
Connection data  
Accessories

EG 1 - Fig. I

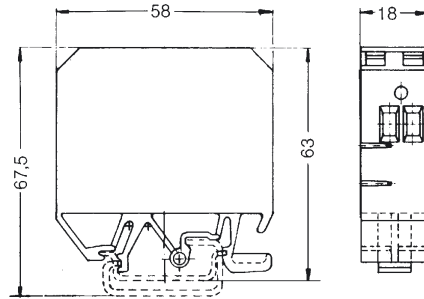

EG 2 - Fig. II

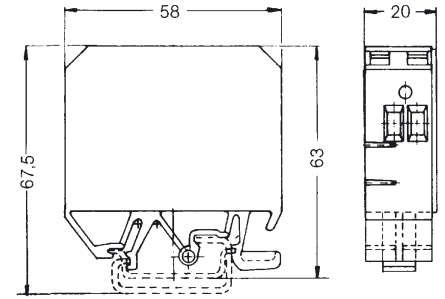

Dimensions	
Terminal width (+fitting tolerance 0.2 mm)	18 mm
Insulating stripping length	12 mm
Connection data	
Screw connection, solid	0.5...6 mm <sup>2</sup>
Screw connection, stranded	0.5...4 mm <sup>2</sup>
Connection cross-section	AWG 20...12
Accessories	
Mounting rail (2 m lengths)	Y
	W
	U
End bracket	for TS 32
	for TS 35
Cross connection wire: 80 mm long, 50-pole/1 mm <sup>2</sup>	
Marking material*	

Type	Cat. No.
TS 32	0122800000
TS 35 x 7.5	0383400000
TS 35 x 15	0498000000
EKW 2	0199360000
EW 35	0383560000
QD 50/grey	0238700000
dekafix 5	

Type	Cat. No.
TS 32	0122800000
TS 35 x 7.5	0383400000
TS 35 x 15	0498000000
EKW 2	0199360000
EW 35	0383560000
QD 50/grey	0238700000
dekafix 5	

EG 2 - Fig. III

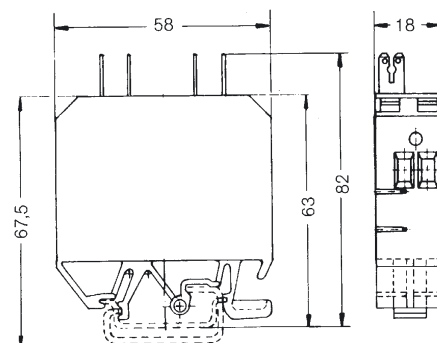

EG 2 - Fig. IV

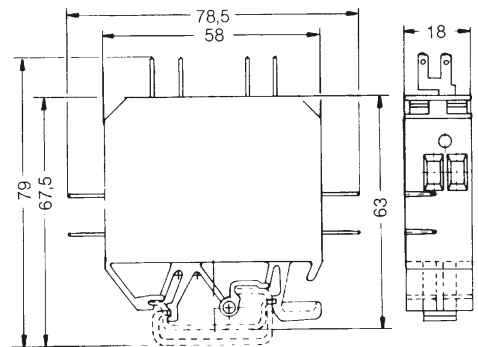

Dimensions	
Terminal width (+fitting tolerance 0.2 mm)	18 mm
Insulating stripping length	
Connection data	
Screw connection, solid	
Screw connection, stranded	
Tab connection (DIN 46247)	2x 0.8 x 2.8 mm or 1x 0.8 x 6.3 mm
Connection cross-section	
Accessories	
Mounting rail (2 m lengths)	Y
	W
	U
End bracket	for TS 32
	for TS 35
Cross connection wire: 80 mm long, 50-pole/1 mm <sup>2</sup>	
Marking material*	

Type	Cat. No.
TS 32	0122800000
TS 35 x 7.5	0383400000
TS 35 x 15	0498000000
EKW 2	0199360000
EW 35	0383560000
QD 50/grey	0238700000
dekafix 5	

Type	Cat. No.
TS 32	0122800000
TS 35 x 7.5	0383400000
TS 35 x 15	0498000000
EKW 2	0199360000
EW 35	0383560000
QD 50/grey	0238700000
dekafix 5	

# Housings

EG 3 - Fig. V

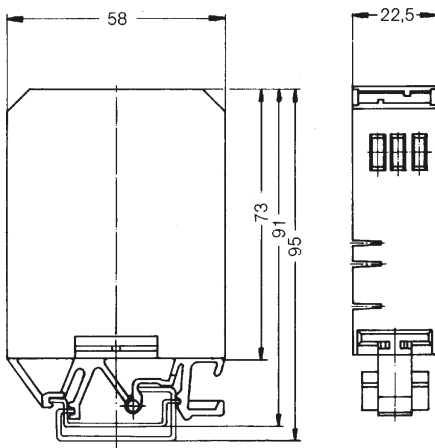

with assembly plate MPL

22.5 mm  
17 mm

0.5...4 mm<sup>2</sup>  
0.5...2.5 mm<sup>2</sup>

Type	Cat. No.
TS 32	0122800000
TS 35 x 7.5	0383400000
TS 35 x 15	0498000000
EKW 2	0199360000
EW 35	0383560000
QD 50/grey	0238700000
<b>dekafix 6.5</b>	

SEG-U/LPU

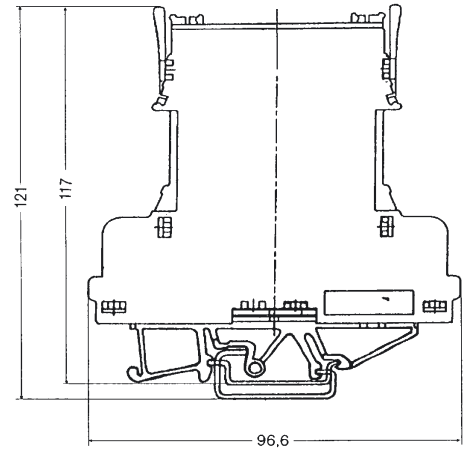

with assembly plate MPL

20 mm  
17 mm

0.5...4 mm<sup>2</sup>  
0.5...2.5 mm<sup>2</sup>  
AWG 26...14

Type	Cat. No.
TS 32	0122800000
TS 35 x 7.5	0383400000
TS 35 x 15	0498000000
EKW 2	0199360000
EW 35	0383560000
QD 50/grey	0238700000
<b>dekafix 5</b>	

EG 4 - Fig. VI

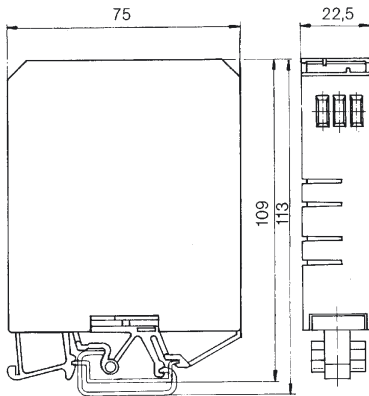

22.5 mm  
17 mm

0.5...4 mm<sup>2</sup>  
0.5...2.5 mm<sup>2</sup>  
AWG 22...12

Type	Cat. No.
TS 32	0122800000
TS 35 x 7.5	0383400000
TS 35 x 15	0498000000
EKW 2	0199360000
EW 35	0383560000
QD 50/grey	0238700000
<b>dekafix 6.5</b>	

EG 5 - Fig. VII

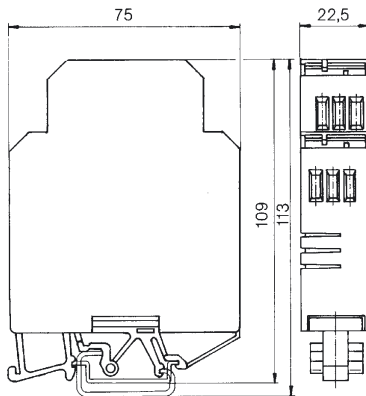

22.5 mm  
17 mm

0.5...4 mm<sup>2</sup>  
0.5...2.5 mm<sup>2</sup>  
AWG 22...12

Type	Cat. No.
TS 32	0122800000
TS 35 x 7.5	0383400000
TS 35 x 15	0498000000
EKW 2	0199360000
EW 35	0383560000
QD 50/grey	0238700000
<b>dekafix 6.5</b>	

EG 6

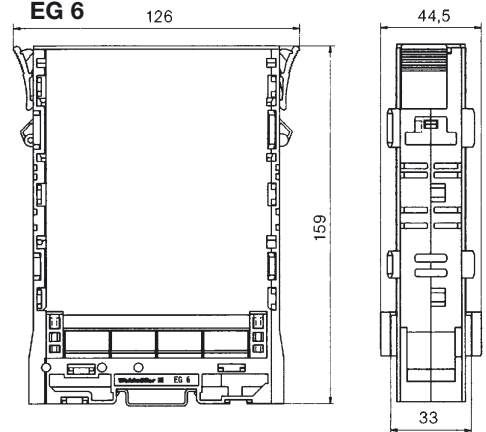

Anreihmaß

20 mm  
17 mm

0.5...4 mm<sup>2</sup>  
0.5...2.5 mm<sup>2</sup>  
AWG 26...14

Type	Cat. No.
TS 32	0122800000
TS 35 x 7.5	0383400000
TS 35 x 15	0498000000
EKW 2	0199360000
EW 35	0383560000
QD 50/grey	0238700000
<b>dekafix 5</b>	



# Housings

## WAVEBOX S 22.5

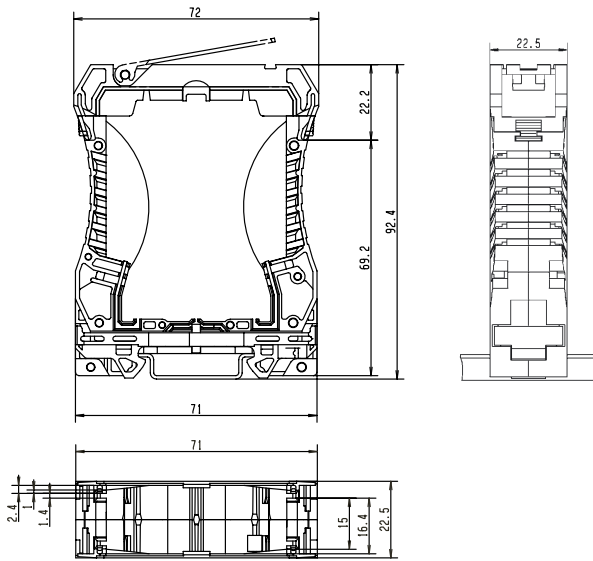

## WAVEBOX L 22.5

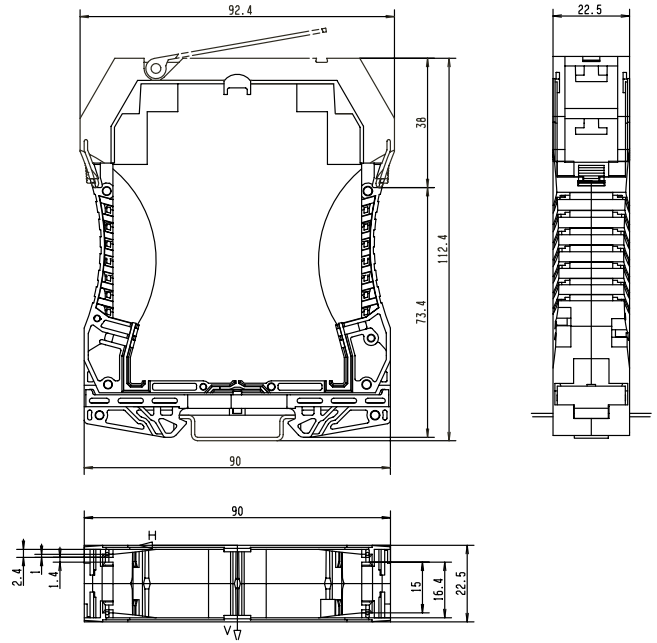

## Printed circuit board S 22.5

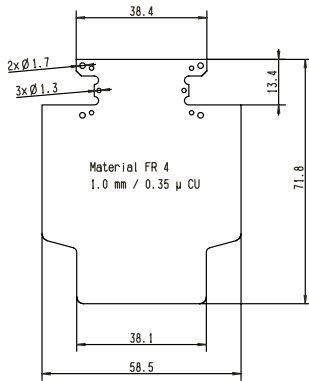

## Printed circuit board L 22.5

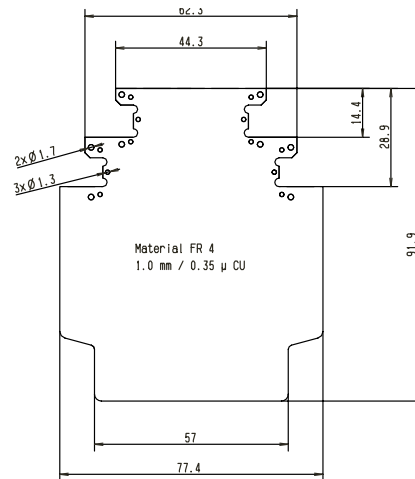

## WAVEBOX 12.5

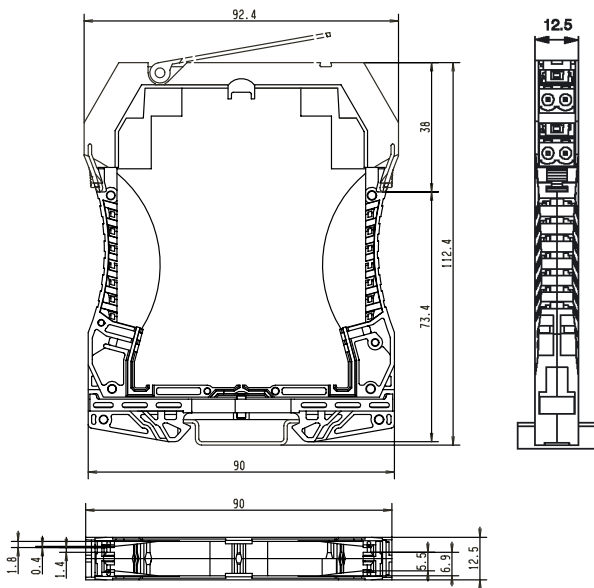

## WAVEBOX 17.5

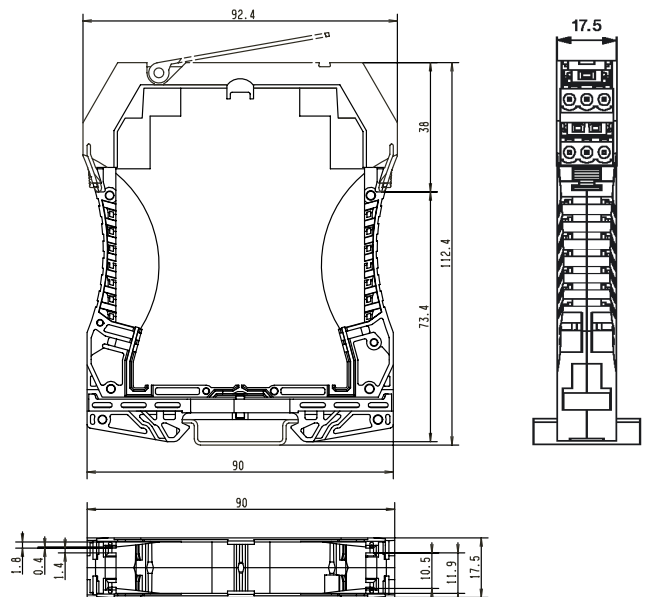

# Housings

## Socket blocks BLZ 5.08 / BLZF 5.08

Materials data	BLZ 5.08/SL 5.08	BLZF 5.08
Insulating material	PBT	PBT
Colour	orange	orange
Temperature range	-20.. +100 °C	-20.. +100 °C
Flammability class	UL 94 (VO)	UL 94 (VO)
Contact base material	CuSn	CuSn
Contact surface	tin plated	tin plated
Characteristic system values		
Pitch	5.08 mm	5.08 mm
Clearance	≥ 2.5 mm	≥ 3 mm
Creepage distance	≥ 4.0 mm	≥ 4.0 mm
Connection technology	Screw/solder connection	Tension clamp connection
Length of soldering pin	3.2/4.5 mm	
Mounting hole	∅ 1.3 + 0.1 mm	
Insulating stripping length	7 mm	7 mm
Terminal screw	M 2.5	
Isolations resistance	≥ 10 MΩ	≥ 10 <sup>5</sup> MΩ
Trough resistance	≤ 5 mΩ	≤ 5 mΩ
Connectable wires		
Terminal range	0.08...2.5 mm <sup>2</sup>	1.5 mm <sup>2</sup>
"e" solid H05(07)V-U	0.5...2.5 mm <sup>2</sup>	0.13...1.5 mm <sup>2</sup>
"f" flexible H05(07)V-K	0.5...2.5 mm <sup>2</sup>	0.13...2.5 mm <sup>2</sup>
"f" with ferrules		
according to DIN 46228/1	0.5...2.5 mm <sup>2</sup>	0.05...2.5 mm <sup>2</sup>
with plastic collar		
according to DIN 46228/4	0.5...1.5 mm <sup>2</sup>	1.5 mm <sup>2</sup>
AWG wire	28...14	26...14
Plug gauge acc. to EN 60947-1/10.91	A3	
Rated data according to VDE		<b>VDE 0110 2.79</b>
Rated cross-section	2.5mm <sup>2</sup>	2.5mm <sup>2</sup>
Rated current	12A <sup>1)</sup>	12A <sup>1)</sup>
Current capacity	see derating curves <sup>2)</sup>	see derating curves <sup>2)</sup>
Test voltage	2.0 kV~	2.0 kV~
Nominal torque	0.5 Nm	
Rated data according to		<b>VDE 0110 1.89</b>
Rated cross-section		1.5mm <sup>2</sup>
Rated current (T <sub>u</sub> =20°C)		12A <sup>3)</sup>
Rated voltage		250 V
Rated impulse voltage		4 kV
Pollution severity		3
Rated data according to UL	Rated data according to UL	
AWG wire	22...12	26...14
Rated current	10 A	10 A
Rated voltage, industriell	300 V~	300 V~
Operation tool		
Screwdriver type SD/SDI 5		
Approvals	List on request	Applied for

<sup>1)</sup> Rated cross-section and max. number of poles established from derating curve at 20 °C ambient temperature

<sup>2)</sup> Further derating curves on demand

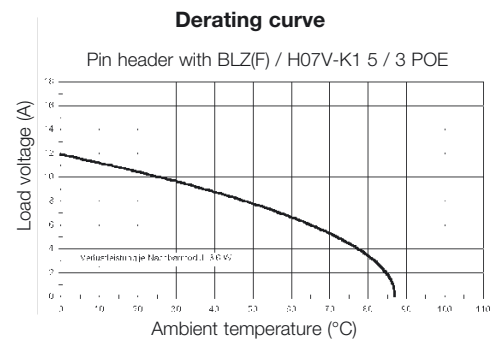
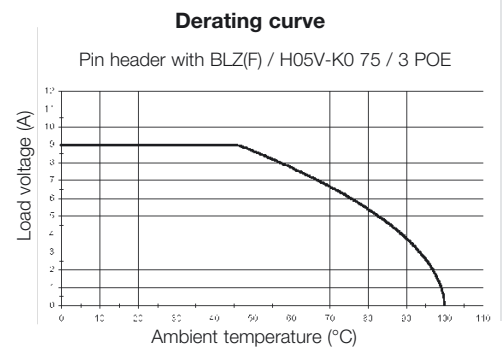
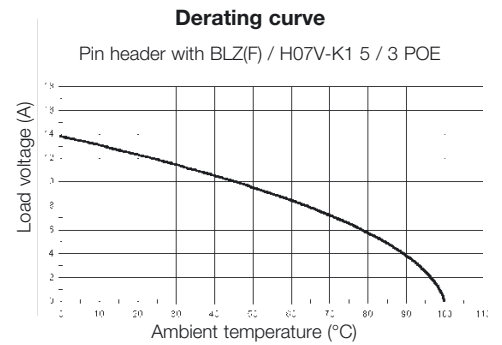

# Housings

## Locking socket profiles RS

RS 80

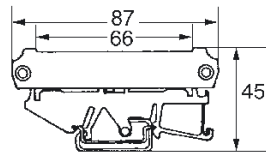

RS 100

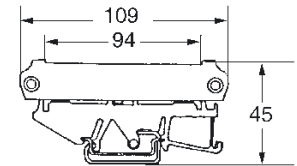

### Rail mounting without cover

### Direct mounting without cover

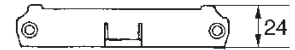
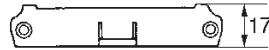

### Rail mounting with low cover

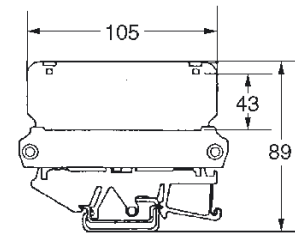
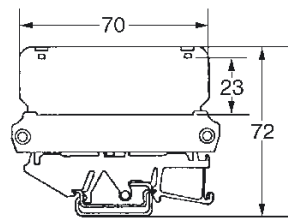

### Direct mounting with low cover

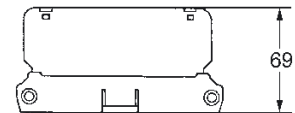
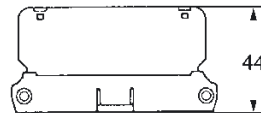

### Rail mounting with high cover

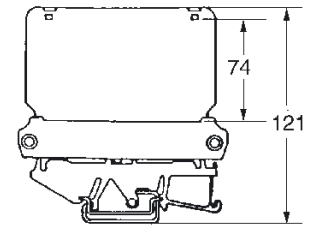
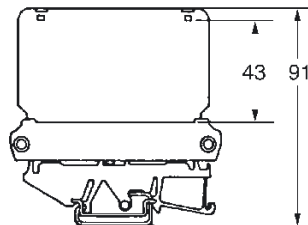

### Direct mounting with high cover

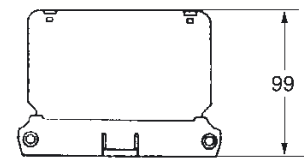
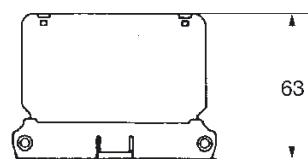

## Fixing holes

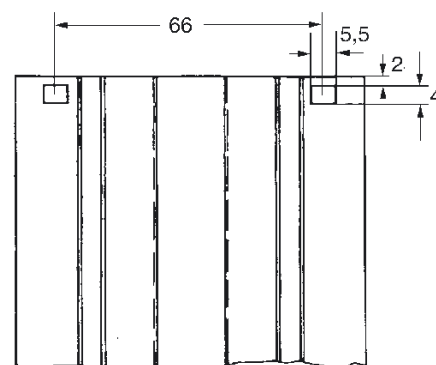

ADP 5 / ADP 6

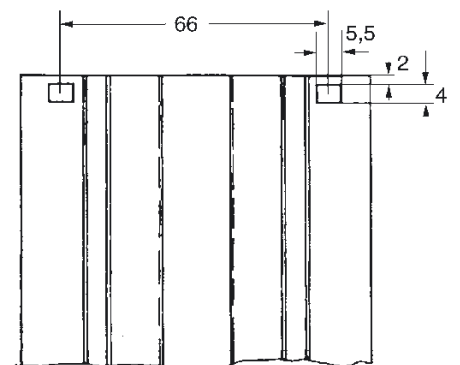

ADP 10 / ADP 11

# Housings

## Pluggable relay socket RSS 5MM

- Suitable for PCB mounting
- For miniature all-or-nothing relays type *Tyco* SNR, *NAIS* APE ...
- Mechanical interlock with eject lever

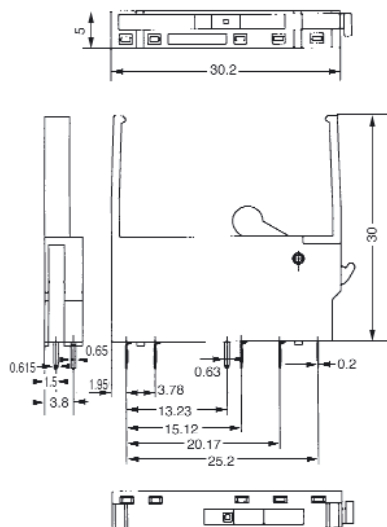

## Semi-wire relay socket OS 2 and OS 2/5

- Suitable for PCB mounting
- For solid state relays Type *Opto 22*, *Crouzet* ...
- Secured in socket by fixing screws integrated in the module

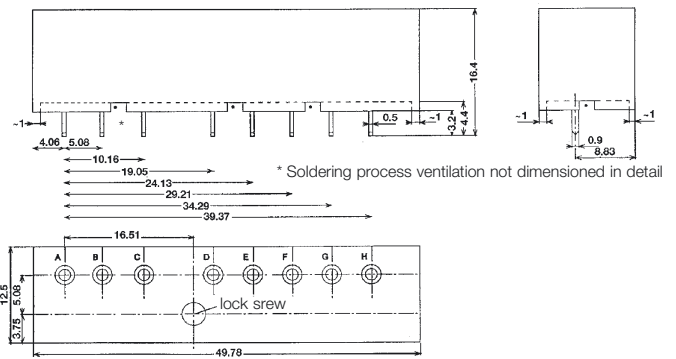
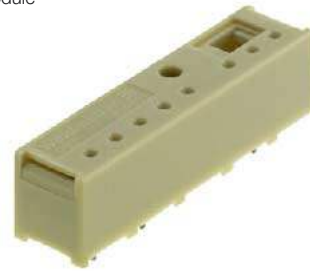

### Ordering data

Type	Cat. No.
RSS 5 MM	4056360000

### Technical data

Input voltage	250 V
Output voltage	250 V
Max. switching current	6 A
Rated current	5 A
Flammability class acc. to UL 94	V-2

### Insulation coordination acc. to EN 50178

Rated voltage	250 V
Rated impulse voltage	
Input circuit	4 kV (1.2/50 µs)
Output circuit	4 kV (1.2/50 µs)
Input < output	< 8 kV (1.2/50 µs)
Overvoltage category	III
Pollution severity	2

### Ambient conditions

Ambient temperature	- 25°C ... + 50°C
Storage temperature	- 40°C ... + 85°C

### Dimensions

Length / width / height	30,2 / 5 / 30 mm
Soldering pin	3.5 mm

### Ordering data

Type	Cat. No.
OS2	9455210000 <sup>1)</sup>
OS2/5	9457640000 <sup>2)</sup>

### Technical data

Input voltage	250 V
Output voltage	250 V
Rated current	5 A
Flammability class acc. to UL 94	V-2

### Insulation coordination acc. to EN 50178

Rated voltage	250 V
Rated impulse voltage	
Input circuit	4 kV (1.2/50 µs)
Output circuit	4 kV (1.2/50 µs)
Input < output	< 8 kV (1.2/50 µs)
Overvoltage category	III
Pollution severity	2

### Ambient conditions

Ambient temperature	- 25°C ... + 50°C
Storage temperature	- 40°C ... + 85°C

### Dimensions

Length / width / height	49,78 / 12,5 / 13,2 mm
Soldering pin	3,2 mm

<sup>1)</sup> equipped with with contact sockets B, C, F, H

<sup>2)</sup> equipped with with contact sockets A, B, C, F, H