

- SAW Filter for Digital Television
- Complies with Directive 2011/65/EU (RoHS)
- Moisture Sensitivity Level: 1

Characteristics:

Balance-to-Balanced Operation
Terminating Source/Load Impedance: ZS = 150 Ω

Maximum Rating

Rating	Value	Units
Input Power Level	0	dBm
DC Voltage on any Non-ground Terminal	3	V
Operating Temperature Range	-40 to +85	°C
Storage Temperature Range in Tape and Reel	-40 to +85	°C
Maximum Soldering Profile, 5 cycles/ 10 seconds maximum	265	°C

SF2169E

1790.48 MHz
SAW Filter

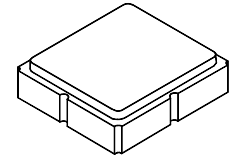

SM3030-8

Electrical Characteristics

Characteristic	Sym	Notes	Min	Typ	Max	Units
Center Frequency	f_c			1790.48		MHz
Maximum Insertion Loss, 1770.48 to 1810.48 MHz	IL_{MAX}			4.5	5.5	dB
1.5 dB Passband				61		MHz
Amplitude Ripple, 1770.48 to 1810.48 MHz				1.0	1.8	dB
Attenuation, Referenced to IL_{MAX}						
50 to 1708.42 MHz			40	45		dB
1872.54 to 1900 MHz			37	50		
1900 to 2000 MHz			44	48		
2000 to 6000 MHz			20	30		
Group Delay Ripple, 1770.48 to 1810.48 MHz				5	20	ns _{P-P}

Case Style	SM3030-8 3.0 x 3.0 mm Nominal Footprint
Lid Symbolization (Y=year, WW=week, S=shift) dot=pin 1 indicator	856, <u>YWWS</u>

 **CAUTION: Electrostatic Sensitive Device. Observe precautions for handling.**

NOTES:

1. The design, manufacturing process, and specifications of this device are subject to change.
2. US or International patents may apply.
3. RoHS compliant from the first date of manufacture.

Filter S_{11} , S_{22} and S_{21} Plots

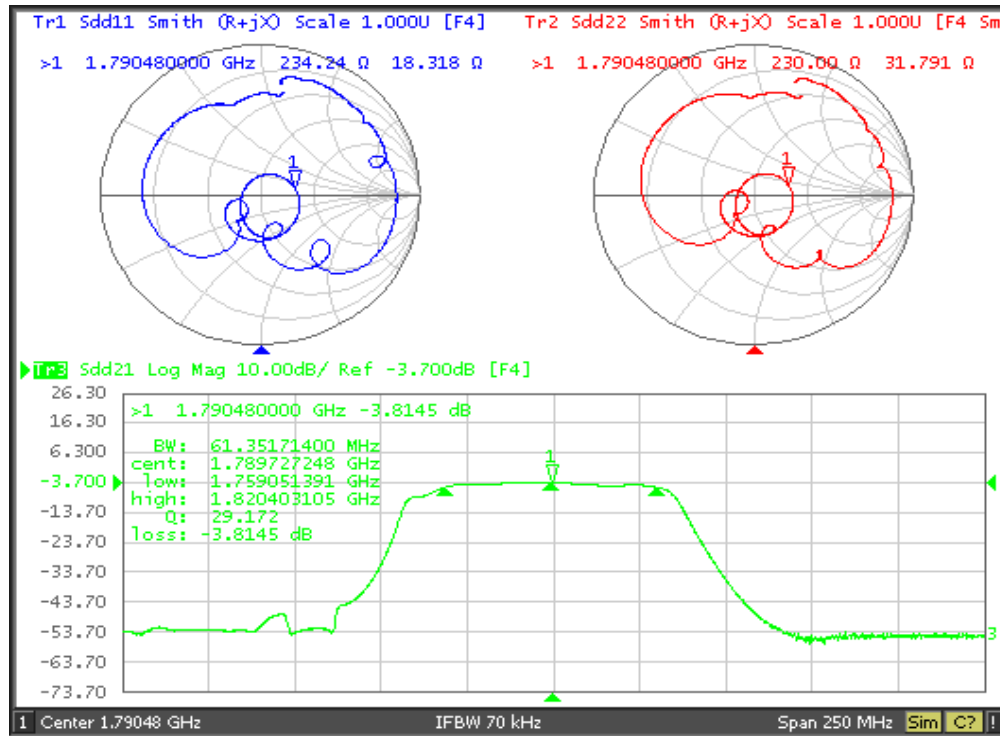

Filter Near-in Rejection

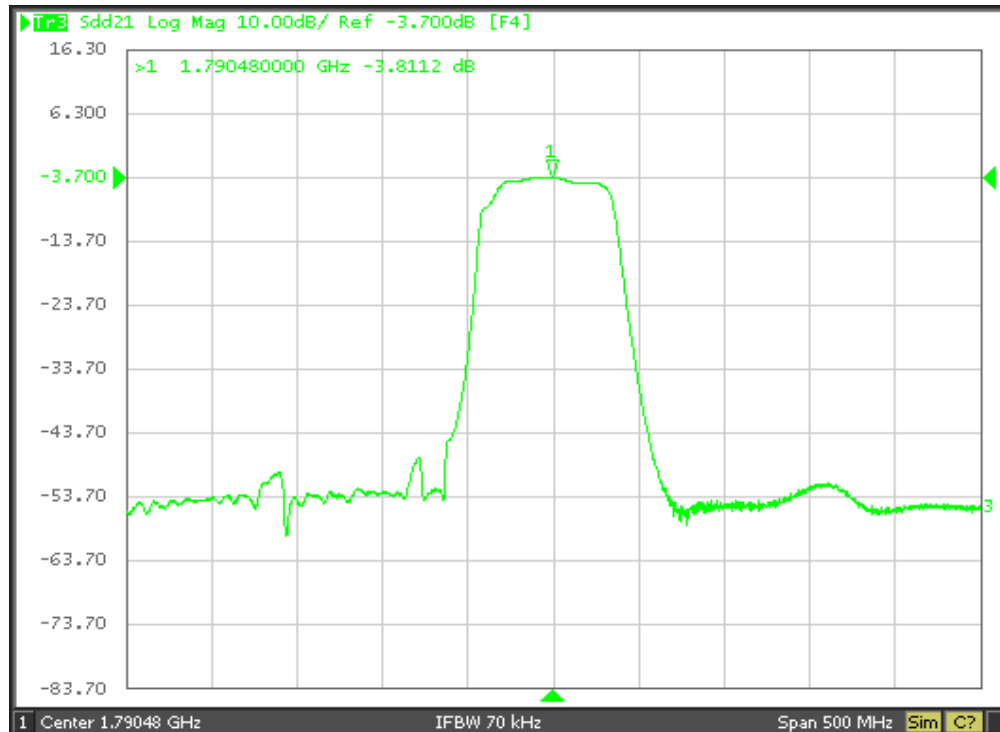

Filter Broadband Rejection

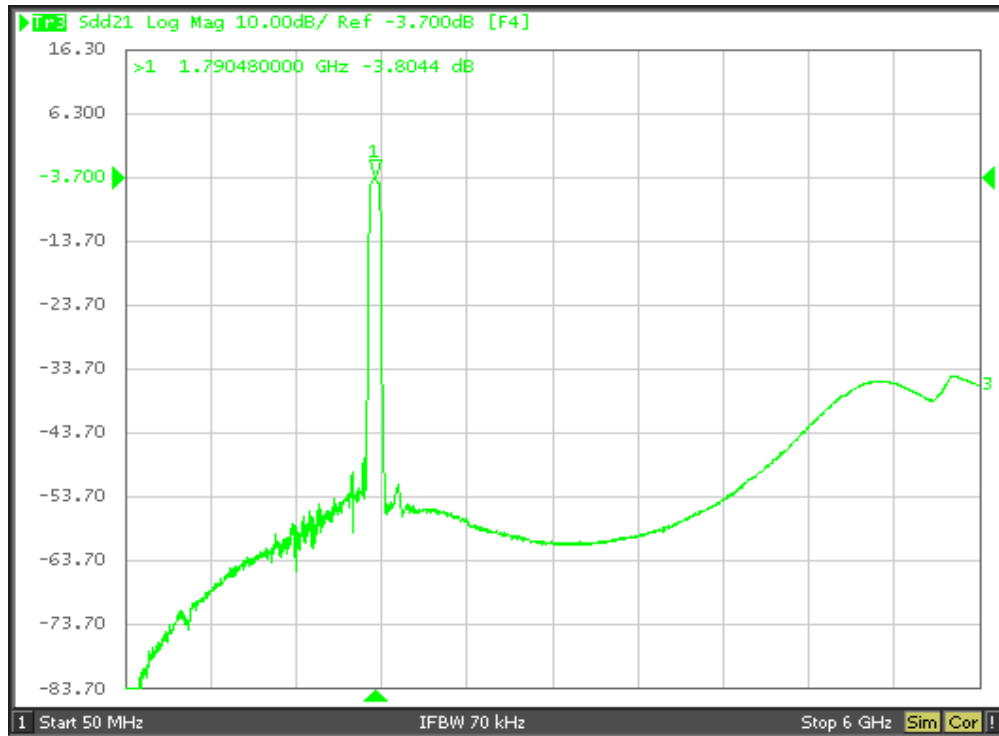

Filter Passband Amplitude and Group Delay Detail

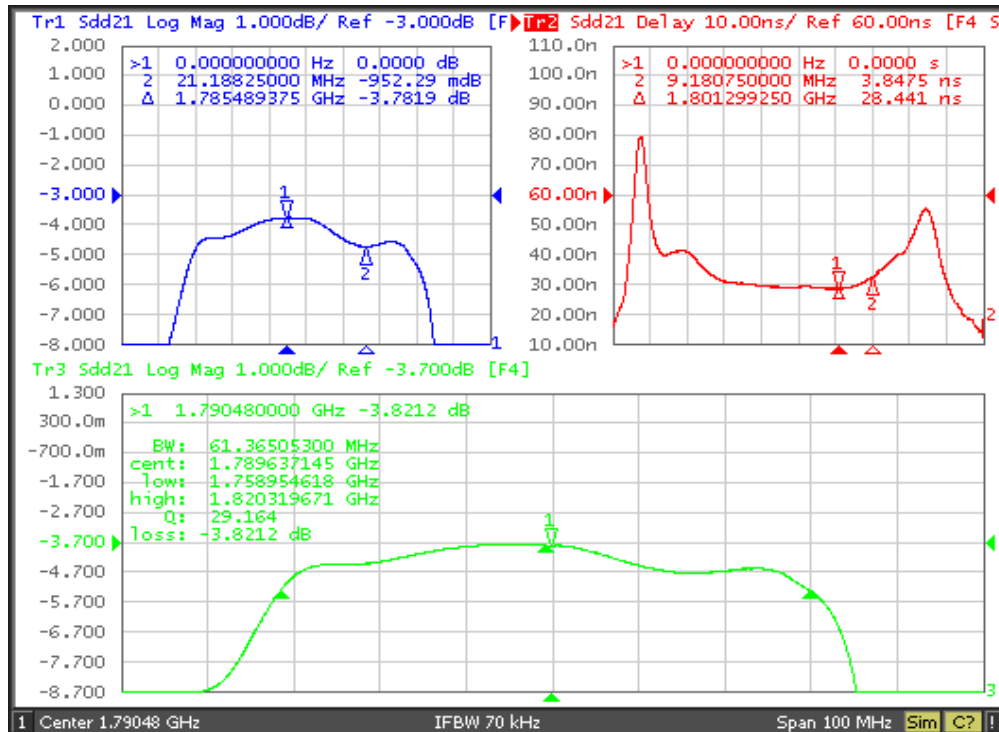

Tuning Network, 150 ohm Balanced Source/Load

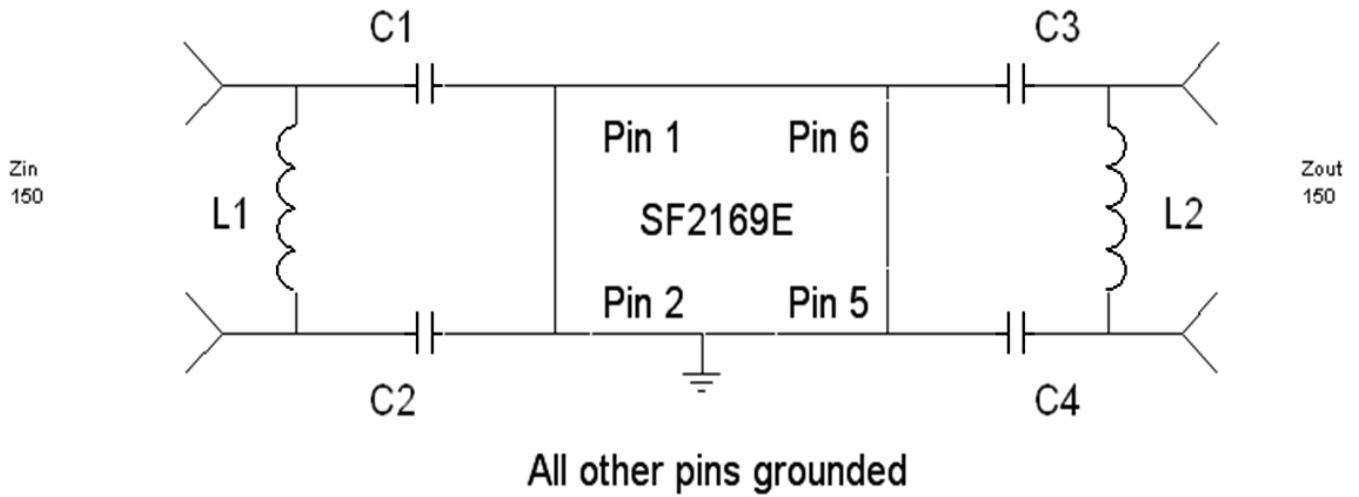

L1, L2 10 nH
C1, C2, C3, C4 10 pF

8-Terminal Ceramic Surface-Mount Case 3.0 X 3.0 mm Nominal Footprint

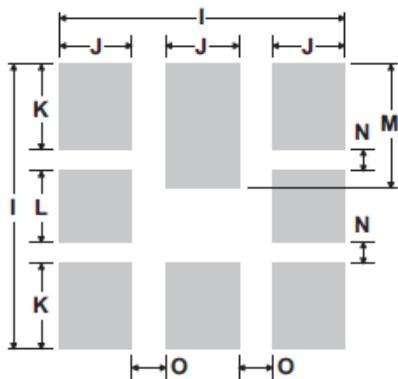
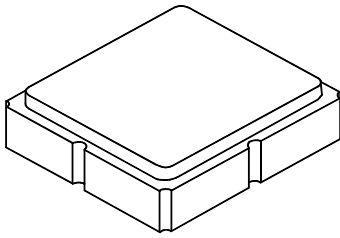

PCB Footprint Top View

Case and PCB Footprint Dimensions

Dimension	mm			Inches		
	Min	Nom	Max	Min	Nom	Max
A	2.87	3.0	3.13	0.113	0.118	0.123
B	2.87	3.0	3.13	0.113	0.118	0.123
C	1.14	1.27	1.40	0.045	0.050	0.055
D	0.79	0.92	1.05	0.031	0.036	0.041
E	0.62	0.75	0.88	0.024	0.029	0.034
F	0.47	0.60	0.73	0.018	0.024	0.029
G	0.47	0.60	0.73	0.018	0.024	0.029
H	1.07	1.20	1.33	0.042	0.047	0.052
I		3.19			0.126	
J		0.81			0.032	
K		0.96			0.038	
L		0.81			0.032	
M		1.39			0.055	
N		0.23			0.009	
O		0.38			0.015	

Case Materials

Materials	
Solder Pad Plating	0.3 to 1.0 μm Gold over 1.27 to 8.89 μm Nickel
Lid Plating	2.0 to 3.0 μm Nickel
Body	Al_2O_3 Ceramic

TOP VIEW

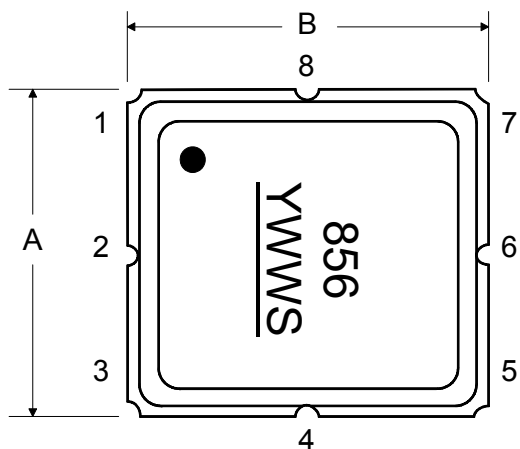

BOTTOM VIEW

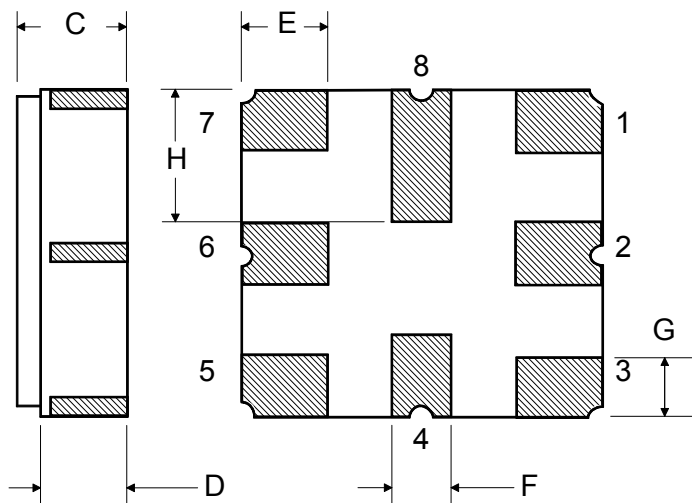

Tape and Reel Specifications

Tape and Reel Standard per ANSI/EIA-481

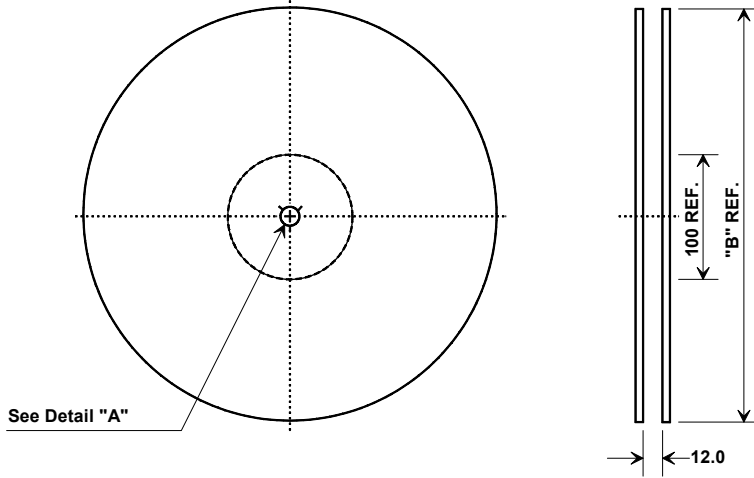

"B"		Quantity Per Reel
Inches	millimeters	
7	178	500
13	330	3000

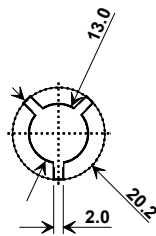

Carrier Tape Dimensions	
Ao	3.35 mm
Bo	3.35 mm
Ko	1.4 mm
Pitch	8.0 mm
W	12.0 mm

COMPONENT ORIENTATION and DIMENSIONS

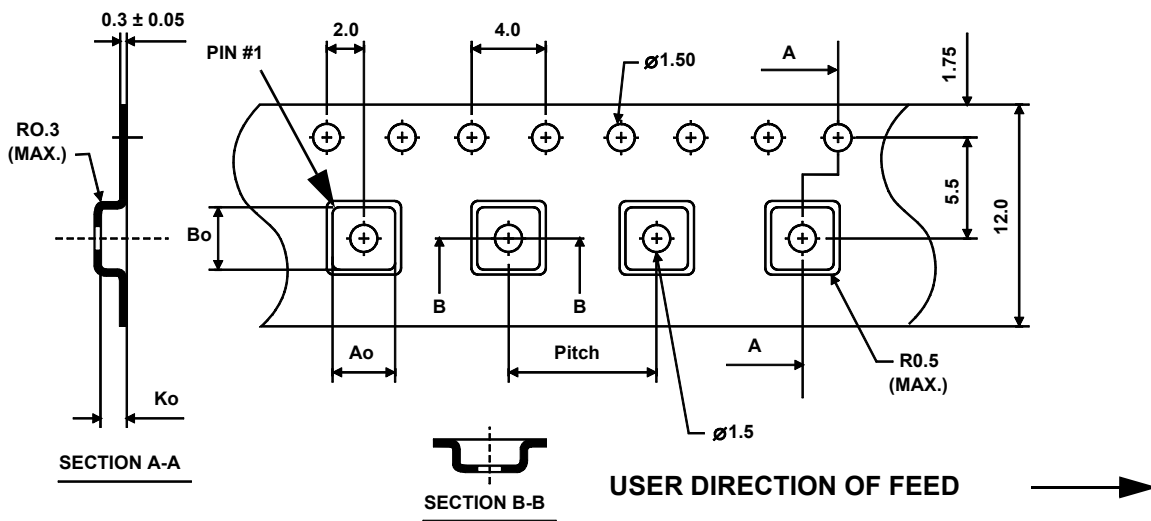

Recommended Reflow Profile

1. Preheating shall be fixed at 150~180°C for 60~90 seconds.
2. Ascending time to preheating temperature 150°C shall be 30 seconds min.
3. Heating shall be fixed at 220°C for 50~80 seconds and at 260°C +0/-5°C peak (10 seconds).
4. Time: 5 times maximum.

