

65 W USB-PD SMPS reference with XDP™ digital power XDPS21081

About this document

Scope and purpose

This document describes the 65 W 5/9/12/15 V 3 A or 20 V 3.25 A, 90 V AC ~ 265 V AC input off-line forced quasi-resonant (FQR) zero voltage switching (ZVS) flyback converter demo board using the Infineon digital FQR ZVS flyback controller XDP™ digital power XDPS21081 and MOSFETs [IPL60R185C7](#), [BSC0802LS](#) and [BSL606SN](#).

Intended audience

This document is intended for users of the XDP™ digital power XDPS21081 who wish to design a FQR ZVS flyback converter for high-density (HD) adapters in notebooks and other computer-related applications.

Table of contents

About this document	1
Table of contents	1
1 Abstract	3
2 Specifications of the demo board	4
3 Reference board	5
4 Features of XDPS21081	6
5 Circuit description	7
5.1 Introduction.....	7
6 Circuit diagram	8
7 PCB layout	9
8 Bill of materials	12
9 Transformer construction	16
9.1 Input CMC, L1.....	16
9.2 Input DMC, L2	16
9.3 FQR ZVS flyback transformer	17
10 Measurement results	19
10.1 Efficiency.....	19
10.2 Standby power	24
10.3 Output ripple – steady-state operation.....	24
10.4 Regulation under different loads.....	26
10.5 Dynamic load steps	27
10.6 Loop stability	29
10.7 Measurement results.....	30
10.8 Conducted emissions (EN 55022 class B)	32
10.9 Operational waveforms	33
10.9.1 Main MOSFET switching waveform at low-/high-line	33
10.9.2 Burst mode (BM) waveform	33
10.10 V _{CC} charge time	34



Abstract

10.11 Brown-in/brown-out 34

10.12 V_{out} OVP protection 35

10.13 Overload protection 35

10.14 Output short-circuit protection 36

10.15 Current sense (CS) resistor short protection..... 36

10.16 V_{CC} OVP 37

11 References 38

Revision history..... 39

Abstract

1 Abstract

This is an application note for the demo board “REF_XDPS21081_65W”.

The XDP™ digital power XDPS21081 65 W FQR ZVS demo board from Infineon shows the best-in-class power density achievable with the new FFR principle for single-stage flyback with reasonable cost added.

The demo board takes universal AC input and converts it to the typical 5 to 20 V DC output accepted by most modern laptops and cell phones. With very modest dimensions, a best-in-class power density for such a laptop adapter of 20 W/in³ is achieved. The resonant switching transitions are exploited to virtually eliminate main MOSFET switching losses at the required frequency band. This approach enables the high switching frequency necessary to allow smaller components (e.g., transformers) while still maintaining (or even improving) the efficiency necessary to manage heat dissipation in a very small form factor. For easy SR IC selection, the XDP™ digital power XDPS21081 is implemented with guaranteed QR or discontinuous conduction mode (DCM) operation under all conditions. The XDP™ digital power XDPS21081 also implements frequency reduction mode (FRM), and burst mode (BM) to maximize efficiency at medium to light load. In all, the overall efficiency can be pushed to more than 90 percent in all load and line ranges, and peak efficiency achieve above 93 percent.

Although not formally certified, the 65 W FQR ZVS demo board conforms to most standard regulatory compliance requirements such as conducted EMI, isolation requirements, etc.

The XDP™ digital power XDPS21081 also has various configuration features to exploit the full function of an adapter such as propagation delay compensation for maximum power control, adaptive current limit for variable output voltage, and configurable line voltage for transition between QR and FQR ZVS modes. There are also various protection features (e.g., brown-in/brown-out, CS pin short, V_{CC} overvoltage protection (OVP), V_{out} OVP, overcurrent protection (OCP), overload protection (OLP), overtemperature protection (OTP), latch enable, etc.).

Specifications of the demo board**2 Specifications of the demo board****Table 1 Specifications of DEMO-XDPS21081-65W**

Input voltage	90 V AC ~ 265 V AC
Input frequency	50/60 Hz
Output load	Full load: 20 V at 3.25 A, 5/9/12/15 V at 3 A
Efficiency	EC COCV5 Tier 2 and DOELV6
Standby power (no load)	Less than 65 mW
Controller IC	XDPS21081
Main/SR/safety MOSFET	IPL60R185C7/BSC0802LS/BSL606SN/BSZ0905PNS
Form factor (L x W x H)	60 x 28 x 25 mm = 47.6 cm ³
Power density (PCBA)	25 W/in ³

Reference board

3 Reference board

This document contains the list of features, power supply specifications, schematics, bill of materials (BOM) and the transformer construction documentation. Typical operating characteristics such as performance curves and oscilloscope waveforms are shown at the end of the document.



Figure 1 REF_XDPS21081_65W FQR ZVS flyback converter (top view)

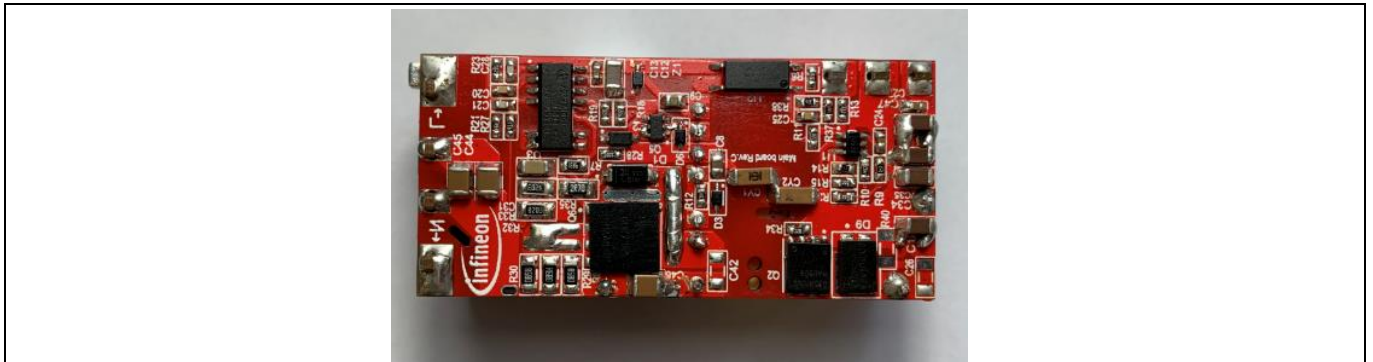

Figure 2 REF_XDPS21081_65W FQR ZVS flyback converter (bottom view)

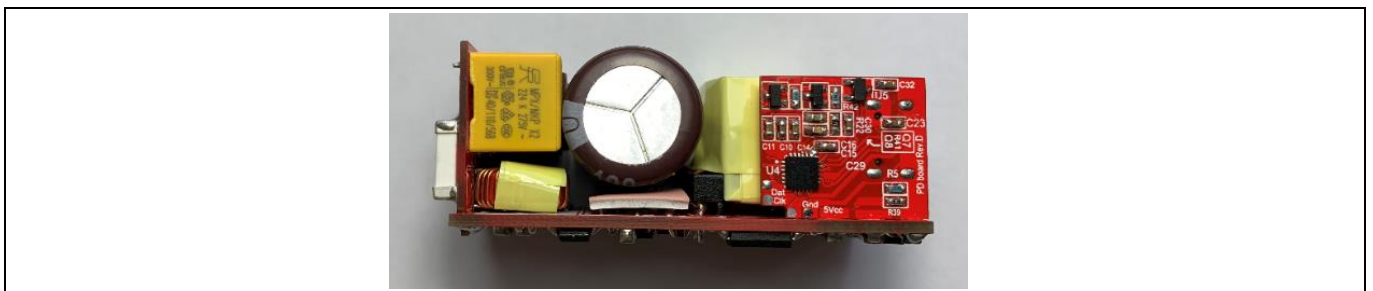

Figure 3 REF_XDPS21081_65W FQR ZVS flyback converter (side view)

Features of XDPS21081

4 Features of XDPS21081

Table 2 Features of XDPS21081

Multimode operation with ABM, DCM, QR, FQR mode
Low-line QR, high-line FQR ZVS for optimal efficiency
Configurable line voltage for transition threshold between QR and FQR ZVS mode
Adaptive V_{CS} offset compensation for current limit
Brown-in and brown-out detection via integrated HV start-up cell
Built-in soft-start
Built-in protection modes

Circuit diagram

6 Circuit diagram

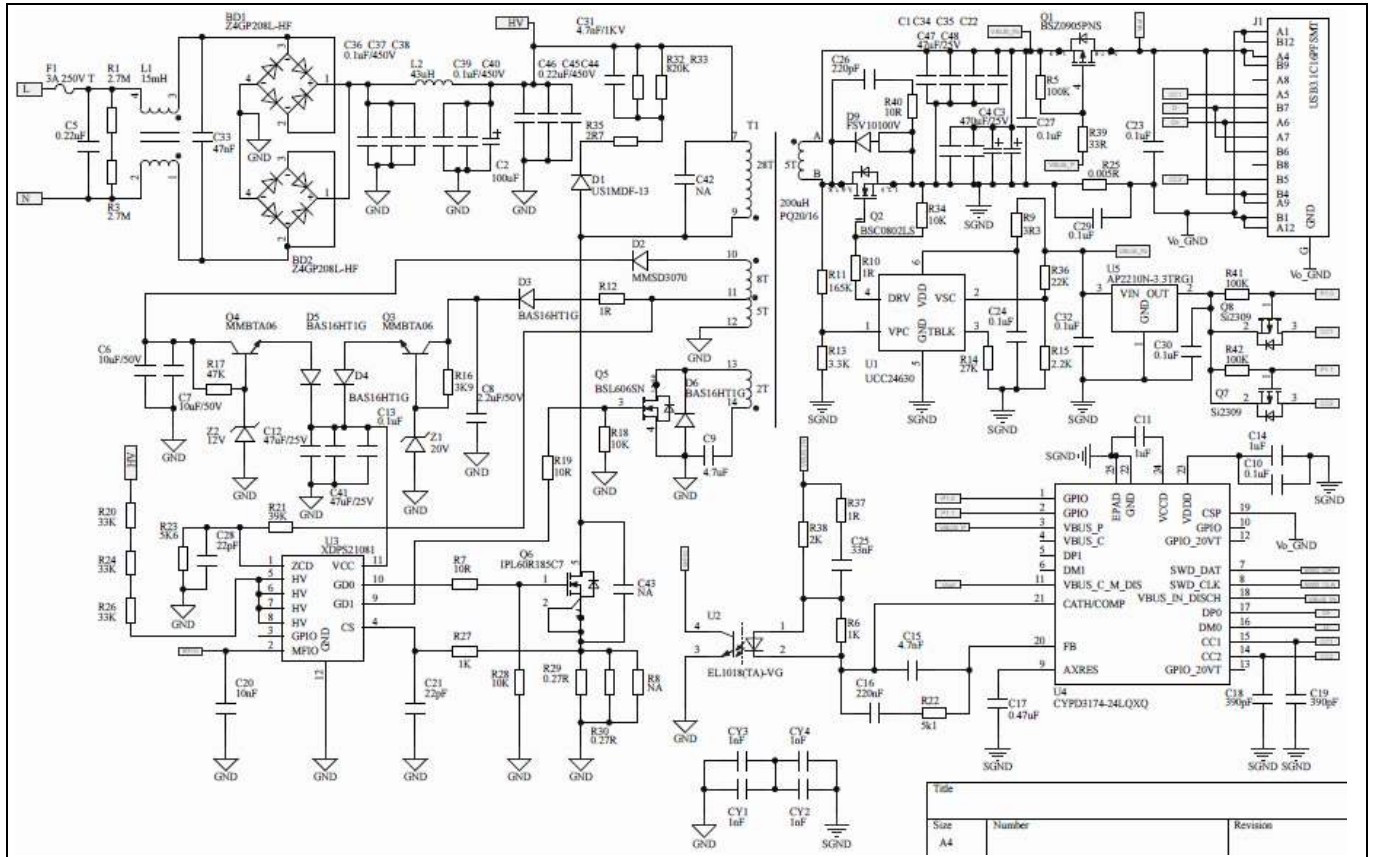

Figure 5 Schematics of 65 W FQR ZVS flyback

PCB layout

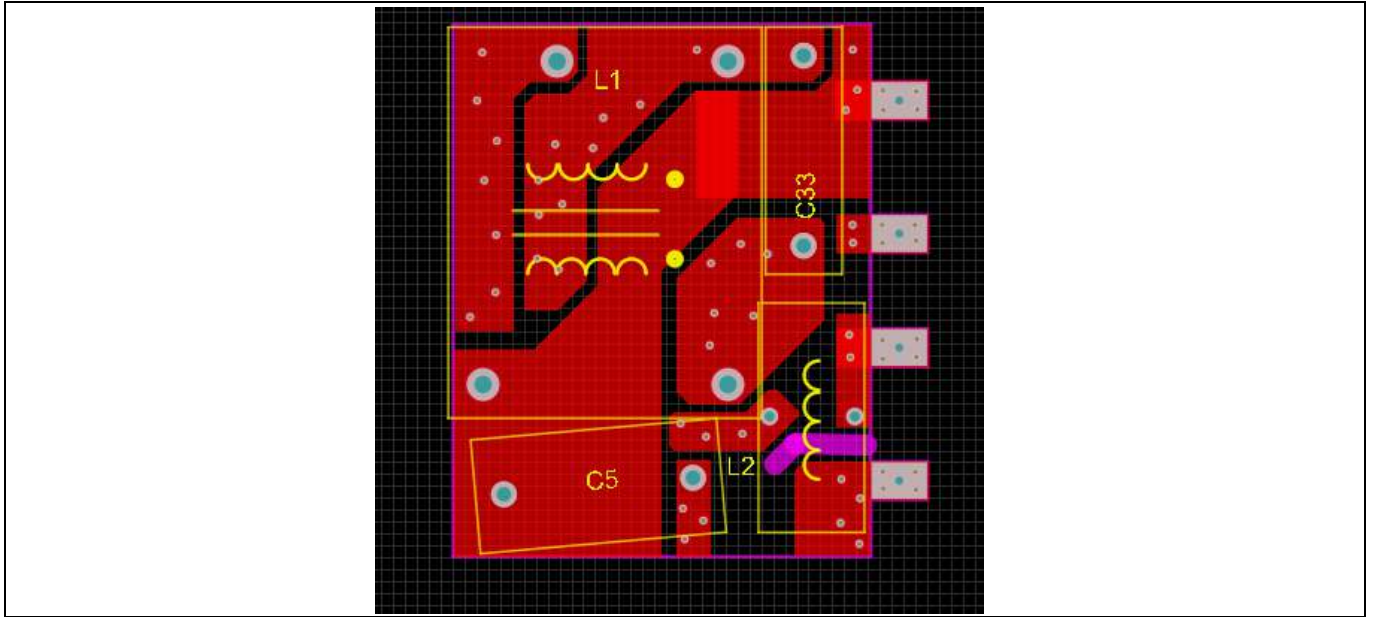

Figure 8 Top side (EMI board)

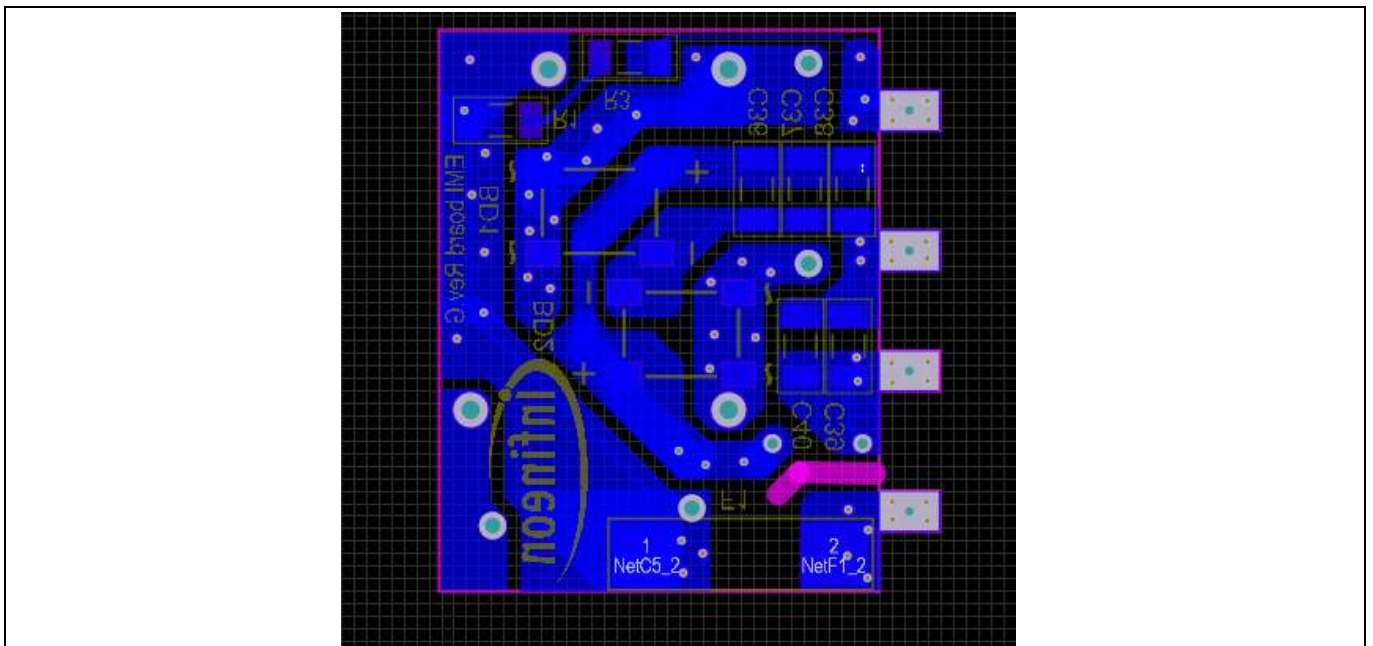

Figure 9 Bottom side (EMI board)

Bill of materials

8 Bill of materials

Table 3 BOM

65 W main board BOM					
Designator	Value	Description	Manufacturer part no.	Manufacturer	Package
C1, C12, C22, C34, C35, C41, C47, C48	47 μ F/25 V	47 μ F (476) \pm 20 percent 25 V	GRM31CR61E476ME 44L	Murata	1206
C2	100 μ F	100 μ F 400 V \pm 20 percent 105°C 18 x 25 mm	EKMG401ELL101MM 25S	NCC	18 x 25 mm
C3, C4	470 μ F/25 V	470 μ F 25 V \pm 20 percent 105°C 6.3 x 14 mm	SPZ1EM471E14O00R AXXX	AiSHi	6.3 x 14 mm
C6, C7	10 μ F/50 V	10 μ F (106) \pm 10 percent 50 V	CL31B106KBHNNNE	Samsung	1206
C8	2.2 μ F/50 V	2.2 μ F (225) 0805 \pm 10 percent 50 V X5R	CL21A225KB9LNNC	Samsung	0805
C9	4.7 μ F	4.7 μ F (475) 0805 \pm 10 percent 25 V X7R	CL21B475KAFNNNE	Samsung	0805
C13, C24, C27	0.1 μ F	100 nF (104) 0603 \pm 10 percent 50 V X7R	CC0603KRX7R9BB10 4	Yageo	0603
C20	10 nF	10 nF	General	General	0603
C21, C28	22 pF	22 pF	General	General	0603
C25	33 nF	33 nF	General	General	0603
C26	220 pF	220 pF	General	General	1206
C31	4.7 nF/1 kV	4.7 nF (472) 1206 \pm 10 percent 1 kV X7R	CC1206KKX7RCBB47 2	Yageo	1206
C44, C45, C46	0.22 μ F/450 V	220 nF (224) \pm 10 percent 450 V	C3225X7T2W224KT0 00N	TDK	1210
CY1, CY2, CY3, CY4	1 nF	1 nF (102) \pm 10 percent 250 V AC X1/Y2	SCC1808X102K502T	HEC	1808
D1	US1MDF-13	1 A 1 kV 75 ns	US1MDF-13	Diodes	D-FLAT
D2	MMSD3070	0.2 A 200 V 50 ns	MMSD3070	ON Semiconductor	SOD-123
D3, D4, D5, D6	BAS16HT1G	6 ns 85 V 0.2 A 1.25 V	BAS16HT1G	ON Semiconductor	SOD-323
D9	FSV10100V	23 ns 100 V 10 A 0.67 V	FSV10100V	ON Semiconductor	TO-277
Q2	BSC0802LS	N-channel 100 V 3.5 m Ω MOSFET SuperSO8	BSC0802LS	Infineon	SuperSO8

Bill of materials

65 W main board BOM

Q3, Q4	MMBTA06	NPN transistor 80 V 0.5 A SOT-23	MMBTA06LT1G	ON Semiconduct or	SOT-23
Q5	BSL606SN	N-MOSFET 60 V 4.5 A PG- TSOP-6	BSL606SN	Infineon	PG- TSOP-6
Q6	IPL60R185C 7	N-MOSFET 600 V 21A ThinPAK 8 x 8	IPL60R185C7	Infineon	ThinPAK 8 x 8
R6, R27	1 K	1 K	General	General	0603
R7	10 R	10 R	General	General	0805
R29, R30	0.27 R	0.27 R	General	General	1206
R9	3R3	3R3	General	General	0603
R10, R12, R37	1 R	1 R	General	General	0603
R11	165 K	165 K	General	General	0603
R13	3.3 K	3.3 K	General	General	0603
R14	27 K	27 K	General	General	0603
R15	2.2 K	2.2 K	General	General	0603
R16	3K9	3K9	General	General	0603
R17	47 K	47 K	General	General	0805
R18, R28, R34	10 K	10 K	General	General	0603
R19	10 R	10 R	General	General	0603
R20, R24, R26	33 K	33 K	General	General	1206
R21	39 K	39 K	General	General	0603
R23	5K6	5K6	General	General	0603
R32, R33	820 K	820 K	General	General	1206
R35	2R7	2R7	General	General	1206
R36	22 K	22 K	General	General	0603
R38	2 K	2 K	General	General	0603
R40	10 R	10 R	General	General	1206
T1	PQ20/16	PQ20/16 3C95 200 μ H +5 percent	750344782	Würth Elektronik	PQ20/16

Bill of materials

65 W main board BOM

U1	UCC24630	SR IC regulated flyback controller	UCC24630DBVR	Texas Instruments	SOT-23-6
U2	EL1018(TA)-VG	EL1018(TA)-VG, SOP-4_P2.54	EL1018(TA)-VG	Everlight	SOP 4
U3	XDP21081	AC-DC PWM controller	XDP21081	Infineon	PG-DSO-12-20
Z1	20 V	SOD-323 0.3 W 20 V	MM3Z20VT1G	ON Semiconductor	SOD-323
Z2	12 V	SOD-123 0.5 W 12 V	MMSZ12T1G	ON Semiconductor	SOD-123

65 W EMI board BOM

Designator	Value	Description	Manufacturer part no.	Manufacturer	Package
BD1, BD2	Z4GP208L-HF	2 A 800 V ABS (Z4)	Z4GP208L-HF	Comchip	ABS (Z4)
C5	0.22 μ F	220 nF (224) 13.0 x 6 x 12/P = 10 \pm 10 percent 275 V	MP2224KGC3XLX	SRD	P10 13 x 6 x 12 mm
C33	47 nF	X2 47 nF \pm 10 percent 305 V AC	B32921C3473M189	Epcos/TDK	P10
C36, C37, C38, C39, C40	0.1 μ F/450 V	100 nF (104) \pm 10 percent 450 V	C1206X104K451T	HEC	1206
F1	3 A 250 V T	0443003.DR 3 A 250 V T	0443003.DR	Littelfuse	SMT 10 x 3 x 3 mm
L1	10 mH	R DC =160 m Ω 10 mH SQ1515	N/A	N/A	SQ1515
L2	43 μ H	7447034 43 μ H 0.06 Ω 13 x 6.5 P = 4.5 mm	7447034	Würth Elektronik	12 x 5.5 mm
R1, R3	2.7 M	2.7 M 1206	General	General	1206

Bill of materials

PD board BOM

Designator	Value	Description	Manufacturer part no.	Manufacturer	Package
C10, C23, C29, C30, C32	0.1 μ F	100 nF (104) 0603 \pm 10 percent 50 V X7R	CC0603KRX7R9BB10 4	Yageo	0603
C11, C14	1 μ F	1 μ F (105) 0603 \pm 10 percent 25 V X7R	CL10B105KA8NNNC	Samsung	0603
C15	4.7 nF	4.7 nF	General	General	0603
C16	220 nF	220 nF	General	General	0603
C17	0.47 μ F	0.47 μ F	General	General	0603
C18, C19	390 pF	390 pF	General	General	0603
J1	USB3.1C16PF SMT	USB connector/ USB 3.1 C 16PF SMT single row, Rev.2.0, female	USB3.1C16PFSMT single row, Rev.2.0, female	Jingtuojin	SMT
Q1	BSZ0905PNS	MOSFET P-channel 30 V 13.5 A 8-pin TS _{DS(on)}	BSZ086P03NS3E G	Infineon	PG-TSDSON-8
Q7, Q8	Si2309	MOSFET P-channel 60 V 1.6 A SOT-23	SI2309CDS-T1-GE3	Vishay	SOT-23
R5, R41, R42	100 K	100 K	General	General	0603
R22	5k1	5k1	General	General	0603
R25	0.005 R	0.005 R	General	General	1206
R39	33 R	33 R	General	General	0603
U4	CYPD3174-24LQXQ	PD IC QFN24	CYPD3174-24LQXQ	Cypress	QFN24
U5	AP2210N-3.3TRG1	LDO.VREG POS 3.3 V 0.3 A SOT-23-3	AP2210N-3.3TRG1	Diodes	SOT-23-3

Transformer construction

9 Transformer construction

9.1 Input CMC, L1

Inductance: 10.5 mH at 10 kHz

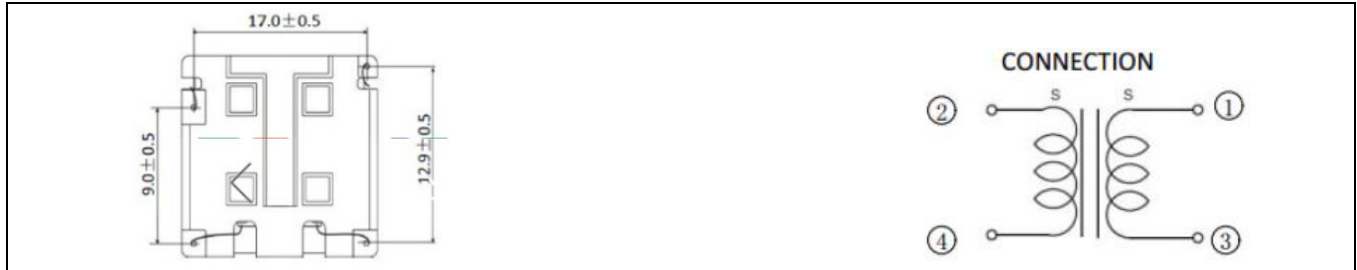

Figure 12 CM choke (bottom view) and electrical diagram

9.2 Input DMC, L2

Inductance: 43 μH at 10 kHz, R DC 60 mΩ



Figure 13 DM choke (side view) and electrical diagram

Transformer construction

9.3 FQR ZVS flyback transformer

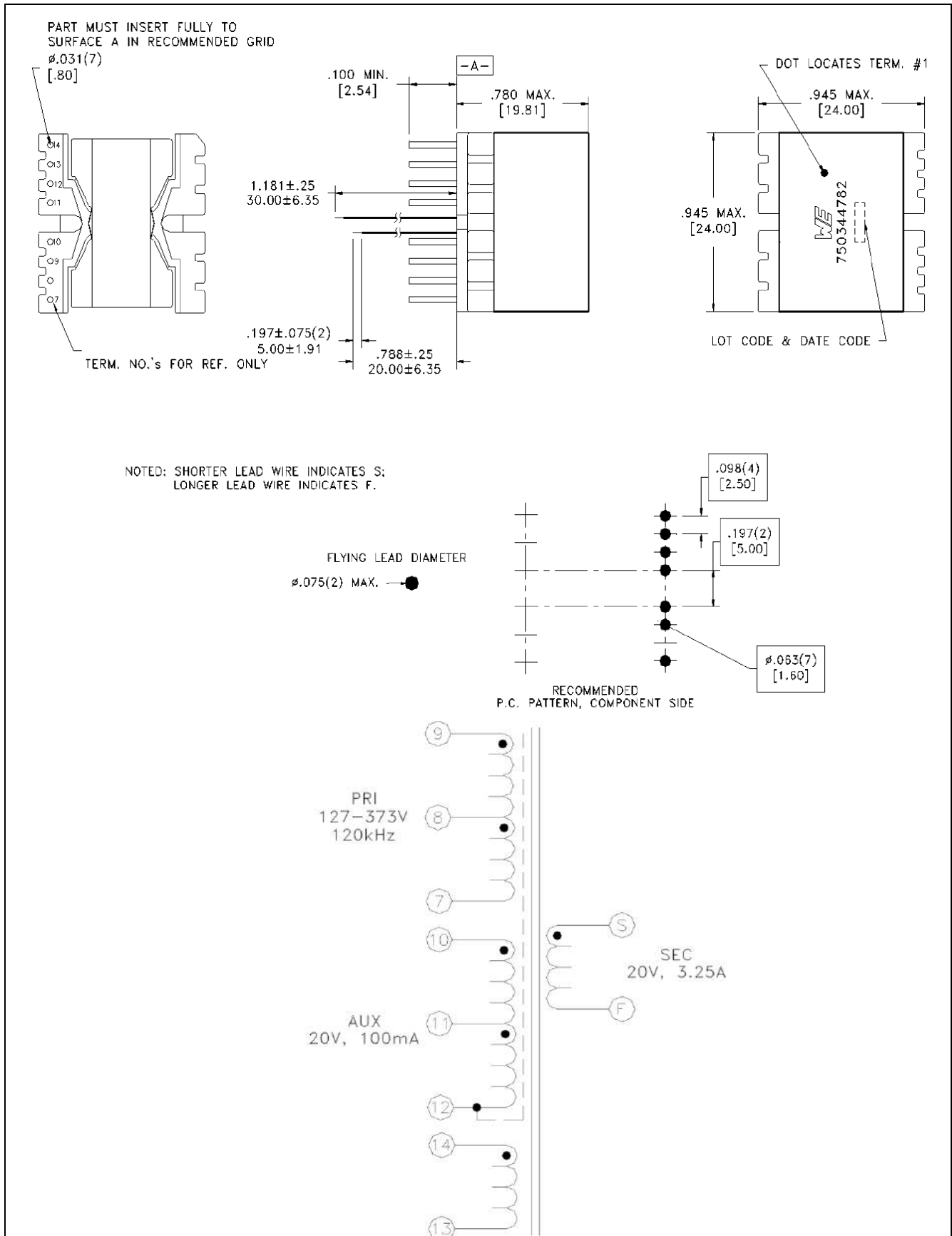

Figure 14 Flyback transformer

Transformer construction

Table 4 Flyback transformer winding characteristics



ELECTRICAL SPECIFICATIONS @ 25° C unless otherwise noted:

PARAMETER		TEST CONDITIONS	VALUE
D.C. RESISTANCE	9-7	@20°C	0.165 ohms max.
D.C. RESISTANCE	10-12	@20°C	0.790 ohms max.
D.C. RESISTANCE	14-13	@20°C	0.050 ohms max.
D.C. RESISTANCE	S-F	@20°C	0.015 ohms max.
INDUCTANCE	9-7	1kHz, 1V, Ls	200.00µH ±5%
LEAKAGE INDUCTANCE	9-7	tie(S+F), 1kHz, 1V, Ls	15µH max.
DIELECTRIC	7-S	tie(9+10+11+12+13+14), 4000VAC, 1 second	3200VAC, 1 minute
TURNS RATIO		(9-7):(S-F)	5.6:1
TURNS RATIO		(9-7):(10-11)	3.5:1
TURNS RATIO		(9-7):(11-12)	5.6:1
TURNS RATIO		(9-7):(14-13)	14:1
INSULATION RESISTANCE	9-S	500 Vdc, 60 seconds	100MOhms min.

Measurement results

10 Measurement results

10.1 Efficiency

Efficiency was measured with the unit outside of the enclosure and by sensing the output voltage directly on the PCB terminals. The input AC voltage was fed to the device under test (DUT) by a Chroma AC voltage source. An electronic load was used in constant current (CC) mode.

The efficiency of 10 percent, 25 percent, 50 percent, 75 percent and 100 percent load is measured at 115 V AC and 230 V AC. The average efficiency of 25 percent, 50 percent, 75 percent and 100 percent is calculated.

Measurement results

Table 5 Measured efficiency over line and load range at PCB end

115 V AC						230 V AC					
5 V		P _{in}	P _{out}	V _{out}	Eff.	5 V		P _{in}	P _{out}	V _{out}	Eff.
10%	0.3	1.83	1.51	5.02	82.30%	10%	0.3	1.93	1.51	5.02	78.03%
25%	0.75	4.22	3.77	5.02	89.22%	25%	0.75	4.32	3.77	5.02	87.15%
50%	1.5	8.26	7.53	5.02	91.16%	50%	1.5	8.35	7.53	5.02	90.18%
75%	2.25	12.35	11.30	5.02	91.46%	75%	2.25	12.45	11.30	5.02	90.72%
100%	3	16.42	15.06	5.02	91.72%	100%	3	16.54	15.06	5.02	91.05%
	Avg.				90.89%		Avg.				89.78%

9 V		P _{in}	P _{out}	V _{out}	Eff.	9 V		P _{in}	P _{out}	V _{out}	Eff.
10%	0.3	3.19	2.70	9	84.64%	10%	0.3	3.32	2.70	9	81.33%
25%	0.75	7.48	6.75	9	90.24%	25%	0.75	7.52	6.75	9	89.76%
50%	1.5	14.75	13.50	9	91.53%	50%	1.5	14.78	13.50	9	91.34%
75%	2.25	22.05	20.25	9	91.84%	75%	2.25	22.05	20.25	9	91.84%
100%	3	29.27	27.00	9	92.24%	100%	3	29.19	27.00	9	92.50%
	Avg.				91.46%		Avg.				91.36%

12 V		P _{in}	P _{out}	V _{out}	Eff.	12 V		P _{in}	P _{out}	V _{out}	Eff.
10%	0.3	4.22	3.59	11.96	85.02%	10%	0.3	4.32	3.59	11.96	83.06%
25%	0.75	9.94	8.97	11.96	90.24%	25%	0.75	10.04	8.97	11.96	89.34%
50%	1.5	19.52	17.94	11.96	91.91%	50%	1.5	19.62	17.94	11.96	91.44%
75%	2.25	29.14	26.91	11.96	92.35%	75%	2.25	29.16	26.91	11.96	92.28%
100%	3	38.74	35.88	11.96	92.62%	100%	3	38.49	35.88	11.96	93.22%
	Avg.				91.78%		Avg.				91.57%

15 V		P _{in}	P _{out}	V _{out}	Eff.	15 V		P _{in}	P _{out}	V _{out}	Eff.
10%	0.3	5.11	4.49	14.95	87.77%	10%	0.3	5.17	4.49	14.95	86.75%
25%	0.75	12.27	11.21	14.95	91.38%	25%	0.75	12.31	11.21	14.95	91.08%
50%	1.5	24.35	22.43	14.95	92.09%	50%	1.5	24.33	22.43	14.95	92.17%
75%	2.25	36.46	33.64	14.95	92.26%	75%	2.25	36.22	33.64	14.95	92.87%
100%	3	48.56	44.88	14.96	92.42%	100%	3	48.02	44.88	14.96	93.46%
	Avg.				92.04%		Avg.				92.40%

20 V		P _{in}	P _{out}	V _{out}	Eff.	20 V		P _{in}	P _{out}	V _{out}	Eff.
10%	0.325	7.35	6.48	19.93	88.13%	10%	0.325	7.39	6.48	19.93	87.65%
25%	0.8125	17.79	16.19	19.93	91.02%	25%	0.8125	17.77	16.19	19.93	91.13%
50%	1.625	35.27	32.40	19.94	91.87%	50%	1.625	35.03	32.40	19.94	92.50%
75%	2.4375	52.78	48.60	19.94	92.09%	75%	2.4375	52.12	48.60	19.94	93.25%
100%	3.25	70.392	64.81	19.94	92.06%	100%	3.25	69.32	64.81	19.94	93.49%
	Avg.				91.76%		Avg.				92.59%

Measurement results

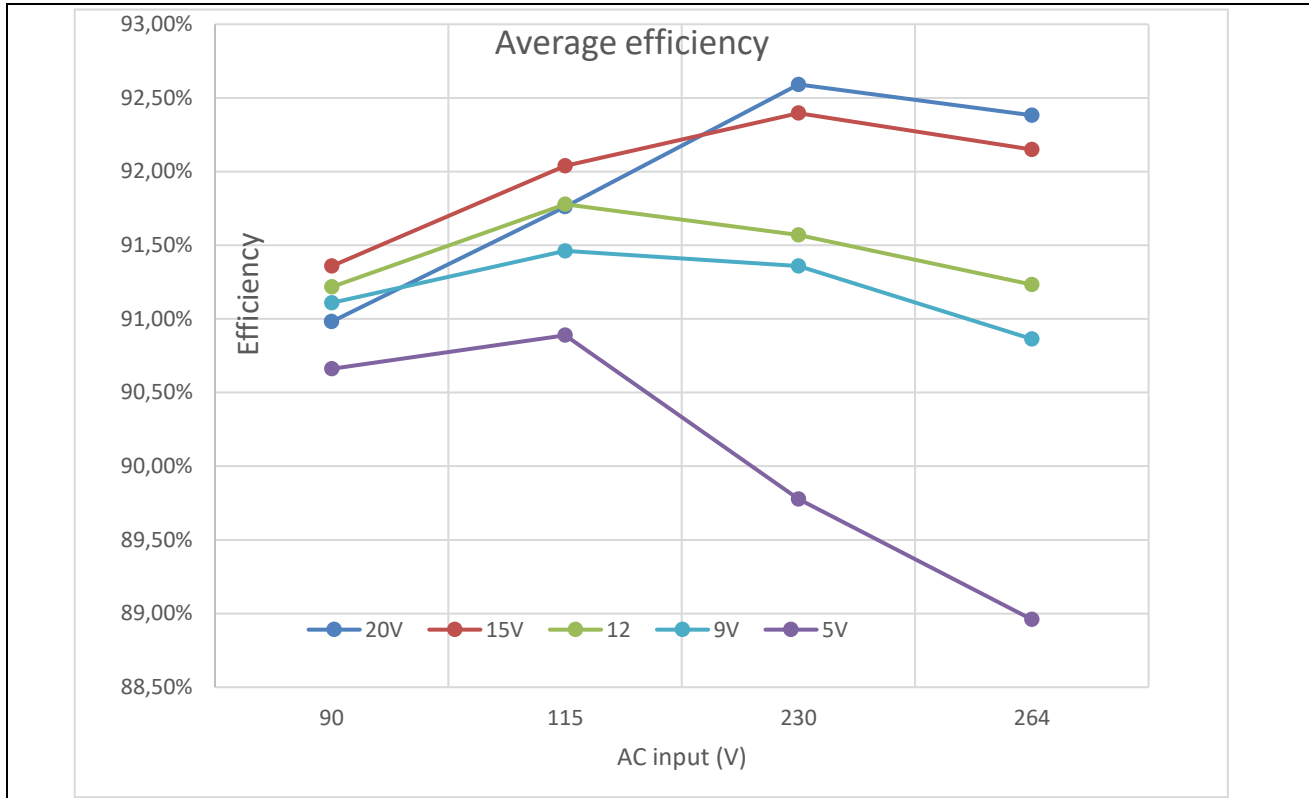

Figure 15 Average efficiency curves

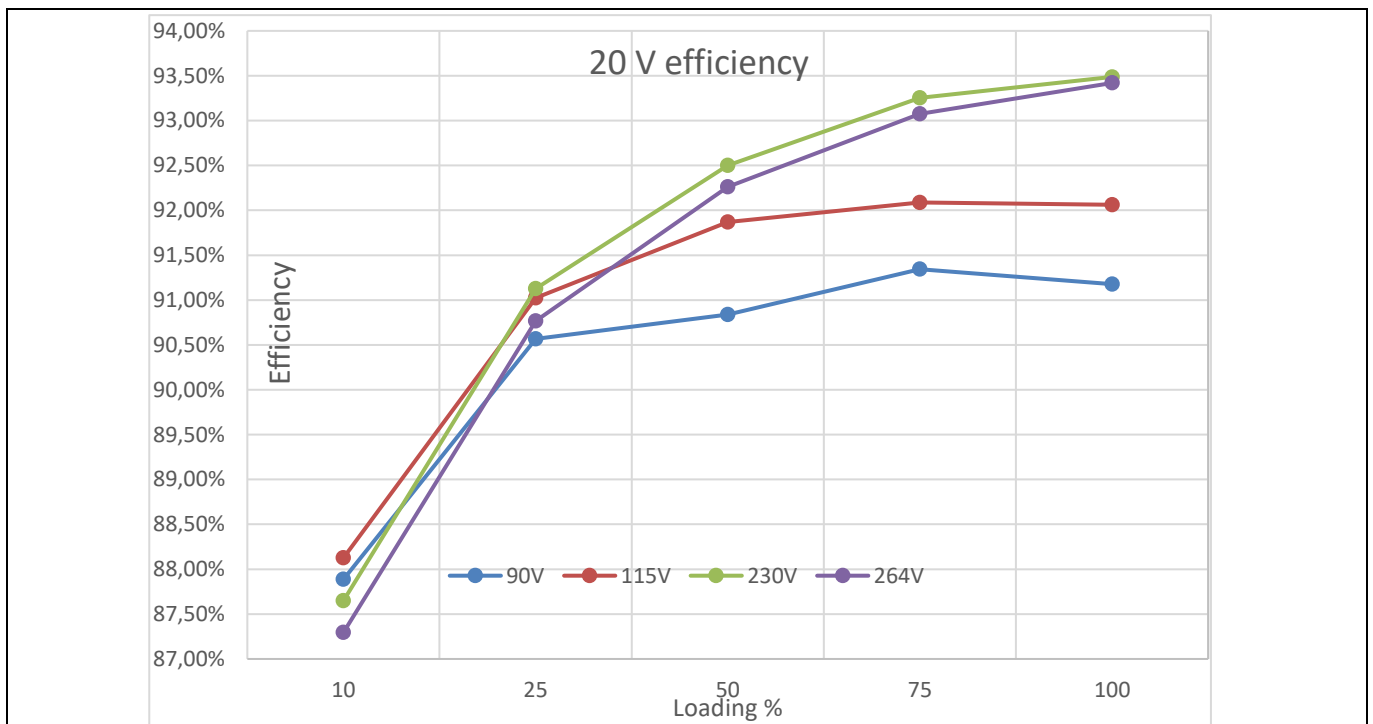

Figure 16 20 V output efficiency curves

Measurement results

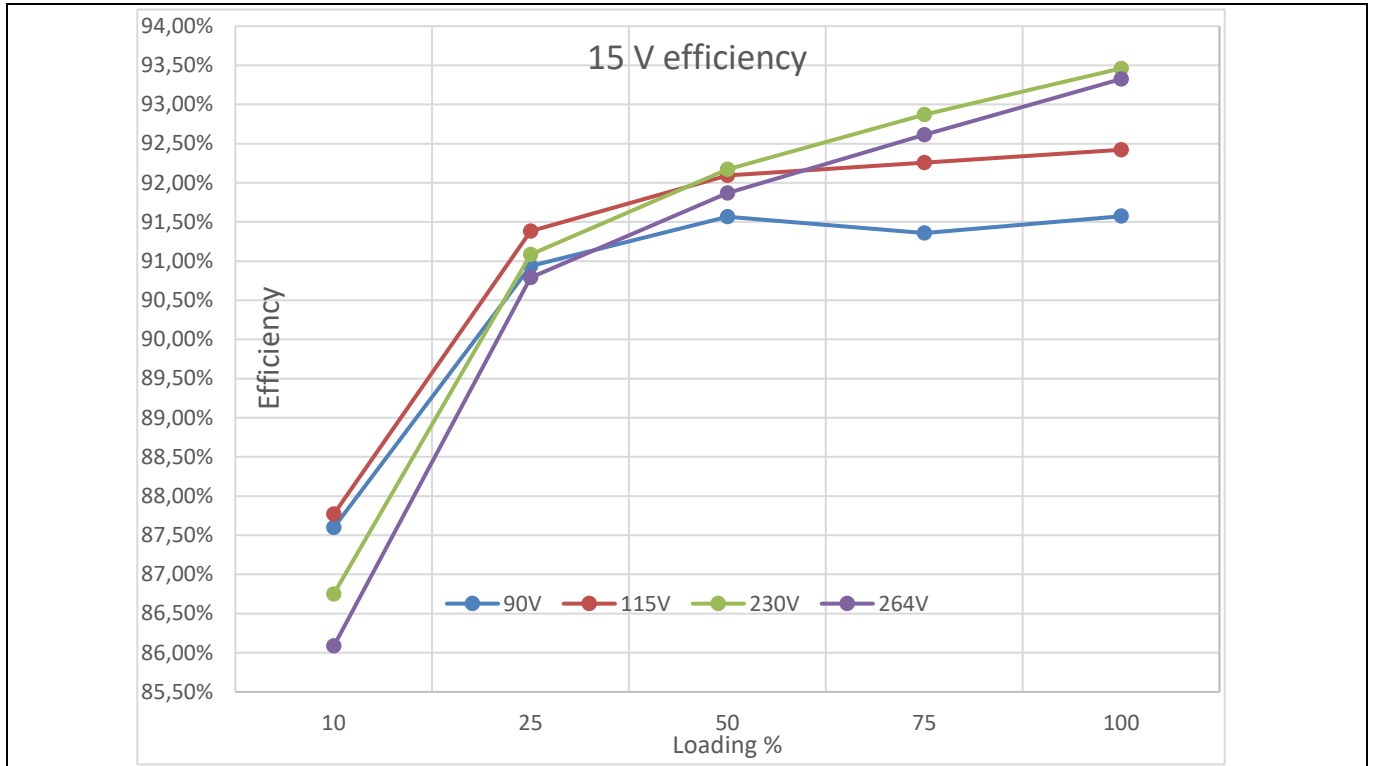

Figure 17 15 V output efficiency curves

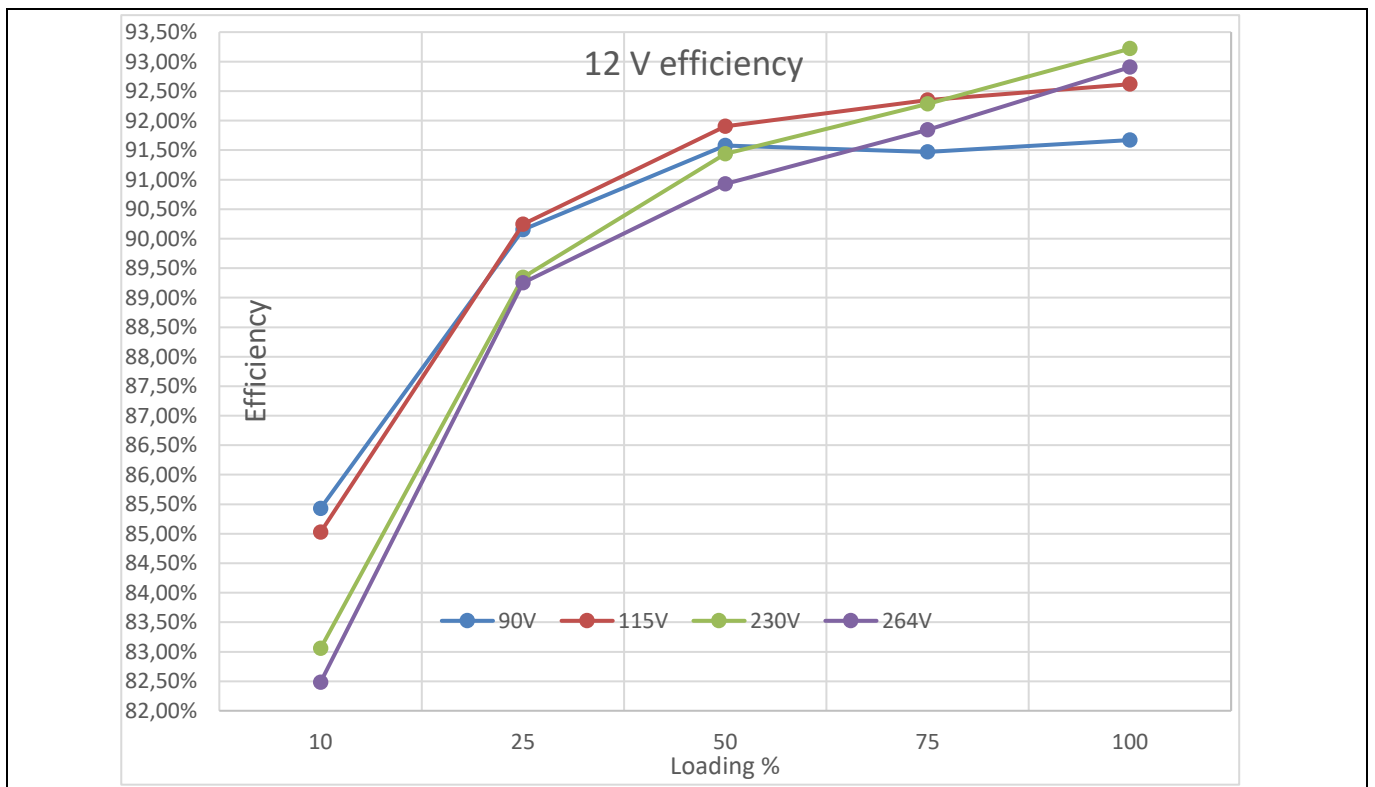

Figure 18 12 V output efficiency curves

Measurement results

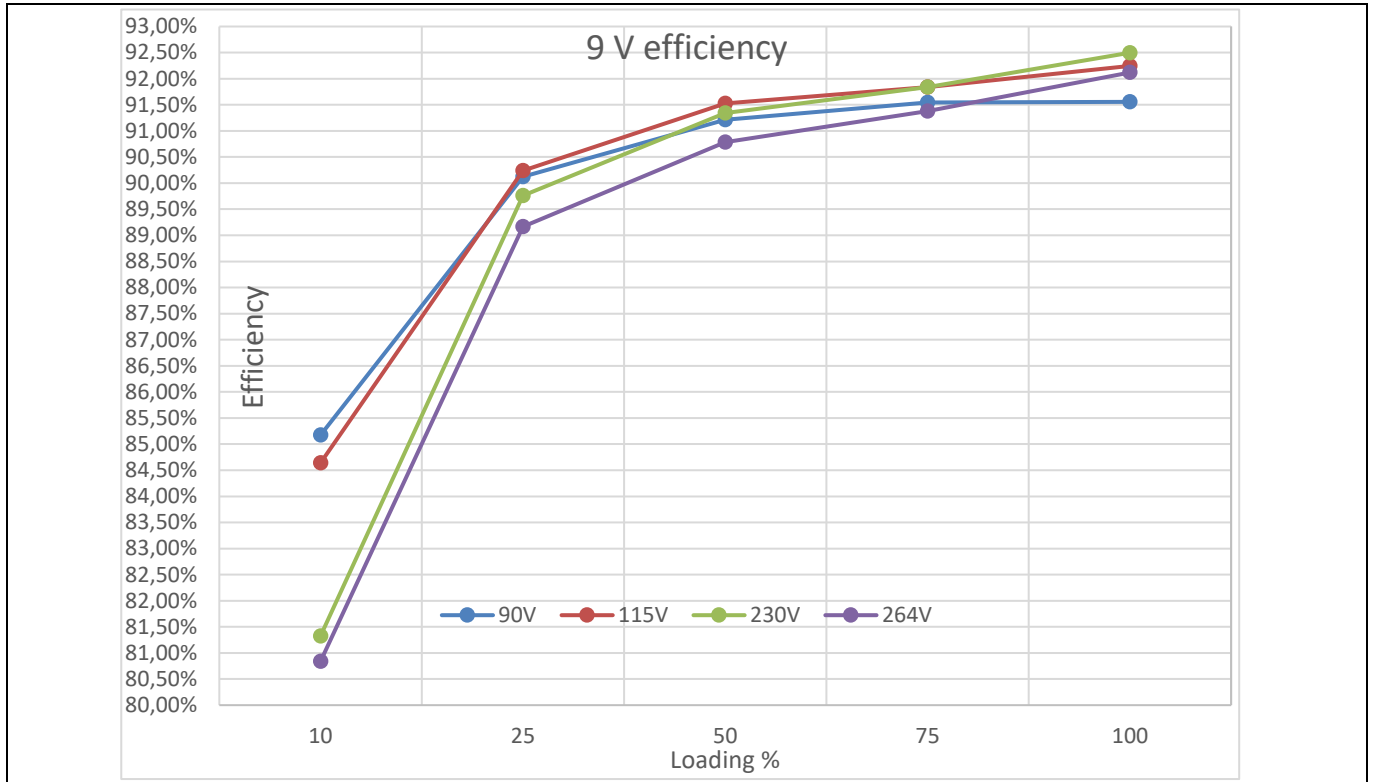

Figure 19 9 V output efficiency curves

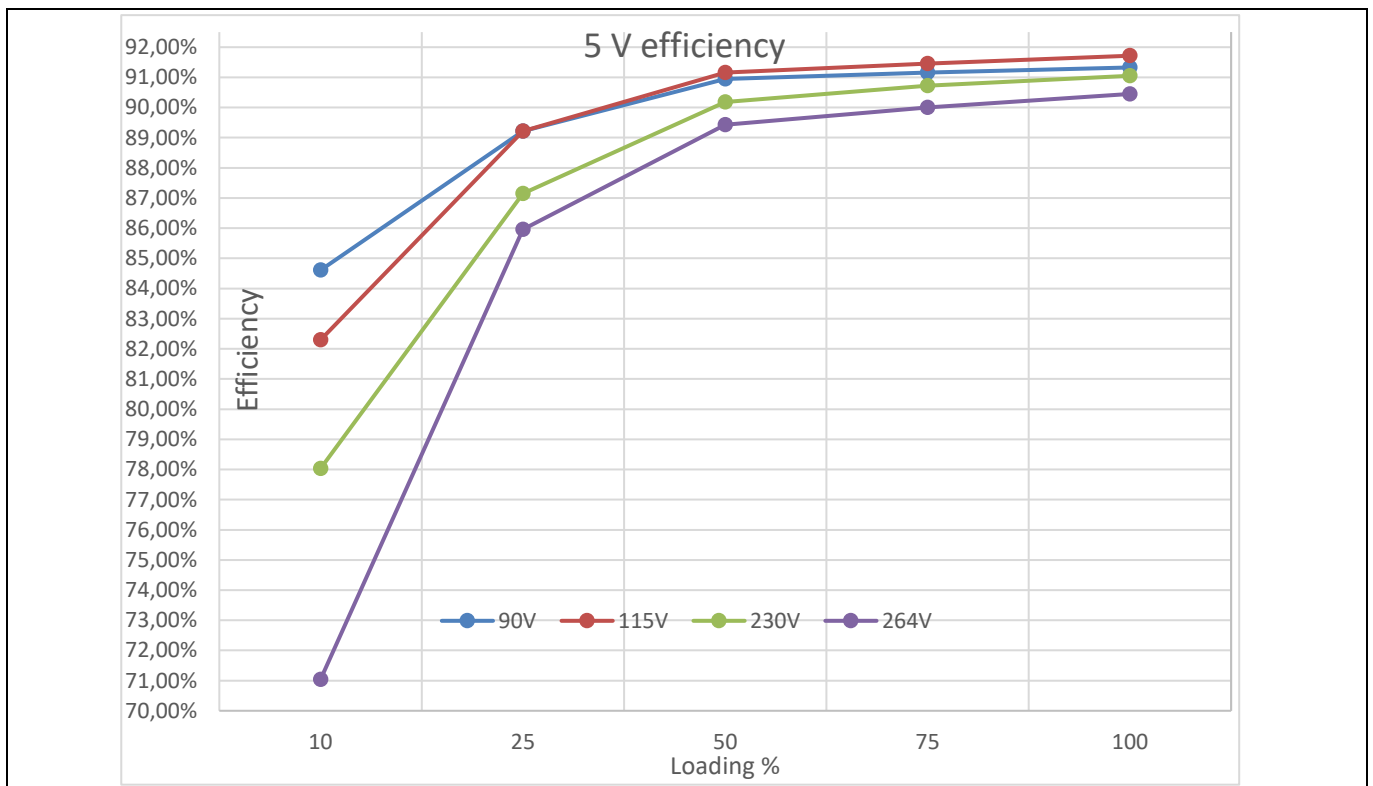

Figure 20 5 V output efficiency curves

Measurement results

10.2 Standby power

The standby power consumptions are measured from 90 V AC to 264 V AC at default 5 V output. They are less than 65 mW. Standby power is measured with a Yokogawa power meter WT210 and integrated in one minute.

Table 6 Standby power consumption

V _{out} (V)	Load (A)	Input voltage (AC)	Input power (mW)
5	0	90	23.3
		115	24.7
		230	48.2
		264	62.1

10.3 Output ripple – steady-state operation

The output ripple is measured at the PCB end at 0 A, and at full load with input voltages of 90 V AC and 264 V AC. 0.1 μF and 10 μF electric capacitors are used. Measured output ripple voltage is in steady-state (DC load current).

Table 7 Output ripple

V _{out} (V)	V _{in} (AC)	I _{out} (A)	V _{out_ripple} (mV)
5	90	0	82
		3	86
	264	0	85
		3	112
9	90	0	85
		3	102
	264	0	83
		3	129
12	90	0	79
		3	139
	264	0	96
		3	151
15	90	0	91
		3	173
	264	0	91
		3	194
20	90	0	94
		3.25	357
	264	0	124
		3.25	226

Measurement results

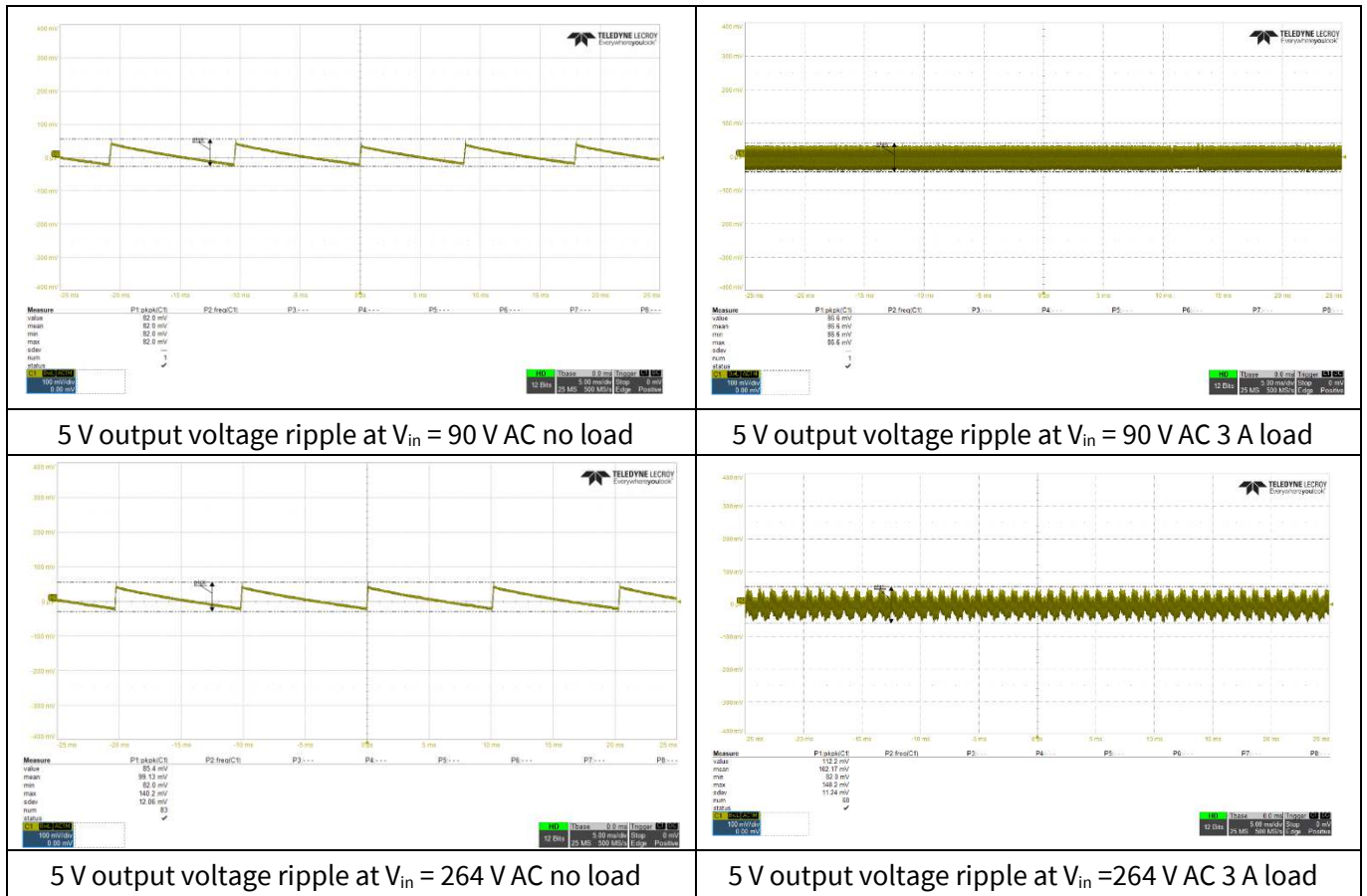

Figure 21 5 V output voltage ripple

Measurement results

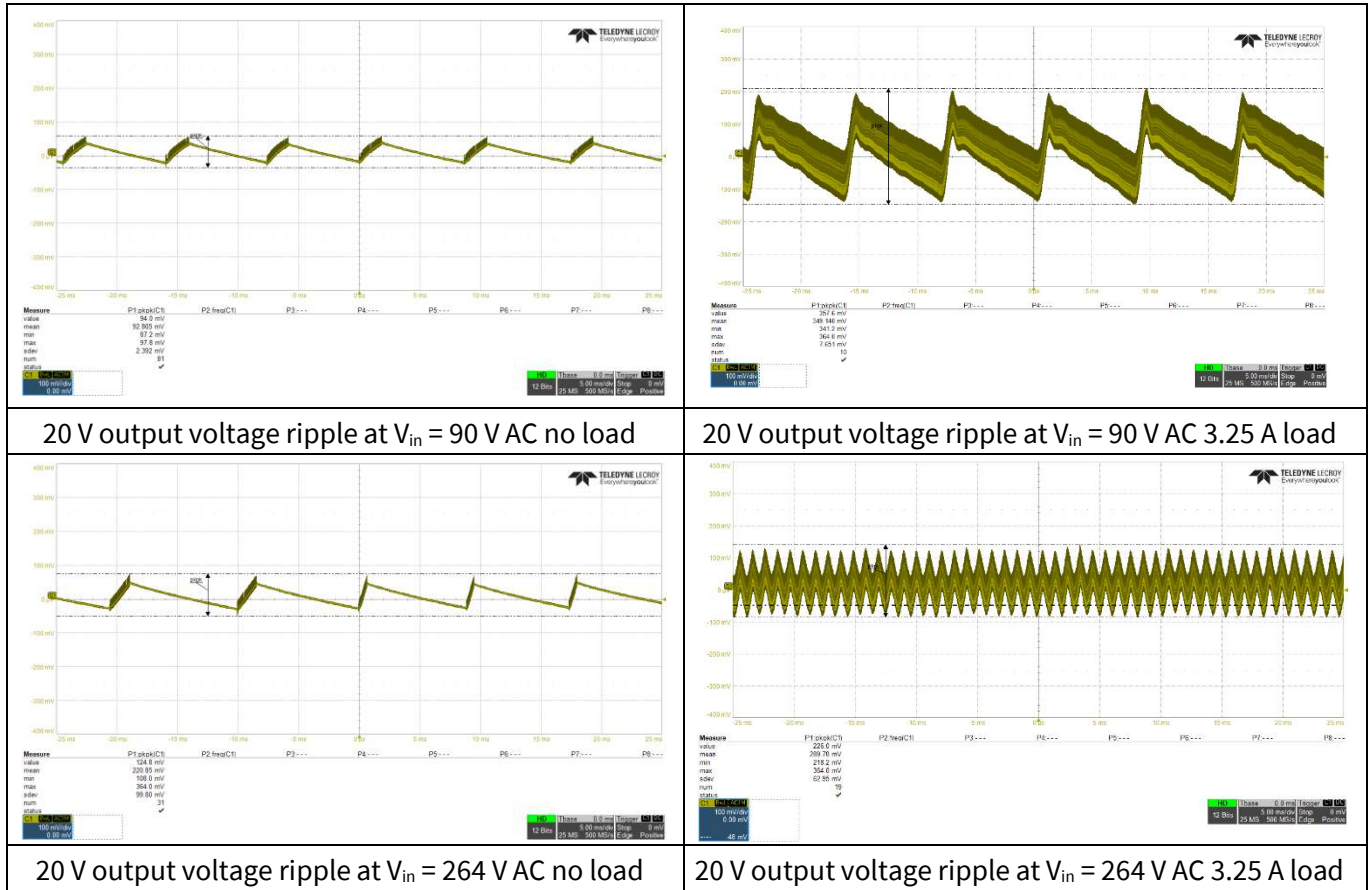

Figure 22 20 V output voltage ripple

10.4 Regulation under different loads

The steady-state output regulation is checked under various loadings and different input voltages, which pass +/-5 percent specification.

Table 8 Regulation check under 90 V AC with different loadings

90 V AC	No load	50 percent load	Full load
5 V	5.06	5.02	4.98
9 V	9.00	8.97	8.94
12 V	11.96	11.93	11.90
15 V	14.95	14.92	14.90
20 V	19.94	19.91	19.89

Measurement results
Table 9 Regulation check under 264 V AC with different loadings

264 V AC	No load	50 percent load	Full load
5 V	5.06	5.02	4.98
9 V	9.00	8.97	8.94
12 V	11.96	11.93	11.90
15 V	14.95	14.93	14.90
20 V	19.94	19.91	19.89

10.5 Dynamic load steps

The dynamic load steps from 0.75 A to 2.25 A, 0 A to 3.25 A with slew rate 0.8 A/μs are measured at 90 V AC and 264 V AC.

Table 10 Dynamic load step performance for load jumps

Test conditions	Output ripple peak-to-peak (mV)	
	90 V AC	264 V AC
25 percent to 50 percent load, 0.8 A/μs, 20 V _{out}	474	514
0 percent to 100 percent load, 0.8 A/μs, 20 V _{out}	1690	1590

Measurement results

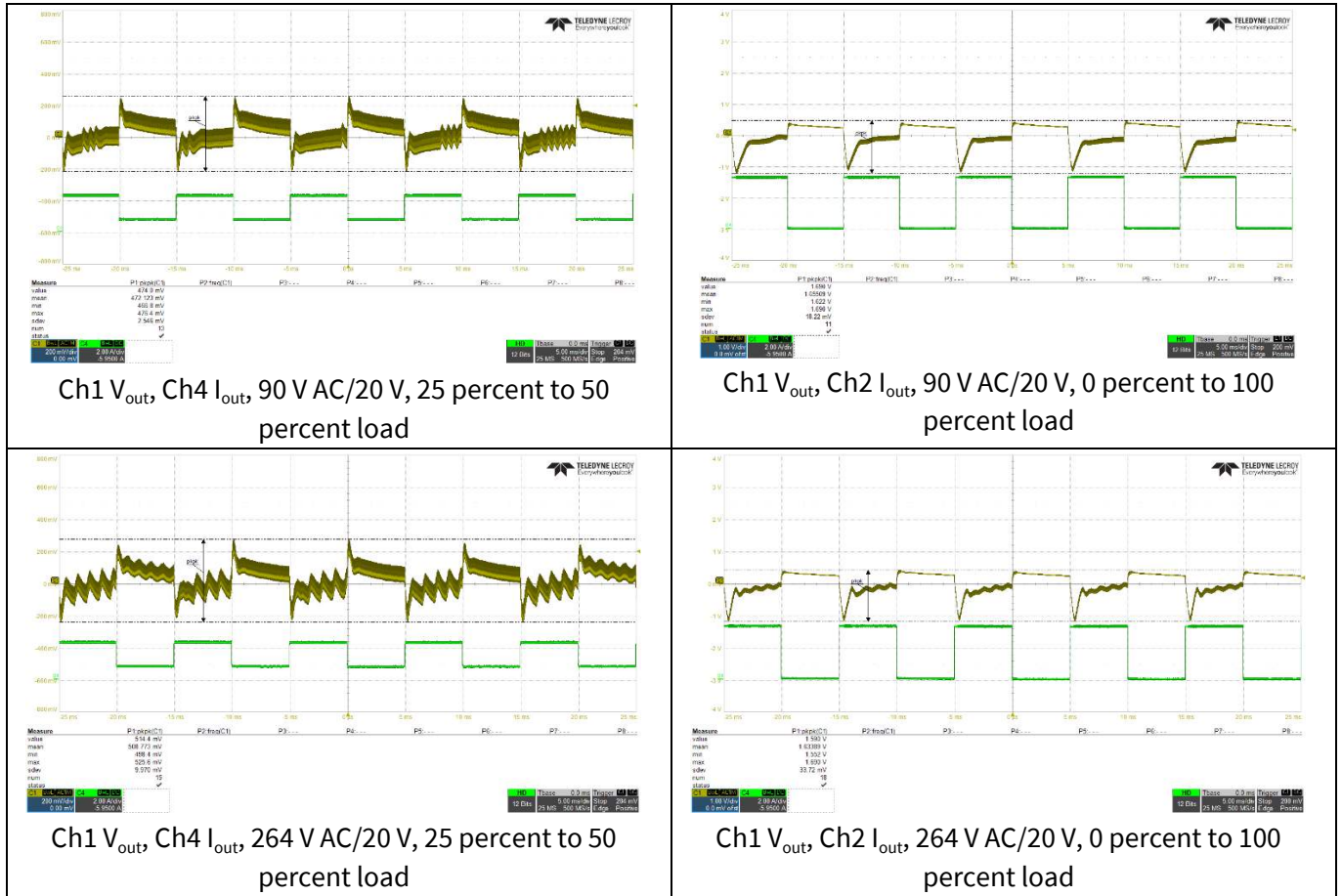

Figure 23 Dynamic load test

Measurement results
10.6 Loop stability

Bode plots were performed using industry-standard small-signal techniques.

Table 11 Loop bandwidth (BW), gain margin (GM) and phase margin (PM) for 90 V AC and 264 V AC

Items	Output	90 V AC	264 V AC
BW (kHz)	5 V/3 A	1.41	1.36
Phase (deg.)		46	43
Gain (dB)		12	12
BW (kHz)	9 V/3 A	1.08	1.07
Phase (deg.)		58	50
Gain (dB)		14	12
BW (kHz)	12 V/3 A	1.01	0.97
Phase (deg.)		52	50
Gain (dB)		13	13
BW (kHz)	15 V/3 A	1.02	1.04
Phase (deg.)		53	48
Gain (dB)		14	14
BW (kHz)	20 V/3.25 A	0.84	1.01
Phase (deg.)		52	48
Gain (dB)		16	14

Measurement results

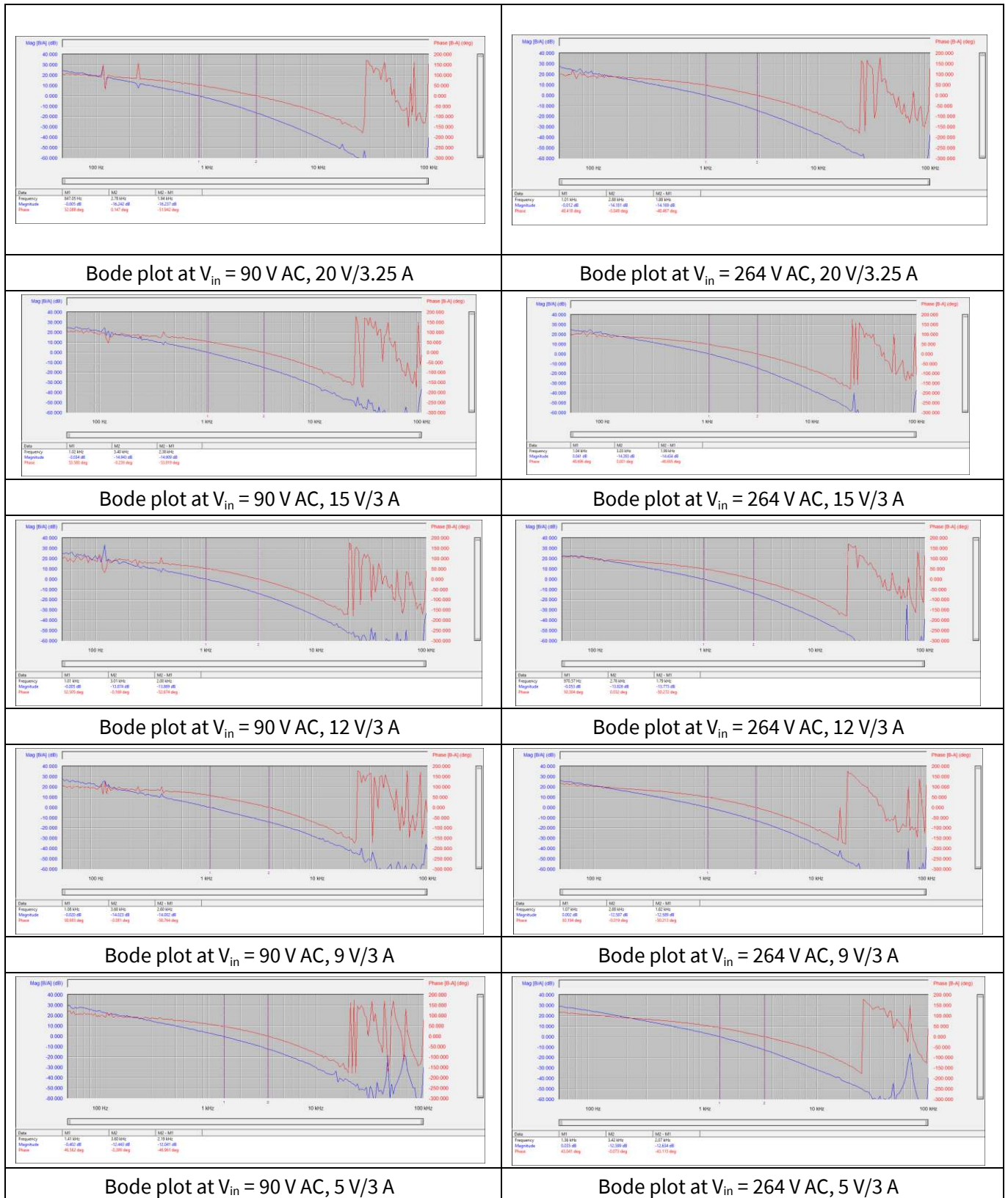
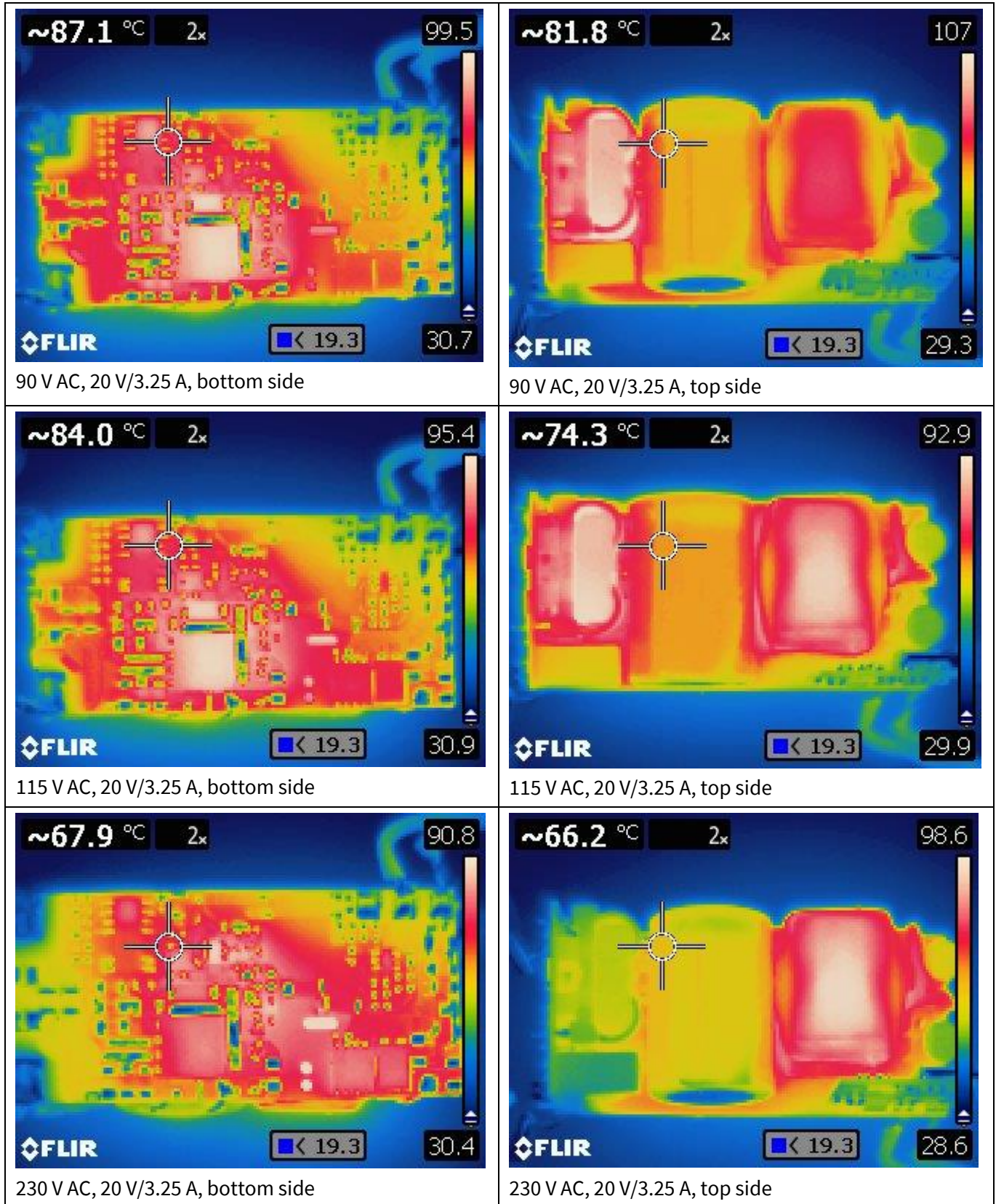

Figure 24 Bode plots

10.7 Measurement results

Thermal results were checked at different input voltages at 20 V/3.25 A after one hour's burn-in with a box to keep the temperature around PSU steady at room temperature.

Measurement results



Measurement results

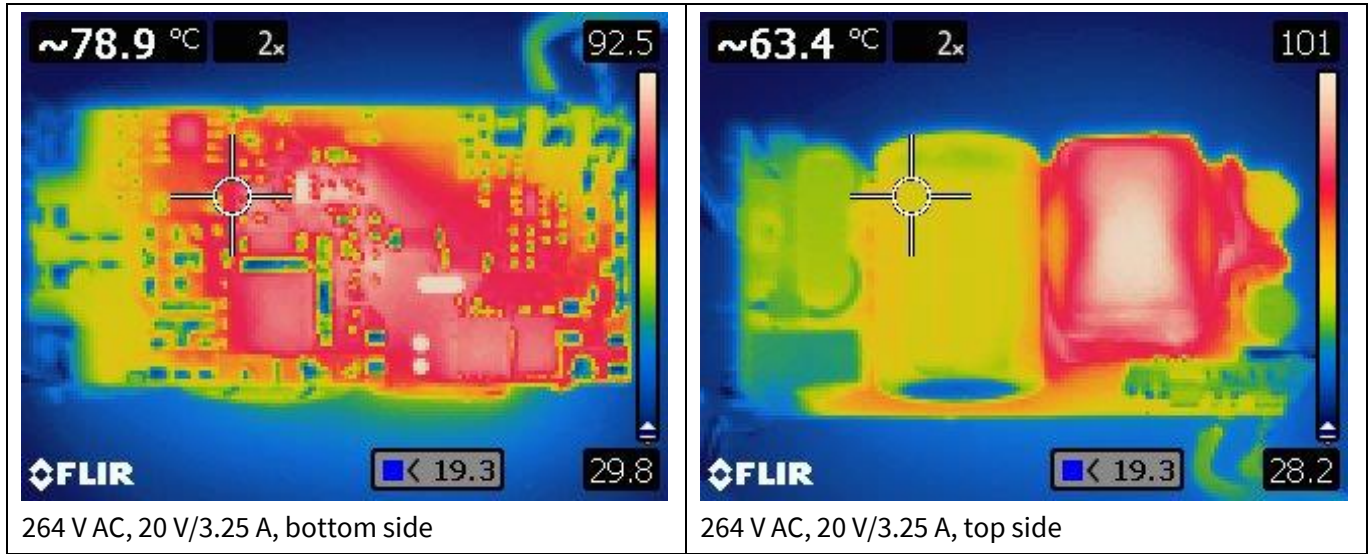

Figure 25 Thermal results

10.8 Conducted emissions (EN 55022 class B)

The conducted EMI was measured by a certified safety laboratory according to the test standard of EN 55022 (CISPR 22) class B. The demo board was setup at a different output full load with an input voltage of 110 V AC and 230 V AC. The system passed CISPR 22 class B.

Table 12 EMI test results under different output full loads

Output voltage (V)	110 V/L	110 V/N	230 V/L	230 V/N
20	Pass	Pass	Pass	Pass

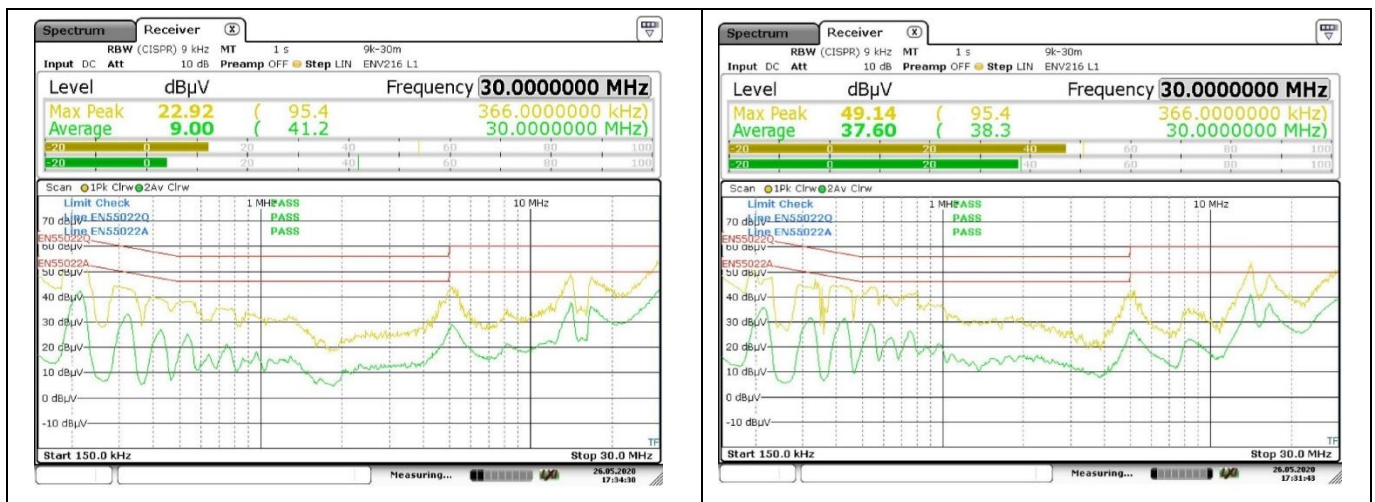

Figure 26 Conducted emissions at 110 V AC and 20 V/3.25 A load; neutral (left), live (right)

Measurement results



Figure 27 Conducted emissions at 230 V AC and 20 V/3.25 A load; neutral (left), live (right)

10.9 Operational waveforms

10.9.1 Main MOSFET switching waveform at low-/high-line

Even without ZVS MOSFET turning on, natural ZVS switching is achieved by QR operation with low-line input. For high-line input, the ZVS MOSFET Q6 turns on for a short time (on-time depends on input voltage and output voltage) so that the drain-source voltage of the main MOSFET would drop to a lower voltage before it turns on in order to achieve ZVS.

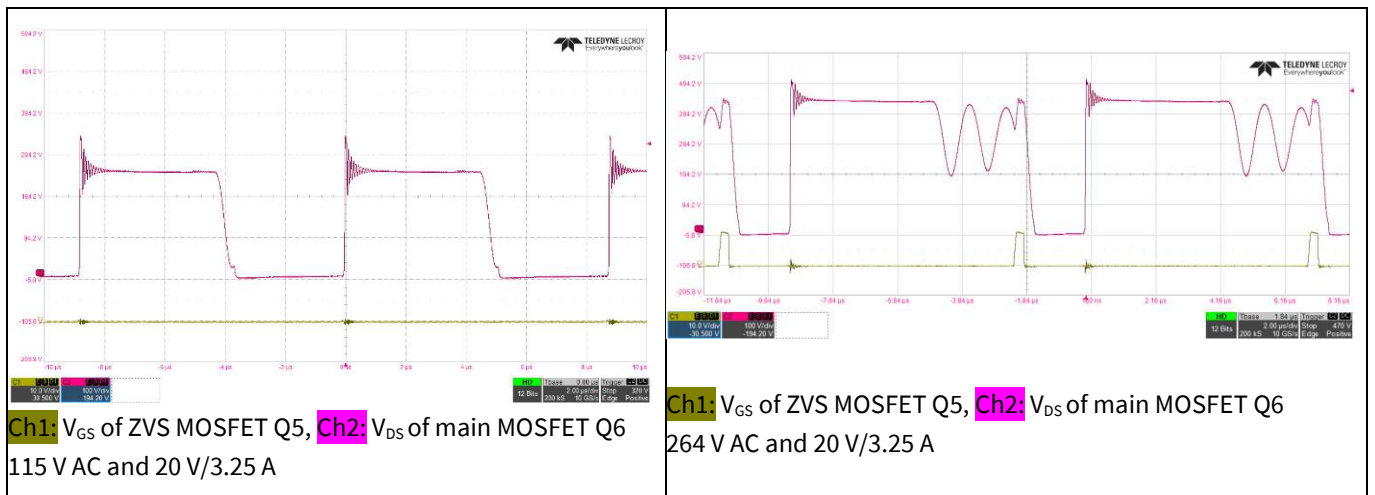
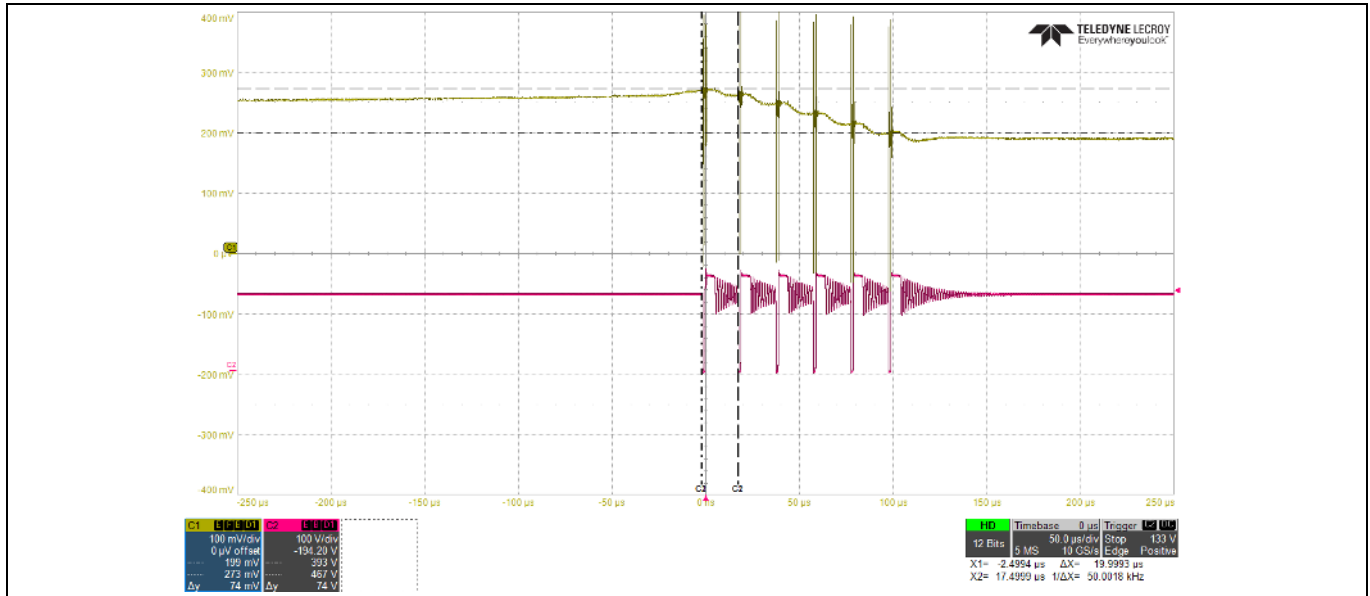

Figure 28 Switching waveforms

10.9.2 Burst mode (BM) waveform

When the system is running at light load, the controller will enter BM where the controller will only turn on the main MOSFET when the output voltage drops to a certain level corresponding to $V_{MFO} = 0.26 V$, and will sic off when the output voltage rises to a certain level corresponding to $V_{MFO} = 0.2 V$. During MOSFET turn-on, the switching frequency is set at 50 kHz.

Measurement results



BM waveform, Ch1: V_{MFIO} , Ch2: V_{DS} , 90 V AC, 5 V/0 A

Figure 29 BM waveform

10.10 V_{CC} charge time

The XDPS21081 will charge up the V_{CC} from the HV pin through the R_{HV} resistors tapping from the bulk capacitor. Since there is a R_{HV} resistor, the charging current is changed with different input voltage. The measured start-up at 90 V AC is 505 ms and at 230 V AC is 188 ms.

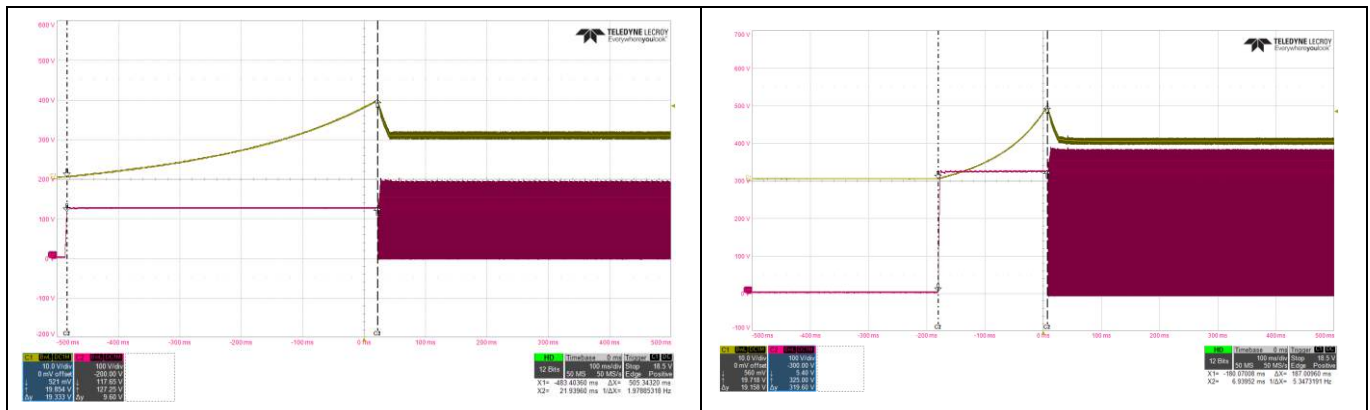

Start-up at $V_{in} = 90$ V AC at 5 V 1 A load, $t_{start-up} = 505$ ms

Start-up at $V_{in} = 230$ V AC at 5 V 1 A load, $t_{start-up} = 188$ ms

Figure 30 V_{CC} charge time waveforms

10.11 Brown-in/brown-out

The brown-in and brown-out control is through the sensing from the HV pin with an external resistor R_{HV} (102 k Ω) tapping from the bulk capacitor C2. The measured brown-in voltage is 119 V DC and the brown-out voltage is 42 V DC.

Measurement results

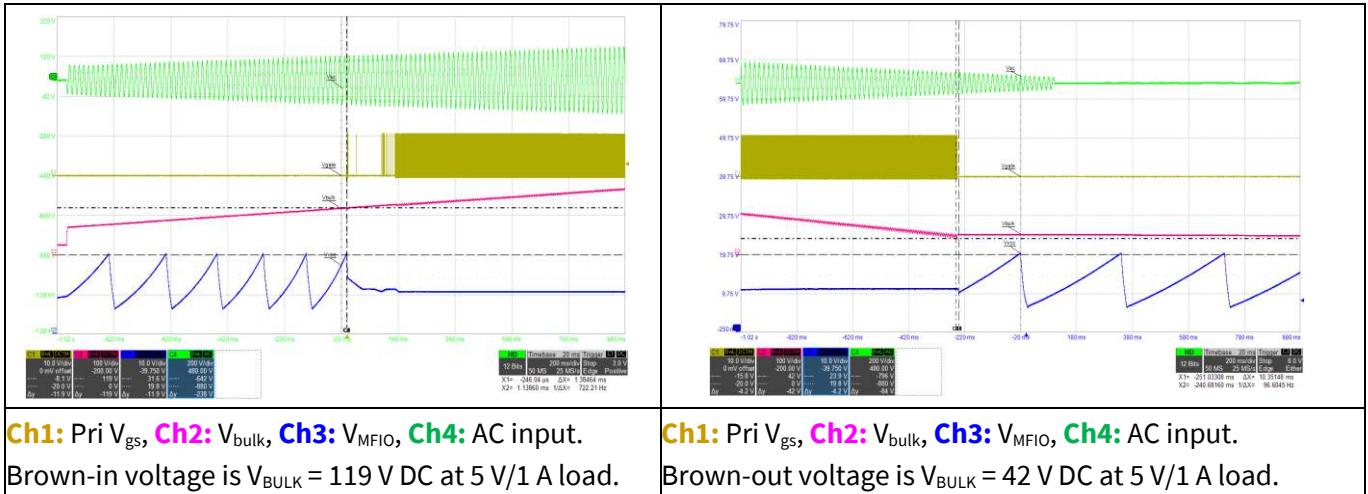

Figure 31 Brown-in/brown-out waveform

10.12 V_{out} OVP protection

V_{out} OVP is realized in the ZCD pin by sensing the ZCD winding where there is a voltage divider R21 and R23. The ZCD winding is a direct couple of the output winding. Therefore, whenever there is an output overvoltage, it would be reflected to the ZCD pin. The V_{out} OVP trigger level at the ZCD pin is 2.75 V. V_{out} output OVP is triggered by shorting the optocoupler on the secondary side. Figure 33 shows the OVP level of 22.8 V.

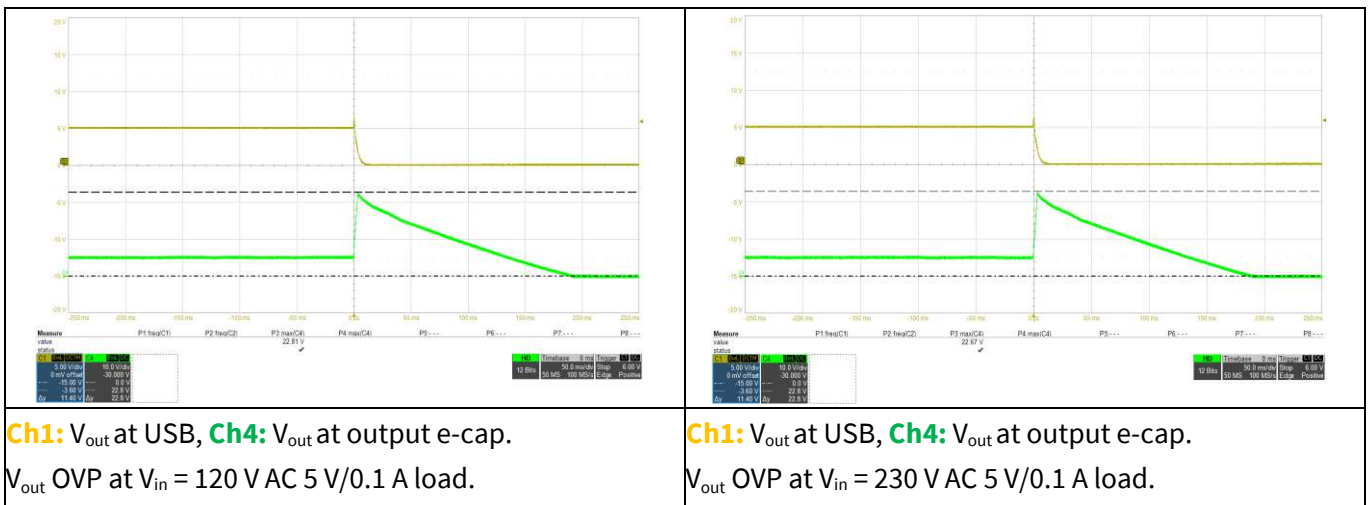

Figure 32 V_{out} OVP waveforms

10.13 Overload protection

OLP or output short-circuit protection prevents the output current from being too high, causing components to overheat and become damaged. The function is realized by the counter when V_{CS} reaches internal V_{CS_max} during output overload. When the blanking time 30 ms is passed, the system would enter auto restart mode. The below tests were performed with a secondary-side PD CS resistor shorted.

Measurement results

Table 13 OLP current limit at different line conditions

V_{in} (AC)	90	120	230	264
V_{out} (V)				
I_{out} (A)				
5	5.84 A	6.12 A	5.87 A	5.88 A
9	4.93 A	5.38 A	5.32 A	5.35 A
12	4.59 A	5.15 A	5.3 A	5.39 A
15	4.28 A	4.96 A	5.24 A	5.32 A
20	3.61 A	4.32 A	4.65 A	4.68 A

10.14 Output short-circuit protection

During full-load operation, E_{load} is connected to output e-cap, then shorts the output in E_{load} side; the IC first shuts down due to sufficient V_{CC} , then enters auto restart mode; restart timer is 3 s, which is the auto restart timer of XDPS21081.

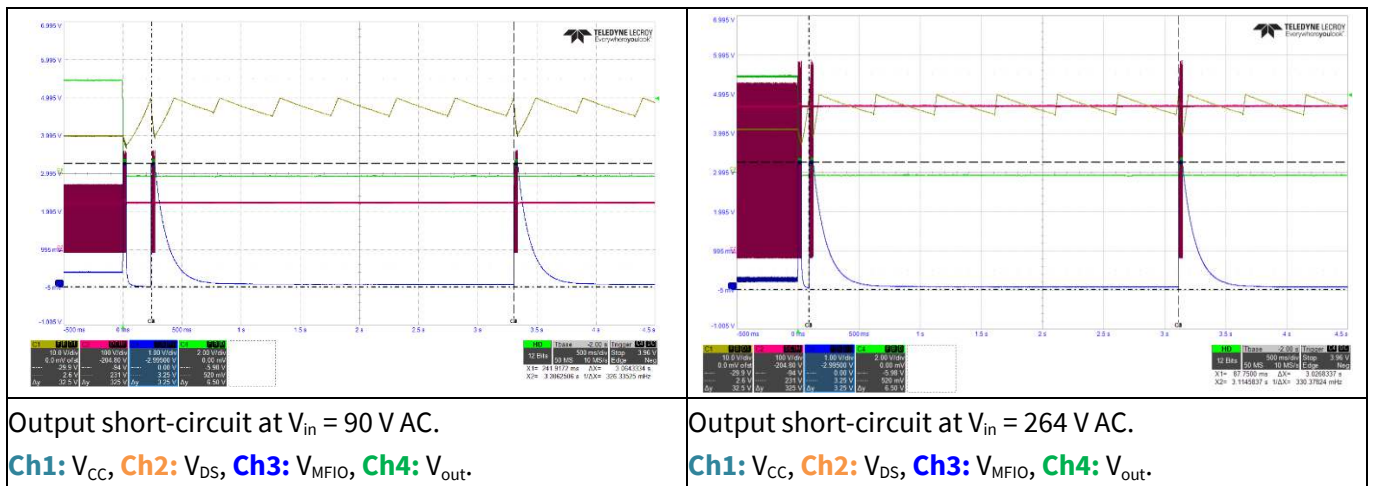

Figure 33 Output short-circuit protection waveforms

10.15 Current sense (CS) resistor short protection

During start-up, if the PWM main gate signal is longer than 1.4 μ s for a continuous three cycles, the IC will enter auto restart protection. The results below show R_{CS} short protection under 90 V AC and 264 V AC power-up.

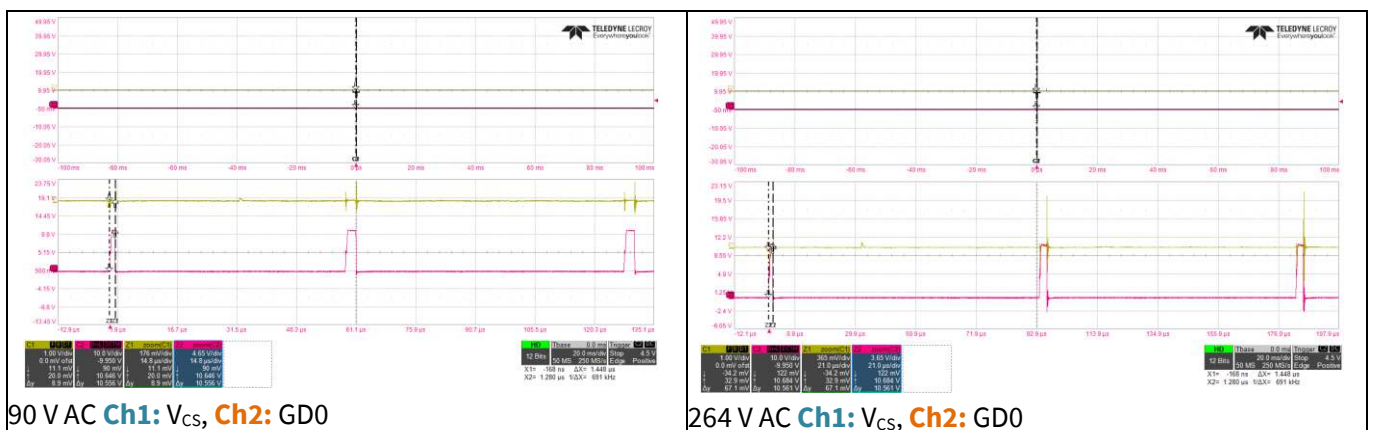

Figure 34 R_{CS} short protection waveforms

Measurement results

10.16 V_{CC} OVP

If V_{CC} reaches 22 V during operation, IC will enter auto restart mode with 3 s timer. This test is performed with V_{CC} regulator short.

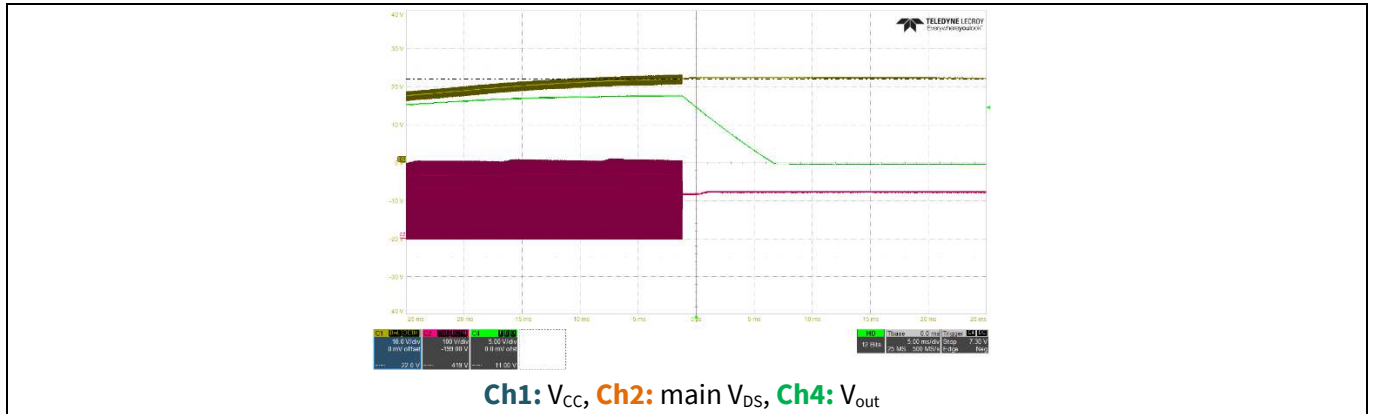

Figure 35 V_{CC} OVP waveforms

References

11 References

- [1] XDPS21081 datasheet V1.0, Infineon Technologies AG, 2020
- [2] IPL60R185C7 datasheet, Infineon Technologies AG, 2017
- [3] BSC0802LS datasheet, Infineon Technologies AG, 2019
- [4] BSL606SN datasheet, Infineon Technologies AG, 2013



Revision history

Revision history

Document version	Date of release	Description of changes
V 1.0	14-10-2020	First release
V 1.1	04-12-2020	Typo errors are fixed

Trademarks

All referenced product or service names and trademarks are the property of their respective owners.

Edition 2020-12-04

Published by

Infineon Technologies AG

81726 Munich, Germany

© 2021 Infineon Technologies AG.

All Rights Reserved.

Do you have a question about this document?

Email: erratum@infineon.com

Document reference

AN_2008_PL21_2009_100531

IMPORTANT NOTICE

The information contained in this application note is given as a hint for the implementation of the product only and shall in no event be regarded as a description or warranty of a certain functionality, condition or quality of the product. Before implementation of the product, the recipient of this application note must verify any function and other technical information given herein in the real application. Infineon Technologies hereby disclaims any and all warranties and liabilities of any kind (including without limitation warranties of non-infringement of intellectual property rights of any third party) with respect to any and all information given in this application note.

The data contained in this document is exclusively intended for technically trained staff. It is the responsibility of customer's technical departments to evaluate the suitability of the product for the intended application and the completeness of the product information given in this document with respect to such application.

For further information on the product, technology, delivery terms and conditions and prices please contact your nearest Infineon Technologies office (www.infineon.com).

WARNINGS

Due to technical requirements products may contain dangerous substances. For information on the types in question please contact your nearest Infineon Technologies office.

Except as otherwise explicitly approved by Infineon Technologies in a written document signed by authorized representatives of Infineon Technologies, Infineon Technologies' products may not be used in any applications where a failure of the product or any consequences of the use thereof can reasonably be expected to result in personal injury.