

MB88121 SERIES MB91460 SERIES STARTER KIT SK-91F467-FLEXRAY

USER GUIDE

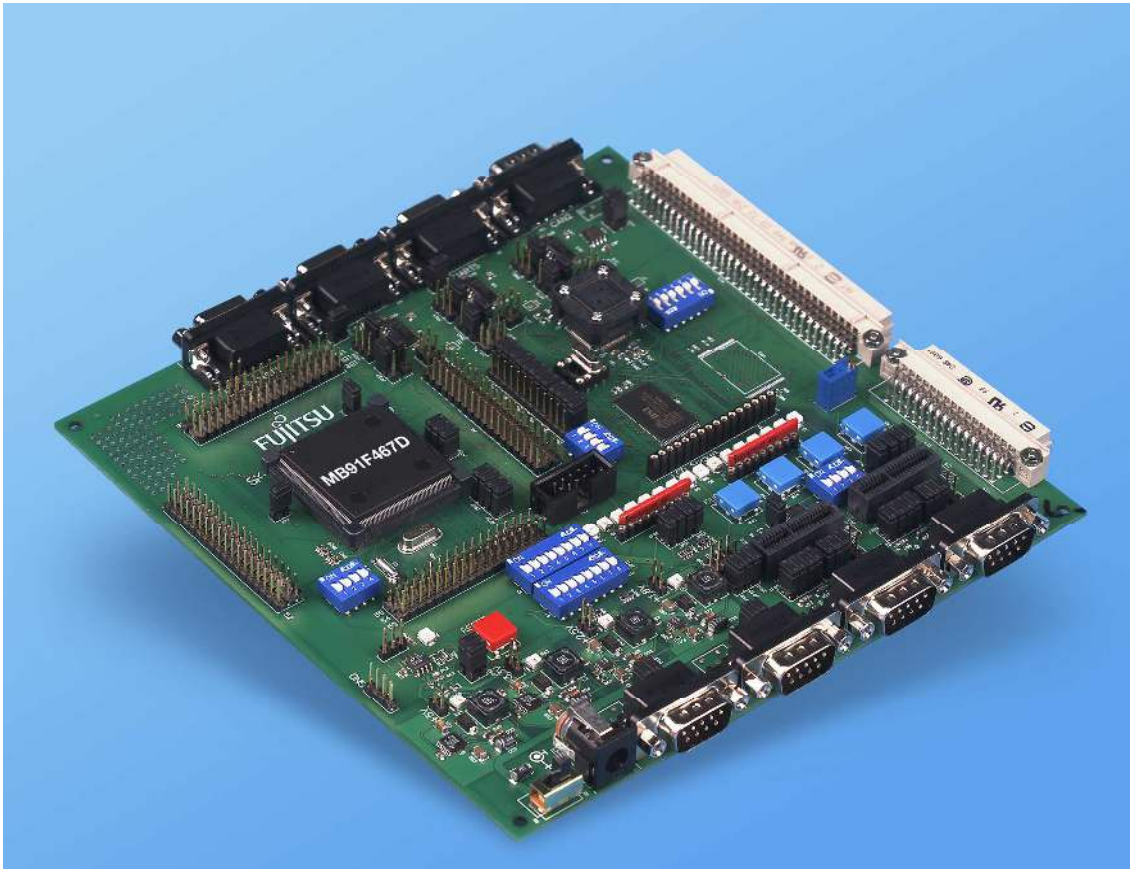

Revision History

Date	Issue
22/11/2005	V1.0, MSt, first official version
01/06/2006	V1.1, MSt SK-91F467D-208PFV information removed, Getting started chapter changed to new Monitor debugger version
22/09/2006	V1.2 MSt MB88121B support information added Reset circuit: information of new resistor value added
	V1.3, MSt Chapter 3.6 table entries for RXDx and TXDx corrected Chapter 5 Connection between MB91F467DA and MB88121 added
02/03/2007	V1.4 Recycling Note added
16/04/2007	V1.5, MSt Chapter 5 completed
13/08/2007	V1.6, MSt Information about MB88121B usage added
05/09/2008	V1.7, MSc, China-RoHS regulation added

This document contains 81 pages.

Warranty and Disclaimer

To the maximum extent permitted by applicable law, Fujitsu Microelectronics Europe GmbH restricts its warranties and its liability for **the SK-91F467-FLEXRAY and all its deliverables** (eg. software include or header files, application examples, target boards, evaluation boards, engineering samples of IC's etc.), its performance and any consequential damages, on the use of the Product in accordance with (i) the terms of the License Agreement and the Sale and Purchase Agreement under which agreements the Product has been delivered, (ii) the technical descriptions and (iii) all accompanying written materials. In addition, to the maximum extent permitted by applicable law, Fujitsu Microelectronics Europe GmbH disclaims all warranties and liabilities for the performance of the Product and any consequential damages in cases of unauthorised decompiling and/or reverse engineering and/or disassembling. **Note, the SK-91F467-FLEXRAY board and all its deliverables are intended and must only be used in an evaluation laboratory environment.**

1. Fujitsu Microelectronics Europe GmbH warrants that the Product will perform substantially in accordance with the accompanying written materials for a period of 90 days from the date of receipt by the customer. Concerning the hardware components of the Product, Fujitsu Microelectronics Europe GmbH warrants that the Product will be free from defects in material and workmanship under use and service as specified in the accompanying written materials for a duration of 1 year from the date of receipt by the customer.
2. Should a Product turn out to be defect, Fujitsu Microelectronics Europe GmbH's entire liability and the customer's exclusive remedy shall be, at Fujitsu Microelectronics Europe GmbH's sole discretion, either return of the purchase price and the license fee, or replacement of the Product or parts thereof, if the Product is returned to Fujitsu Microelectronics Europe GmbH in original packing and without further defects resulting from the customer's use or the transport. However, this warranty is excluded if the defect has resulted from an accident not attributable to Fujitsu Microelectronics Europe GmbH, or abuse or misapplication attributable to the customer or any other third party not relating to Fujitsu Microelectronics Europe GmbH.
3. To the maximum extent permitted by applicable law Fujitsu Microelectronics Europe GmbH disclaims all other warranties, whether expressed or implied, in particular, but not limited to, warranties of merchantability and fitness for a particular purpose for which the Product is not designated.
4. To the maximum extent permitted by applicable law, Fujitsu Microelectronics Europe GmbH's and its suppliers' liability is restricted to intention and gross negligence.

NO LIABILITY FOR CONSEQUENTIAL DAMAGES

To the maximum extent permitted by applicable law, in no event shall Fujitsu Microelectronics Europe GmbH and its suppliers be liable for any damages whatsoever (including but without limitation, consequential and/or indirect damages for personal injury, assets of substantial value, loss of profits, interruption of business operation, loss of information, or any other monetary or pecuniary loss) arising from the use of the Product.

Should one of the above stipulations be or become invalid and/or unenforceable, the remaining stipulations shall stay in full effect

Contents

REVISION HISTORY	2
WARRANTY AND DISCLAIMER	3
CONTENTS	4
1 INTRODUCTION.....	7
1.1 Abstract.....	7
1.2 Features.....	8
1.3 General Description.....	9
1.3.1 On Board Memory	10
1.3.2 MCU Clocks.....	10
1.3.3 MCU Operating Mode.....	10
1.3.4 FlexRay CC Clock	10
1.3.5 FlexRay CC-MCU Connection	10
1.3.6 External Bus interface Connectors.....	10
1.3.7 FlexRay Physical Layer	10
1.3.8 CAN Bus.....	10
1.3.9 RS-232 and LIN.....	10
1.3.10 MCU Pins11	
1.3.11 User Buttons.....	11
1.3.12 User LEDs and optional LCD.....	11
1.3.13 Power Supply	11
2 INSTALLATION	12
2.1 Jumper Settings	14
2.2 Jumper Location.....	16
2.3 Software Installation	17
2.3.1 Installation of Softune Workbench	17
3 JUMPERS AND SWITCHES.....	19
3.1 MCU Operating-Mode (S5).....	19
3.2 FlexRay CC Operating-Mode (S2).....	20
3.3 FlexRay CC SPI Settings (S1).....	21
3.4 Power Supply	22
3.4.1 MCU Power Supply Voltage	24
3.4.2 MCU Analogue Power Supply Voltage.....	24
3.4.3 FlexRay CC Power Supply Voltage at SK-91F467-FLEXRAY.....	25
3.4.4 Change FlexRay CC Power supply to MB88121B	26

3.5	MCU-FlexRay CC Connection at SK-91F467-FLEXRAY	27
3.6	FlexRay Physical Layer	28
3.6.1	Channel A.....	28
3.6.2	Channel B.....	29
3.6.3	FT1080 Control Settings (S6)	31
3.7	CAN0 – CAN2	32
3.8	LIN / RS-232 UART	32
3.8.1	UART 2.....	33
3.8.2	UART 4 (Flash programming).....	34
3.8.3	UART 5.....	35
3.9	User Push Buttons INT0, INT1, INT2 and ICU0/TIN0	36
3.10	User DIP Switch 8 Bit (S4)	36
3.11	Reset Generation	37
4	CONNECTORS.....	39
4.1	Power Connector (X5).....	39
4.2	UART / LIN Connector (X1, X4, X8)	39
4.3	CAN Connector (X9, X10, X11)	40
4.4	FlexRay Connector (X2, X6).....	40
4.5	FlexRay Physical Layer Module Connector (X3, X7)	41
4.6	USER-LEDs and optional LC-Display (D1-D16, J6).....	42
4.7	In-Circuit-Programming Connector (X12)	43
4.8	MCU Pin Connectors (J1-J4).....	43
4.9	External Bus Connectors (X13, X14).....	44
4.9.1	VG96ABC DIN 41612 (X13)	44
4.9.2	VG48ABC DIN 41612 (X14)	45
4.9.3	Distance between VG-Connectors.....	45
5	CONNECTION BETWEEN MB91F467DA AND MB88121	46
5.1	Settings for 16-bit none-multiplexed parallel bus interface.....	47
5.2	Settings for 16-bit multiplexed parallel bus interface.....	48
5.3	Settings for SPI interface.....	49
6	GETTING STARTED.....	50
6.1	Introduction to Softune Workbench	50
6.2	Project Start-up	52
6.2.1	Create a New Project:.....	52
6.2.2	Use Active Configuration MONDEBUG_INTERNAL	54
6.2.3	Use Active configuration STANDALONE	56
6.3	Softune Workbench Monitor Debugger.....	57

6.3.1	General Description	57
6.3.2	Basic Debugger Features	60
6.4	Advanced Monitor Debugger Features	61
6.5	Memory Configuration for User Applications.....	64
7	FLASH PROGRAMMING.....	66
7.1	Programming internal Flash of MB91F467DA series	66
8	TROUBLE SHOOTING	69
9	SILK-PLOT OF THE BOARD	70
9.1	Top Side.....	70
9.2	Bottom Side.....	71
10	PCB HISTORY	72
10.1	SK-91F467-FLEXRAY V1.0	72
10.2	SK-91F467-FLEXRAY V1.1	72
11	APPENDIX.....	73
11.1	Related Products.....	73
11.2	Information on the WWW	74
11.3	Tables	75
11.4	Figures	77
11.5	Abbreviations	78
12	CHINA-ROHS REGULATION	79
13	RECYCLING	81

1 Introduction

1.1 Abstract

The SK-91F467-FLEXRAY is a multifunctional development board for the FUJITSU FlexRay communication controller MB88121 and the 32-bit Flash microcontroller MB91F467DA. It can be used stand alone for software development and testing or together with monitor-debugger software.

The board allows the designer immediately to start with the software and system development, before his own final target system is available.

1.2 Features

- Supports 32-bit Flash microcontroller MB91F467D
- Supports FlexRay CC MB88121
- 9-12V (2000mA) unregulated external DC power supply
- 5V, 3.3V, 2.5V and 1.8V on-board switching regulators with power status-LEDs
- Triple supply monitor to watch 5V, 3.3V and selectable 2.5V or 1.8V
- On-board Memory:
 - 32Mbit (4MByte) SRAM
- It is possible to connect the FlexRay CC in different ways to the MCU
 - 16 bit non multiplexed / multiplexed bus
 - 8 bit non multiplexed / multiplexed bus
 - SPI communication
- All microcontroller resources available for evaluation
- All microcontroller pins routed to pin header
- In-Circuit serial Flash programming
- Three selectable RS-232 or LIN UART-interfaces
- Three High-Speed CAN interfaces
- Two FlexRay channels (Ch-A, Ch-B)
 - FlexRay physical layer RS-485 available
 - FlexRay physical layer driver module from TSM (FT1080) connectable
- 16 User LEDs
 - optional: alphanumeric standard LC-Display connectable
- Reset button, Reset-LED
- 4 User buttons, one 8 bit MCU port can be connected to DIP switches
- External bus interface routed to 96pin and 48pin DIN 41612 (VG) connectors

**This board must only be used for test applications
in an evaluation laboratory environment.**

1.3 General Description

The SK-91F467-FLEXRAY supports the FUJITSU 32-bit Flash microcontroller MB91F467D and the FUJITSU FlexRay stand alone communication controller MB88121.

The Starter Kit can be used as a stand-alone development platform, or if a MCU socket is soldered instead of the Flash MCU MB91F467D, with the emulation system MB91V460 adapter board (MB2198-300) and 208 pin probe cable board (PB-91467D-NLS-208PFV).

This User Guide is describing PCB version V1.1. The PCB version is printed at the TOP side of the starter kit close to MB91F467D MCU [U1].

Note:

Since PCB production Code 18-47/06 the MB88121B series is used instead of MB88121A series.

1.3.1 On Board Memory

The starter kit includes 32MBit (4MByte) SRAM memory on board. The SRAM can be used with 5V, or with 3.3V external bus supply voltage.

1.3.2 MCU Clocks

The board is supplied with a 4MHz crystal as the main oscillation clock for the MCU. Using the internal PLL of the MCU, internal clock rates up to 100MHz can be achieved. The MCU sub clock is connected to a 32.768 kHz crystal.

1.3.3 MCU Operating Mode

The operating mode of the microcontroller can be selected with the Dip-switch S5.

1.3.4 FlexRay CC Clock

The FlexRay CC clock is operated by a 10MHz crystal mounted in a socket. By removing the 10MHz crystal it is also possible to use an external clock oscillator.

1.3.5 FlexRay CC-MCU Connection

The FlexRay CC (MB88121) is connected to the MCU via external bus. It is possible to use it in 8 bit / 16 bit multiplexed, 8 bit / 16 bit non multiplexed or SPI communication-mode (dependent from revision of MB88121). With jumper or switches the user can change between the different modes.

1.3.6 External Bus interface Connectors

Via DIN 41612 VG96ABC and VG48ABC connectors (external bus interface of the MCU), it is possible to connect the FlexRay FPGA Board to the Starter Kit and use the FPGA as FlexRay communication controller. It is also possible to connect other devices e.g. user applications or Fujitsu graphic device sub boards.

1.3.7 FlexRay Physical Layer

The connection to the physical layer of the FlexRay bus with 9-pin D-Sub connectors (X2 and X6) is realized with RS485 transceiver, or it is also possible to deselect the RS485 transceiver and use pluggable physical layer driver module from TSM (FT1080) instead.

1.3.8 CAN Bus

Three high-speed CAN-transceivers (PCA82C250) are available to connect all available on-chip CAN-controllers to 9-pin D-Sub connectors (X9, X10 and X11). The transceivers provides differential transmit and receive capability between CAN-controller and CAN-bus.

1.3.9 RS-232 and LIN

RS-232 and LIN signals are shared on the 9-pin D-Sub connectors (X1, X4 and X8). It can be selected, if RS-232 or LIN will be used.

Three separate RS-232 transceivers and three separate LIN transceivers are available, to connect the on-chip USARTs to the 9-pin D-Sub connectors.

The RS-232 transceivers generate the adequate RS-232 levels for receive (RXD) and transmit (TXD) lines. The RTS signal can be shortcut to CTS using jumpers (some PC software needs this connection, when a 1:1 cable is used).

Either the DTR line or the RTS line of X1, X4 or X8 connectors can be selected to generate a system reset.

The LIN transceivers (TLE6259) generate the adequate levels to drive the bus line in LIN-systems for automotive and industrial applications.

1.3.10 MCU Pins

All 208 pins of the microcontroller are connected to the edge connectors J1, J2, J3 and J4 and are directly available to the user.

1.3.11 User Buttons

There are four push buttons on board, which can be connected to input-ports of the microcontroller. Some ports may support additional functions like external interrupts (INT0, INT1 and INT2) and trigger for the Reload Timer or Input-Capture (TIN0 / ICU0). One additional button is reserved as System-Reset-button to reset the MCU and the FLEXRAY CC simultaneously, but it is possible to disconnect the RST-ports with JP52 or JP54.

It is possible to connect with Dip-switch S3 eight port input switches at S4 to the MCU port P26_D0 – P26_D7. All eight ports can be switched separately to use e.g. only four ports as input.

1.3.12 User LEDs and optional LCD

Sixteen user-LEDs are connected via two pull-down resistor networks to port P25_D0 - P25_D7 and to port P16_D0 - P16_D7. Parallel to the LEDs on port P25, the connector J6 can be used to connect a standard alphanumeric display. The resistor networks RN2 and RN3 can be removed, to free the ports.

1.3.13 Power Supply

The four on-board step-down switching regulators allow the user to connect an unregulated DC input voltage between +9V to +12V (max. 2000mA) to the starter-kit. The switching regulators provide the voltages of 5V (3A), 3.3V (3A), 2.5V (1,5A) and 1.8V (1,5A) on the starter kit. These voltages give also the possibility, to connect an optional graphic-controller starter kit to the board. The switching regulators are short circuit protected and provide a thermal shutdown.

If the SK-91F467-FLEXRAY starter-kit is connected to the Fujitsu FlexRay FPGA-board it is possible, that the power supply for the SK-91F467-FLEXRAY will be provided by the FPGA-board and a power supply connection to the SK-91F467-FLEXRAY is not needed. For that case the pins 14B, 15B and 16B of DIN 41612 VG48ABC connector X14 are used as voltage input behind the SK-91F467-FLEXRAY on-board power switch, so that the power switch on the FPGA board switches the whole system.

2 Installation

Remove the board carefully from the shipping carton.

First check if there are any damages before power on the starter kit.

To supply the starter kit, use the delivered In-Plug AC-DC Adapter (UPA 2000). Select the AC plug adapter suitable for your country power sockets



Figure 2-1: AC plug adapter

and insert this adapter into the connection terminal on the AC-DC adapter.

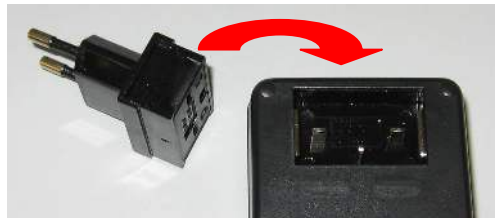

Figure 2-2: AC plug adapter selection

Check the selected output DC voltage of the AC-DC In-Plug adapter at the voltage selection key. It should be 9V! Change the output voltage only in a powered-down condition!



Figure 2-3: DC voltage selection

Select the low voltage adapter suitable to the power connector X5 at the SK-91F467-FLEXRAY and plug it to the connecting socket in the right orientation (+ connected to shield and GND connected to centre pin).



Figure 2-4: Low voltage adapter selection

Now connect the DC low voltage adapter to the Starter kit and plug in the In-Plug Power Supply to a power socket. The SK-91F467-FLEXRAY can be turned on with the on board power switch S8 (or S9).

For the power supply of the SK-91F467-FLEXRAY a DC input voltage of 9V – 12V is recommended. The positive voltage (+) must be connected to the shield, and ground (GND) must be connected to the centre of the connector X5!

After power-on of the SK-91F467-FLEXRAY, the four red power-on LEDs D24 (5V), D30 (3.3V), D34 (2.5V) and D40 (1.8V) should be light. The reset LED D18 should be off.

Additionally the LED D2 and D4 should be on. The starter kit is delivered with programmed Softune Workbench Monitor Debugger in internal Flash of MB91F467D series. The monitor debugger is checking also the external SRAM access at CS1. In case of successful access to external SRAM the LED D2 and D4 are ON. In case of failed access LED D1 and D4 are set to ON.

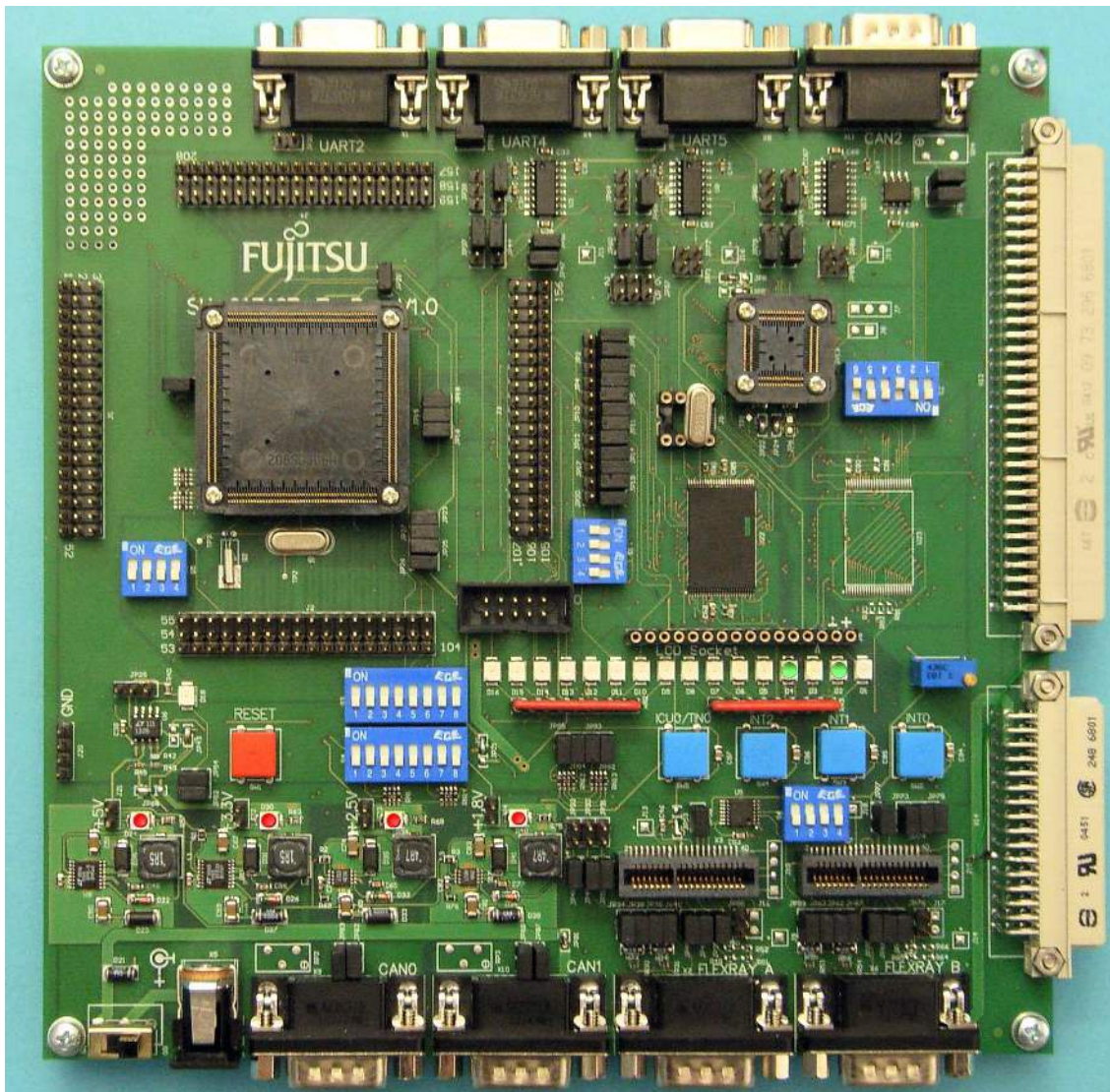

Figure 2-5: Starter kit status after power on

2.1 Jumper Settings

The following table lists all jumpers including its default setting and location on the starter kit. The default jumper setting is described for 16 bit non multiplexed bus communication between MCU and FlexRay CC.

Jumper	Description / Function	Type	Default	Layout Coordinates	Schematic Page
JP1	ASSP A10 / INT2	Jumper 3 pin	1-2	G 7	1 / 3
JP2	ASSP A9 / INT3	Jumper 3 pin	1-2	G 7	1 / 3
JP3	ASSP A5 / SCK	Jumper 3 pin	1-2	G 8	1 / 3
JP4	ASSP A4 / SDI	Jumper 3 pin	1-2	G 8	1 / 3
JP5	ASSP A3 / SDO	Jumper 3 pin	1-2	G 8	1 / 3
JP6	ASSP BCLK – MCU MCLKI	Solder Jumper 2 pad	Closed	K 9	1 / 3
JP7	ASSP – MCU A0 connection	Jumper 2 pin	Closed	B 8	1 / 3
JP8	ASSPVcc 5V / 3.3V	Solder Jumper 3 pad	1-2	J 6	1 / 3
JP9	ASSPVcc1 ASSPVcc / 3.3V	Solder Jumper 3 pad	1-2	J 6	1 / 3
JP10	ASSP D10 / MDS2	Jumper 3 pin	1-2	G 8	1 / 3
JP11	ASSP D9 / MDS1	Jumper 3 pin	1-2	G 9	1 / 3
JP12	ASSP D8 / MDS0	Jumper 3 pin	1-2	G 9	1 / 3
JP13	ASSP C-Pin – 1.8V	Solder Jumper 2 pad	Closed	K 8	1 / 3
JP14	ASSP D5 / INT2	Jumper 3 pin	1-2	G 9	1 / 3
JP15	MCUVcc - AVcc	Jumper 2 pin	Closed	E 9	1 / 3
JP16	AVcc - AVRH	Jumper 2 pin	Closed	E 9	1 / 3
JP17	ASSP D4 / INT3	Jumper 3 pin	1-2	G 10	1 / 3
JP18	GND - AVss	Jumper 2 pin	Closed	E 8	1 / 3
JP19	ASSP CS CSX3 / CSX6	Jumper 3 pin	1-2	G 10	1 / 3
JP20	ASSP ALE / INT2	Jumper 3 pin	1-2	G 10	1 / 3
JP21	VDD35 MCUVcc / 3.3V	Solder Jumper 3 pad	1-2	F 15	1 / 3
JP22	ASSP BGT – 1.8V	Solder Jumper 2 pad	Closed	J 9	1 / 3
JP23	MCUVcc – HVDD5	Jumper 2 pin	Closed	E 10	1 / 3
JP24	ASSP MT - GND	Solder Jumper 2 pad	Closed	K 9	1 / 3
JP25	MCUVcc – VDD5R	Jumper 2 pin	Closed	E 11	1 / 3
JP26	Vcc - MCUVcc	Jumper 2 pin	Closed	E 11	1 / 3
JP27	MCUVcc – VDD5	Jumper 2 pin	Closed	E 11	1 / 3
JP28	GND – HVSS5	Jumper 2 pin	Closed	E 6	1 / 3
JP29	DTR select DTR //DTR	Jumper 3 pin	Open	B 14	2 / 3
JP30	UART2 RTS - CTS	Jumper 2 pin	Open	D 3	2 / 3
JP31	FlexRay nSTB – P18_6	Jumper 2 pin	Open	G 16	2 / 3
JP32	FlexRay WAKE – P18_5	Jumper 2 pin	Open	G 16	2 / 3
JP33	FlexRay EN – P18_4	Jumper 2 pin	Open	G 16	2 / 3
JP34	FlexRay CHA RS485 Termination	Jumper 2 pin	Closed	H 18	2 / 3
JP35	FlexRay RxD_A	Jumper 2 pin	Closed	J 18	2 / 3
JP36	FlexRay CHA RS485 Termination	Jumper 2 pin	Closed	H 18	2 / 3
JP37	UART2 RxD RS232 / LIN	Jumper 3 pin	2-3	F 5	2 / 3
JP38	FlexRay CHA RS485 - BM	Jumper 2 pin	Closed	H 18	2 / 3
JP39	UART2 DTR / RTS	Jumper 3 pin	Open	F 4	2 / 3
JP40	FlexRay TxEN_A	Jumper 2 pin	Closed	J 18	2 / 3
JP41	FlexRay CHA RS485 - BP	Jumper 2 pin	Closed	H 18	2 / 3
JP42	Watch 1.8V	Solder Jumper 2 pad	Open	B 15	2 / 3
JP43	Watch 2.5V	Solder Jumper 2 pad	Closed	B 15	2 / 3
JP44	UART2 TxD RS232 / LIN	Jumper 3 pin	2-3	F 5	2 / 3
JP45	FlexRay TxD_A	Jumper 2 pin	Closed	H 18	2 / 3
JP46	UART2 RS232 / LIN	Jumper 3 pin	2-3	F 4	2 / 3
JP47	UART2 LIN Enable	Jumper 2 pin	Closed	G 6	2 / 3
JP48	FlexRay CHA EN	Jumper 2 pin	Closed	G 17	2 / 3
JP49	FlexRay CHA WAKE	Jumper 2 pin	Closed	G 17	2 / 3
JP50	FlexRay CHA nSTB	Jumper 2 pin	Closed	G 17	2 / 3
JP51	UART2 LIN Master Yes / No	Jumper 2 pin	Closed	G 5	2 / 3
JP52	RESET - ASSP RST	Jumper 2 pin	Closed	B 16	2 / 3
JP53	VccPL 5V / 3.3V	Solder Jumper 3 pad	1-2	H 16	2 / 3
JP54	RESET - MCU RST	Jumper 2 pin	Closed	B 15	2 / 3

Jumper	Description / Function	Type	Default	Layout Coordinates	Schematic Page
JP55	FlexRay CHA nERR – P14_4	Jumper 2 pin	Open	J 18	2 / 3
JP56	FlexRay CHA VBat	Jumper 2 pin	Closed	J 16	2 / 3
JP57	UARTX RST Select	Jumper 6 pin	Open	H 6	2 / 3
JP58	UART4 RTS - CTS	Jumper 2 pin	Closed	F 3	2 / 3
JP59	FlexRay CHB RS485 Termination	Jumper 2 pin	Closed	K 18	2 / 3
JP60	UART4 RxD RS232 / LIN	Jumper 3 pin	1-2	H 5	2 / 3
JP61	FlexRay RxD_B	Jumper 2 pin	Closed	L 18	2 / 3
JP62	FlexRay CHB RS485 Termination	Jumper 2 pin	Closed	K 18	2 / 3
JP63	FlexRay CHB RS485 - BM	Jumper 2 pin	Closed	K 18	2 / 3
JP64	UART4 DTR / RTS	Jumper 3 pin	Open	H 4	2 / 3
JP65	UART4 TxD RS232 / LIN	Jumper 3 pin	1-2	H 5	2 / 3
JP66	FlexRay TxEN_B	Jumper 2 pin	Closed	L 18	2 / 3
JP67	FlexRay CHB RS485 - BP	Jumper 2 pin	Closed	K 18	2 / 3
JP68	Vcc 5V / 3.3V	Solder Jumper 3 pad	1-2	B 16	2 / 3
JP69	UART4 RS232 / LIN	Jumper 3 pin	1-2	H 4	2 / 3
JP70	FlexRay TxD_B	Jumper 2 pin	Closed	L 18	2 / 3
JP71	UART4 LIN Enable	Jumper 2 pin	Open	H 6	2 / 3
JP72	UART4 LIN Master Yes / No	Jumper 2 pin	Open	H 6	2 / 3
JP73	FlexRay CHB EN	Jumper 2 pin	Closed	L 16	2 / 3
JP74	FlexRay CHB WAKE	Jumper 2 pin	Closed	L 16	2 / 3
JP75	FlexRay CHB nSTB	Jumper 2 pin	Closed	L 16	2 / 3
JP76	FlexRay CHB nERR – P14_7	Jumper 2 pin	Open	L 18	2 / 3
JP77	FlexRay CHB VBat	Jumper 2 pin	Closed	L 16	2 / 3
JP78	UART5 RTS - CTS	Jumper 2 pin	Closed	H 3	2 / 3
JP79	UART5 RxD RS232 / LIN	Jumper 3 pin	1-2	J 5	2 / 3
JP80	UART5 DTR / RTS	Jumper 3 pin	Open	J 4	2 / 3
JP81	UART5 TxD RS232 / LIN	Jumper 3 pin	1-2	K 5	2 / 3
JP82	CAN0 RxD	Jumper 2 pin	Closed	D 19	2 / 3
JP83	CAN0 TxD	Jumper 2 pin	Closed	D 19	2 / 3
JP84	UART5 RS232 / LIN	Jumper 3 pin	1-2	K 4	2 / 3
JP85	UART5 LIN Enable	Jumper 2 pin	Open	K 6	2 / 3
JP86	UART5 LIN Master Yes / No	Jumper 2 pin	Open	K 6	2 / 3
JP87	CAN1 RxD	Jumper 2 pin	Closed	G 19	2 / 3
JP88	CAN1 TxD	Jumper 2 pin	Closed	F 19	2 / 3
JP89	CAN2 RxD	Jumper 2 pin	Closed	M 4	2 / 3
JP90	CAN2 TxD	Jumper 2 pin	Closed	M 4	2 / 3
JP91	Vin – Ext Voltage	Solder Jumper 2 pad	Closed	G 18	3 / 3
JP92	INT0	Jumper 2 pin	Closed	G 15	3 / 3
JP93	INT1	Jumper 2 pin	Closed	G 15	3 / 3
JP94	INT2	Jumper 2 pin	Closed	G 15	3 / 3
JP95	ICU0/TIN0	Jumper 2 pin	Closed	G 15	3 / 3
JP96	Direct RESET	Solder Jumper 3 pad	1-2	A 14	2 / 3
JP97	VCC1V8 to X14B2	Solder Jumper 2 pad	Closed	H 16	3 / 3

Table 2-1: Jumper settings

2.2 Jumper Location

The following picture shows the silk plot of the starter kit with marked default jumper settings.

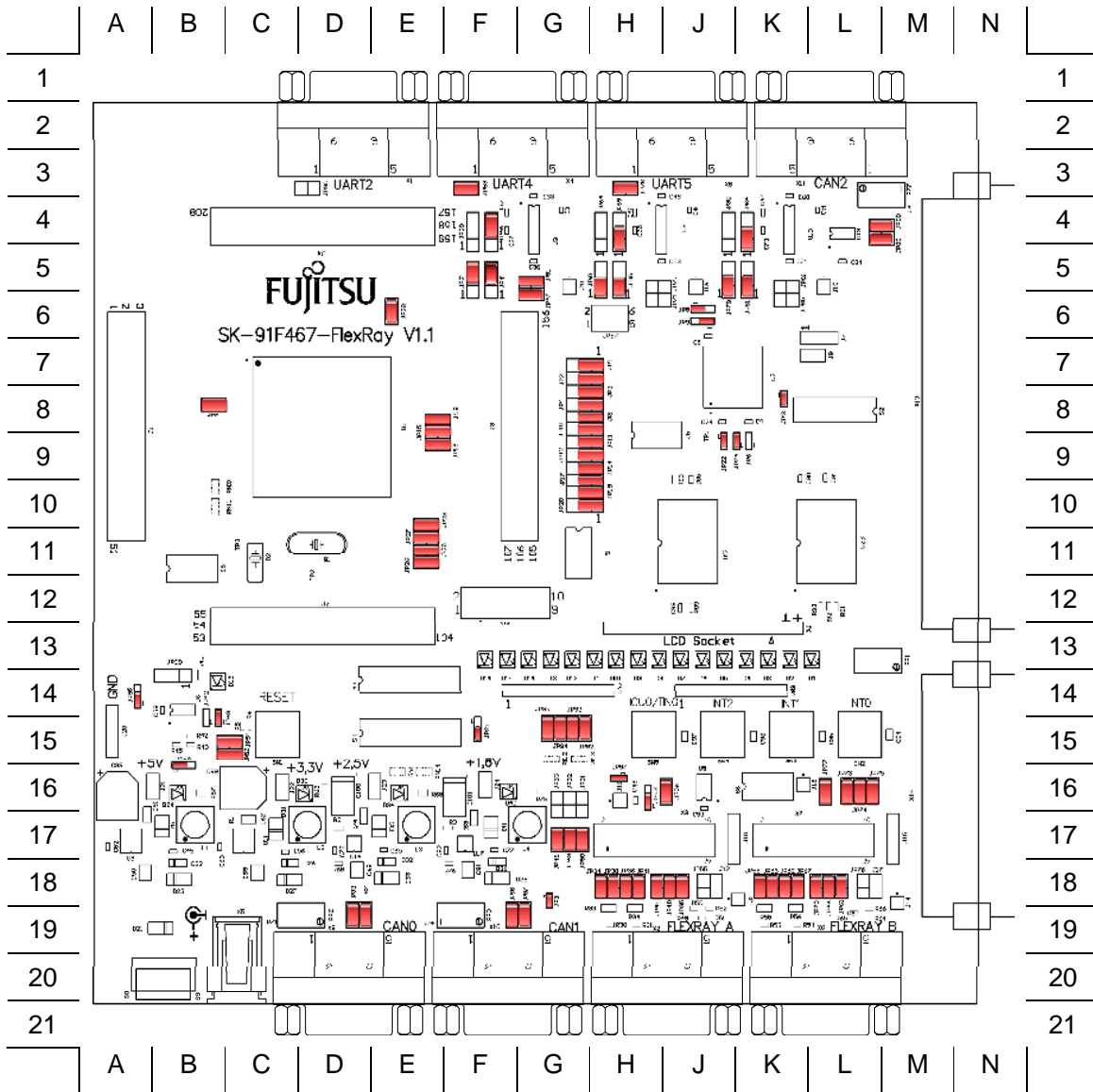

Figure 2-6: Default Jumper Settings

2.3 Software Installation

2.3.1 Installation of Softune Workbench

Fujitsu supplies a full working 32bit development environment with the “SK-91F467-FLEXRAY” starter kit called Softune Workbench V6. The Softune Workbench also supports a monitor debugger which is pre-programmed into the internal Flash memory of the “SK-91F467-FLEXRAY”. To develop own software and to work with the Monitor Debugger of the “SK-91F467-FLEXRAY” the Softune Workbench development environment must be installed first. Follow the instructions for successful installation of the Softune Workbench.

- 1) Before starting the installation setup ensure that you are logged in with administrator or power user permissions, otherwise the Softune installation will fail! Be aware that Softune does not support multi-user support. Therefore install- and user login must be the same.
- 2) Browse on the starter kit CD-ROM into the directory Software\SWBInstall and start the setup.exe
You can also start the installation using a browser by opening the index.html of the CD-ROM. Use the link “Software\Softune Workbench\” in the left side frame.
- 3) Follow the installation instructions
- 4) For the default installation path it is recommended to use c:\Softune32
- 5) After the installation is finished, Softune Workbench for FR can be started via the Windows “Start” menu



Figure 2-7: Softune Workbench start menu location

- 6) When Softune Workbench is started the following window will be shown

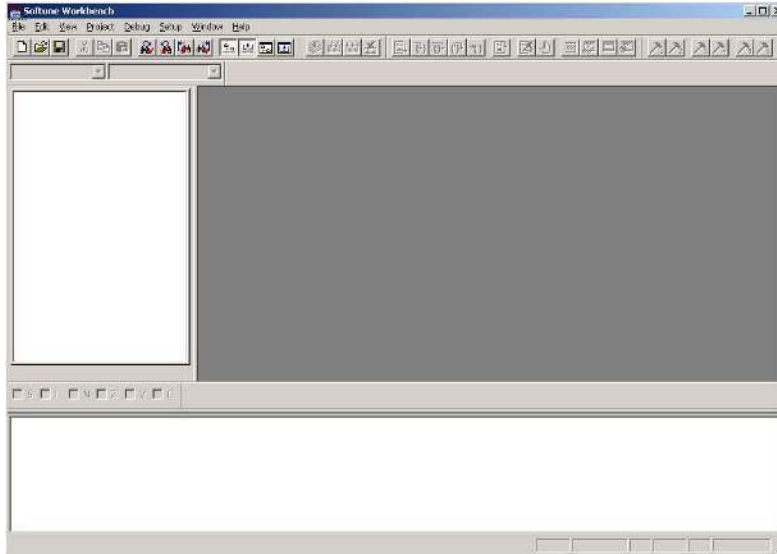

Figure 2-8: Softune Workbench V6 IDE

3 Jumpers and Switches

This chapter describes all jumpers and switches that can be modified on the starter kit. The default setting is shown with a grey shaded area.

3.1 MCU Operating-Mode (S5)

The DIP-switch S5 is used to set the operating mode of the MCU. Ensure that the mode pin settings correspond to the operation-mode of the application. For more detailed information please check the Hardware-Manual of the microcontroller.

DIP switch	Setting	Logical value
S5/1 (MD0)	ON (closed)	1 (high)
	OFF (open)	0 (low)
S5/2 (MD1)	ON (closed)	1 (high)
	OFF (open)	0 (low)
S5/3 (MD2)	ON (closed)	1 (high)
	OFF (open)	0 (low)
S5/4 (Not used)	ON (closed)	Not connected
	OFF (open)	Not connected
Default: grey		

Table 3-1: MCU Operating Mode

By default, the “Single Chip Run-Mode” of MB91F467DA is selected.

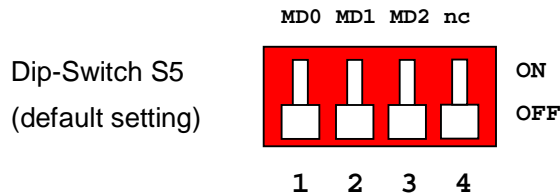

Figure 3-1: MCU Mode Switch

3.2 FlexRay CC Operating-Mode (S2)

The DIP-switch S2 is used to set the operating mode of the FlexRay communication controller. Ensure that the mode pin settings correspond to the operation-mode of the application. For more detailed information please check the Hardware-Manual of the FlexRay CC.

DIP switch	Setting	Logical value
S2/1 (MD0)	ON (closed)	0 (low)
	OFF (open)	1 (high)
S2/2 (MD1)	ON (closed)	0 (low)
	OFF (open)	1 (high)
S2/3 (MD2)	ON (closed)	0 (low)
	OFF (open)	1 (high)
S2/4 (MDE0)	ON (closed)	0 (low)
	OFF (open)	1 (high)
S2/5 (MDE1)	ON (closed)	0 (low)
	OFF (open)	1 (high)
S2/6 (MDE2)	ON (closed)	0 (low)
	OFF (open)	1 (high)
Default: grey		

Table 3-2: FlexRay CC Operating Mode

By default, the “16-bit non multiplexed mode” is selected.

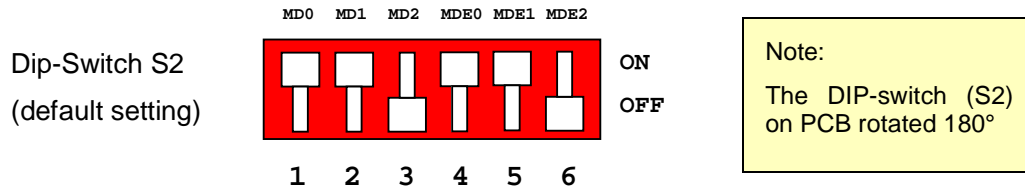

Figure 3-2: FlexRay CC Mode Switch

To set the operating mode to “16-bit multiplexed (FR 460) mode”, DIP S2 and some jumpers should be set as following:

For DIP S2: MD2 OFF, all others ON.

For JP1, 2 and 20: 2-3 closed; JP3, 4 and 5: open (no connection); JP10, 11, 12, 14, 17 and 19 remain default (1-2 closed).

3.3 FlexRay CC SPI Settings (S1)

The DIP-switch S1 is used to set the FlexRay CC SPI settings, if the FlexRay CC is selected to communicate with the MCU over SPI. For more detailed information please check the Hardware-Manual of the FlexRay CC.

Note:

The DIP-switch (S1) is connected to the FlexRay CC in case the jumpers setting are set to SPI communication mode. Please refer to chapter 3.5 MCU-FlexRay CC Connection.

DIP switch	Setting	Logical value
S1/1 (MDS0)	ON (closed)	0 (low)
	OFF (open)	1 (high)
S1/2 (MDS1)	ON (closed)	0 (low)
	OFF (open)	1 (high)
S1/3 (MDS2)	ON (closed)	0 (low)
	OFF (open)	1 (high)
S1/4 (Not used)	ON (closed)	Not connected
	OFF (open)	Not connected
Default: grey		

Table 3-3: FlexRay CC SPI Settings

The SPI function is not supported by MB88121 or MB88121A!

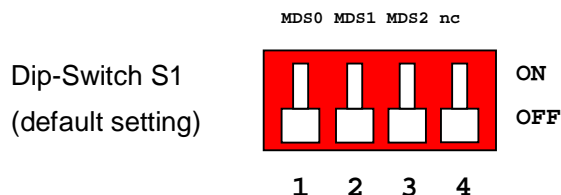

Figure 3-3: FlexRay CC SPI-Mode Switch

3.4 Power Supply

There are four on-board switching regulators to provide the voltages 5V, 3.3V, 2.5V and 1.8V on the starter-kit. With the power ON/OFF-switch S8 or S9 (S9 is a soldering option to use a different switch), the main input voltage from DC-connector X5 will be connected to the VIN voltage of the board. The VIN voltage supplies the switching regulators and the VBat voltage of the FlexRay physical layer driver modules from TZM (FT1080), if they are connected to X3 and X7.

Switch	Setting	Description
S8 or S9	ON (1-2)	Power ON
	OFF (2-3)	Power OFF
Default: grey		

Table 3-4: Power Switch

With JP91 the pins B14, B15 and B16 of the external bus interface connector X14 can be connected to the VIN voltage, so that it is possible to supply the board from an external connected board e.g. the Fujitsu FlexRay FPGA board.

There is a triple supply monitor on-board, which monitors three of the four DC output voltages and generates a system reset, in case with wrong levels of the on board voltages. 5V and 3.3V are always monitored and the third monitored voltage can be selected with the solder jumpers JP42 and JP43.

With JP68 it is possible to select the whole board supply voltage Vcc to 5V or 3.3V

Jumper	Setting	Description
JP91	ON (closed)	Vin connected to X14 pins B14, B15 and B16
	OFF (open)	Vin not connected to X14 pins B14, B15 and B16
JP42	ON (closed)	Vcc1V8 connected to supply monitor
	OFF (open)	Vcc1V8 not connected to supply monitor
JP43	ON (closed)	Vcc2V5 connected to supply monitor
	OFF (open)	Vcc2V5 not connected to supply monitor
JP68	1-2	Vcc is connected to 5V
	2-3	Vcc is connected to 3.3V
Default: grey		

Table 3-5: Power supply configurations

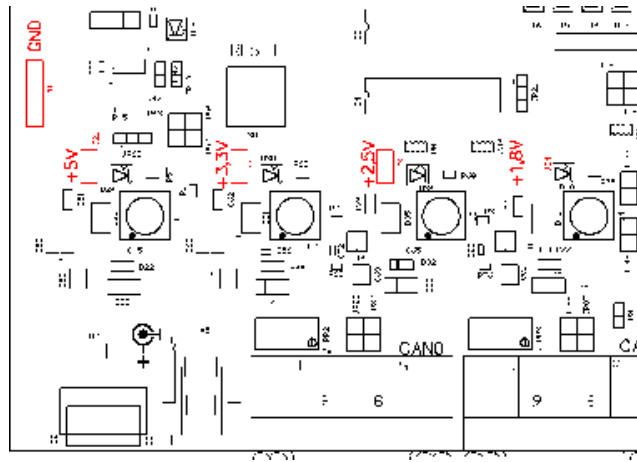

Figure 3-4: Voltage Test Points

Regulator	Test point	Voltage
U9	J21	+5V
U11	J22	+3.3V
U14	J23	+2.5V
U17	J24	+1.8V
-	J20	GND

Table 3-6: Voltage Test Points

3.4.1 MCU Power Supply Voltage

- JP21** With this jumper it is possible to connect the MCU external bus interface supply VDD35 to 3.3V. The MCU MB91460 series supports the function to supply the MCU with 5V so that the normal I/O ports work with 5V and supply the external bus interface with 3.3V.
- JP23** This jumper is used to connect the HVDD5 supply to MCUVcc. The HVDD5 is the MCU supply voltage for the high current ports.
- JP25** This jumper is used to connect the VDD5R MCU supply pins to MCUVcc
- JP26** This jumper is used to connect the Vcc voltage to MCUVcc.
- JP27** This jumper is used to connect the VDD5 MCU supply pins to MCUVcc
- JP28** This jumper is used to connect the HVSS5 MCU pins to GND. HVSS5 are the GND pins for the high current ports.

Note:

JP23, JP25, JP26, JP27 and JP28 can be used for measurements of power consumption of the MCU.

Jumper	Setting	Description
JP21	1-2	VDD35 connected to MCUVcc
	2-3	VDD35 connected to 3.3V
JP23	ON (closed)	HVDD5 connected to MCUVcc
	OFF (open)	HVDD5 not connected to MCUVcc
JP25	ON (closed)	VDD5R connected to MCUVcc
	OFF (open)	VDD5R not connected to MCUVcc
JP26	ON (closed)	MCUVcc connected to Vcc
	OFF (open)	MCUVcc not connected to Vcc
JP27	ON (closed)	VDD5 connected to MCUVcc
	OFF (open)	VDD5 not connected to MCUVcc
JP28	ON (closed)	HVSS5 connected to GND
	OFF (open)	HVSS5 not connected to GND
Default: grey		

Table 3-7: MCU Power Supply SK-91F467-FLEXRAY

3.4.2 MCU Analogue Power Supply Voltage

The power supply as well as the reference voltage for the A/D-converter can be provided internally or externally.

- JP15** Connects power supply AVcc of the A/D converter to MCUVcc
- JP16** Connects high reference voltage AVRH of the A/D converter to AVcc
- JP18** Connects AVss of the A/D converter to GND

Jumper	Setting	Description
JP15	ON (closed)	AVcc is connected to MCUVcc
	OFF (open)	AVcc is disconnected
JP16	ON (closed)	AVRH is connected to AVcc
	OFF (open)	AVRH defined by resistor network ^{*1}
JP18	ON (closed)	AVss is connected to GND
	OFF (open)	AVss is disconnected
Default: grey		

^{*1}By default the resistor network (R10 and R13) is not assembled on the board

Table 3-8: MCU ADC Supply

Note:
If JP15 or JP18 are open, the user has to supply an adequate analogue voltage supply (AVcc and AVss) to the A/D-converter.
If JP16 is open, the potential divider comprising resistors R10 and R13 define AVRH.

3.4.3 FlexRay CC Power Supply Voltage at SK-91F467-FLEXRAY

JP8 Connects 5V or 3.3V voltage supply to ASSPVcc

JP9 Connects 3.3V or ASSPVcc to ASSP voltage supply pin Vcc1 (3.3V by default)

JP13 Connects ASSP C-pin to 1.8V voltage supply

JP22 Connects ASSP pin 8 to 1.8V voltage supply

JP24 Connects ASSP pin 9 to GND

Jumper	Setting	Description
JP8	1-2	5V connected to ASSPVcc
	2-3	3.3V connected to ASSPVcc
JP9	1-2	3.3V connected to ASSP Vcc1 pin
	2-3	ASSPVcc connected to ASSP Vcc1 pin
JP13	ON (closed)	1.8V connected to ASSP C-pin
	OFF (open)	1.8V not connected to ASSP C-pin
JP22	ON (closed)	1.8V connected to ASSP pin 8
	OFF (open)	1.8V not connected to ASSP pin 8
JP24	ON (closed)	GND connected to ASSP pin 9
	OFF (open)	GND not connected to ASSP pin 9
Default: grey		

Table 3-9: FlexRay CC Supply

3.4.4 Change FlexRay CC Power supply to MB88121B

The first production slots of SK-91F467-FLEXRAY starter kit support MB88121A series.

This series must be supplied with three voltages (5V, 3.3V and 1.8V).

Using the MB88121B series the power supply settings needs to be changed due to single voltage supply.

Solder Jumper JP13, JP22, JP24 must be opened.

Solder Jumper JP9 must be changed to position 2-3.

Jumper	Setting	Description
JP8	1-2	5V connected to ASSPVcc
	2-3	3.3V connected to ASSPVcc
JP9	1-2	3.3V connected to ASSP Vcc1 pin
	2-3	ASSPVcc connected to ASSP Vcc1 pin
JP13	ON (closed)	1.8V connected to ASSP C-pin
	OFF (open)	1.8V not connected to ASSP C-pin
JP22	ON (closed)	1.8V connected to ASSP pin 8
	OFF (open)	1.8V not connected to ASSP pin 8
JP24	ON (closed)	GND connected to ASSP pin 9
	OFF (open)	GND not connected to ASSP pin 9
Default: grey		
MB88121B Jumper settings: orange		

Table 3-10: Power Supply settings for MB88121B

3.5 MCU-FlexRay CC Connection at SK-91F467-FLEXRAY

The FlexRay communication controller MB88121 provides different communication modes to a microcontroller. The MB88121 has different pin functions in its communication modes. Therefore it is possible to connect the CC in different ways to the MCU, to evaluate the different communication modes.

- JP1** Connects MCU INT6 or MCU A10 to CC pin 35 (INT2 / A10)
- JP2** Connects MCU INT7 or MCU A9 to CC pin 36 (INT3 / A9)
- JP3** Connects MCU A5 or MCU SCK6 to CC pin 40 (SCK / A5)
- JP4** Connects MCU A4 or MCU SOT6 to CC pin 41 (SDI / A4)
- JP5** Connects MCU A3 or MCU SIN6 to CC pin 42 (SDO / A3)
- JP7** Connects MCU A0 with CC A0
- JP10** Connects MCU D26 or CC SPI-mode switch S1-3 (MDS2) to CC pin 53 (AD10 / D10 / AD2 / D2 / MDS2)
- JP11** Connects MCU D25 or CC SPI-mode switch S1-2 (MDS1) to CC pin 54 (AD9 / D9 / AD1 / D1 / MDS1)
- JP12** Connects MCU D24 or CC SPI-mode switch S1-1 (MDS0) to CC pin 55 (AD8 / D8 / AD0 / D0 / MDS0)
- JP14** Connects MCU D21 or MCU INT6 to CC pin 58 (AD5 / INT2)
- JP17** Connects MCU D20 or MCU INT7 to CC pin 59 (AD4 / INT3)
- JP19** Connects MCU CSX3 or MCU CSX6 to CC pin 19 (CS)
- JP20** Connects MCU INT6 or MCU ASX to CC pin 22 (ALE / INT2)

Note:

For more information about the FlexRay CC modes and the different pin functions, please refer to MB88121 documentation.

Jumper	Setting	Description
JP1	1-2	MCU INT6 connected to CC INT2
	2-3	MCU A10 connected to CC A10
JP2	1-2	MCU INT7 connected to CC INT3
	2-3	MCU A9 connected to CC A9
JP3	1-2	MCU A5 connected to CC A5
	2-3	MCU SCK6 connected to CC SCK
JP4	1-2	MCU A4 connected to CC A4
	2-3	MCU SOT6 connected to CC SDI
JP5	1-2	MCU A3 connected to CC A3
	2-3	MCU SIN6 connected to CC SDO
JP7	ON (closed)	MCU A0 is connected to CC A0
	OFF (open)	MCU A0 is not connected to CC A0
JP10	1-2	MCU D26 connected to CC AD2 / AD10

Jumper	Setting	Description
	2-3	CC SPI-mode switch S1-3 connected to CC MDS2
JP11	1-2	MCU D25 connected to CC AD1 / AD9
	2-3	CC SPI-mode switch S1-2 connected to CC MDS1
JP12	1-2	MCU D24 connected to CC AD0 / AD8
	2-3	CC SPI-mode switch S1-1 connected to CC MDS0
JP14	1-2	MCU D21 connected to CC AD5
	2-3	MCU INT6 connected to CC INT2
JP17	1-2	MCU D20 connected to CC AD4
	2-3	MCU INT7 connected to CC INT3
JP19	1-2	MCU CSX3 connected to CC CS
	2-3	MCU CSX6 connected to CC CS
JP20	1-2	MCU INT6 connected to CC INT2
	2-3	MCU ASX connected to CC ALE
Default: grey		

Table 3-11: MCU-FlexRay CC Connection

3.6 FlexRay Physical Layer

The SK-91F467-FLEXRAY provides different FlexRay physical layer communication. The default setting is for RS-485 physical layer communication (on board). To test the original FlexRay physical layer transceiver, it is possible to deselect the RS-485 transceiver and plug in FlexRay physical layer driver module from TZM (FT1080). With the TZM (FT1080) modules the user has the possibility to evaluate transceiver chips from different vendors quite easy.

Note:

Disconnect the RS-485 physical layer transceiver signals before plugging in the FT1080 modules to X3 and X7.

3.6.1 Channel A

- JP35** Connects FlexRay channel A RxD to RS-485 transceiver (FT1080 must not be plugged in X3!)
- JP40** Connects FlexRay channel A TxEN to RS-485 transceiver (FT1080 must not be plugged in X3!)
- JP45** Connects FlexRay channel A TxD to RS-485 transceiver (FT1080 must not be plugged in X3!)
- JP38** Connects FlexRay channel A RS-485 transceiver output B to Sub-D-9 connector (X2)
- JP41** Connects FlexRay channel A RS-485 transceiver output A to Sub-D-9 connector (X2)
- JP34, JP36** Connects RS-485 termination network to signal lines at FlexRay channel A
- JP48** Connects FT1080 module CH-A EN to configuration switch S6

- JP49** Connects FT1080 module CH-A WAKE to configuration switch S6
- JP50** Connects FT1080 module CH-A nSTB to configuration switch S6
- JP55** Connects FT1080 module CH-A nERR to MCU port P14_4
- JP53** Selects VccPL (supply voltage of CH-A and CH-B FT1080 modules) 3.3V or 5V
- JP56** Connects FT1080 module CH-A VBat to VBat (input voltage of the starter kit)

Jumper	Setting	Description
JP35	ON (closed)	RXDA connected to RS-485 transceiver
	OFF (open)	RXDA not connected to RS-485 transceiver
JP40	ON (closed)	TXENA connected to RS-485 transceiver
	OFF (open)	TXENA not connected to RS-485 transceiver
JP45	ON (closed)	TXDA connected to RS-485 transceiver
	OFF (open)	TXDA not connected to RS-485 transceiver
JP38	ON (closed)	CH-A RS-485 output B connected to X2
	OFF (open)	CH-A RS-485 output B not connected to X2
JP41	ON (closed)	CH-A RS-485 output A connected to X2
	OFF (open)	CH-A RS-485 output A not connected to X2
JP34, JP36	ON (closed)	Line termination connected to CH-A RS-485
	OFF (open)	Line termination not connected to CH-A RS-485
JP48	ON (closed)	CH-A FT1080 EN connected to S6
	OFF (open)	CH-A FT1080 EN connected to S6
JP49	ON (closed)	CH-A FT1080 WAKE connected to S6
	OFF (open)	CH-A FT1080 WAKE connected to S6
JP50	ON (closed)	CH-A FT1080 nSTB connected to S6
	OFF (open)	CH-A FT1080 nSTB connected to S6
JP55	ON (closed)	CH-A FT1080 nERR connected to MCU P14_4
	OFF (open)	CH-A FT1080 nERR not connected to MCU P14_4
JP53	1-2	Vcc 5V is connected to VccPL
	2-3	Vcc 3.3V is connected to VccPL
JP56	ON (closed)	VBat is connected to FT1080 CH-A
	OFF (open)	VBat is not connected to FT1080 CH-A
Default: grey		

Table 3-12: FlexRay CH-A Configuration

3.6.2 Channel B

- JP61** Connects FlexRay channel B RxD to RS-485 transceiver (FT1080 must not be plugged in X7!)
- JP66** Connects FlexRay channel B TxEN to RS-485 transceiver (FT1080 must not be plugged in X7!)
- JP70** Connects FlexRay channel B TxD to RS-485 transceiver (FT1080 must not be plugged in X7!)

- JP63** Connects FlexRay channel B RS-485 transceiver output B to Sub-D-9 connector (X6)
- JP67** Connects FlexRay channel B RS-485 transceiver output A to Sub-D-9 connector (X6)
- JP59, JP62** Connects RS-485 termination network to signal lines at FlexRay channel B
- JP73** Connects FT1080 module CH-B EN to configuration switch S6
- JP74** Connects FT1080 module CH-B WAKE to configuration switch S6
- JP75** Connects FT1080 module CH-B nSTB to configuration switch S6
- JP76** Connects FT1080 module CH-B nERR to MCU port P14_7
- JP77** Connects FT1080 module CH-B VBat to VBat (input voltage of the starter kit)

Jumper	Setting	Description
JP61	ON (closed)	RXDB connected to RS-485 transceiver
	OFF (open)	RXDB not connected to RS-485 transceiver
JP66	ON (closed)	TXENB connected to RS-485 transceiver
	OFF (open)	TXENB not connected to RS-485 transceiver
JP70	ON (closed)	TXDB connected to RS-485 transceiver
	OFF (open)	TXDB not connected to RS-485 transceiver
JP63	ON (closed)	CH-B RS-485 output B connected to X6
	OFF (open)	CH-B RS-485 output B not connected to X6
JP67	ON (closed)	CH-B RS-485 output A connected to X6
	OFF (open)	CH-B RS-485 output A not connected to X6
JP59, JP62	ON (closed)	Line termination connected to CH-B RS-485
	OFF (open)	Line termination not connected to CH-B RS-485
JP73	ON (closed)	CH-B FT1080 EN connected to S6
	OFF (open)	CH-B FT1080 EN connected to S6
JP74	ON (closed)	CH-B FT1080 WAKE connected to S6
	OFF (open)	CH-B FT1080 WAKE connected to S6
JP75	ON (closed)	CH-B FT1080 nSTB connected to S6
	OFF (open)	CH-B FT1080 nSTB connected to S6
JP76	ON (closed)	CH-B FT1080 nERR connected to MCU P14_7
	OFF (open)	CH-B FT1080 nERR not connected to MCU P14_7
JP77	ON (closed)	VBat is connected to FT1080 CH-B
	OFF (open)	VBat is not connected to FT1080 CH-B
Default: grey		

Table 3-13: FlexRay CH-B Configuration

3.6.3 FT1080 Control Settings (S6)

The DIP switch S6 is used to set EN, WAKE and nSTB signals of the FlexRay physical layer driver modules from TZM (FT1080). The control signals can also be connected with jumper to the MCU to give the possibility to set them via user software. Both modules (FT1080) will be set simultaneously, if JP48-JP50 and JP73-JP75 are closed.

DIP switch	Setting	Logical value
S6/1 (EN)	ON (closed)	0 (low)
	OFF (open)	1 (high)
S6/2 (WAKE)	ON (closed)	0 (low)
	OFF (open)	1 (high)
S6/3 (nSTB)	ON (closed)	0 (low)
	OFF (open)	1 (high)
S6/4 (Not used)	ON (closed)	Not connected
	OFF (open)	Not connected

Default: grey

Table 3-14: FT1080 Control Settings

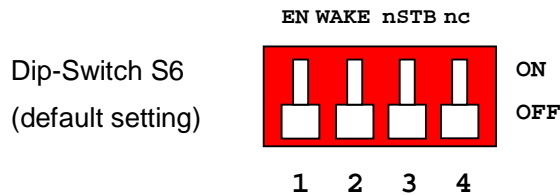

Figure 3-5: FT1080 Control Switch

JP31 Connects nSTB signal of FT1080 modules to MCU port 18_6

JP32 Connects WAKE signal of FT1080 modules to MCU port 18_5

JP33 Connects EN signal of FT1080 modules to MCU port 18_4

Jumper	Setting	Description
JP31	ON (closed)	nSTB is connected to MCU P18_6
	OFF (open)	No connection to the microcontroller
JP32	ON (closed)	WAKE is connected to MCU P18_5
	OFF (open)	No connection to the microcontroller
JP33	ON (closed)	EN is connected to MCU P18_4
	OFF (open)	No connection to the microcontroller

Default: grey

Table 3-15: FT1080 Connection to MCU

3.7 CAN0 – CAN2

Three high-speed CAN-transceivers (PCA82C250) are on-board to connect all available on-chip CAN to 9-pin D-Sub connectors (X9, X10 and X11).

JP82 Connects MCU RX0 to CAN transceiver U15

JP83 Connects MCU TX0 to CAN transceiver U15

JP87 Connects MCU RX1 to CAN transceiver U18

JP88 Connects MCU TX1 to CAN transceiver U18

JP89 Connects MCU RX2 to CAN transceiver U19

JP90 Connects MCU TX2 to CAN transceiver U19

Jumper	Setting	Description
JP82	ON (closed)	CAN0 RxD connected to MCU
	OFF (open)	No connection to the microcontroller
JP83	ON (closed)	CAN0 TxD connected to MCU
	OFF (open)	No connection to the microcontroller
JP87	ON (closed)	CAN1 RxD connected to MCU
	OFF (open)	No connection to the microcontroller
JP88	ON (closed)	CAN1 TxD connected to MCU
	OFF (open)	No connection to the microcontroller
JP89	ON (closed)	CAN2 RxD connected to MCU
	OFF (open)	No connection to the microcontroller
JP90	ON (closed)	CAN2 TxD connected to MCU
	OFF (open)	No connection to the microcontroller
Default: grey		

Table 3-16: CAN-MCU connection

3.8 LIN / RS-232 UART

There are three UART connectors X1, X4 and X8 (9-pin D-Sub) on-board, which can be used for RS-232 or LIN communication (to get information in detail about pin usage, please refer to chapter 4.2 UART / LIN Connector (X1, X4, X8)). The LIN transceiver needs to be configured as LIN-master or LIN-slave.

3.8.1 UART 2

UART2 (connector X1) is selected as LIN master at default setting.

JP37 Select, if SIN2 is connected to RS-232- or LIN-transceiver

JP44 Select, if SOT2 is connected to RS-232- or LIN-transceiver

JP46 Select, if RS-232- or LIN-transceiver is connected to X1 pin2 (shared pin)

JP30 Some terminal programs needs a connection between CTS and RTS

JP39 Selects, if DTR or RTS will be used for system reset generation

JP47 Enables the LIN transceiver

JP51 Selects, if UART2 will be LIN master or LIN slave

Note:
UART2 has to be selected with JP57, to generates a system reset

Jumper	Setting	Description
JP37	1-2	MCU SIN2 connected to RS-232 transceiver
	2-3	MCU SIN2 connected to LIN transceiver
JP44	1-2	MCU SOT2 connected to RS-232 transceiver
	2-3	MCU SOT2 connected to LIN transceiver
JP46	1-2	X1 pin2 is connected to RS-232 transceiver
	2-3	X1 pin2 is connected to LIN transceiver
JP30	ON (closed)	RTS and CTS is connected at connector X1
	OFF (open)	RTS and CTS is not connected at connector X1
JP39	1-2	DTR can be used for system reset
	2-3	RTS can be used for system reset
JP47	ON (closed)	LIN transceiver is enabled
	OFF (open)	LIN transceiver is not enabled
JP51	ON (closed)	LIN master mode
	OFF (open)	LIN slave mode
Default: grey		

Table 3-17: UART2 Settings

3.8.2 UART 4 (Flash programming)

UART4 (connector X4) is selected as RS-232 at default setting. UART4 is also used to write user software into the Flash of the MCU.

JP60 Select, if SIN4 is connected to RS-232- or LIN-transceiver

JP65 Select, if SOT4 is connected to RS-232- or LIN-transceiver

JP69 Select, if RS-232- or LIN-transceiver is connected to X4 pin2 (shared pin)

JP58 Some terminal programs needs a connection between CTS and RTS

JP64 Selects, if DTR or RTS will be used for system reset generation

JP71 Enables the LIN transceiver

JP72 Selects, if UART4 will be LIN master or LIN slave

Note:

UART4 has to be selected with JP57, to generates a system reset

Jumper	Setting	Description
JP60	1-2	MCU SIN4 connected to RS-232 transceiver
	2-3	MCU SIN4 connected to LIN transceiver
JP65	1-2	MCU SOT4 connected to RS-232 transceiver
	2-3	MCU SOT4 connected to LIN transceiver
JP69	1-2	X4 pin2 is connected to RS-232 transceiver
	2-3	X4 pin2 is connected to LIN transceiver
JP58	ON (closed)	RTS and CTS is connected at connector X4
	OFF (open)	RTS and CTS is not connected at connector X4
JP64	1-2	DTR can be used for system reset
	2-3	RTS can be used for system reset
JP71	ON (closed)	LIN transceiver is enabled
	OFF (open)	LIN transceiver is not enabled
JP72	ON (closed)	LIN master mode
	OFF (open)	LIN slave mode

Default: grey

Table 3-18: UART4 Settings

Note:

UART4 is used as serial interface for Softune Workbench Monitor Debugger. Jumper J58 must be closed.

3.8.3 UART 5

UART5 (connector X8) is selected as RS-232 at default setting.

JP79 Select, if SIN5 is connected to RS-232- or LIN-transceiver

JP81 Select, if SOT5 is connected to RS-232- or LIN-transceiver

JP84 Select, if RS-232- or LIN-transceiver is connected to X8 pin2 (shared pin)

JP78 Some terminal programs needs a connection between CTS and RTS

JP80 Selects, if DTR or RTS will be used for system reset generation

JP85 Enables the LIN transceiver

JP86 Selects, if UART5 will be LIN master or LIN slave

Note:
UART5 has to be selected with JP57, to generates a system reset

Jumper	Setting	Description
JP79	1-2	MCU SIN4 connected to RS-232 transceiver
	2-3	MCU SIN4 connected to LIN transceiver
JP81	1-2	MCU SOT4 connected to RS-232 transceiver
	2-3	MCU SOT4 connected to LIN transceiver
JP84	1-2	X4 pin2 is connected to RS-232 transceiver
	2-3	X4 pin2 is connected to LIN transceiver
JP78	ON (closed)	RTS and CTS is connected at connector X4
	OFF (open)	RTS and CTS is not connected at connector X4
JP80	1-2	DTR can be used for system reset
	2-3	RTS can be used for system reset
JP85	ON (closed)	LIN transceiver is enabled
	OFF (open)	LIN transceiver is not enabled
JP86	ON (closed)	LIN master mode
	OFF (open)	LIN slave mode
Default: grey		

Table 3-19: UART5 Settings

3.9 User Push Buttons INT0, INT1, INT2 and ICU0/TIN0

There are four user push buttons on the starter kit, which can be connected to the microcontroller.

JP92 – JP95 Connects the user push buttons (SW2 – SW5) to the microcontroller

Jumper	Setting	Description
JP92 (SW2)	ON (closed)	Button INT0 is connected to the microcontroller
	OFF (open)	No connection to the microcontroller
JP93 (SW3)	ON (closed)	Button INT1 is connected to the microcontroller
	OFF (open)	No connection to the microcontroller
JP94 (SW4)	ON (closed)	Button INT2 is connected to the microcontroller
	OFF (open)	No connection to the microcontroller
JP95 (SW5)	ON (closed)	Button ICU0/TIN0 is connected to the microcontroller
	OFF (open)	No connection to the microcontroller
Default: grey		

Table 3-20: User Push Buttons

3.10 User DIP Switch 8 Bit (S4)

There is an 8 bit user-DIP-switch on-board, which can be connected to one MCU port (P26), Connecting High- or Low level to the pins. S3, also an 8 bit DIP-switch, dis-/connect the eight channels of S4 to the MCU pins. In case of other usage of these pins, open S3 switch accordingly.

DIP switch	Setting	Logical value
S4/1 - 8	ON (closed)	0 (low)
	OFF (open)	1 (high)
Default: grey		

Table 3-21: S4 Values

Note:
 DIP-switch S3 is used to connect DIP-switch S4 to the MCU port pins at port P26.

DIP switch	Setting	Description
S3/1 - 8	ON (closed)	S4/1-8 connected to MCU port P26_0-7
	OFF (open)	No connection to the microcontroller
Default: grey		

Table 3-22: S3 Settings

3.11 Reset Generation

A system reset can be generated in different ways. The first possibility is to press the user reset push button (SW1). Secondly the supply monitor will generate a reset if an unusual voltage is detected and third a reset is raised if a UART that does a reset is selected.

If a system reset is done, it will be displayed by the red reset LED (D18).

The system reset will do a simultaneous reset of the microcontroller and the FlexRay communication controller. The MCU and / or the FlexRay CC can be disconnected from the system reset signal with two jumpers.

The Reset push button can be used in two modes:

- no delay of Reset
- press Reset button 2s

The selection is done by solder Jumper JP96.

JP52 Connects the FlexRay CC to the system reset signal (SK91F467-FLEXRAY)

JP54 Connects the MCU to the system reset signal

Jumper	Setting	Description
JP52	ON (closed)	Reset is connected to FlexRay CC RST
	OFF (open)	No connection to the FlexRay CC
JP54	ON (closed)	Reset is connected to MCU INITX
	OFF (open)	No connection to the MCU
JP96	1-2	Reset is generated when SW1 is pressed
	2-3	Reset is generated after SW1 is pressed 2s
Default: grey		

Table 3-23: Reset Connections

The triple supply monitor on-board has the possibility to watch 5V, 3.3V and the third voltage is user configurable 2.5V or 1.8V. If any voltage has a failure, a system reset will be done.

JP42 Monitoring of 1.8V supply voltage

JP43 Monitoring of 2.5V supply voltage

Jumper	Setting	Description
JP42	ON (closed)	Vcc1V8 connected to supply monitor
	OFF (open)	Vcc1V8 not connected to supply monitor
JP43	ON (closed)	Vcc2V5 connected to supply monitor
	OFF (open)	Vcc2V5 not connected to supply monitor
Default: grey		

Table 3-24: Supply Monitor Settings

By default 2.5V supply will be monitored.

The system reset also can be done via any UART. Therefore the user has the possibility to select one of the three on-board UARTs.

JP57 Select which UART should do the system reset

JP29 The polarity of the DTR/RTS signal can be inverted by this jumper. Remove the jumper to disable the UART reset function

Jumper	Setting	Description
JP57	1-2	Reset will be done via UART2
	3-4	Reset will be done via UART4
	5-6	Reset will be done via UART5
JP29	1-2	No polarity inversion for the DTR/RTS signal
	2-3	Polarity inversion for the DTR/RTS signal

Table 3-25: Reset UART Selection

By default the UART reset is disabled.

Note:

During normal operation, the reset LED should be off!

If the reset LED is steadily on, check the power supply voltages and the settings for the reset generation by UART.

4 Connectors

4.1 Power Connector (X5)

The following figure shows the power connection jack of the starter kit. This connector is used to connect an external unregulated DC power supply voltage (9V-12V DC recommended 2000mA).

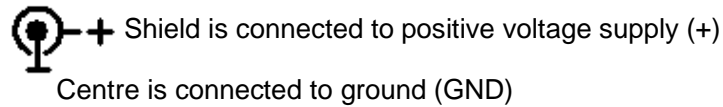

Table

Figure 4-1: Power Connector

4.2 UART / LIN Connector (X1, X4, X8)

Three 9-pin D-Sub female connectors are used for the serial interfaces LIN/UART2, LIN/UART4 and LIN/UART5.

Take care, that the RS232 as well as the LIN signals are shared at the connectors and have to be selected by jumpers (see chapter 3.8).

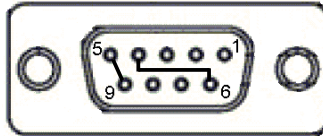

Figure 4-2: UART Connector

Pin Number	Pin Signal	Description
1	+VBat	Power from LIN bus
2	TXD	RS-232 transmit output
	LIN	Bi-directional LIN-interface
3	RXD	RS-232 receive input
4	DTR	Connected to DSR (pin 6)
5	GND	Ground normally used for RS232 connection
6	DSR	Connected to DTR (pin 4)
7	RTS	Can be connected with CTS by jumper
8	CTS	Can be connected with RTS by jumper
9	LGND	Ground normally used for LIN connection
Shield	GND	Ground

Table 4-1: UART Connector Signals

Note:
Please use 1:1 cable for RS232 PC-connection.

4.3 CAN Connector (X9, X10, X11)

Three 9-pin D-Sub male connectors are used for the CAN interfaces CAN0, CAN1 and CAN2.

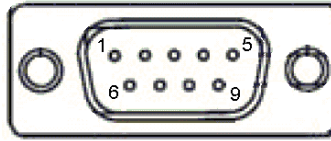

Figure 4-3: CAN Connector

Pin Number	Pin Signal	Description
1	NC	Not used
2	CANL	LOW-level CAN voltage input/output
3	GND	Ground
4	NC	Not used
5	NC	Not used
6	NC	Not used
7	CANH	HIGH-level CAN voltage input/output
8	NC	Not used
9	NC	Not used
Shield	GND	Ground

Table 4-2: CAN Connector Signals

4.4 FlexRay Connector (X2, X6)

Two 9-pin D-Sub male connectors are used for the two FlexRay channels A and B. As default RS-485 is used at SK-91F467-FLEXRAY.

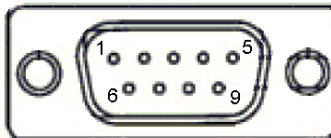

Figure 4-4: FlexRay Connector

Pin Number	Pin Signal	Description
1	NC	Not used
2	BM	Bus line Minus
3	GND	Ground
4	NC	Not used
5	User	Connected to optional pin head (CH-A: J9; CH-B: J14)
6	NC	Not used
7	BP	Bus line Plus
8	NC	Not used
9	NC	Not used
Shield	Shield	Connected to shield of FT1080 modules

Table 4-3: FlexRay Connector Signals

4.5 FlexRay Physical Layer Module Connector (X3, X7)

To use the FlexRay physical layer driver module from TZM (FT1080) there are two special connectors on board of SK-91F467-FLEXRAY, both for FlexRay channels A and B, to insert the modules. If the modules FT1080 should be used, it is necessary to disable the RS-485 driver modules (see chapter 3.6).

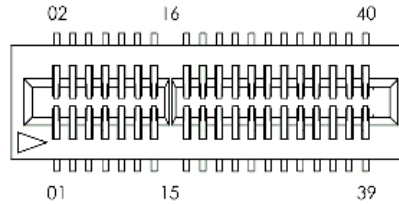

Figure 4-5: FlexRay Physical Layer Connector

Pin Number	Pin Signal	Description
1	SGND	Signal Ground
2	Shield	FlexRay bus shield (filtered)
3	NC	Not used
4	BM	Bus line Minus
5	NC	Not used
6	BP	Bus line Plus
7	EN	Mode control input
8	NC	Not used
9	WAKE	Local wakeup
10	NC	Not used
11	nSTB	Mode control input
12	NC	Not used
13	BGE	Bus guardian enable
14	NC	Not used
15	No Pin	Coded
16	No Pin	Coded
17	TxD	Transmission data input
18	Ubuffer	Transmitter supply voltage buffering
19	TxEN	Transmission data enable
20	GND	Ground
21	RxD	Receive data output
22	VIO	I/O supply voltage
23	RxEN	Receive data enable output (not used)
24	GND	Ground
25	INH2	Inhibit switch floating in standby / sleep mode
26	Vcc	Supply voltage
27	INH1	Inhibit switch floating in sleep mode
28	GND	Ground
29	nERR	Error indication
30	VBat	Battery supply voltage
31	NC	Not used
32	GND	Ground
33	NC	Not used
34	nCS	ID-EEPROM SPI-nCS (connected to optional pin header)
35	NC	Not used
36	SDI	ID-EEPROM SPI data in (connected to optional pin header)
37	TRXD0	Star (connected to optional pin header)
38	SDO	ID-EEPROM SPI data out (connected to optional pin header)
39	TRXD1	Star (connected to optional pin header)
40	SCK	ID-EEPROM SPI clock (connected to optional pin header)

Table 4-4: FlexRay Physical Layer Modules

4.6 USER-LEDs and optional LC-Display (D1-D16, J6)

There are sixteen user LEDs on-board, D1-D8 connected to MCU port P25 and D9-D16 connected to MCU port P16. To disconnect the LEDs from the MCU, it is possible to remove RN3 (D1-D8 at port P25) and RN2 (D9-D16 at port P16).

It is also possible to connect a standard LCD module with backlight to connector J6. With the potentiometer RP1 the contrast of the LCD can be adjusted.

Pin	14	13	12	11	10	9	8	7	6	5	4	3	2	1	16	15
LCD	DB7	DB6	DB5	DB4	-	-	-	-	E	R/W	RS	VO	Vcc	GND	LED-	LED+
LED	D8	D7	D6	D5				D4	D3	D2	D1					
Port	P25_7	P25_6	P25_5	P25_4				P25_3	P25_2	P25_1	P25_0					
MCU	187	186	185	184				181	180	179	178					

Table 4-5: LED/LCD Signals

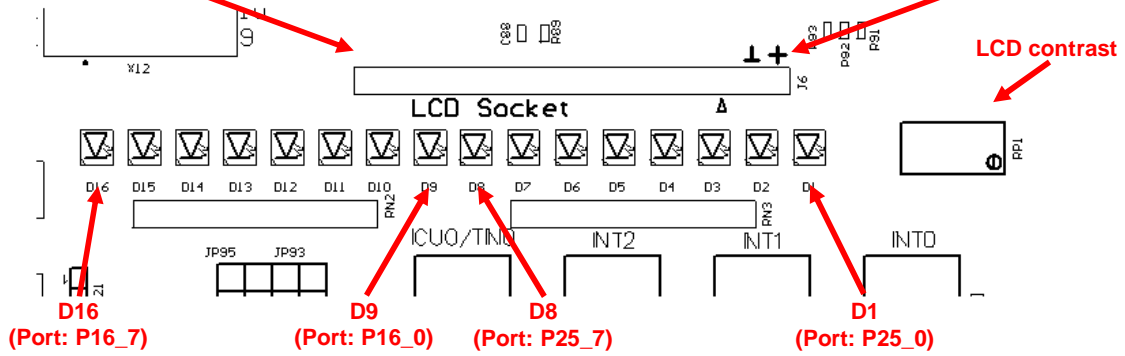

Figure 4-6: User LEDs / LCD

4.7 In-Circuit-Programming Connector (X12)

There is a Flash-programming socket on the starter kit which makes it possible to program the Flash MCU with a special programming adapter. Mode pins and reset signal is also available at this connector.

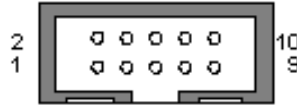

Figure 4-7: In Circuit Programming Connector

Pin Number	Pin Signal	Description
1	NC	Not used
2	NC	Not used
3	MD0	MCU mode-pin 0
4	MD2	MCU mode-pin 2
5	INITX	MCU reset signal
6	SIN4	UART4 receive data
7	SOT4	UART4 transmit data
8	SCK4	UART4 clock
9	VCC	Board supply voltage
10	GND	Ground

Table 4-6: In-Circuit Programming Connector

4.8 MCU Pin Connectors (J1-J4)

All MCU pins are directly connected to the four pin header around the MCU. The last two pins of the pin header J1, J2, J3 and J4 are unused (see PCB overprint).

Connector	MCU Pins
J1	1-52
J2	53-104
J3	105-156
J4	157-208

Table 4-7: MCU Pin Connectors

On the PCB, the corresponding pin numbers of the MCU are written next to the connector pins.

4.9 External Bus Connectors (X13, X14)

4.9.1 VG96ABC DIN 41612 (X13)

Pin	Name	MCU-P.	Pin	Name	MCU-P.	Pin	Name	MCU-P.
A1	2.5 V	-	B1	2.5 V	-	C1	2.5 V	-
A2	3.3V	-	B2	3.3V	-	C2	3.3V	-
A3	5.0 V	-	B3	5.0 V	-	C3	5.0 V	-
A4	GND	-	B4	GND	-	C4	GND	-
A5	D0	192	B5	D1	193	C5	D2	194
A6	D3	195	B6	D4	196	C6	D5	197
A7	D6	198	B7	D7	199	C7	D8	200
A8	D9	201	B8	D10	202	C8	D11	203
A9	D12	204	B9	D13	205	C9	D14	206
A10	D15	207	B10	D16	2	C10	D17	3
A11	D18	4	B11	D19	5	C11	D20	6
A12	D21	7	B12	D22	8	C12	D23	9
A13	D24	10	B13	D25	11	C13	D26	12
A14	D27	13	B14	D28	14	C14	D29	15
A15	D30	16	B15	D31	17	C15	GND	-
A16	GND	-	B16	GND	-	C16	GND	-
A17	A0	18	B17	A1	19	C17	A2	20
A18	A3	21	B18	A4	22	C18	A5	23
A19	A6	24	B19	A7	25	C19	A8	28
A20	A9	29	B20	A10	30	C20	A11	31
A21	A12	32	B21	A13	33	C21	A14	34
A22	A15	35	B22	A16	36	C22	A17	37
A23	A18	38	B23	A19	39	C23	A20	40
A24	A21	41	B24	A22	42	C24	A23	43
A25	A24	44	B25	A25	45	C25	NC	-
A26	NC	-	B26	NC	-	C26	NC	-
A27	NC	-	B27	NC	-	C27	GND	-
A28	P27_0	158	B28	P27_1	159	C28	P27_2	160
A29	P27_3	161	B29	P27_4	164	C29	P27_5	165
A30	P27_6	166	B30	P27_7	167	C30	GND	-
A31	2.5V	-	B31	2.5V	-	C31	NC	-
A32	GND	-	B32	GND	-	C32	GND	-

Table 4-8. VG96 (X13) Signals

Note:

The pin numbers of the VG connectors refer to the male connectors that plugs into the starter kit. Please see chapter 5 to find the right orientation.

4.9.2 VG48ABC DIN 41612 (X14)

Pin	Name	MCU-P.	Pin	Name	MCU-P.	Pin	Name	MCU-P.
A1	CSX0	56	B1	GND	-	C1	CSX1	57
A2	CSX2	58	B2	1.8V	-	C2	CSX3	59
A3	NC	-	B3	GND	-	C3	NC	-
A4	CSX6	60	B4	1.8V	-	C4	RDY	55
A5	BGRNTX	51	B5	GND	-	C5	BRQ	54
A6	RDX	50	B6	NC	-	C6	WRX0	46
A7	WRX1	47	B7	NC	-	C7	WRX2	48
A8	WRX3	49	B8	NC	-	C8	ASX	62
A9	NC	-	B9	NC	-	C9	MCLKO	65
A10	DREQ0	189	B10	NC	-	C10	DACKX0	190
A11	DEOP0	191	B11	NC	-	C11	NC	-
A12	INT12	97	B12	NC	-	C12	SDA0	99
A13	INT13	98	B13	NC	-	C13	SCL0	100
A14	SIN5	109	B14	Vin	-	C14	SOT5	110
A15	GND	-	B15	Vin	-	C15	SCK5	111
A16	INITX	73	B16	Vin	-	C16	GND	-

Table 4-9: VG48 (X14) Signals

Note:
The pin numbers of the VG connectors refer to the male connectors that plugs into the starter kit. Please see chapter 5 to find the right orientation.

4.9.3 Distance between VG-Connectors

To connect own applications to the starter-kit the following figure shows the distance between the VG DIN 41612 connectors.

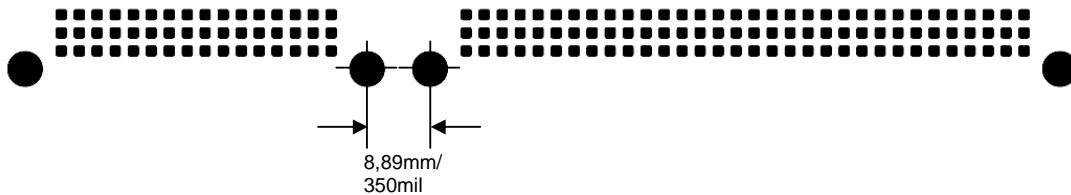

Figure 4-8: Layout of DIN VG Connectors

5 Connection between MB91F467DA and MB88121

The MB88121 series supports different host connectivity's.

The MB88121/A series support 16-bit none-multiplexed parallel Bus-interface.

To change to another connection some Jumpers settings needs to be changed.

The MB88121B series supports 16-bit none-multiplexed and 16-bit multiplexed parallel Bus-interface and SPI interface.

By default the 16-bit none-multiplexed parallel Bus interface is set at the board.

5.1 Settings for 16-bit none-multiplexed parallel bus interface

The 16-bit none-multiplexed parallel bus interface is supported by MB88121, MB88121A and MB88121B series.

Jumper	Setting	Description
JP1	1-2	Address line A10 MB88121 pin 35, MCU pin 30
JP2	1-2	Address line A9 MB88121 pin 36, MCU pin 29
JP3	1-2	Address line A5 MB88121 pin 40, MCU pin 23
JP4	1-2	Address line A4 MB88121 pin 41, MCU pin 22
JP5	1-2	Address line A3 MB88121 pin 42, MCU pin 21
JP7	closed	Address line A0 MB88121 pin 45, MCU pin 18
JP10	1-2	Data line D10 MB88121 pin 53, MCU pin 12
JP11	1-2	Data line D9 MB88121 pin 54, MCU pin 11
JP12	1-2	Data line D8 MB88121 pin 55, MCU pin 10
JP14	1-2	Data line D5 MB88121 pin 58, MCU pin 7
JP17	1-2	Data line D4 MB88121 pin 59, MCU pin 6
JP19	1-2	Chip Select MB88121 pin 19, MCU pin 59 (CS3)
JP20	1-2	Interrupt 2 pin MB88121 pin 22, MCU pin 89

Table 5-1: Jumper Settings for 16-bit none-multiplexed parallel bus interface

The DIP Switch settings are the default settings:

DIP Switch S1: all OFF (No function for this mode)

DIP Switch S2: S2/3 (MD2) and S2/6 (MDE2): OFF

All others ON.

See also chapter 3.2 and Chapter 3.3.

5.2 Settings for 16-bit multiplexed parallel bus interface

The 16-bit multiplexed parallel bus interface is supported by MB88121B series.

Jumper	Setting	Description
JP1	2-3	INT2 MB88121 pin 35, MCU pin 89
JP2	2-3	INT3 MB88121 pin 36, MCU pin 90
JP3	open	No function
JP4	open	No function
JP5	open	No function
JP7	open	No function
JP10	1-2	AD10 MB88121 pin 53, MCU pin 12
JP11	1-2	AD9 MB88121 pin 54, MCU pin 11
JP12	1-2	AD8 MB88121 pin 55, MCU pin 10
JP14	1-2	AD5 MB88121 pin 58, MCU pin 7
JP17	1-2	AD4 MB88121 pin 59, MCU pin 6
JP19	1-2	Chip Select MB88121 pin 19, MCU pin 59 (CS3)
JP20	2-3	ASX MB88121 pin 22, MCU pin 62

Table 5-2: Jumper Settings for 16-bit multiplexed parallel bus interface

The DIP Switch settings:

DIP Switch S1: all OFF (No function for this mode)

DIP Switch S2: S2/3 (MD2): OFF

All others ON.

See also chapter 3.2 and Chapter 3.3.

5.3 Settings for SPI interface

The SPI interface is supported by MB88121B series.

Jumper	Setting	Description
JP1	open	No function
JP2	open	No function
JP3	2-3	SCK MB88121 pin 40, MCU pin 114
JP4	2-3	SDI MB88121 pin 41, MCU pin 113
JP5	2-3	SDO MB88121 pin 42, MCU pin 112
JP7	open	No function
JP10	2-3	MDS2 MB88121 pin 53, DIP S1/3
JP11	2-3	MDS1 MB88121 pin 54, DIP S1/2
JP12	2-3	MDS0 MB88121 pin 55, DIP S1/1
JP14	2-3	INT2 MB88121 pin 58, MCU pin 89
JP17	2-3	INT3 MB88121 pin 59, MCU pin 90
JP19	1-2	Chip Select MB88121 pin 19, MCU pin 59 (CS3)
JP20	open	No function

Table 5-3: Jumper Settings for SPI mode

The DIP Switch settings:

DIP Switch S1: Selects the SPI mode.

DIP Switch S2:

Serial Mode selection:

S2/2 (MD1) and S2/3 (MD2): OFF

S2/1 (MD0): ON

MDE2,1 bit selects the external Frequency. The starter kit using 10 MHz crystal:

S2/5 (MDE1) and S2/6 (MDE2): OFF

S2/4 (MDE0): ON

See also chapter 3.2 and Chapter 3.3.

6 Getting Started

Make sure Softune Workbench for FR is installed on your PC and the “SK-91F467-FLEXRAY” or “SK-91F467D-208PFV” is ready to use (power-on (X5), serial connection (UART4) to COM port of the PC). Refer to Chapter 2 Installation for details on the hardware and software installation.

6.1 Introduction to Softune Workbench

Start Softune Workbench. Select <File> <Open Workspace> to load the first example “SK-91F467-FLEXRAY_test.wsp”. All examples can be found in the folder \software\examples on the starter kit CD-ROM. It is recommended to copy this folder to the local hard-drive. In the project tree on the left side, you can open the “source”-folder which contains the source-files registered to this project. A double-click on one of the files will invoke the built-in editor, which supports syntax-highlighting, tags and various other functions.

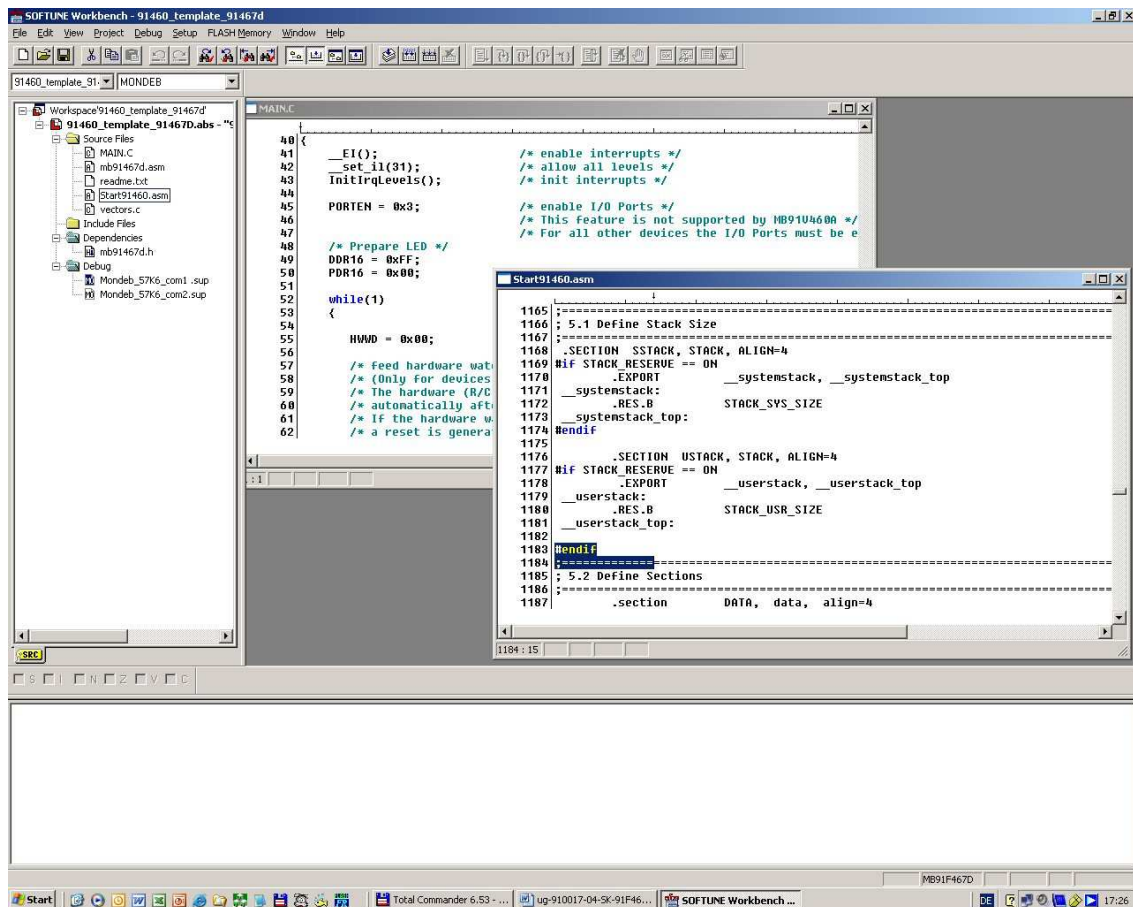

Figure 6-1: Softune Workbench main window

Note:

You may customize the editor by a right-click on the editor window.

Whenever you modify the source-files, you have to re-compile and link the related files to produce a valid load module (ABS-file). This is done using the MAKE-function. MAKE invokes the assembler, C-compiler and linker for FR whenever necessary (only modified files will be re-compiled).

If you wish to re-compile the entire project regardless of any changes, you can use the BUILD-function. To check for syntax-errors on a specific source-file, use the COMPILE/ASSEMBLE function.

These three functions are available on the button-bar or from the main menu (Project – Compile / Make / Build / Abort).



Click on MAKE or BUILD. Messages from the individual language tools will be fed into the output window at the bottom of the main screen. If the tool chain (C-compiler → Assembler → Linker) was completed successfully, the message “No Error” will appear.

If you get any errors during compilation, an appropriate message will be generated. Try this with a simple syntax-error (e.g. delete a semicolon “;” from the end of a C-line) and click on MAKE again. You will now see a message like this:

```

Now Making...
-----Configuration: Starterkit91302_Test.prj - Debug-----
main.c
*** C:\SK-91F467-FLEXRAY\SK-91F467-FLEXRAY_Test\Src\main.c(81) E4065B: expected a ";"
*** C:\SK-91F467-FLEXRAY\SK-91F467-FLEXRAY_Test\Src\main.c(104) W1012B: warning: parsing
restarts here after previous syntax error
1 error detected in the compilation of
"C:\SK-91F467-FLEXRAY\SK-91F467-FLEXRAY_Test\Src\main.c".
-----
Error detected.
-----
    
```

To locate the position in the source-file, where the error has occurred, double-click on the message. The editor will open the appropriate source-file, indicating the error highlighted in red, depending on the customise settings of the editor. Correct the error and re-compile the project as explained above.

If more errors occurred, you can go through the error list step by step using the menu “Edit – Top/Previous/Next/Bottom Error” or using the appropriate buttons which have the same functions:



Note:
To get on-line help about a specific error, select the error message and press F1. In many cases, you can get some useful hints how to solve the problem. Of course, you can also use the HELP-menu anytime during development or debugging.

6.2 Project Start-up

In order to allow a quick and smooth project start-up Fujitsu Microelectronics Europe supplies a template project as a reference. The easiest way to start a new project is to make a copy of the template project and use this copy as a start-up. The template includes the latest start91460.asm file, MCU header file, IRQ table, basic linker and C-Compiler settings.

Note:

In any case the settings done in the template must be checked and have to be adjusted to the specific needs and settings of the final application. The template is providing an example for building up a new project.

THIS SAMPLE CODE IS PROVIDED AS IS AND IS SUBJECT TO ALTERATIONS. FUJITSU MICROELECTRONICS ACCEPTS NO RESPONSIBILITY OR LIABILITY FOR ANY ERRORS OR/ELIGIBILITY FOR ANY PURPOSES. (C) Fujitsu Microelectronics Europe GmbH

6.2.1 Create a New Project:

1. In order to start a new user-project use the “**91460_template_91467d**” project
2. **Copy** the folder **91460_template_91467d** and **rename** the folder to e.g. **my_application**

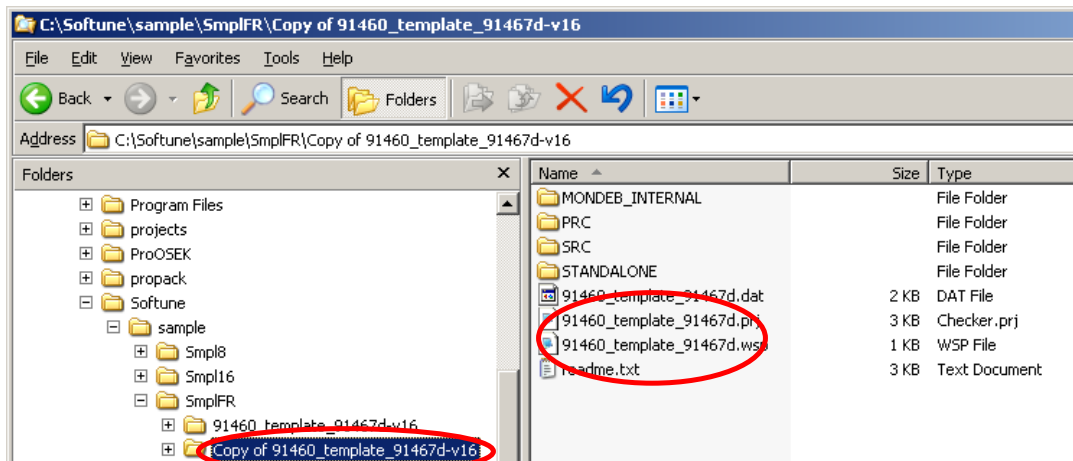

3. **Enter the folder “my_application”**
 Rename “91460_template_91467d.prj” into “my_application.prj”
 Rename “91460_template_91467d” into “my_application.wsp”
4. **Edit “my_application.prj”**
 Rename “91460_template_91467d” -> “my_application”
5. **Edit “my_application.wsp”**
 Rename “91460_template_91467d” -> “my_application”

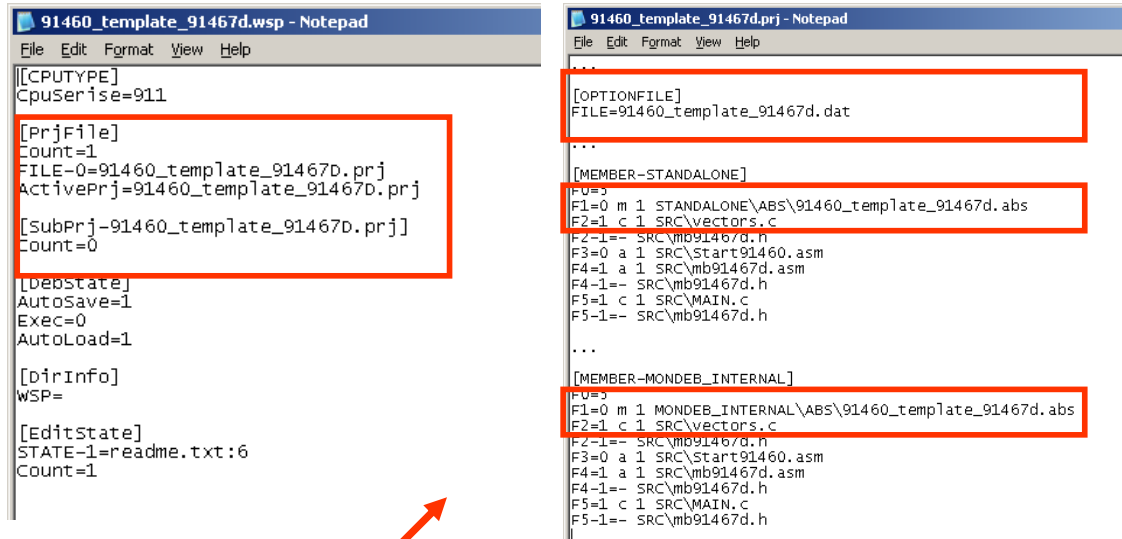

Rename “91460_template_91467d”
into “my_application”

6. Start Softune Workbench and open your project

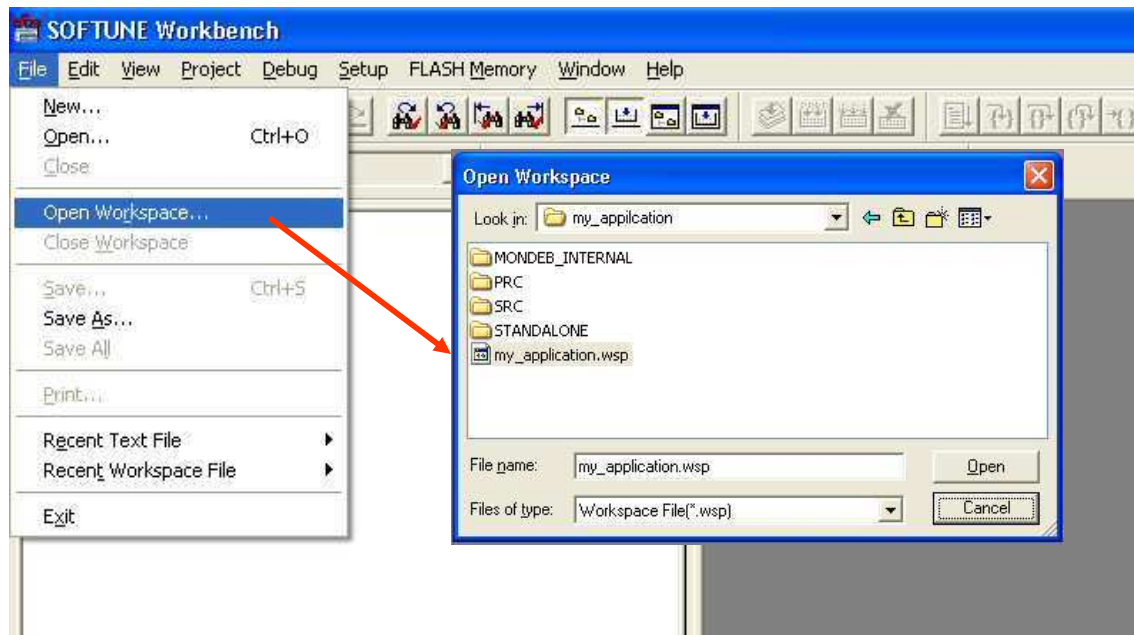

Figure 6-2: Open Softune Workbench workspace (*.wsp)

7) Select Active Configuration “MONDEBUG”

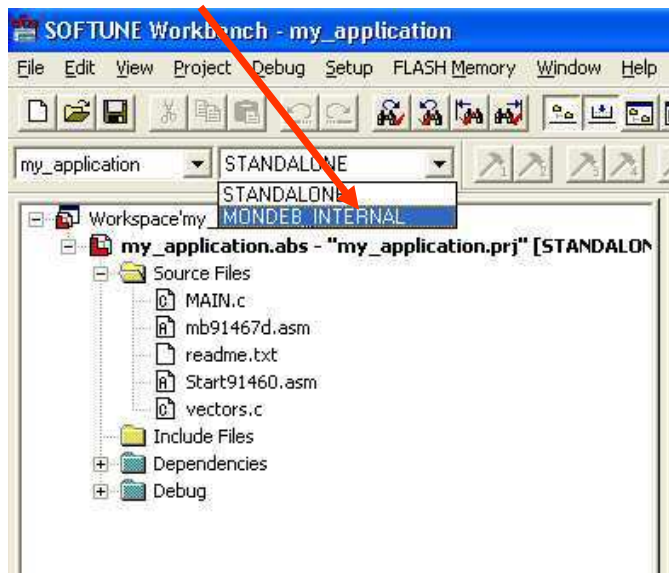

Figure 6-3: Project configuration selection

6.2.2 Use Active Configuration MONDEBUG_INTERNAL

With this selection the project is linked to be used with the Softune Workbench monitor debugger. Corresponding linker settings are done for the memory map in order to avoid overwriting of the sections which are used by the monitor debugger. The code is linked in this configuration for external SRAM, otherwise it is not possible to debug code with the Softune Workbench monitor debugger. The monitor

Note:

Always check the memory map of the linker settings and ensure that this memory map is suitable for the application and target system in use. Additionally the .mp1 file should be checked to ensure correct settings.

7. Check MCU settings in the module **start91460.asm**. Be careful regarding any modifications. If the peripheral clock speed is modified it can happen that the communication between Softune Workbench and monitor debugger is lost. In the module **start91460.asm** some basic MCU settings are done and some initial data copy transfers are performed for specific data sections e.g. INIT. Check module **vectors.c** if any interrupts are used for proper vector table set-up.
8. Write application code in the module **main.c** or add any other module to the project.
9. Write and modify source code and settings corresponding to the needs of the application. Finally use “**Make**”, or “**Build**” to compile and link the project. The generated output files can be found in the sub-folder **MONDEB_INTERNAL** of the project folder. The *.mhx file (Motorola S-Record) is located in the ABS sub-folder.

Note:

Always check the memory map of the linker settings and ensure that this memory map is suitable for the application and target system in use. Additionally the *.mp1 file should be checked to ensure correct settings..

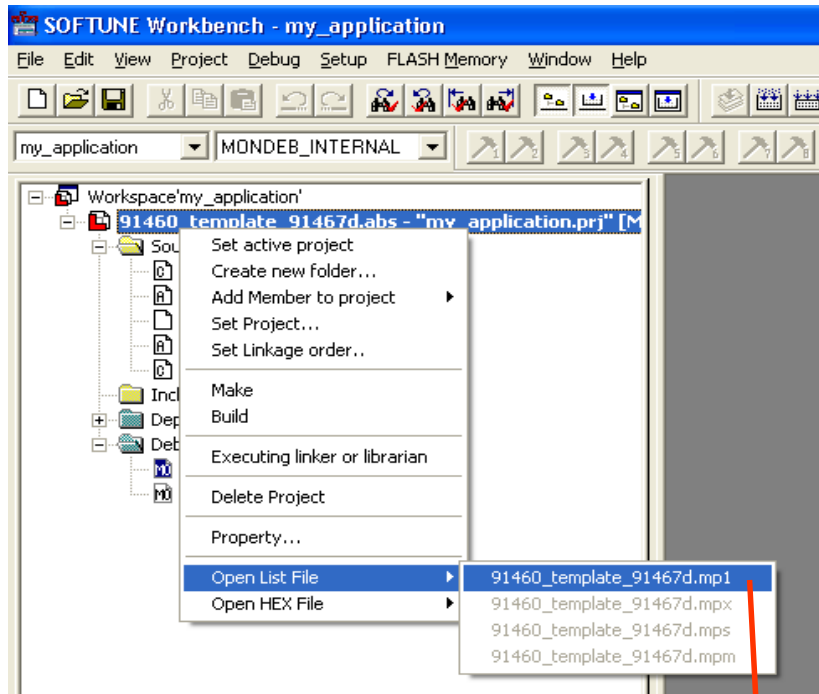

Figure 6-4: Open Softune Workbench Linker mapping file

Check linker mapping list in the*.mp1 file by right-click on “my_application.abs”, Open List File, *.mp1.

```

45 ■FR/FR80 Family SOFTUNE Linker Mapping List
46
47 S_Addr. -E_Addr.   Size      Section Type A1      Sec.(Top 81)
48 00029000-00029003 00000004  DATA  P RW-- 04 REL  DATA
49 00029004-000293FF 000003FC  STACK  P RW-- 04 REL  SSTACK
50 00029004-.....    00000000  DATA  P RW-- 04 REL  INIT
51 00029400-00029401 00000002  STACK  P RW-- 04 REL  USTACK
52 00840000-00840307 00000308  CODE   P R-XI 02 REL  CODE
53 00840308-00840707 00000400  CONST  P R--I 04 REL  INTVECT
54 00840308-.....    00000000  CONST  P R--I 04 REL  CONST
55 00840308-.....    00000000  DATA  P R--  04 REL  #INIT
56 008F4000-008F4223 00000224  CODE   P R-XI 04 REL  CODE_START
    
```

Figure 6-5: Softune Workbench Linker Mapping

Start Softune Monitor Debugger via the “Debug” Command

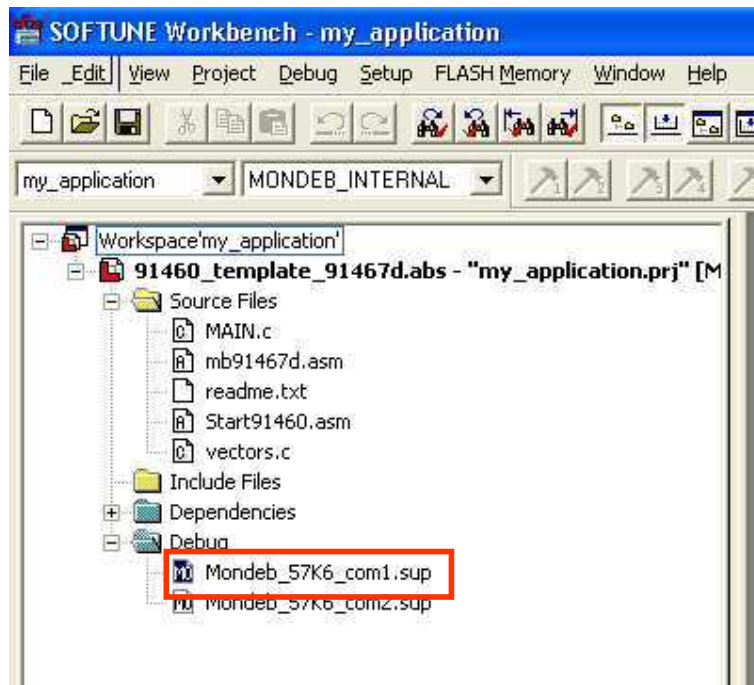

Figure 6-6: Start Softune Workbench Monitor Debugger

10. After the project is built and debugged successfully switch to the active configuration **STANDALONE**

6.2.3 Use Active configuration STANDALONE

11. With this selection the project is linked to work in internal flash memory. This configuration will not work with the Softune Workbench monitor debugger. In this configuration the code is linked to work in internal Flash memory, only.
12. Use “**Make**”, or “**Build**” to compile and link the project for internal Flash memory. The generated output files can be found in the sub-folder STANDALONE of the project folder. The *.mhx file (Motorola S-Record) is located in the ABS sub-folder.

Note:

Always check the memory map of the linker settings and ensure that this memory map is suitable for the application and target system in use. Additionally the *.mp1 file should be checked to ensure correct settings.

13. Program the generated *.mhx file (Motorola S-Record) with the Flash programming utility into the internal Flash. See Chapter 7.1 “Programming the internal Flash Memory” for more details.

Note:

It is not possible to use the Softune Workbench monitor debugger with this configuration because no code can be debugged which is located in internal Flash. Also this configuration does not support special debugger settings, which are disabled for this configuration.

6.3 Softune Workbench Monitor Debugger

6.3.1 General Description

Whenever you have created a valid load module successfully, you can switch from the development mode to the debugging mode of Softune Workbench.

Basically, there are 3 types of debugging systems supported :

1. The software simulator: This type of debugger is always present and does not require any special hardware extensions. The simulator will cover the FR-core features, but no peripheral functions. Therefore, you can use the simulator to verify program flow, check for dynamic errors, look at the generated assembler code , etc. .
2. The monitor debugger: This debugger type requires an evaluation board like the “SK-91F467-FLEXRAY” connected to one of the COM-ports of your PC. Therefore, make sure the evaluation board connected and powered-up as described before. Explanations in this manual refer to the monitor debugger only.
3. The emulator debugger: The in-circuit-emulator (ICE) is a system, which allows a connection to any target system using a probe-cable. The appropriate system for the MB91F467DA series is the MB2198-01 system. More information about this system can be found on Fujitsu's website.

Which debugger is used for the actual project can be configured in the project tree as shown below or in the “Project – Setup Project – Debug” menu. The current selection is blue marked (icon):

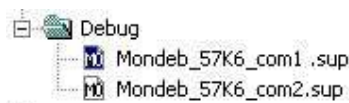

The default settings for the monitor debugger are: **COM-Port 1, 57K6 baud, 8N1**. If you wish to change the COM-port, please right-click on the “Mondeb_57K6_com1.sup” entry and select change.

Note:

If you change the baud rate or use a different crystal frequency, you have to change the UART-settings in the debugging kernel source project, re-compile and flash the new kernel to your “SK-91F467-xxx” board first. The project can be found in Software\SWBMonitorDebugger. All settings are done in the module u_io.asm.

If these settings are correct, start your debugging session:

Make sure you have connected the “SK-91F467-xxx” starter kit and your monitor-kernel is stored in the internal flash memory of the MB91F467DA series at the starter kit. Then power up and reset the starter kit. Check the following configurations:

1) Correct CPU Mode selection (DIP-Switch S5)

After Power on the Monitor debugger indicates via the 8 user-LEDs the current status. The following status indications exist. Ensure that the CPU is working in normal RUN Mode (DIP-Switch S5 **position all OFF**)

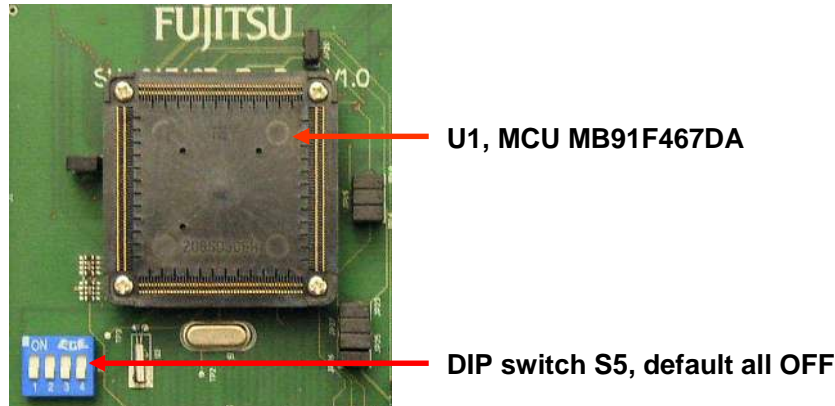

Figure 6-7: MB91F467D and mode pin DIP switch

2) Correct start-up of the monitor debugger

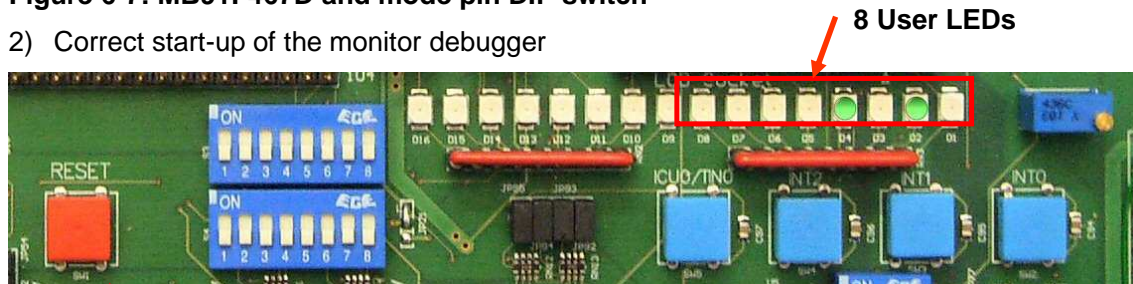

Figure 6-8: Reset button and user LED

Reset

In case of any other status indication push the reset button or check chapter 6.6.1 for detailed information.

Start the debugger by double clicking the “Mondeb_57K6_com1.sup” entry in the project/debug tree - or by using “Debug – Start Debug” from the menu. You should see a progress bar indicating the download process.

If no process is indicated an error message will occur (“e.g. Invalid communication status”). Double-check the settings again as explained above. Also make sure the evaluation-board is powered on, ready to use and the RS232-cable is connected properly. Also see the troubleshooting section in the appendix.

After starting the debugger, the source window will be opened which contains locate-arrows for each (possible) source-line, the original source-code,

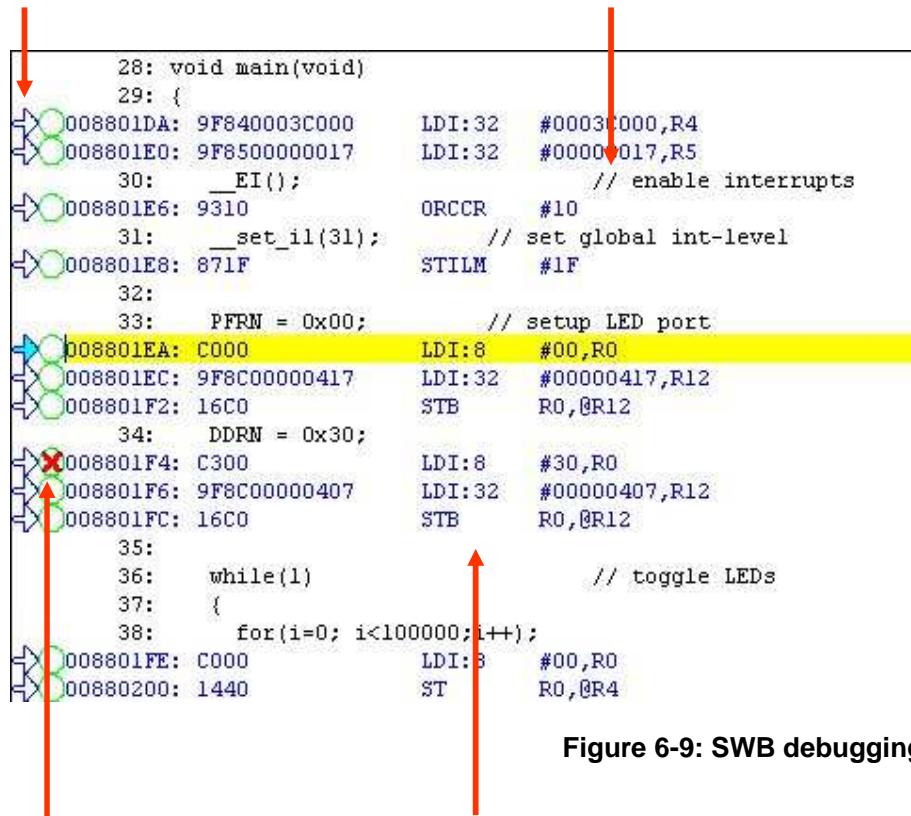

Figure 6-9: SWB debugging window

Breakpoint-indicators and the assembler code (in “mixed view”). The current program position will be indicated by a yellow line. Use right-click in the source window to configure the view (add/remove control characters, View Mixed source code, Breakpoint ...)

Note:

You can choose “mixed view” from the context menu (right-click) to display source and assembly code at the same time. The command “go to current” will take you to the active code line!

6.3.2 Basic Debugger Features



GO: Executes the program continuously from the memory location pointed to by the current program counter (PC) until a termination factor occurs.



STEP IN: Executes the program stepwise according to the listing in the source window (steps in C- or ASM). Note that interrupts are disabled during step execution !



STEP OVER: Executes the program stepwise except call-instructions (which will be executed until return). Interrupts are not disabled during a continuous CALL...RETURN execution.



STEP OUT: Executes the program continuously to the parent function (until RETURN). Interrupts are enabled. Note, that debug information is required for this function.



EXECUTE UNTIL CURSOR: Automatically sets a breakpoint at the actual cursor position and executes continuously until this breakpoint, which will be deleted afterwards.

Each valid code line in a debugger window automatically has a locator (blue arrow) and a breakpoint-option (circle). Note that some C-lines may not be displayed with locators and breakpoints, because the compiler has created “optimized” assembler-code. Select “mixed view” in order to check the compiler output.

Instead of single-steps, you may also use the arrows to directly execute your program until a certain line of your source-code :

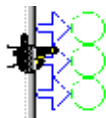



ABORT: Forcibly terminates execution. This button is not fully supported by the monitor debugger and may cause malfunction if used to abort “continuous operation” of the MCU.

This command button can only be used to abort single code line operations

Example: `for(k=DELAY_CONSTANT; k>0; k--);`

Use the **button INT0** on the “SK-91F467-xxx” for **ABORT** function.





To **ABORT** continuous execution on the “SK-91F467-xxx” starter kit, you have to use the **INT0 button** on the “SK-91F467-xxx” starter kit.

6.4 Advanced Monitor Debugger Features



TOGGLE BREAKPOINT: Sets or deletes breakpoint at the current source line:

To set or delete a breakpoint, click the circles at the beginning of a source-line.

A  indicates an active breakpoint. Hit “Run continuously”  to execute code until reaching this line. A list of all breakpoints can be found under the “Debug – Breakpoint” menu. 255 Software-Breakpoints (using TRAP replacement) are possible.

Note:

To set breakpoints at positions which are currently not visible (e.g. because the source window of that module is not open), you can also enter a symbolic label directly in the “Breakpoint” menu. Example: Enter “main” in the address-field and confirm. The new breakpoint will automatically be assigned to the address of the “main()”-function.



REGISTER WINDOW: Displays the CPU-register window. Updated registers appear in red. *Setup* in context menu defines which Registers should be displayed.



WATCH WINDOW: Displays the current variables to „watch“. Double-click on any variable in your code then specify *watch* in context menu to add to watch window. All listed variables in a watch window can be displayed in any number format. Use *Edit* to directly change the contents.



MEMORY WINDOW: Displays memory areas in various formats defined by *Setup* (context menu). Changing of address/data is possible when debugger is not executing.

The memory window can be very helpful to check the registers or the frame memory of the connected graphic controller !



DISASSEMBLER: Disassembles the content of the code memory beginning from actual PC position and displays the result in a separate window. Individual assembler-lines can be changed using the „inline assemble“-function.

DEBUG - STACK: Displays the current stack contents in terms of function calls. Parameters, if any, are displayed in brackets.

DEBUG - VECTOR: Reads out and displays the actual interrupt-vector table. Use the „jump“ function to display any code areas pointed to by an interrupt vector (e.g. interrupt service routines used in your program).

DEBUG - CALL: This function can be used to „call“ any routine defined in your code when the debugger is on hold.

DEBUG – LOAD TARGET FILE: Starts a new download of the current load module (ABS file). Usually this function will be executed automatically after starting the debugger (defined in debug settings ; see „Project-Setup-Debug“). However, this function can be useful to re-initialize the debugger for the current debug session.

VIEW - SYMBOL: This function displays all (global) symbols of the current project. Information about the type (char, integer etc.) and the location (address in RAM or register) can be shown using „detail“.

VIEW - LOCAL: Similar to View-Symbol, but only local variables of the current function are shown.

VIEW - COMMAND: From this window, the debugger can be controlled using a command line input. All GUI functions are available as individual commands.

Example:

Run continuously

Step

Examine PDRG

Set break main

Dump/Halfword 0x2000000..0x20000FF

Shortcuts to complex commands can be defined (“alias”) and parameter strings can be substituted by variables.

Example: mydump = Dump/Halfword 2000000..20000ff

A set of commands can be combined to a “macro”. Aliases and macros can be defined using the command window context menu.

Example: restart: set register PC=2000000
 set break main
 Run continuously

In order to document or save debugging details such as memory contents, all outputs fed to the command console can be written to a file (“logging”).

A whole “program” of commands (incl. flow control) can be written to a PRC-file and executed. Procedure-files are simple text-files with the extension “.PRC” and can be created by the Softune Workbench editor or any other text editor. To execute a procedure-file, use the command window menu or the “file-open” menu during debugging.

Note:

Procedure-files can be very helpful to configure the debug-environment automatically, perform automated tests (e.g. when a new C-module has to be tested) or to enhance basic emulator functions such as breakpoints. Using a procedure file, breakpoints can be defined dynamically depending on program conditions. See the “Command Reference Manual” (on-line help) for detailed information about the available command and parameter syntax. Some procedure files exist already included in the example project directory.

6.5 Memory Configuration for User Applications

Valid load module files can only be achieved if the language tool configuration is appropriate. The most convenient way to create owns a project is to copy the provided Template-Projects from the example-directory and use it as “blank sheet”.

If the Softune Monitor debugger is being used the following memory areas are reserved by the monitor debugger and must not be used by the application.

Memory Map of Softune Workbench Monitor debugger			
91460_mondeb_uart4-v11			
Memory Type	Used for	Area(s)	Sections
Internal CPU Data RAM	Stack, Data	0x28000 - 0x28FFF	STACK, DATA
Internal Flash Memory of MB91F467DA series	Debug Kernel	0x000F:0000-0x000F:FFFF	CODE, CONST
	Vector Table	0x0F:FC00-0x0F:FFFF	INTVECT
<p>Note: Be aware that the memory map may depend on the debugger version and any modifications of the debugger made by the user.</p>			

Table 6-1: Memory map of Monitor debugger 91460_mondeb_uart4-v11

Note:

The following chip select areas are used by the Softune monitor debugger and must not be used or overlap with other chip select areas:

CS1 – SRAM

0x0080.0000 - 0x009F.FFFF

Always check the Linker Settings (“Project – Setup Project – Linker – Disposition”) to make sure the following memory map is applied according to the project configuration:

Recommended linker settings for “SK-91F467-xxx” starter kits for debugging			
Memory Type	Used for	Area(s)	Sections
Data RAM,	Variables, Stack	0x029000 - 0x02FFFF	DATA, INIT, STACK
External SRAM 1MB	Code, Const, IRQ Vector Table	0x00840000 - 0x0094FFFF	CODE, CONST

Table 6-2: Linker Settings for MB91F467DA Monitor Debugger configuration

Note:
In any case all settings must be checked and corrected corresponding to specific application requirements. Also check settings in the start91467.asm initialisation file! Use the linker mapping list (e.g. *.mp1 file) to check the final memory allocation.

The following chip select areas are used by the Softune monitor debugger and must not be used or overlap with other chip select areas:

CS1 – SRAM 0x0080.0000 - 0x009F.FFFF

Checklist for project configuration:

- **Make sure, the correct Target MCU (“Project – Setup Project - MCU” menu) MB91F467D is selected.**
- **Use the correct linker settings as outlined above depending on your target MCU and the target area (embedded flash or external RAM).**
- **Use the provided templates to make sure the sections are located correctly.**
- **Always check the *.mp1 file (use right mouse click on top *.abs file in the project window of Softune Workbench and select “open list file”) to see the used sections and address areas!**
- **The following Chip select areas are used by the Softune monitor debugger and must not be used or overlap with other chip select areas:**

CS1 – SRAM 0x0080.0000 - 0x009F.FFFF

Note:
Be aware that the Softune Workbench monitor debugger is only able to debug code which is located in RAM! It is not possible to debug code located in Flash memory!

7 Flash Programming

7.1 Programming internal Flash of MB91F467DA series

To program the Monitor debugger or any other Application into the internal Flash memory of MB91F467DA series following steps must be taken.

- 1) To install the Flash Programming utility on the PC the following steps must be taken
 - a. Browse to the folder “Software\FlashProgramming” of the starter kit CD-ROM and execute the FME_FR_Flashprogrammer_v3_7.exe file. The default installation folder is: C:\Softune6\Utility\
 - b. Start Flash Programming tool by double click flash.exe within the installed folder: C:\Softune6\Utility\FME_FlashProgrammer_v3_7\flashprg.exe
- 2) Open the Flash programming Utility by double click the flashprg.exe file
- 3) Select CPU type, COM Port, baud rate, Hex File as shown in the following figure
 - a. Device Type: MB91F467D
 - b. Com port: 1
 - c. Baudrate: 38400
 - d. Hex File: MonDeb91467D.mhx

Use button “Browse” and browse to
c:\.\Software\MonitorDebugger\ MonDeb91467D.mhx

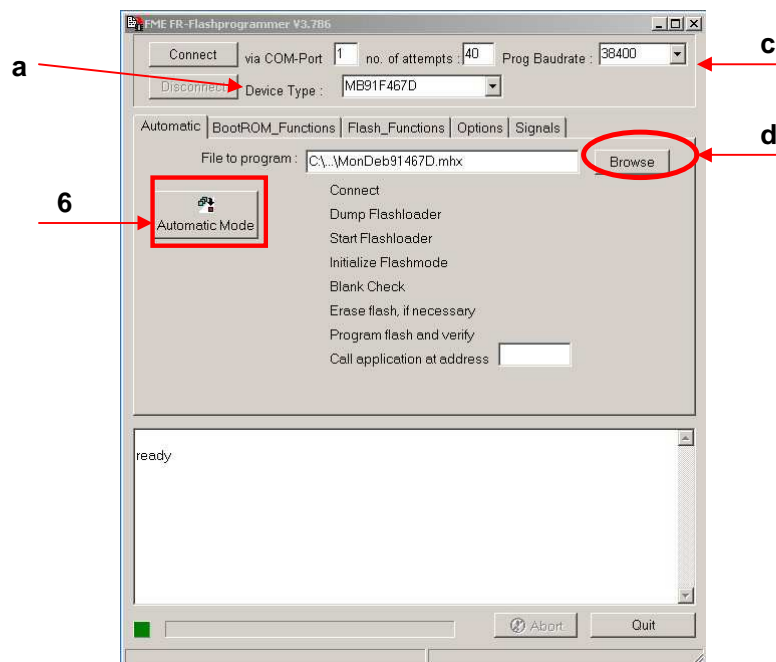

Figure 7-1: FME FR-Flash Programmer for MB91F467D series

- 4) Connect starter kit and PC with a RS232 cable. MB91F467 is using UART4 interface for serial Flash Programming.
- 5) Power-off the board or assert and hold RESET
- 6) Press "Automatic" button to start automatic Flash Programming
Using the "Automatic" button the Programming steps are automatically proceed by the Flash Programmer Utility.
- 7) Power-on the board or release RESET to start Flash Programming
After pressing the "Automatic" button release the RESET button or power on the starter kit in order to start boot Rom execution of MB91F467DA series.
All steps are proceed automatically, download the Flash Programming routine, 'blank check', Flash erase if necessary and Programming the Application.

Following is displayed in the message window in case of successful programming:

```
Sending start characters...
Connection OK.
Filesize=8192 (0x2000)
bincommand:
write
writing 8192 bytes...
  received checksum = 4426 (0x114A)
  calculated checksum = 4426 (0x114A)
OK - checksums match
write finished.
Sending Baudrate Information:
  received checksum = 114 (0x0072)
  calculated checksum = 114 (0x0072)
OK - checksums match
write byte finished.
Baudrate set (write byte) finished.
calling address 0x030000
bincommand:
"call"
call initiated - waiting for returnvalue...
returnvalue = 254
searching for flash-loader...
Flash mode activated (">" received)
Checking...
Blank Check finished
Chip erase in process...
```

```
CAUTION : DO NOT INTERRUPT OR CUT OFF POWER DURING ERASE !!!  
Chip-erase successful  
Sending download command  
loading and programming...  
00148000: Security Address not programmed, use Prog Word!  
00148004: Security Address not programmed, use Prog Word!  
00148006: Security Address not programmed, use Prog Word!  
001448008: Security Address not programmed, use Prog Word!  
0014800C: Security Address not programmed, use Prog Word!  
0014800E: Security Address not programmed, use Prog Word!  
Download and programming completed  
Automode finished.  
COM port closed  
automatically disconnect
```

Figure 7-2: FME Flash Programmer output message window

As shown in the message window the Security address is not programmed in Automatic programming process. This is done for security reason to avoid the activation of the Security function by accident.

- 8) After successful programming assert Reset or Power-off / On the board in order to start the programmed application.

Note 1:

The MB91F467DA series is checking the serial UART4 interface for valid string to enter Flash programming mode. For details about boot sequence refer to Hardware Manual of MB91460 series.

Note 2:

Be aware of Security Features of MB91F467DA series. Check Documentation of MB91460 series for detailed information!

8 Trouble shooting

Problem	Solution
<p>Starter kit does not power-on correctly. Some or all of the power LEDs (D24, D30, D34, and D40) do not lit up.</p>	<p>Check voltage supply and jumpers :</p> <ul style="list-style-type: none"> ☛ The voltage on DC-Power plug should be in the range of 9-12V. The plug should have + on shield and – on the centre. The power supply should be able to supply at least 500mA. To support both, the “SK-91F467D-208PFV” and a graphic sub-board the supply should be able to supply 1500mA. * The LEDs should light up after switching on the board. Use a multimeter to see whether 5V,3.3V, 2.5V and 1.8V are present on the Vcc/GND test measurement points J21, J22, J23 and J24. ☛ Check jumper positions according to chapter 2.1 ☛ Remove all user extensions of the starter kit
<p>Starter kit stays in reset. LED D18 (Reset indicator) lights up permanently.</p>	<ul style="list-style-type: none"> ☛ LED D18 (Reset) should flash. If D18 lights up permanently, the voltage is too low - Increase the voltage supply and check available supply current to solve the problem. ☛ Remove all user extensions on the board to avoid any shortcuts or leakage current!
<p>The communication from Softune Workbench to the evaluation board fails (Communication errors)</p>	<ul style="list-style-type: none"> ☛ Make sure your COM-port number and the baud rate settings are correct (see debugger introduction). The default COM-port is 1 and the default baud rate is 57K6Baud. ☛ Make sure no other programs are using the same COM-port on your PC. Close all other applications (e.g. Flash programmer utilities, terminals etc.) * Check if RTS/CTS is closed on the CPU module (check jumper JP58, 60, 65 are closed). * Use only a RS232 extension 1:1 cable
<p>The windows of the debugger are empty.</p>	<ul style="list-style-type: none"> * This is due to wrong (maybe old) file path information. Closing all windows in the debugger and re-open should fix the problem.
<p>When trying to program the application to the embedded flash, the programmer stops at first address with “loading error” !</p>	<ul style="list-style-type: none"> * You are probably trying to program a program to the flash which is linked for the external RAM area. Check for details the linker memory map and the linker output mapping file *.mp1 file.
<p>Hardware units such as LEDs, user buttons, UART are not working.</p>	<ul style="list-style-type: none"> ☛ Make sure you have enabled these units on the evaluation board using the appropriate jumpers. See the provided examples and the hardware manual for information on how to control the peripherals.
<p>LCD at parallel LCD port does not work</p>	<ul style="list-style-type: none"> ☛ Adjust the potentiometer RP1 to adjust contrast of LCD. Remove resistor network RN3
<p>Graphic sub-board does not work</p>	<p>Check power supply 9-12V/1500mA. Reduce external bus clock frequency</p>

Table 8-1: Trouble shooting

9 Silk-Plot of the Board

9.1 Top Side

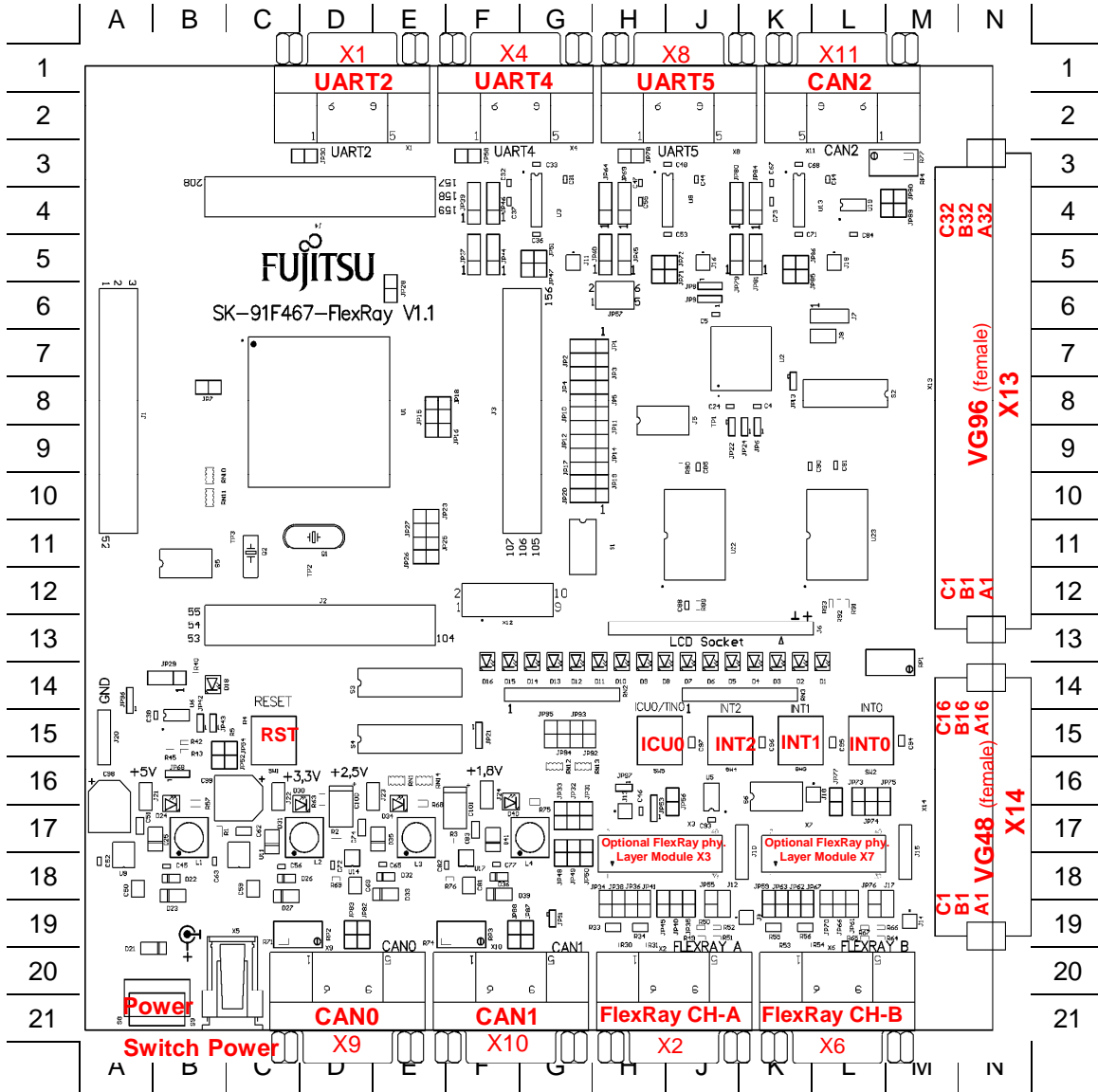

Figure 9-1: Board Layout (Top Side)

9.2 Bottom Side

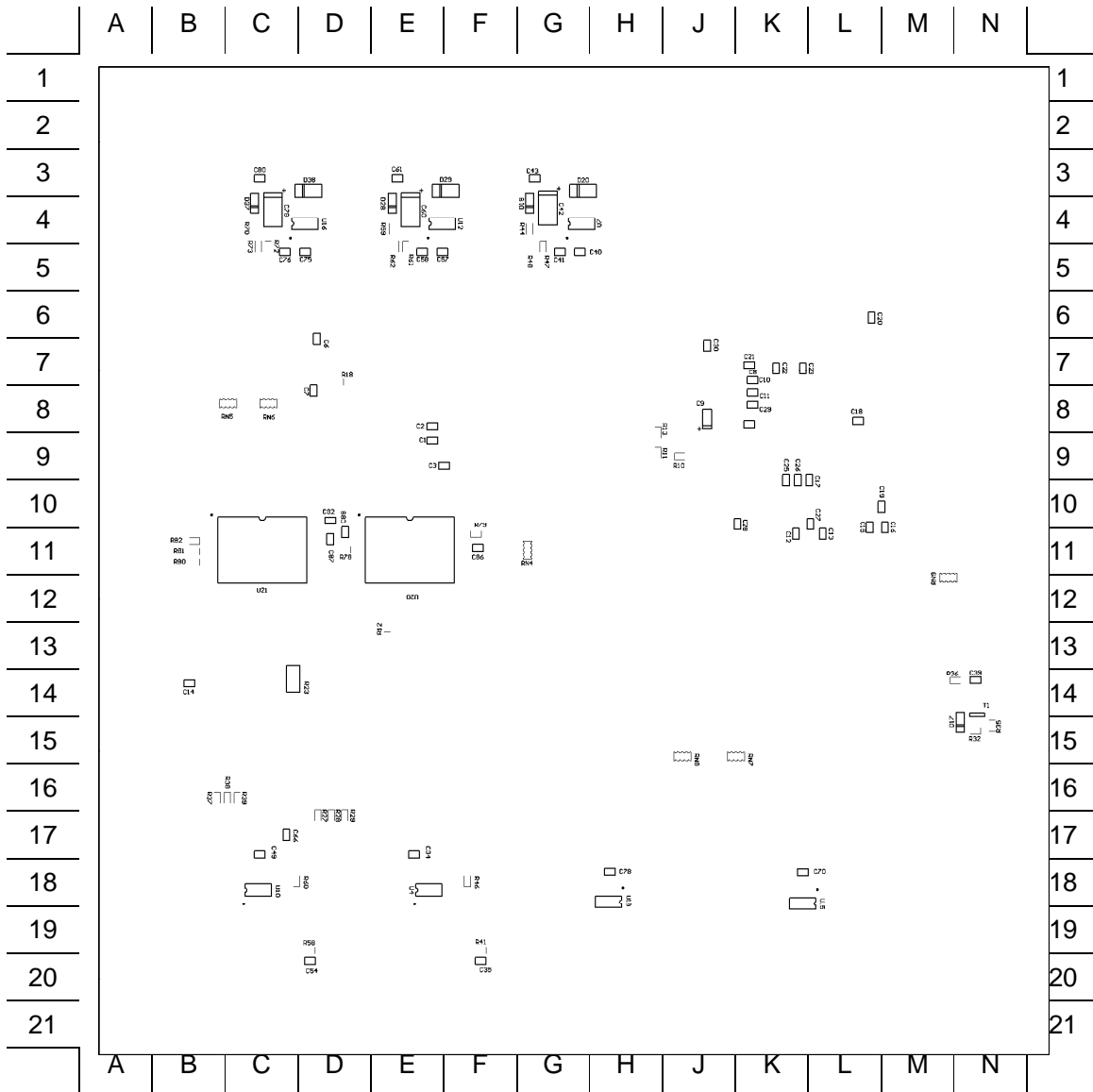

Figure 9-2: Board Layout (Bottom Side)

10 PCB History

10.1 SK-91F467-FLEXRAY V1.0

Part	Problem	Fixed
U20	Wrong UB/LB connection (WRX2 and WRX3 has to be connected)	V1.1
X14	Connect 1.8V supply not directly to X14 (add jumper)	V1.1
U6	Additionally pull-up resistors for MCU and ASSP reset line	V1.1
U6	Reset button connection (SW1), add further option to activate reset directly when pressing SW1. Actually, SW1 must be pressed 2s to activate reset. (add solder jumper to select one option)	V1.1
U9	Add C=220uF/16F between Vcc5V and GND	V1.1
U11	Add C=220uF/16F between Vcc3V3 and GND	V1.1
U14	Add C=100uF/16F between Vcc2V5 and GND	V1.1
U17	Add C=100uF/16F between Vcc1V8 and GND	V1.1

Table 10-1: History PCB V1.0

10.2 SK-91F467-FLEXRAY V1.1

Part	Problem	Fixed
R45	Reset circuit: Low voltage detection of 1.8V or 2.5V. The used value of R45 (20K Ohm) defines the voltage level to close to the low voltage detection of the Reset-chip. Using a 30K Ohm resistor defines an higher voltage. The Resistor R45 is changed to 30K Ohm since production date: 23-32/06 (see label at bottom side of PCB)	Since production date: 23-32/06
U2 / MB88121	Since PCB production code 18-47/06 the MB88121B version is used instead of MB88121A. The jumper settings for MB88121 power supply are set accordingly. (See chapter 3.4.4)	Since production date: 18-47/06
U2 / MB88121	Since PCB production code 18-17/07 the MB88121B is directly soldered, no socket is used.	Since production date: 18-17/07

Table 10-2: History PCB V1.1

11 Appendix

11.1 Related Products

- SK-91460-MAIN Evaluation main board for MB91460 Series
- SK-91460-91F467D-208PFV MCU-board incl. MB91F467DA for SK-91460-MAIN
- SK-91F467D-208PFV Evaluation board with MB91F467DA
- SK-91F467-FLEXRAY Evaluation board with MB91F467DA and MB88121A
- ADA-91V460-91F467D Conversion adapter MB91V460 to MB91F467D

- MB2198-01 Emulator debugger main unit
- MB2198-10 DSU cable
- MB2198-300 Adapter board for MB91V460 emulation chip (BGA-660P)
- MB91V460 Emulation chip of MB91460 Series
- PB-91467D-208PFV Probe cable for MB91F467DA target system
(Recommended for SK-91F467D-208PFV)
- PB-91467D-NLS-208PFV Probe cable for MB91F467DA target system
(Recommended for SK-91F467-FLEXRAY)
- NQPACK208SD Socket for package FPT-208P-M01 and FPT-208P-M04
Tokyo Eletech Corp. www.tetc.co.jp/e_tet.htm
- HQPACK208SD306H Header for FPT-208P-M01 e.g.: MB91F467D
- YQPACK208SD Joint connector extension for NQPACK208SD
- YQSOCKET208SDN Joint connector socket for NQPACK208SD

- MB91F467DA Flash chip of MB91460 Series
- MB88121A FlexRay Communication Controller

11.2 Information on the WWW

Information about FUJITSU MICROELECTRONICS Products can be found on the following Internet pages:

Microcontrollers (8-, 16- and 32bit), Graphics Controllers
Datasheets and Hardware Manuals, Support Tools (Hard- and Software)

<http://www.fujitsu.com/emea/services/microelectronics/>

Automotive products: MCU, Graphic display controller, MPEG en/decoder, gyro sensors

<http://www.fujitsu.com/emea/services/industries/automotive/>

Linear Products: Power Management, A/D and D/A Converters

<http://www.fujitsu.com/emea/services/microelectronics/linears/>

Media Products: SAW filters, acoustic resonators and VCOs

<http://www.fujitsu.com/emea/services/microelectronics/saw/>

For more information about FUJITSU MICROELECTRONICS

<http://emea.fujitsu.com/microelectronics>

11.3 Tables

Table 2-1: Jumper settings.....	15
Table 3-1: MCU Operating Mode	19
Table 3-2: FlexRay CC Operating Mode	20
Table 3-3: FlexRay CC SPI Settings	21
Table 3-4: Power Switch	22
Table 3-5: Power supply configurations	22
Table 3-6: Voltage Test Points	23
Table 3-7: MCU Power Supply SK-91F467-FLEXRAY	24
Table 3-8: MCU ADC Supply	25
Table 3-9: FlexRay CC Supply	25
Table 3-10: Power Supply settings for MB88121B	26
Table 3-11: MCU-FlexRay CC Connection.....	28
Table 3-12: FlexRay CH-A Configuration	29
Table 3-13: FlexRay CH-B Configuration	30
Table 3-14: FT1080 Control Settings	31
Table 3-15: FT1080 Connection to MCU.....	31
Table 3-16: CAN-MCU connection.....	32
Table 3-17: UART2 Settings	33
Table 3-18: UART4 Settings	34
Table 3-19: UART5 Settings	35
Table 3-20: User Push Buttons	36
Table 3-21: S4 Values.....	36
Table 3-22: S3 Settings.....	36
Table 3-23: Reset Connections.....	37
Table 3-24: Supply Monitor Settings	37
Table 3-25: Reset UART Selection	38
Table 4-1: UART Connector Signals	39
Table 4-2: CAN Connector Signals	40
Table 4-3: FlexRay Connector Signals.....	40
Table 4-4: FlexRay Physical Layer Modules	41
Table 4-5: LED/LCD Signals	42
Table 4-6: In-Circuit Programming Connector	43
Table 4-7: MCU Pin Connectors	43
Table 4-8: VG96 (X13) Signals	44
Table 4-9: VG48 (X14) Signals	45
Table 5-1: Jumper Settings for 16-bit none-multiplexed parallel bus interface.....	47

Table 5-2: Jumper Settings for 16-bit multiplexed parallel bus interface	48
Table 5-3: Jumper Settings for SPI mode.....	49
Table 6-1: Memory map of Monitor debugger 91460_mondeb_uart4-v11	64
Table 6-2: Linker Settings for MB91F467DA Monitor Debugger configuration.....	65
Table 8-1: Trouble shooting	69
Table 10-1: History PCB V1.0	72
Table 10-2: History PCB V1.1	72

11.4 Figures

Figure 2-1: AC plug adapter	12
Figure 2-2: AC plug adapter selection	12
Figure 2-3: DC voltage selection	12
Figure 2-4: Low voltage adapter selection	12
Figure 2-5: Starter kit status after power on	13
Figure 2-6: Default Jumper Settings	16
Figure 2-7: Softune Workbench start menu location	17
Figure 2-8: Softune Workbench V6 IDE	18
Figure 3-1: MCU Mode Switch	19
Figure 3-2: FlexRay CC Mode Switch	20
Figure 3-3: FlexRay CC SPI-Mode Switch	21
Figure 3-4: Voltage Test Points	23
Figure 3-5: FT1080 Control Switch	31
Figure 4-1: Power Connector	39
Figure 4-2: UART Connector	39
Figure 4-3: CAN Connector	40
Figure 4-4: FlexRay Connector	40
Figure 4-5: FlexRay Physical Layer Connector	41
Figure 4-6: User LEDs / LCD	42
Figure 4-7: In Circuit Programming Connector	43
Figure 4-8: Layout of DIN VG Connectors	45
Figure 6-1: Softune Workbench main window	50
Figure 6-2: Open Softune Workbench workspace (*.wsp)	53
Figure 6-3: Project configuration selection	54
Figure 6-4: Open Softune Workbench Linker mapping file	55
Figure 6-5: Softune Workbench Linker Mapping	55
Figure 6-6: Start Softune Workbench Monitor Debugger	56
Figure 6-7: MB91F467D and mode pin DIP switch	58
Figure 6-8: Reset button and user LED	58
Figure 6-9: SWB debugging window	59
Figure 7-1: FME FR-Flash Programmer for MB91F467D series	66
Figure 7-2: FME Flash Programmer output message window	68
Figure 9-1: Board Layout (Top Side)	70
Figure 9-2: Board Layout (Bottom Side)	71

11.5 Abbreviations

ADC	Analogue Digital Converter
ASSP	Application Specific Standard Product
CAN	Controller Area Network
CC	Communication Controller
CS	Chip Select
FME	Fujitsu Microelectronics Europe GmbH
FPGA	Field Programmable Gate Array
GDC	Graphical Display Controller
LB	Lower Byte
LIN	Local Interconnect Network
MCU	Microcontroller Unit
PCB	Printed Circuit Board
SRAM	Static Random Access Memory
TZM	Transferzentrum Mikroelektronik
UART	Universal Asynchronous Receiver Transmitter
UB	Upper Byte
UG	User Guide
USART	Universal Synchronous Asynchronous Receiver Transmitter

12 China-RoHS regulation

Evaluation Board 评估板

Emulation Board 仿真板

根据SJ/T11364-2006

《电子信息产品污染控制标识要求》特提供如下有关污染控制方面的信息。

The following product pollution control information is provided according to SJ/T11364-2006 *Marking for Control of Pollution caused by Electronic Information Products*.

1. 电子信息产品污染控制标志说明 Explanation of Pollution Control Label



该标志表明本产品含有超过中国标准SJ/T11363-2006

《电子信息产品中有毒有害物质的限量要求》中限量的有毒有害物质。标志中的数字为本产品的环保使用期，表明本产品在正常使用的条件下，有毒有害物质不会发生外泄或突变，用户使用本产品不会对环境造成严重污染或对其人身、财产造成严重损害的期限，单位为年。

为保证所声明的环保使用期限，应按产品手册中所规定的环境条件和方法进行正常使用，并严格遵守产品维修手册中规定的定期维修和保养要求。

产品中的消耗件和某些零部件可能有其单独的环保使用期限标志，并且其环保使用期限有可能比整个产品本身的环保使用期限短。应到期按产品维修程序更换那些消耗件和零部件，以保证所声明的整个产品的环保使用期限。

本产品在使用寿命结束时不可作为普通生活垃圾处理，应被单独收集妥善处理。

请注意：环保使用期限50年的指定不是与产品的耐久力，使用期限或任何担保要求等同的。

This symbol to be added to all EIO sold to China, indicates the product contains hazardous materials in excess of the limits established by the Chinese standard SJ/T11363-2006 *Requirements for Concentration Limits for Certain Hazardous Substances in Electronic Information Products*. The number in the symbol is the Environment-friendly Use Period (EFUP), which indicates the period, starting from the manufacturing date, during which the toxic or hazardous substances or elements contained in electronic information products will not leak or mutate under normal operating conditions so that the use of such electronic information products will not result in any severe environmental pollution, any bodily injury or damage to any assets, the unit of the period is "Year".

In order to maintain the declared EFUP, the product shall be operated normally according to the instructions and environmental conditions as defined in the product manual, and periodic maintenance schedules specified in Product Maintenance Procedures shall be followed strictly.

Consumables or certain parts may have their own label with an EFUP value less than the product. Periodic replacement of those consumables or parts to maintain the declared EFUP shall be done in accordance with the Product Maintenance Procedures.

This product must not be disposed of as unsorted municipal waste, and must be collected separately and handled properly after decommissioning.

Please note: The designation of 10 years EFUP is not to be equated with the durability, use-duration or any warranty-claims of the product.

产品中有毒有害物质或元素的名称及含量

Table of hazardous substances name and concentration

部件名称 Component Name	有毒有害物质或元素 Hazardous substances name					
	铅 (Pb)	汞 (Hg)	镉 (Cd)	六价铬 (Cr(VI))	多溴联苯 (PBB)	多溴二苯醚 (PBDE)
SK-91F467-FlexRay	x	o	o	o	o	o

O: 表示该有毒有害物质在该部件所有均质材料中的含量均在SJ/T11363-2006 标准规定的限量要求以下

X: 表示该有毒有害物质至少在该部件的某一均质材料中的含量超出SJ/T11363-2006 标准规定的限量要求

- 此表所列数据为发布时所能获得的最佳信息
- 由于缺少经济上或技术上合理可行的替代物质或方案，此医疗设备运用以上一些有毒有害物质来实现设备的预期临床功能，或给人员或环境提供更好的保护效果。

O: Indicates that this toxic or hazardous substance contained in all of the homogeneous materials for this part is below the limit requirement in SJ/T11363-2006.

X: Indicates that this toxic or hazardous substance contained in at least one of the homogeneous materials used for this part is above the limit requirement in SJ/T11363-2006.

- Data listed in the table represents best information available at the time of publication

13 Recycling

Gültig für EU-Länder:

Gemäß der Europäischen WEEE-Richtlinie und deren Umsetzung in landesspezifische Gesetze nehmen wir dieses Gerät wieder zurück.

Zur Entsorgung schicken Sie das Gerät bitte an die folgende Adresse:

Fujitsu Microelectronics Europe GmbH
Warehouse/Disposal
Monzastraße 4a
63225 Langen

Valid for European Union Countries:

According to the European WEEE-Directive and its implementation into national laws we take this device back.

For disposal please send the device to the following address:

Fujitsu Microelectronics Europe GmbH
Warehouse/Disposal
Monzastraße 4a
63225 Langen