

REV.	DATE	DESCRIPTION
A	04/04/05	UPDATE DRAWING FORMAT

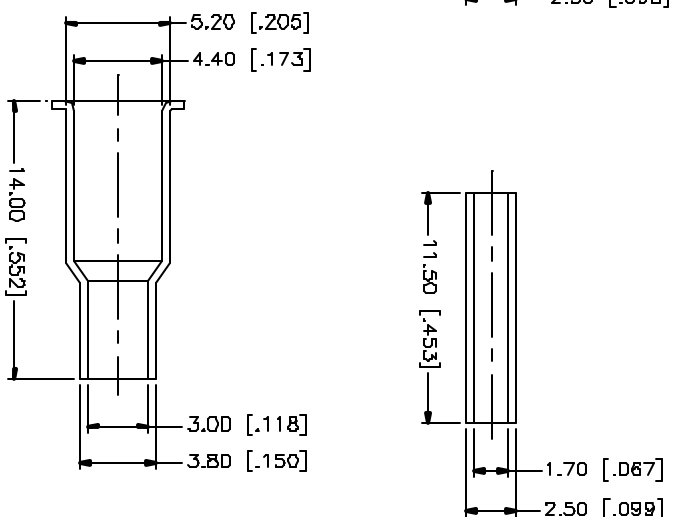
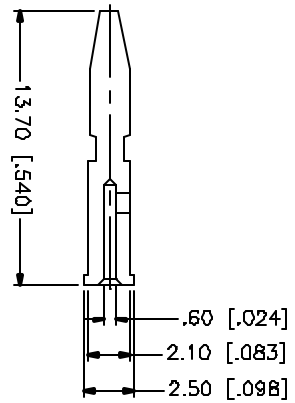
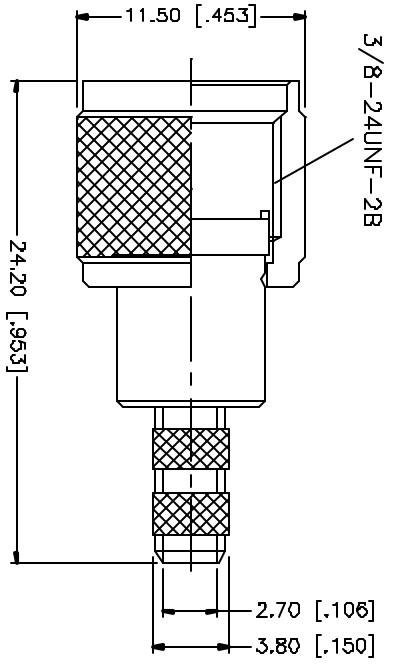
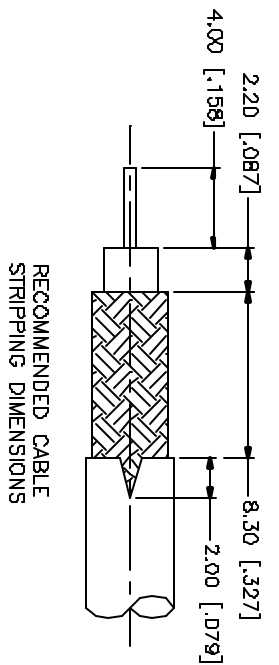

NO.	DESCRIPTION	MATERIAL	FINISH	QTY
8				
7				
6				
5	FERRULE	BRASS	NICKEL	1
4	INSULATOR	DELTRIN	NATURAL	1
3	CONTACT PIN	BRASS	GOLD	1
2	INSULATOR	TEFLON	NATURAL	1
1	BODY	BRASS	NICKEL	1
DESCRIPTION				
MATERIAL				
FINISH				
QTY				
<p>UNLESS OTHERWISE SPECIFIED DIMENSIONS ARE IN INCHES AND FOR PARTS NOT OTHERWISE SPECIFIED DIMENSIONS ARE IN MILLIMETERS ONLY.</p> <p>UNLESS OTHERWISE SPECIFIED DIMENSIONS FOR MILLIMETERS ARE:</p> <p>0.5 - .50mm ± 0.025mm</p> <p>1 - .10mm ± 0.025mm</p> <p>30 - .120mm ± 0.050mm</p> <p>UNLESS OTHERWISE SPECIFIED DIMENSIONS FOR INCHES ARE:</p> <p>.020 - .315 = ± 0.007"</p> <p>.315 - 1.180 = ± 0.015"</p> <p>1.180 - 4.724 = ± 0.020"</p>				
DD NOT SCALE DRAWING				
APPROVALS		DATE		
DRAWN G.R.S.		04/04/05		
CHECKED				
ISSUED				
SHEET 1 OF 1				
PART NO.		182118		
PART DESCRIPTION		MINI-UHF CRIMP PLUG (FOR RG-174/U, 188A/U, 316/U)		
DWN. N/A		182118.DWG		REV. A
REV. A		SIZE A		SCALE NA
C:/182/182118.DWG		DD FILE		

Amphenol Connex