

The μA733M is obsolete and no longer supplied.

- 200-MHz Bandwidth
- 250-kΩ Input Resistance
- Selectable Nominal Amplification of 10, 100, or 400
- No Frequency Compensation Required

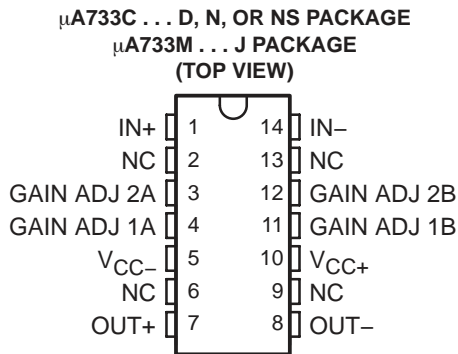

NC — No internal connection

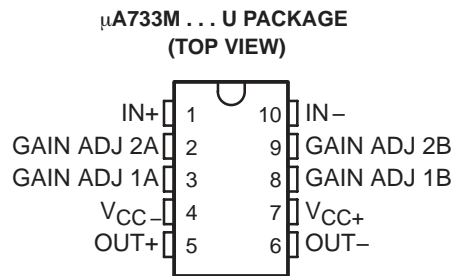

description/ordering information

The μA733 is a monolithic two-stage video amplifier with differential inputs and differential outputs. Internal series-shunt feedback provides wide bandwidth, low phase distortion, and excellent gain stability. Emitter-follower outputs enable the device to drive capacitive loads, and all stages are current-source biased to obtain high common-mode and supply-voltage rejection ratios.

Fixed differential amplification of 10 V/V, 100 V/V, or 400 V/V may be selected without external components, or amplification may be adjusted from 10 V/V to 400 V/V by the use of a single external resistor connected between 1A and 1B. No external frequency-compensating components are required for any gain option.

The device is particularly useful in magnetic-tape or disc-file systems using phase or NRZ encoding and in high-speed thin-film or plated-wire memories. Other applications include general-purpose video and pulse amplifiers where wide bandwidth, low phase shift, and excellent gain stability are required.

The μA733C is characterized for operation from 0°C to 70°C; the μA733M is characterized for operation over the full military temperature range of –55°C to 125°C.

ORDERING INFORMATION

TA	PACKAGE†		ORDERABLE PART NUMBER	TOP-SIDE MARKING
0°C to 70°C	P-DIP (N)	Tube of 25	UA733CN	UA733CN
		Reel of 2500	UA733CDR	UA733C
	SOIC (D)	Tube of 50	UA733CD	UA733C
		Reel of 2500	UA733CDR	UA733C
SOP (NS)	Reel of 2000	UA733CNSR	UA733	

† Package drawings, standard packing quantities, thermal data, symbolization, and PCB design guidelines are available at www.ti.com/sc/package.



Please be aware that an important notice concerning availability, standard warranty, and use in critical applications of Texas Instruments semiconductor products and disclaimers thereto appears at the end of this data sheet.

PRODUCTION DATA information is current as of publication date. Products conform to specifications per the terms of Texas Instruments standard warranty. Production processing does not necessarily include testing of all parameters.

TEXAS
INSTRUMENTS

POST OFFICE BOX 655303 • DALLAS, TEXAS 75265

Copyright © 2004, Texas Instruments Incorporated

μ A733C, μ A733M DIFFERENTIAL VIDEO AMPLIFIERS

The μ A733M is obsolete
and no longer supplied.

SLFS027B – NOVEMBER 1970 – REVISED MAY 2004

symbol

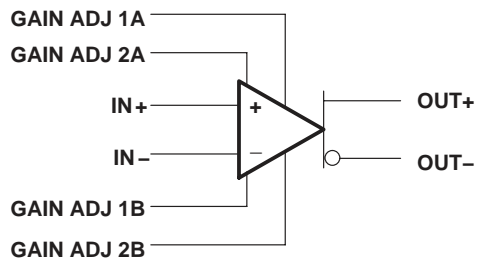

schematic

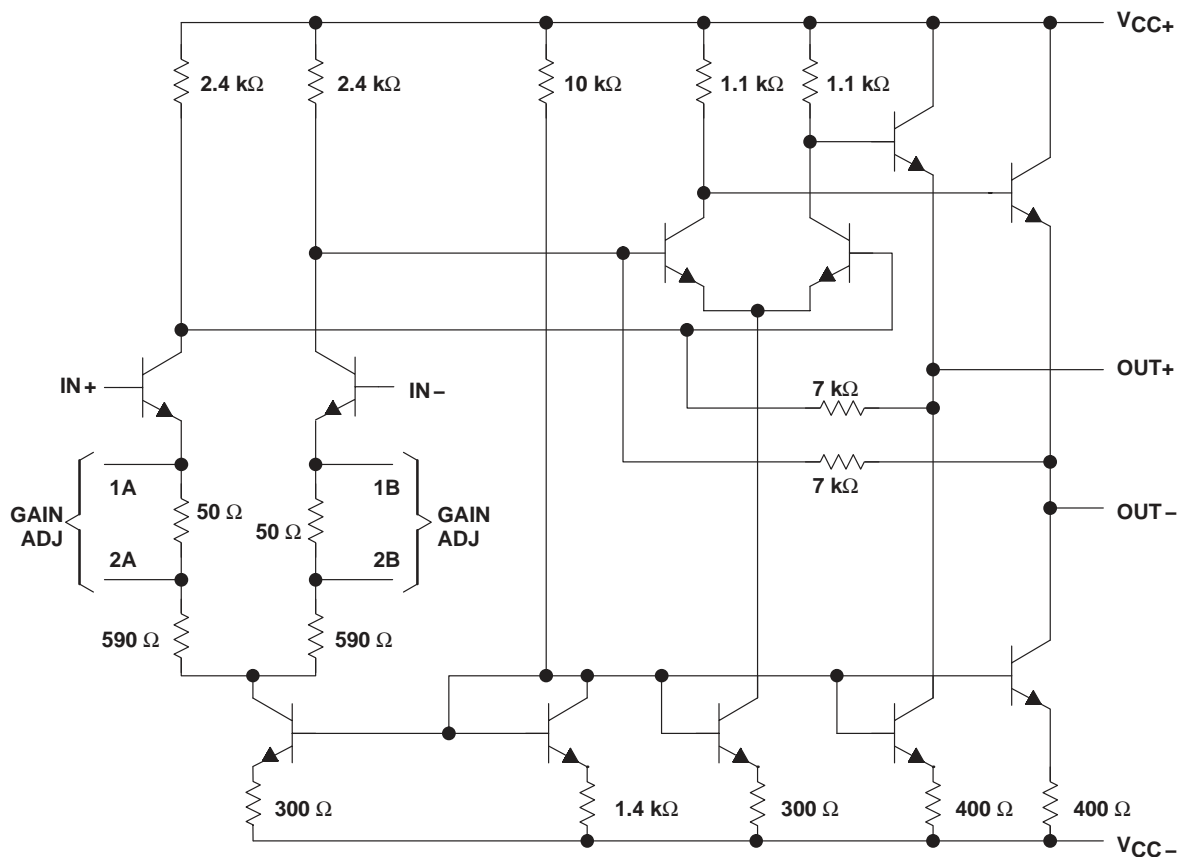

Component values shown are nominal.

The μ A733M is obsolete and no longer supplied.

μ A733C, μ A733M
DIFFERENTIAL VIDEO AMPLIFIERS

SLFS027B – NOVEMBER 1970 – REVISED MAY 2004

absolute maximum ratings over operating free-air temperature range (unless otherwise noted)[†]

	μ A733C	μ A733M	UNIT	
Supply voltage V_{CC+} (see Note 1)	8	8	V	
Supply voltage V_{CC-} (see Note 1)	- 8	- 8	V	
Differential input voltage	± 5	± 5	V	
Common-mode input voltage	± 6	± 6	V	
Output current	10	10	mA	
Continuous total power dissipation	See Dissipation Rating Table			
Package thermal impedance, θ_{JA} (see Notes 2 and 3)	D package	86	°C/W	
	N package	80		
	NS package	76		
Maximum junction temperature, T_J	150		°C	
Lead temperature 1,6 mm (1/16 inch) from case for 60 seconds	J or U package		300	°C
Storage temperature range, T_{stg}	- 65 to 150	- 65 to 150	°C	

[†] Stresses beyond those listed under absolute maximum ratings may cause permanent damage to the device. This is a stress rating only, and functional operation of the device at these or any other conditions beyond those indicated in the recommended operating conditions section of this specification is not implied. Exposure to absolute-maximum-rated conditions for extended periods may affect device reliability.

- NOTES:
1. All voltage values, except differential input voltages, are with respect to the midpoint between V_{CC+} and V_{CC-} .
 2. Maximum power dissipation is a function of $T_J(\max)$, θ_{JA} , and T_A . The maximum allowable power dissipation at any allowable ambient temperature is $PD = (T_J(\max) - T_A)/\theta_{JA}$. Operating at the absolute maximum T_J of 150°C can affect reliability.
 3. The package thermal impedance is calculated in accordance with JESD 51-7.

DISSIPATION RATING TABLE

PACKAGE	$T_A \leq 25^\circ\text{C}$ POWER RATING	DERATING FACTOR	DERATE ABOVE T_A	$T_A = 70^\circ\text{C}$ POWER RATING	$T_A = 125^\circ\text{C}$ POWER RATING
J (μ A733M)	500 mW	11.0 mW/°C	104°C	500 mW	269 mW

μA733C, μA733M DIFFERENTIAL VIDEO AMPLIFIERS

The μA733M is obsolete
and no longer supplied.

SLFS027B – NOVEMBER 1970 – REVISED MAY 2004

electrical characteristics, $V_{CC\pm} = \pm 6\text{ V}$, $T_A = 25^\circ\text{C}$

PARAMETER	FIGURE	TEST CONDITIONS	GAIN OPTION†	μA733C			μA733M			UNIT
				MIN	TYP	MAX	MIN	TYP	MAX	
A _{VD}	1	V _{OD} = 1 V	1	250	400	600	300	400	500	V/V
			2	80	100	120	90	100	110	
			3	8	10	12	9	10	11	
BW	2	R _S = 50 Ω	1	50			50			MHz
			2	90			90			
			3	200			200			
I _{IO}			Any	0.4		5	0.4		3	μA
I _{IB}			Any	9		30	9		20	μA
V _{ICR}	1		Any	±1			±1			V
V _{OC}	1		Any	2.4	2.9	3.4	2.4	2.9	3.4	V
V _{OO}	1		1	0.6		1.5	0.6		1.5	V
			2 & 3	0.35		1.5	0.35		1	
V _{OPP}	1		Any	3	4.7		3	4.7		V
r _i	3	V _{OD} ≤ 1 V	1	4			4			kΩ
			2	10	24		20	24		
			3	250			250			
r _o				20			20			Ω
C _i	3	V _{OD} ≤ 1 V	2	2			2			pF
CMRR	4	V _{IC} = ±1 V, f ≤ 100 kHz	2	60	86		60	86		dB
		V _{IC} = ±1 V, f = 5 MHz	2	70			70			
k _{SVR}	1	ΔV _{CC±} = ±0.5 V	2	50	70		50	70		dB
V _n	5	BW = 1 kHz to 10 MHz	Any	12			12			μV
t _{pd}	2	R _S = 50 Ω, Output voltage step = 1 V	1	7.5			7.5			ns
			2	6.0	10		6.0	10		
			3	3.6			3.6			
t _r	2	R _S = 50 Ω, Output voltage step = 1 V	1	10.5			10.5			ns
			2	4.5	12		4.5	10		
			3	2.5			2.5			
I _{sink(max)}			Any	2.5	3.6		2.5	3.6		mA
I _{CC}		No load, No signal	Any	16	24		16	24		mA

† The gain option is selected as follows:

Gain Option 1: Gain-adjust pin 1A is connected to pin 1B, and pins 2A and 2B are open.

Gain Option 2: Gain-adjust pin 1A and pin 1B are open, pin 2A is connected to pin 2B.

Gain Option 3: All four gain-adjust pins are open.



The μ A733M is obsolete
and no longer supplied.

μ A733C, μ A733M
DIFFERENTIAL VIDEO AMPLIFIERS

SLFS027B – NOVEMBER 1970 – REVISED MAY 2004

electrical characteristics, $V_{CC\pm} = \pm 6$ V, $T_A = 0^\circ\text{C}$ to 70°C for μ A733C, -55°C to 125°C for μ A733M

PARAMETER	FIGURE	TEST CONDITIONS	GAIN OPTION†	μ A733C		μ A733M		UNIT	
				MIN	MAX	MIN	MAX		
A_{VD}	Large-signal differential voltage amplification	1	$V_{OD} = 1$ V	1	250	600	200	600	V/V
				2	80	120	80	120	
				3	8	12	8	12	
I_{IO}	Input offset current			Any		6		5	μ A
I_{IB}	Input bias current			Any		40		40	μ A
V_{ICR}	Common-mode input voltage range	1		Any	± 1		± 1		V
V_{OO}	Output offset voltage	1		1		1.5		1.5	V
				2 & 3		1.5		1.2	
V_{OPP}	Maximum peak-to-peak output voltage swing	1		Any	2.8		2.5		V
r_i	Input resistance	3	$V_{OD} \leq 1$ V	2	8		8		k Ω
CMRR	Common-mode rejection ratio	4	$V_{IC} = +1$ V, $f \leq 100$ kHz	2	50		50		dB
k_{SVR}	Supply voltage rejection ratio ($\Delta V_{CC}/\Delta V_{IO}$)	1	$\Delta V_{CC\pm} = \pm 0.5$ V	2	50		50		dB
$I_{sink(max)}$	Maximum output sink current			Any	2.5		2.2		mA
I_{CC}	Supply current		No load, No signal	Any		27		27	mA

† The gain option is selected as follows:

- Gain Option 1: Gain-adjust pin 1A is connected to pin 1B, and pins 2A and 2B are open.
- Gain Option 2: Gain-adjust pin 1A and pin 1B are open, pin 2A is connected to pin 2B.
- Gain Option 3: All four gain-adjust pins are open.

PARAMETER MEASUREMENT INFORMATION

test circuits

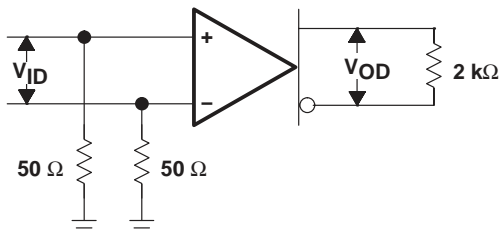

Figure 1

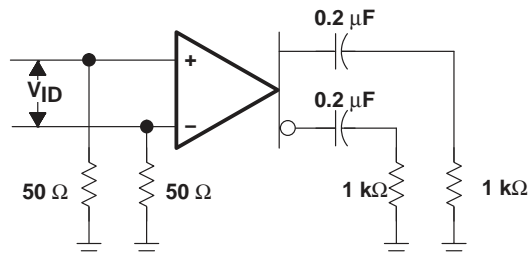

Figure 2

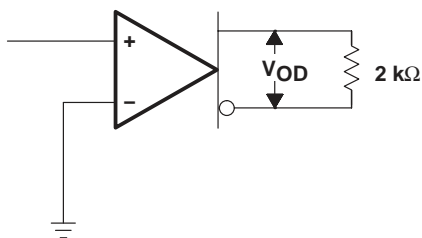

Figure 3

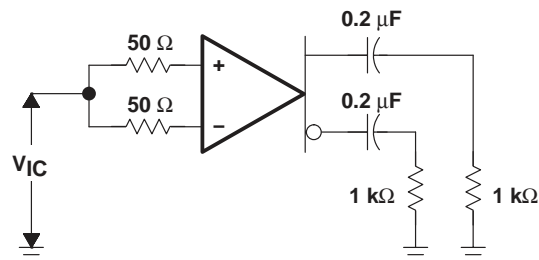

Figure 4

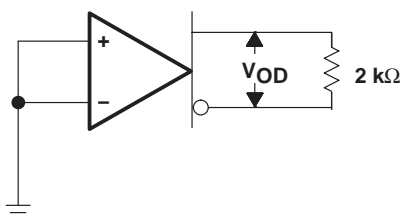
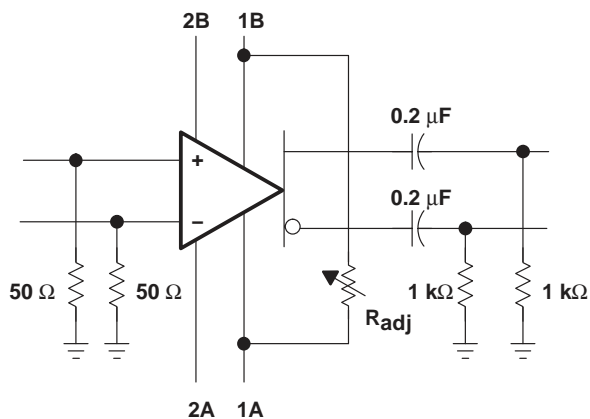

Figure 5



VOLTAGE AMPLIFICATION ADJUSTMENT

Figure 6

TYPICAL CHARACTERISTICS

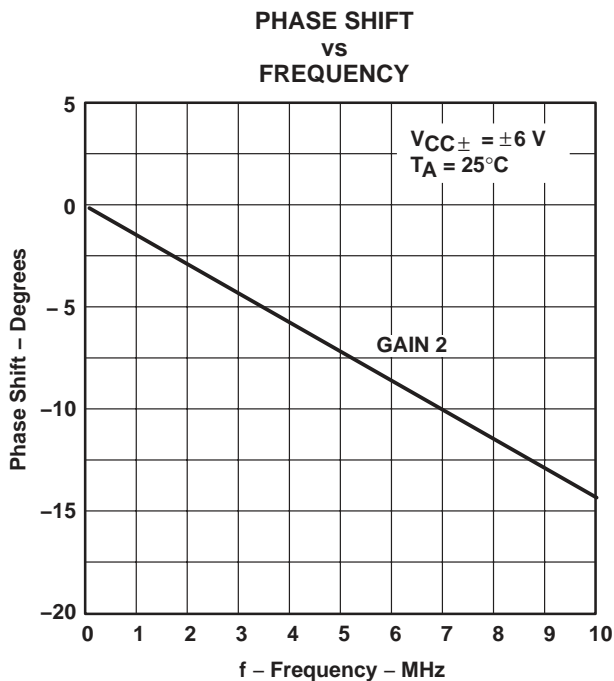

Figure 7

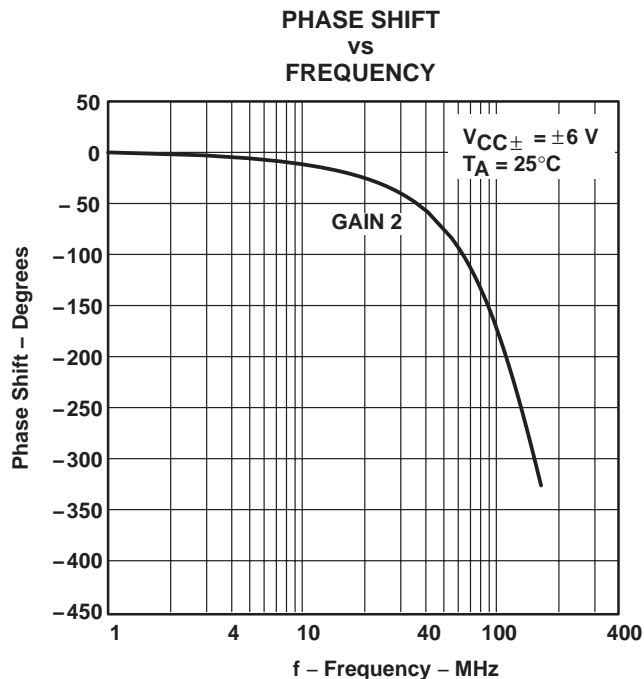

Figure 8

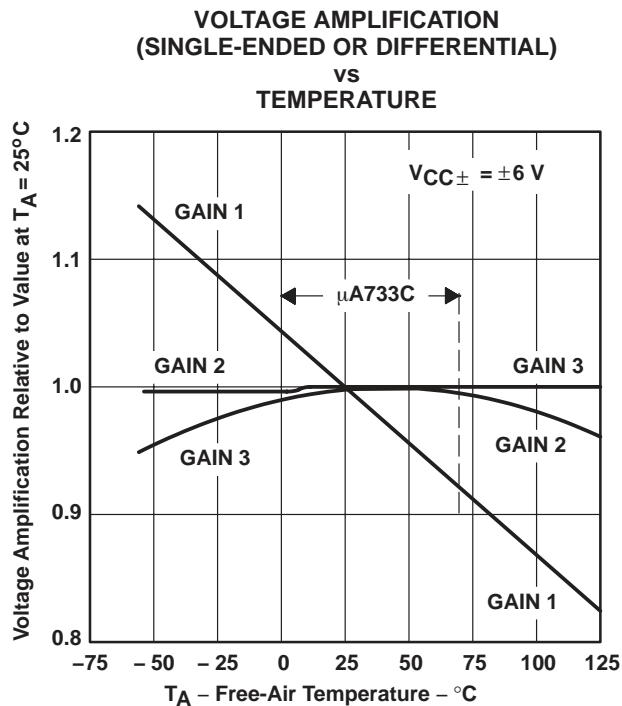

Figure 9

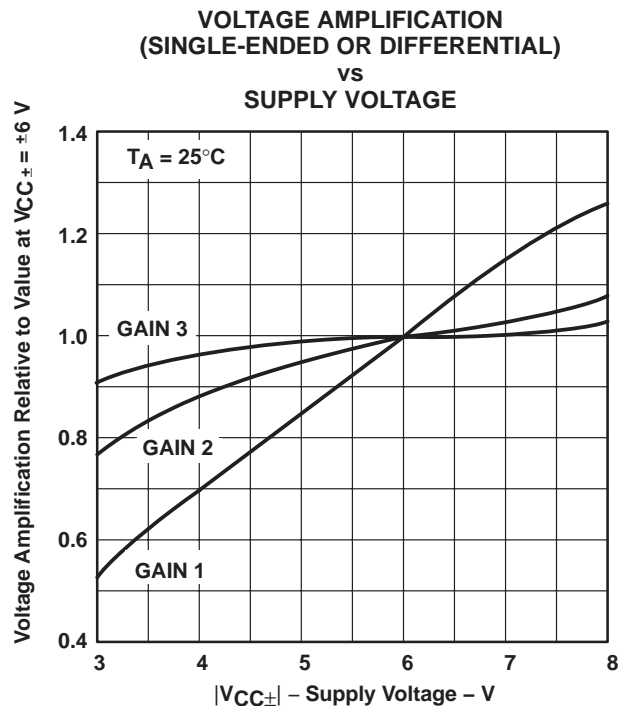

Figure 10

TYPICAL CHARACTERISTICS

**DIFFERENTIAL VOLTAGE AMPLIFICATION
 vs
 RESISTANCE BETWEEN G1A AND G1B**

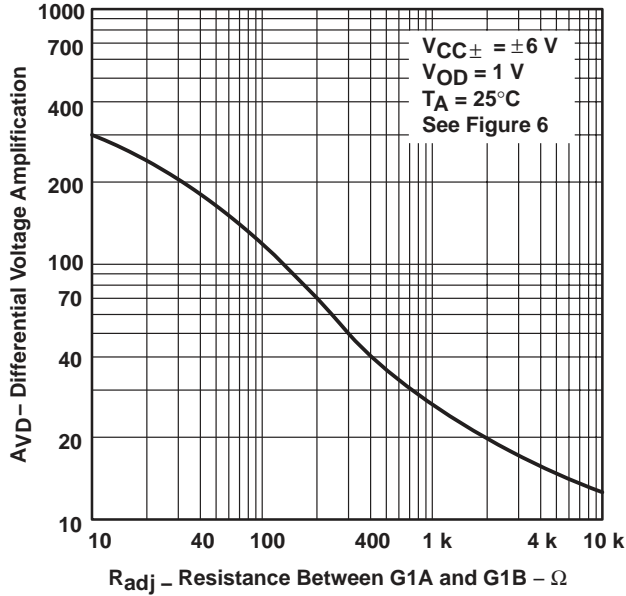

Figure 11

**SINGLE-ENDED VOLTAGE AMPLIFICATION
 vs
 FREQUENCY**

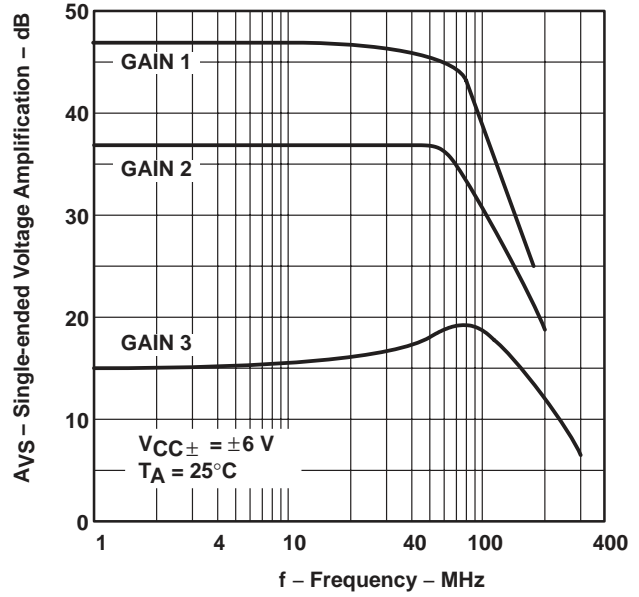

Figure 12

**SUPPLY CURRENT
 vs
 FREE-AIR TEMPERATURE**

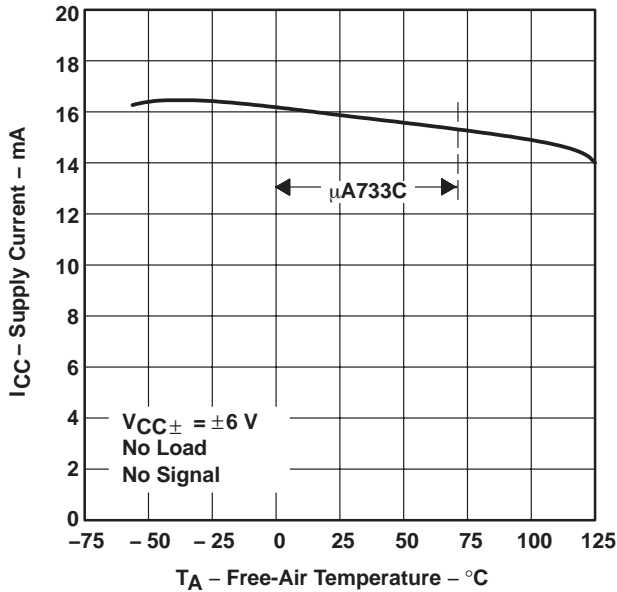

Figure 13

**SUPPLY CURRENT
 vs
 SUPPLY VOLTAGE**

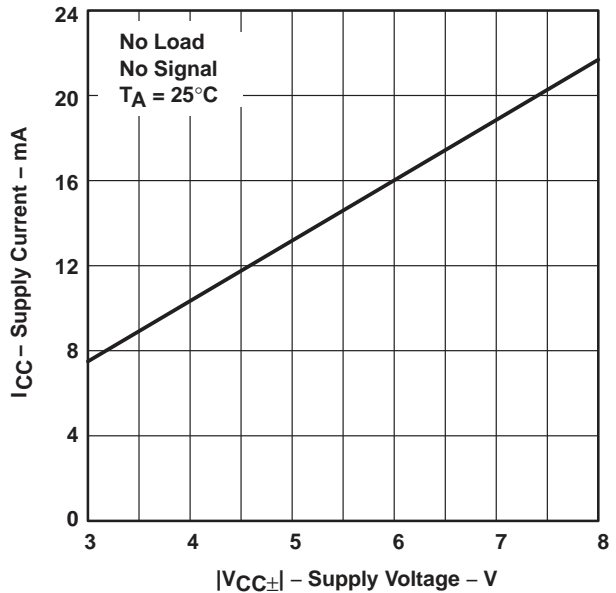

Figure 14

TYPICAL CHARACTERISTICS

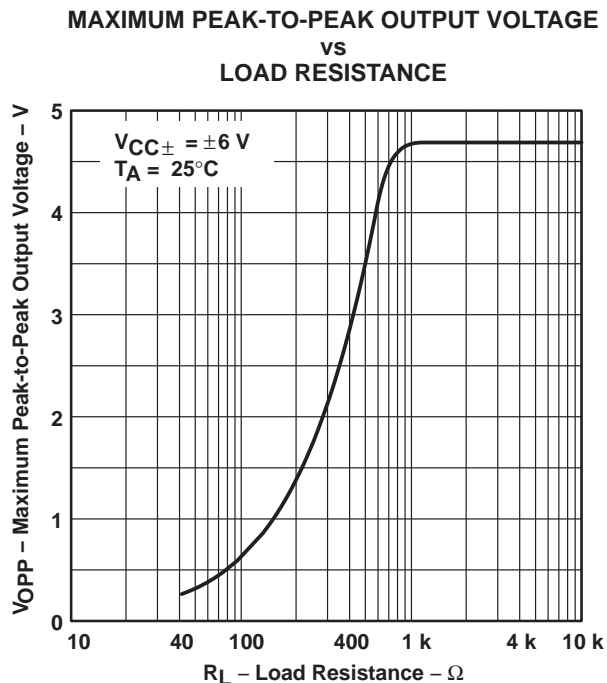

Figure 15

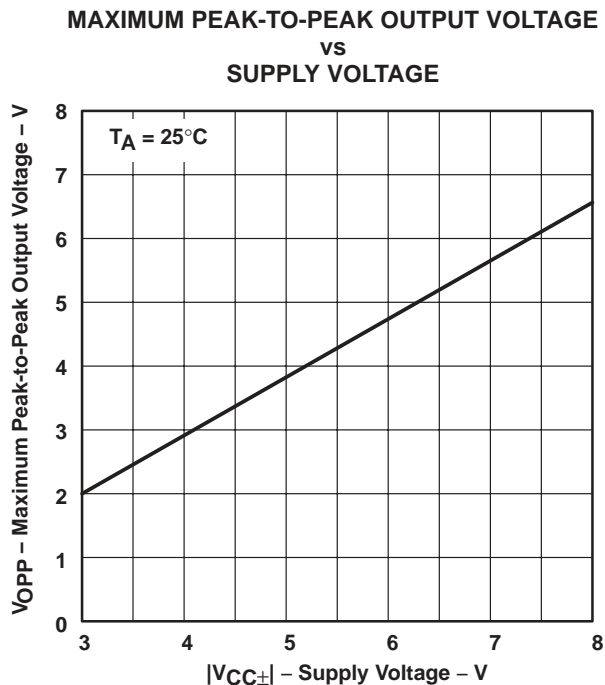

Figure 16

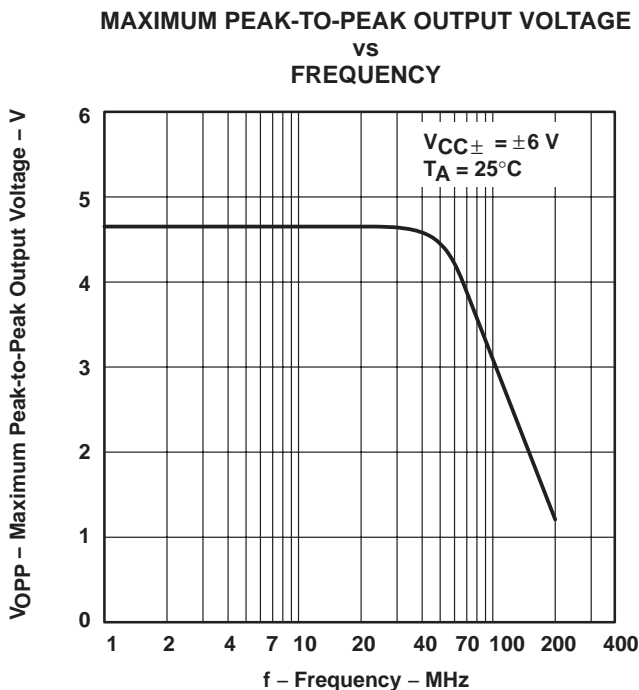

Figure 17

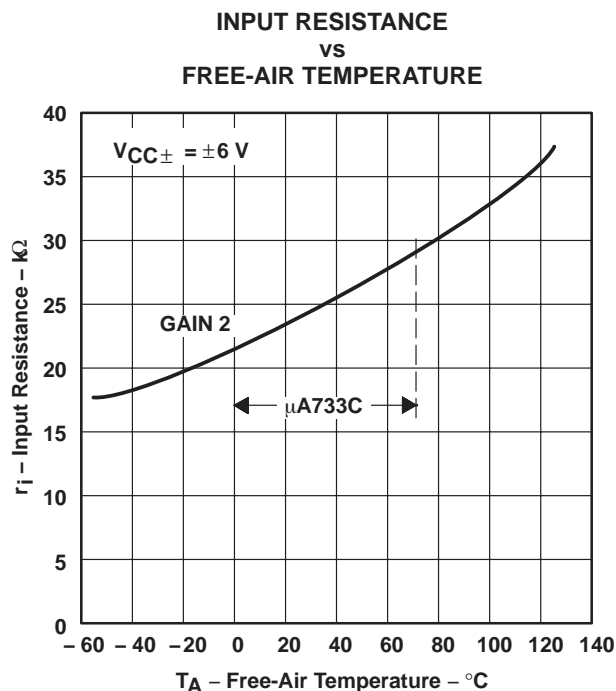

Figure 18

PACKAGING INFORMATION

Orderable Device	Status (1)	Package Type	Package Drawing	Pins	Package Qty	Eco Plan (2)	Lead finish/ Ball material (6)	MSL Peak Temp (3)	Op Temp (°C)	Device Marking (4/5)	Samples
UA733CD	ACTIVE	SOIC	D	14	50	RoHS & Green	NIPDAU	Level-1-260C-UNLIM	0 to 70	UA733C	Samples
UA733CDR	ACTIVE	SOIC	D	14	2500	RoHS & Green	NIPDAU	Level-1-260C-UNLIM	0 to 70	UA733C	Samples
UA733CN	ACTIVE	PDIP	N	14	25	RoHS & Green	NIPDAU	N / A for Pkg Type	0 to 70	UA733CN	Samples
UA733CNSR	ACTIVE	SO	NS	14	2000	RoHS & Green	NIPDAU	Level-1-260C-UNLIM	0 to 70	UA733	Samples

(1) The marketing status values are defined as follows:

ACTIVE: Product device recommended for new designs.

LIFEBUY: TI has announced that the device will be discontinued, and a lifetime-buy period is in effect.

NRND: Not recommended for new designs. Device is in production to support existing customers, but TI does not recommend using this part in a new design.

PREVIEW: Device has been announced but is not in production. Samples may or may not be available.

OBSELETE: TI has discontinued the production of the device.

(2) **RoHS:** TI defines "RoHS" to mean semiconductor products that are compliant with the current EU RoHS requirements for all 10 RoHS substances, including the requirement that RoHS substance do not exceed 0.1% by weight in homogeneous materials. Where designed to be soldered at high temperatures, "RoHS" products are suitable for use in specified lead-free processes. TI may reference these types of products as "Pb-Free".

RoHS Exempt: TI defines "RoHS Exempt" to mean products that contain lead but are compliant with EU RoHS pursuant to a specific EU RoHS exemption.

Green: TI defines "Green" to mean the content of Chlorine (Cl) and Bromine (Br) based flame retardants meet JS709B low halogen requirements of <=1000ppm threshold. Antimony trioxide based flame retardants must also meet the <=1000ppm threshold requirement.

(3) MSL, Peak Temp. - The Moisture Sensitivity Level rating according to the JEDEC industry standard classifications, and peak solder temperature.

(4) There may be additional marking, which relates to the logo, the lot trace code information, or the environmental category on the device.

(5) Multiple Device Markings will be inside parentheses. Only one Device Marking contained in parentheses and separated by a "-" will appear on a device. If a line is indented then it is a continuation of the previous line and the two combined represent the entire Device Marking for that device.

(6) Lead finish/Ball material - Orderable Devices may have multiple material finish options. Finish options are separated by a vertical ruled line. Lead finish/Ball material values may wrap to two lines if the finish value exceeds the maximum column width.

Important Information and Disclaimer:The information provided on this page represents TI's knowledge and belief as of the date that it is provided. TI bases its knowledge and belief on information provided by third parties, and makes no representation or warranty as to the accuracy of such information. Efforts are underway to better integrate information from third parties. TI has taken and

continues to take reasonable steps to provide representative and accurate information but may not have conducted destructive testing or chemical analysis on incoming materials and chemicals. TI and TI suppliers consider certain information to be proprietary, and thus CAS numbers and other limited information may not be available for release.

In no event shall TI's liability arising out of such information exceed the total purchase price of the TI part(s) at issue in this document sold by TI to Customer on an annual basis.

TAPE AND REEL INFORMATION

QUADRANT ASSIGNMENTS FOR PIN 1 ORIENTATION IN TAPE



*All dimensions are nominal

Device	Package Type	Package Drawing	Pins	SPQ	Reel Diameter (mm)	Reel Width W1 (mm)	A0 (mm)	B0 (mm)	K0 (mm)	P1 (mm)	W (mm)	Pin1 Quadrant
UA733CDR	SOIC	D	14	2500	330.0	16.4	6.5	9.0	2.1	8.0	16.0	Q1
UA733CNSR	SO	NS	14	2000	330.0	16.4	8.2	10.5	2.5	12.0	16.0	Q1

TAPE AND REEL BOX DIMENSIONS

*All dimensions are nominal

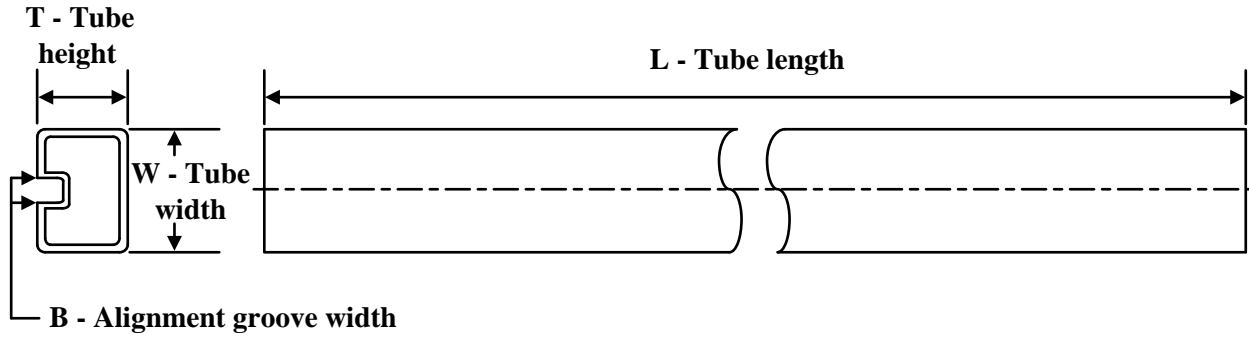
Device	Package Type	Package Drawing	Pins	SPQ	Length (mm)	Width (mm)	Height (mm)
UA733CDR	SOIC	D	14	2500	356.0	356.0	35.0
UA733CNSR	SO	NS	14	2000	356.0	356.0	35.0

TUBE

*All dimensions are nominal

Device	Package Name	Package Type	Pins	SPQ	L (mm)	W (mm)	T (μm)	B (mm)
UA733CD	D	SOIC	14	50	506.6	8	3940	4.32
UA733CN	N	PDIP	14	25	506	13.97	11230	4.32

MECHANICAL DATA

NS (R-PDSO-G**)

PLASTIC SMALL-OUTLINE PACKAGE

14-PINS SHOWN





- NOTES:
- A. All linear dimensions are in millimeters.
 - B. This drawing is subject to change without notice.
 - C. Body dimensions do not include mold flash or protrusion, not to exceed 0,15.

D (R-PDSO-G14)

PLASTIC SMALL OUTLINE



- NOTES:
- A. All linear dimensions are in inches (millimeters).
 - B. This drawing is subject to change without notice.
 -  Body length does not include mold flash, protrusions, or gate burrs. Mold flash, protrusions, or gate burrs shall not exceed 0.006 (0,15) each side.
 -  Body width does not include interlead flash. Interlead flash shall not exceed 0.017 (0,43) each side.
 - E. Reference JEDEC MS-012 variation AB.

D (R-PDSO-G14)

PLASTIC SMALL OUTLINE

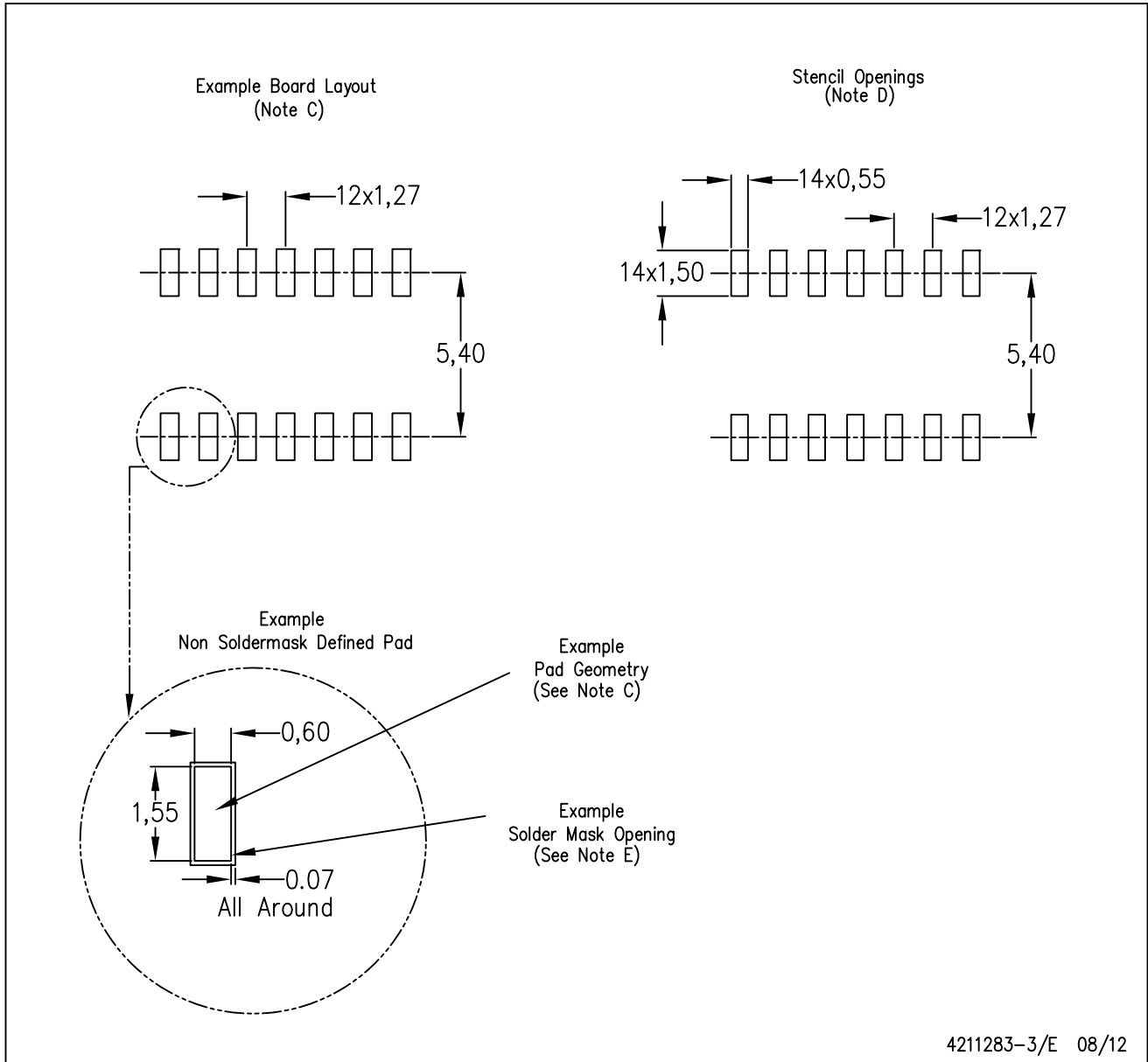

4211283-3/E 08/12

- NOTES:
- All linear dimensions are in millimeters.
 - This drawing is subject to change without notice.
 - Publication IPC-7351 is recommended for alternate designs.
 - Laser cutting apertures with trapezoidal walls and also rounding corners will offer better paste release. Customers should contact their board assembly site for stencil design recommendations. Refer to IPC-7525 for other stencil recommendations.
 - Customers should contact their board fabrication site for solder mask tolerances between and around signal pads.

N (R-PDIP-T**)

PLASTIC DUAL-IN-LINE PACKAGE

16 PINS SHOWN



- NOTES:
- A. All linear dimensions are in inches (millimeters).
 - B. This drawing is subject to change without notice.
 - C Falls within JEDEC MS-001, except 18 and 20 pin minimum body length (Dim A).
 - D The 20 pin end lead shoulder width is a vendor option, either half or full width.

4040049/E 12/2002

IMPORTANT NOTICE AND DISCLAIMER

TI PROVIDES TECHNICAL AND RELIABILITY DATA (INCLUDING DATA SHEETS), DESIGN RESOURCES (INCLUDING REFERENCE DESIGNS), APPLICATION OR OTHER DESIGN ADVICE, WEB TOOLS, SAFETY INFORMATION, AND OTHER RESOURCES "AS IS" AND WITH ALL FAULTS, AND DISCLAIMS ALL WARRANTIES, EXPRESS AND IMPLIED, INCLUDING WITHOUT LIMITATION ANY IMPLIED WARRANTIES OF MERCHANTABILITY, FITNESS FOR A PARTICULAR PURPOSE OR NON-INFRINGEMENT OF THIRD PARTY INTELLECTUAL PROPERTY RIGHTS.

These resources are intended for skilled developers designing with TI products. You are solely responsible for (1) selecting the appropriate TI products for your application, (2) designing, validating and testing your application, and (3) ensuring your application meets applicable standards, and any other safety, security, regulatory or other requirements.

These resources are subject to change without notice. TI grants you permission to use these resources only for development of an application that uses the TI products described in the resource. Other reproduction and display of these resources is prohibited. No license is granted to any other TI intellectual property right or to any third party intellectual property right. TI disclaims responsibility for, and you will fully indemnify TI and its representatives against, any claims, damages, costs, losses, and liabilities arising out of your use of these resources.

TI's products are provided subject to [TI's Terms of Sale](#) or other applicable terms available either on ti.com or provided in conjunction with such TI products. TI's provision of these resources does not expand or otherwise alter TI's applicable warranties or warranty disclaimers for TI products.

TI objects to and rejects any additional or different terms you may have proposed.

Mailing Address: Texas Instruments, Post Office Box 655303, Dallas, Texas 75265
Copyright © 2022, Texas Instruments Incorporated