

# SN54ACT16373, 74ACT16373 16-BIT D-TYPE TRANSPARENT LATCHES WITH 3-STATE OUTPUTS

SCAS122C – MARCH 1990 – REVISED SEPTEMBER 1996

- Members of the Texas Instruments *Widebus*™ Family
- Inputs Are TTL-Voltage Compatible
- 3-State Bus Driving True Outputs
- Full Parallel Access for Loading
- Flow-Through Architecture Optimizes PCB Layout
- Distributed V<sub>CC</sub> and GND Pin Configuration Minimizes High-Speed Switching Noise
- *EPIC*™ (Enhanced-Performance Implanted CMOS) 1-μm Process
- 500-mA Typical Latch-Up Immunity at 125°C
- Package Options Include Shrink Small-Outline (DL) 300-mil Packages Using 25-mil Center-to-Center Pin Spacings and 380-mil Fine-Pitch Ceramic Flat (WD) Packages Using 25-mil Center-to-Center Pin Spacings

SN54ACT16373 . . . WD PACKAGE  
74ACT16373 . . . DL PACKAGE  
(TOP VIEW)

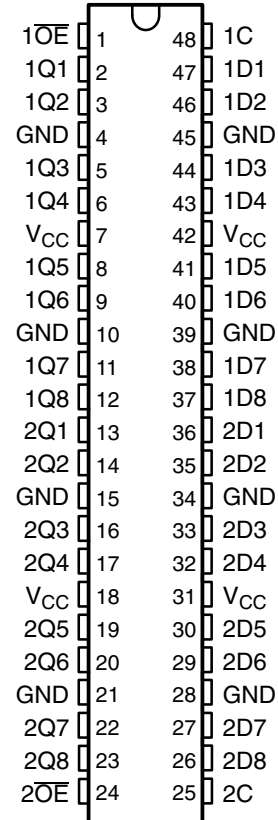

## description

The SN54ACT16373 and 74ACT16373 are 16-bit D-type transparent latches with 3-state outputs designed specifically for driving highly capacitive or relatively low-impedance loads. They are particularly suitable for implementing buffer registers, I/O ports, bidirectional bus drivers, and working registers. These devices can be used as two 8-bit latches or one 16-bit latch. The Q outputs of the latches follow the data (D) inputs if enable C is taken high. When C is taken low, the Q outputs are latched at the levels set up at the D inputs.

A buffered output-enable ( $\overline{OE}$ ) input can be used to place the outputs in either a normal logic state (high or low logic levels) or the high-impedance state. In the high-impedance state, the outputs neither load nor drive the bus lines significantly. The high-impedance state and the increased drive provide the capability to drive bus lines in a bus-organized system without need for interface or pullup components.

$\overline{OE}$  does not affect the internal operations of the latches. Old data can be retained or new data can be entered while the outputs are in the high-impedance state.

The 74ACT16373 is packaged in TI's shrink small-outline package, which provides twice the I/O pin count and functionality of standard small-outline packages in the same printed-circuit-board area.

The SN54ACT16373 is characterized for operation over the full military temperature range of -55°C to 125°C. The 74ACT16373 is characterized for operation from -40°C to 85°C.



Please be aware that an important notice concerning availability, standard warranty, and use in critical applications of Texas Instruments semiconductor products and disclaimers thereto appears at the end of this data sheet.

EPIC and Widebus are trademarks of Texas Instruments Incorporated.

PRODUCTION DATA information is current as of publication date. Products conform to specifications per the terms of Texas Instruments standard warranty. Production processing does not necessarily include testing of all parameters.

 **TEXAS  
INSTRUMENTS**

POST OFFICE BOX 655303 • DALLAS, TEXAS 75265

Copyright © 1996, Texas Instruments Incorporated

# SN54ACT16373, 74ACT16373 16-BIT D-TYPE TRANSPARENT LATCHES WITH 3-STATE OUTPUTS

SCAS122C – MARCH 1990 – REVISED SEPTEMBER 1996

FUNCTION TABLE

INPUTS			OUTPUT
OE	C	D	Q
L	H	H	H
L	H	L	L
L	L	X	Q <sub>0</sub>
H	X	X	Z

logic symbol†

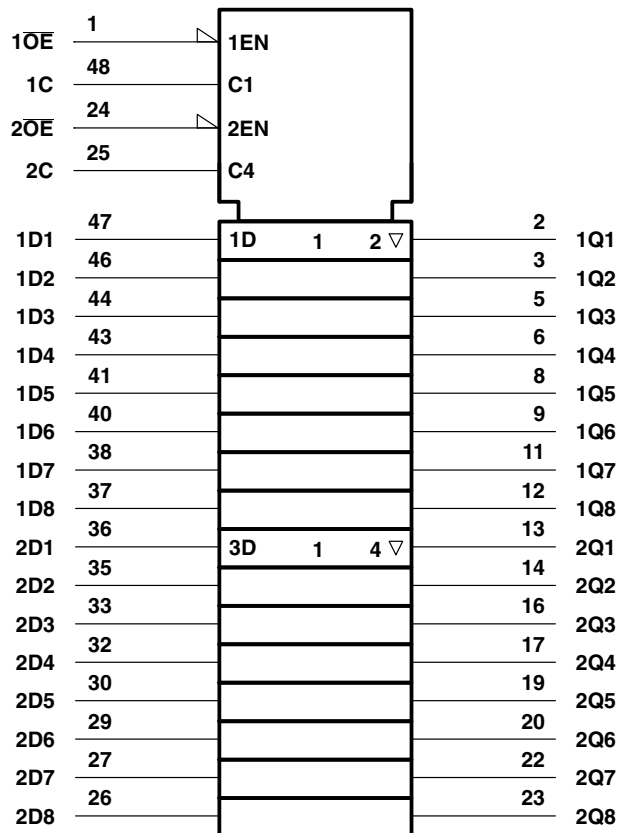

† This symbol is in accordance with ANSI/IEEE Std 91-1984 and IEC Publication 617-12.

# SN54ACT16373, 74ACT16373 16-BIT D-TYPE TRANSPARENT LATCHES WITH 3-STATE OUTPUTS

SCAS122C – MARCH 1990 – REVISED SEPTEMBER 1996

## logic diagram (positive logic)

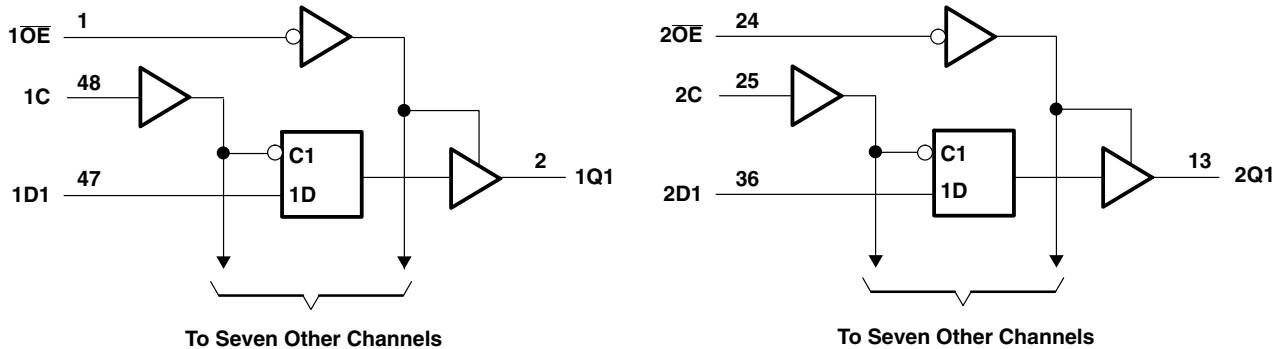

## absolute maximum ratings over operating free-air temperature range (unless otherwise noted)<sup>†</sup>

Supply voltage range, $V_{CC}$ .....	-0.5 V to 7 V
Input voltage range, $V_I$ (see Note 1) .....	-0.5 V to $V_{CC} + 0.5$ V
Output voltage range, $V_O$ (see Note 1) .....	-0.5 V to $V_{CC} + 0.5$ V
Input clamp current, $I_{IK}$ ( $V_I < 0$ or $V_I > V_{CC}$ ) .....	$\pm 20$ mA
Output clamp current, $I_{OK}$ ( $V_O < 0$ or $V_O > V_{CC}$ ) .....	$\pm 50$ mA
Continuous output current, $I_O$ ( $V_O = 0$ to $V_{CC}$ ) .....	$\pm 50$ mA
Continuous current through $V_{CC}$ or GND .....	$\pm 400$ mA
Maximum power dissipation at $T_A = 55^\circ\text{C}$ (in still air) (see Note 2): DL package .....	1.2 W
Storage temperature range, $T_{stg}$ .....	$-65^\circ\text{C}$ to $150^\circ\text{C}$

<sup>†</sup> Stresses beyond those listed under "absolute maximum ratings" may cause permanent damage to the device. These are stress ratings only, and functional operation of the device at these or any other conditions beyond those indicated under "recommended operating conditions" is not implied. Exposure to absolute-maximum-rated conditions for extended periods may affect device reliability.

- NOTES: 1. The input and output voltage ratings may be exceeded if the input and output current ratings are observed.  
2. The maximum package power dissipation is calculated using a junction temperature of  $150^\circ\text{C}$  and a board trace length of 750 mils.

## recommended operating conditions (see Note 3)

		SN54ACT16373		74ACT16373		UNIT
		MIN	MAX	MIN	MAX	
$V_{CC}$	Supply voltage (see Note 4)	4.5	5.5	4.5	5.5	V
$V_{IH}$	High-level input voltage	2		2		V
$V_{IL}$	Low-level input voltage		0.8		0.8	V
$V_I$	Input voltage	0	$V_{CC}$	0	$V_{CC}$	V
$V_O$	Output voltage	0	$V_{CC}$	0	$V_{CC}$	V
$I_{OH}$	High-level output current		-24		-24	mA
$I_{OL}$	Low-level output current		24		24	mA
$\Delta t/\Delta v$	Input transition rise or fall rate	0	10	0	10	ns/V
$T_A$	Operating free-air temperature	-55	125	-40	85	$^\circ\text{C}$

- NOTES: 3. Unused inputs should be tied to  $V_{CC}$  through a pullup resistor of approximately 5 k $\Omega$  or greater to prevent them from floating.  
4. All  $V_{CC}$  and GND pins must be connected to the proper voltage supply.

# SN54ACT16373, 74ACT16373 16-BIT D-TYPE TRANSPARENT LATCHES WITH 3-STATE OUTPUTS

SCAS122C – MARCH 1990 – REVISED SEPTEMBER 1996

electrical characteristics over recommended operating free-air temperature range (unless otherwise noted)

PARAMETER	TEST CONDITIONS	V <sub>CC</sub>	T <sub>A</sub> = 25°C			SN54ACT16373		74ACT16373		UNIT
			MIN	TYP	MAX	MIN	MAX	MIN	MAX	
V <sub>OH</sub>	I <sub>OH</sub> = -50 μA	4.5 V	4.4			4.4		4.4	V	
		5.5 V	5.4			5.4		5.4		
	I <sub>OH</sub> = -24 mA	4.5 V	3.94			3.7		3.8		
		5.5 V	4.94			4.7		4.8		
	I <sub>OH</sub> = -50 mA <sup>†</sup>	5.5 V				3.85				
I <sub>OH</sub> = -75 mA <sup>†</sup>	5.5 V						3.85			
V <sub>OL</sub>	I <sub>OL</sub> = 50 μA	4.5 V			0.1		0.1	0.1	V	
		5.5 V			0.1		0.1	0.1		
	I <sub>OL</sub> = 24 mA	4.5 V			0.36		0.5	0.44		
		5.5 V			0.36		0.5	0.44		
	I <sub>OL</sub> = 50 mA <sup>†</sup>	5.5 V					1.65			
I <sub>OL</sub> = 75 mA <sup>†</sup>	5.5 V						1.65			
I <sub>I</sub>	V <sub>I</sub> = V <sub>CC</sub> or GND	5.5 V			±0.1		±1	±1	μA	
I <sub>OZ</sub>	V <sub>O</sub> = V <sub>CC</sub> or GND	5.5 V			±0.5		±10	±5	μA	
I <sub>CC</sub>	V <sub>I</sub> = V <sub>CC</sub> or GND, I <sub>O</sub> = 0	5.5 V			8		160	80	μA	
ΔI <sub>CC</sub> <sup>‡</sup>	One input at 3.4 V, Other inputs at GND or V <sub>CC</sub>	5.5 V			0.9		1	1	mA	
C <sub>i</sub>	V <sub>I</sub> = V <sub>CC</sub> or GND	5 V			4.5				pF	
C <sub>o</sub>	V <sub>I</sub> = V <sub>CC</sub> or GND	5 V			12				pF	

<sup>†</sup> Not more than one output should be tested at a time, and the duration of the test should not exceed 10 ms.

<sup>‡</sup> This is the increase in supply current for each input that is at one of the specified TTL voltage levels rather than 0 V to V<sub>CC</sub>.

timing requirements over recommended ranges of supply voltage and operating free-air temperature (unless otherwise noted) (see Figure 1)

		T <sub>A</sub> = 25°C		SN54ACT16373		74ACT16373		UNIT
		MIN	MAX	MIN	MAX	MIN	MAX	
t <sub>w</sub>	Pulse duration, LE high	4		4		1		ns
t <sub>su</sub>	Setup time, data before LE↓	1		1		1		ns
t <sub>h</sub>	Hold time, data after LE↓	5		5		5		ns

switching characteristics over recommended ranges of supply voltage and operating free-air temperature (unless otherwise noted) (see Figure 1)

PARAMETER	FROM (INPUT)	TO (OUTPUT)	T <sub>A</sub> = 25°C			SN54ACT16373		74ACT16373		UNIT
			MIN	TYP	MAX	MIN	MAX	MIN	MAX	
t <sub>PLH</sub>	D	Q	3.8	7.9	9.4	3.8	11.8	3.8	11.1	ns
t <sub>PHL</sub>			3.1	8.2	9.7	3.1	13	3.1	12.3	
t <sub>PLH</sub>	LE	Q	4.6	9.3	10.8	4.6	13.7	4.6	12.8	ns
t <sub>PHL</sub>			4.5	9.1	10.5	4.5	13	4.5	12.2	
t <sub>PZH</sub>	OE	Q	3.1	8	9.5	3.1	13	3.1	12.1	ns
t <sub>PZL</sub>			3.8	9.4	11.1	3.8	15.1	3.8	14.2	
t <sub>PHZ</sub>	OE	Q	5.3	8.6	9.9	5.3	11	5.3	10.7	ns
t <sub>PLZ</sub>			4.3	7.4	8.7	4.3	9.8	4.3	9.4	



# SN54ACT16373, 74ACT16373 16-BIT D-TYPE TRANSPARENT LATCHES WITH 3-STATE OUTPUTS

SCAS122C – MARCH 1990 – REVISED SEPTEMBER 1996

operating characteristics,  $V_{CC} = 5\text{ V}$ ,  $T_A = 25^\circ\text{C}$

PARAMETER		TEST CONDITIONS	TYP	UNIT
$C_{pd}$	Power dissipation capacitance per latch	Outputs enabled	43	pF
		Outputs disabled	4.5	

## PARAMETER MEASUREMENT INFORMATION

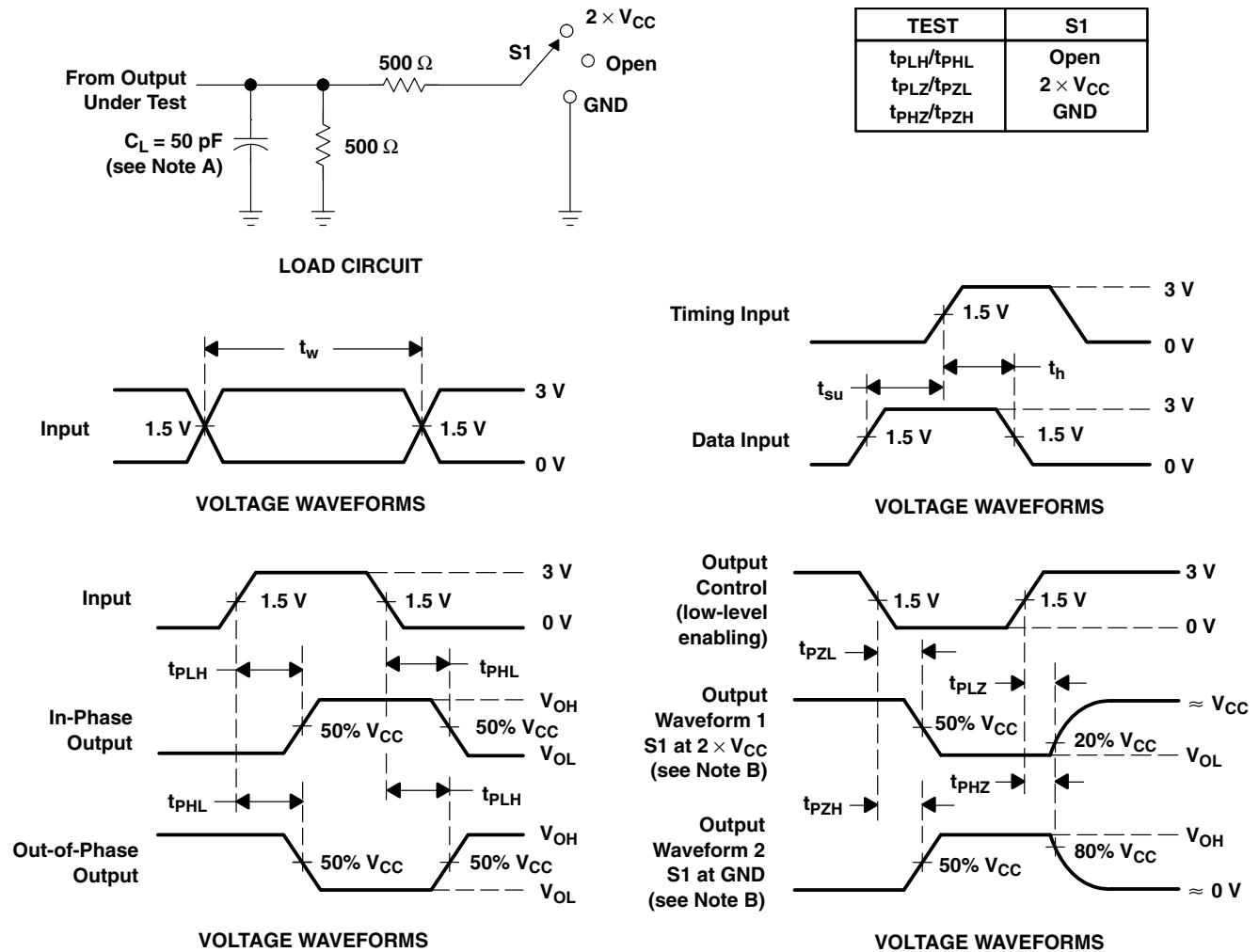

- NOTES: A.  $C_L$  includes probe and jig capacitance.  
 B. Waveform 1 is for an output with internal conditions such that the output is low except when disabled by the output control. Waveform 2 is for an output with internal conditions such that the output is high except when disabled by the output control.  
 C. All input pulses are supplied by generators having the following characteristics:  $PRR \leq 1\text{ MHz}$ ,  $Z_O = 50\ \Omega$ ,  $t_r = 3\text{ ns}$ ,  $t_f = 3\text{ ns}$ .  
 D. The outputs are measured one at a time with one input transition per measurement.

**Figure 1. Load Circuit and Voltage Waveforms**

## PACKAGING INFORMATION

Orderable Device	Status (1)	Package Type	Package Drawing	Pins	Package Qty	Eco Plan (2)	Lead finish/ Ball material (6)	MSL Peak Temp (3)	Op Temp (°C)	Device Marking (4/5)	Samples
5962-9202401MXA	ACTIVE	CFP	WD	48	1	Non-RoHS & Green	SNPB	N / A for Pkg Type	-55 to 125	5962-9202401MX A SNJ54ACT16373W D	<a href="#">Samples</a>
74ACT16373DL	LIFEBUY	SSOP	DL	48	25	RoHS & Green	NIPDAU	Level-1-260C-UNLIM	-40 to 85	ACT16373	
74ACT16373DLR	ACTIVE	SSOP	DL	48	1000	RoHS & Green	NIPDAU	Level-1-260C-UNLIM	-40 to 85	ACT16373	<a href="#">Samples</a>
74ACT16373DLRG4	ACTIVE	SSOP	DL	48	1000	RoHS & Green	NIPDAU	Level-1-260C-UNLIM	-40 to 85	ACT16373	<a href="#">Samples</a>
SNJ54ACT16373WD	ACTIVE	CFP	WD	48	1	Non-RoHS & Green	SNPB	N / A for Pkg Type		5962-9202401MX A SNJ54ACT16373W D	<a href="#">Samples</a>

(1) The marketing status values are defined as follows:

**ACTIVE:** Product device recommended for new designs.

**LIFEBUY:** TI has announced that the device will be discontinued, and a lifetime-buy period is in effect.

**NRND:** Not recommended for new designs. Device is in production to support existing customers, but TI does not recommend using this part in a new design.

**PREVIEW:** Device has been announced but is not in production. Samples may or may not be available.

**OBSELETE:** TI has discontinued the production of the device.

(2) **RoHS:** TI defines "RoHS" to mean semiconductor products that are compliant with the current EU RoHS requirements for all 10 RoHS substances, including the requirement that RoHS substance do not exceed 0.1% by weight in homogeneous materials. Where designed to be soldered at high temperatures, "RoHS" products are suitable for use in specified lead-free processes. TI may reference these types of products as "Pb-Free".

**RoHS Exempt:** TI defines "RoHS Exempt" to mean products that contain lead but are compliant with EU RoHS pursuant to a specific EU RoHS exemption.

**Green:** TI defines "Green" to mean the content of Chlorine (Cl) and Bromine (Br) based flame retardants meet JS709B low halogen requirements of <=1000ppm threshold. Antimony trioxide based flame retardants must also meet the <=1000ppm threshold requirement.

(3) MSL, Peak Temp. - The Moisture Sensitivity Level rating according to the JEDEC industry standard classifications, and peak solder temperature.

(4) There may be additional marking, which relates to the logo, the lot trace code information, or the environmental category on the device.

(5) Multiple Device Markings will be inside parentheses. Only one Device Marking contained in parentheses and separated by a "~" will appear on a device. If a line is indented then it is a continuation of the previous line and the two combined represent the entire Device Marking for that device.

<sup>(6)</sup> Lead finish/Ball material - Orderable Devices may have multiple material finish options. Finish options are separated by a vertical ruled line. Lead finish/Ball material values may wrap to two lines if the finish value exceeds the maximum column width.

**Important Information and Disclaimer:**The information provided on this page represents TI's knowledge and belief as of the date that it is provided. TI bases its knowledge and belief on information provided by third parties, and makes no representation or warranty as to the accuracy of such information. Efforts are underway to better integrate information from third parties. TI has taken and continues to take reasonable steps to provide representative and accurate information but may not have conducted destructive testing or chemical analysis on incoming materials and chemicals. TI and TI suppliers consider certain information to be proprietary, and thus CAS numbers and other limited information may not be available for release.

In no event shall TI's liability arising out of such information exceed the total purchase price of the TI part(s) at issue in this document sold by TI to Customer on an annual basis.

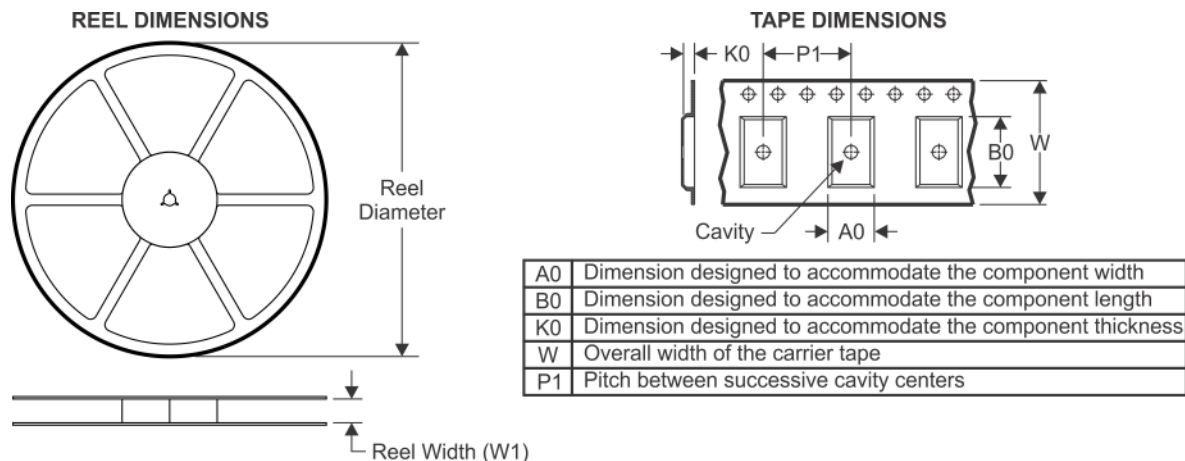
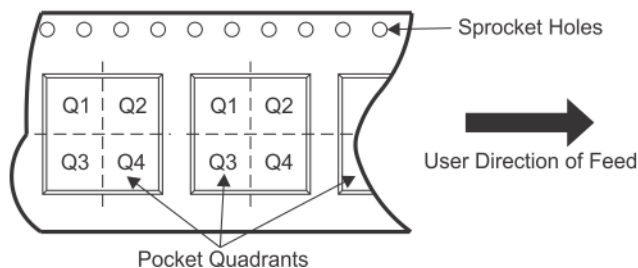
**TAPE AND REEL INFORMATION**

**QUADRANT ASSIGNMENTS FOR PIN 1 ORIENTATION IN TAPE**

\*All dimensions are nominal

Device	Package Type	Package Drawing	Pins	SPQ	Reel Diameter (mm)	Reel Width W1 (mm)	A0 (mm)	B0 (mm)	K0 (mm)	P1 (mm)	W (mm)	Pin1 Quadrant
74ACT16373DLR	SSOP	DL	48	1000	330.0	32.4	11.35	16.2	3.1	16.0	32.0	Q1



**TAPE AND REEL BOX DIMENSIONS**

\*All dimensions are nominal

Device	Package Type	Package Drawing	Pins	SPQ	Length (mm)	Width (mm)	Height (mm)
74ACT16373DLR	SSOP	DL	48	1000	367.0	367.0	55.0

**TUBE**



\*All dimensions are nominal

Device	Package Name	Package Type	Pins	SPQ	L (mm)	W (mm)	T (μm)	B (mm)
74ACT16373DL	DL	SSOP	48	25	473.7	14.24	5110	7.87

WD (R-GDFP-F\*\*)

CERAMIC DUAL FLATPACK

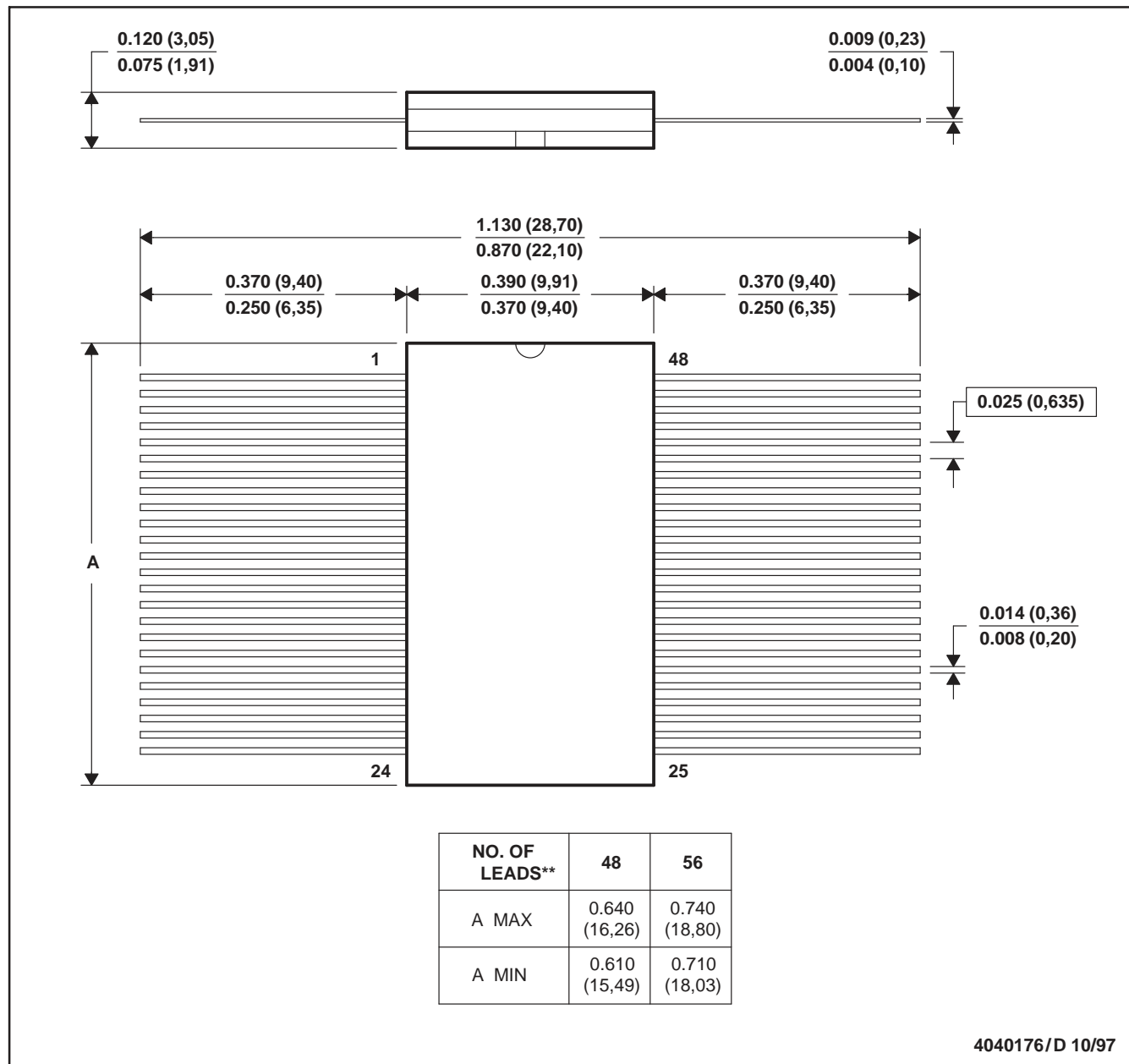
48 LEADS SHOWN



- NOTES: A. All linear dimensions are in inches (millimeters).  
 B. This drawing is subject to change without notice.  
 C. This package can be hermetically sealed with a ceramic lid using glass frit.  
 D. Index point is provided on cap for terminal identification only  
 E. Falls within MIL STD 1835: GDFP1-F48 and JEDEC MO-146AA  
 GDFP1-F56 and JEDEC MO-146AB

# MECHANICAL DATA

DL (R-PDSO-G48)

PLASTIC SMALL-OUTLINE PACKAGE

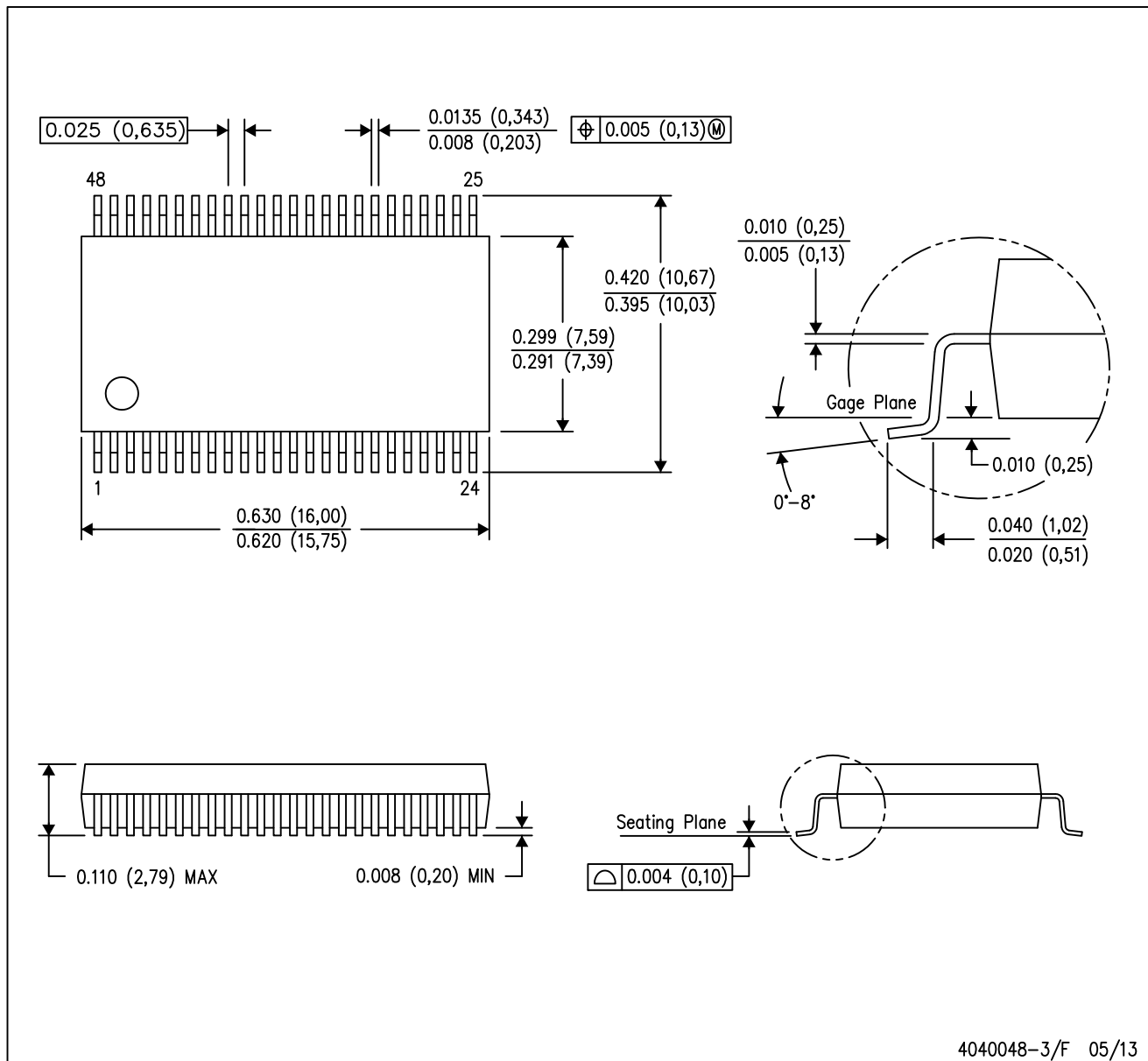

- NOTES:
- All linear dimensions are in inches (millimeters).
  - This drawing is subject to change without notice.
  - Body dimensions do not include mold flash or protrusion not to exceed 0.006 (0,15).
  - Falls within JEDEC MO-118

PowerPAD is a trademark of Texas Instruments.

## IMPORTANT NOTICE AND DISCLAIMER

TI PROVIDES TECHNICAL AND RELIABILITY DATA (INCLUDING DATA SHEETS), DESIGN RESOURCES (INCLUDING REFERENCE DESIGNS), APPLICATION OR OTHER DESIGN ADVICE, WEB TOOLS, SAFETY INFORMATION, AND OTHER RESOURCES "AS IS" AND WITH ALL FAULTS, AND DISCLAIMS ALL WARRANTIES, EXPRESS AND IMPLIED, INCLUDING WITHOUT LIMITATION ANY IMPLIED WARRANTIES OF MERCHANTABILITY, FITNESS FOR A PARTICULAR PURPOSE OR NON-INFRINGEMENT OF THIRD PARTY INTELLECTUAL PROPERTY RIGHTS.

These resources are intended for skilled developers designing with TI products. You are solely responsible for (1) selecting the appropriate TI products for your application, (2) designing, validating and testing your application, and (3) ensuring your application meets applicable standards, and any other safety, security, regulatory or other requirements.

These resources are subject to change without notice. TI grants you permission to use these resources only for development of an application that uses the TI products described in the resource. Other reproduction and display of these resources is prohibited. No license is granted to any other TI intellectual property right or to any third party intellectual property right. TI disclaims responsibility for, and you will fully indemnify TI and its representatives against, any claims, damages, costs, losses, and liabilities arising out of your use of these resources.

TI's products are provided subject to [TI's Terms of Sale](#) or other applicable terms available either on [ti.com](https://www.ti.com) or provided in conjunction with such TI products. TI's provision of these resources does not expand or otherwise alter TI's applicable warranties or warranty disclaimers for TI products.

TI objects to and rejects any additional or different terms you may have proposed.

Mailing Address: Texas Instruments, Post Office Box 655303, Dallas, Texas 75265  
Copyright © 2023, Texas Instruments Incorporated