

PLC-RSP- 12DC/21 - Relay Module



2967439

<https://www.phoenixcontact.com/us/products/2967439>

Please be informed that the data shown in this PDF document is generated from our online catalog. Please find the complete data in the user documentation. Our general terms of use for downloads are valid.



PLC-INTERFACE, consisting of PLC-BSP...../21 basic terminal block with spring-cage connection and plug-in miniature relay with power contact, for mounting on DIN rail NS 35/7,5, 1 changeover contact, input voltage 12 V DC

Your advantages

- Slim design
- Efficient connection to system cabling using V8 adapter
- RT III sealed relay
- Safe isolation according to DIN EN 50178 between coil and contact
- Integrated input circuit and interference suppression circuit
- Functional plug-in bridges

Commercial data

| | |
|--------------------------------------|--------------------------------|
| Item number | 2967439 |
| Packing unit | 1 pc |
| Minimum order quantity | 1 pc |
| Note | Made to order (non-returnable) |
| Sales key | C461 |
| Product key | CK622A |
| Catalog page | Page 322 (C-7-2013) |
| GTIN | 4017918165383 |
| Weight per piece (including packing) | 31.94 g |
| Weight per piece (excluding packing) | 30.1 g |
| Customs tariff number | 85364190 |
| Country of origin | DE |

PLC-RSP- 12DC/21 - Relay Module



2967439

<https://www.phoenixcontact.com/us/products/2967439>

Technical data

Product properties

| | |
|-------------------------|---------------------------|
| Product type | Relay Module |
| Product family | PLC-INTERFACE |
| Application | Universal |
| Operating mode | 100% operating factor |
| Mechanical service life | 2x 10 ⁷ cycles |

Insulation characteristics: Standards/regulations

| | |
|----------------------|-----|
| Overvoltage category | III |
| Pollution degree | 3 |

Electrical properties

| | |
|---|--|
| Maximum power dissipation for nominal condition | 0.18 W |
| Test voltage (Winding/contact) | 4 kV AC (50 Hz, 1 min., winding/contact) |

Input data

Coil side

| | |
|---|--|
| Nominal input voltage U _N | 12 V DC |
| Input voltage range | 9.7 V DC ... 16.8 V DC |
| Drive and function | monostable |
| Typical input current at U _N | 15.3 mA |
| Typical response time | 5 ms |
| Typical release time | 8 ms |
| Protective circuit | Reverse polarity protection; Polarity protection diode Freewheeling diode; Freewheeling diode |
| Operating voltage display | Yellow LED |

Output data

Switching

| | |
|---------------------------------------|---|
| Contact switching type | 1 changeover contact |
| Type of switch contact | Single contact |
| Contact material | AgSnO |
| Maximum switching voltage | 250 V AC/DC (The separating plate PLC-ATP should be installed for voltages larger than 250 V (L1, L2, L3) between identical terminal blocks in adjacent modules. Potential bridging is then carried out with FBST 8-PLC... or ...FBST 500...) |
| Minimum switching voltage | 5 V (at 100 mA) |
| Limiting continuous current | 6 A |
| Maximum inrush current | on request |
| Min. switching current | 10 mA (at 12 V) |
| Interrupting rating (ohmic load) max. | 140 W (at 24 V DC) 20 W (at 48 V DC) |

PLC-RSP- 12DC/21 - Relay Module



2967439

<https://www.phoenixcontact.com/us/products/2967439>

| | |
|----------------------|------------------------|
| Switching capacity | 18 W (at 60 V DC) |
| | 23 W (at 110 V DC) |
| | 40 W (at 220 V DC) |
| | 1500 VA (for 250 V AC) |
| | 2 A (at 24 V, DC13) |
| | 0.2 A (at 110 V, DC13) |
| | 0.1 A (at 220 V, DC13) |
| | 3 A (at 24 V, AC15) |
| 3 A (at 120 V, AC15) | |
| 3 A (at 230 V, AC15) | |

Connection data

Coil side

| | |
|----------------------------------|--|
| Connection method | Spring-cage connection |
| Stripping length | 8 mm |
| Conductor cross section rigid | 0.14 mm ² ... 2.5 mm ² |
| Conductor cross section flexible | 0.14 mm ² ... 2.5 mm ² |
| Conductor cross section AWG | 26 ... 14 |

Contact side

| | |
|----------------------------------|--|
| Connection method | Spring-cage connection |
| Stripping length | 8 mm |
| Conductor cross section rigid | 0.14 mm ² ... 2.5 mm ² |
| Conductor cross section flexible | 0.14 mm ² ... 2.5 mm ² |
| Conductor cross section AWG | 26 ... 14 |

Dimensions

| | |
|--------|--------|
| Width | 6.2 mm |
| Height | 80 mm |
| Depth | 94 mm |

Material specifications

| | |
|--|--------------|
| Flammability rating according to UL 94 | V0 (Housing) |
|--|--------------|

Environmental and real-life conditions

Ambient conditions

| | |
|---|-------------------|
| Degree of protection (Relay base) | IP20 (Relay base) |
| Ambient temperature (operation) | -40 °C ... 60 °C |
| Ambient temperature (storage/transport) | -40 °C ... 85 °C |

Standards and regulations

Standards/regulations

| | |
|-----------------------|-----------|
| Standards/regulations | IEC 60664 |
| | EN 50178 |

PLC-RSP- 12DC/21 - Relay Module



2967439

<https://www.phoenixcontact.com/us/products/2967439>

Mounting

| | |
|-----------------------|---------------------------|
| Mounting type | DIN rail mounting |
| Assembly instructions | in rows with zero spacing |
| Mounting position | any |

Drawings

Diagram

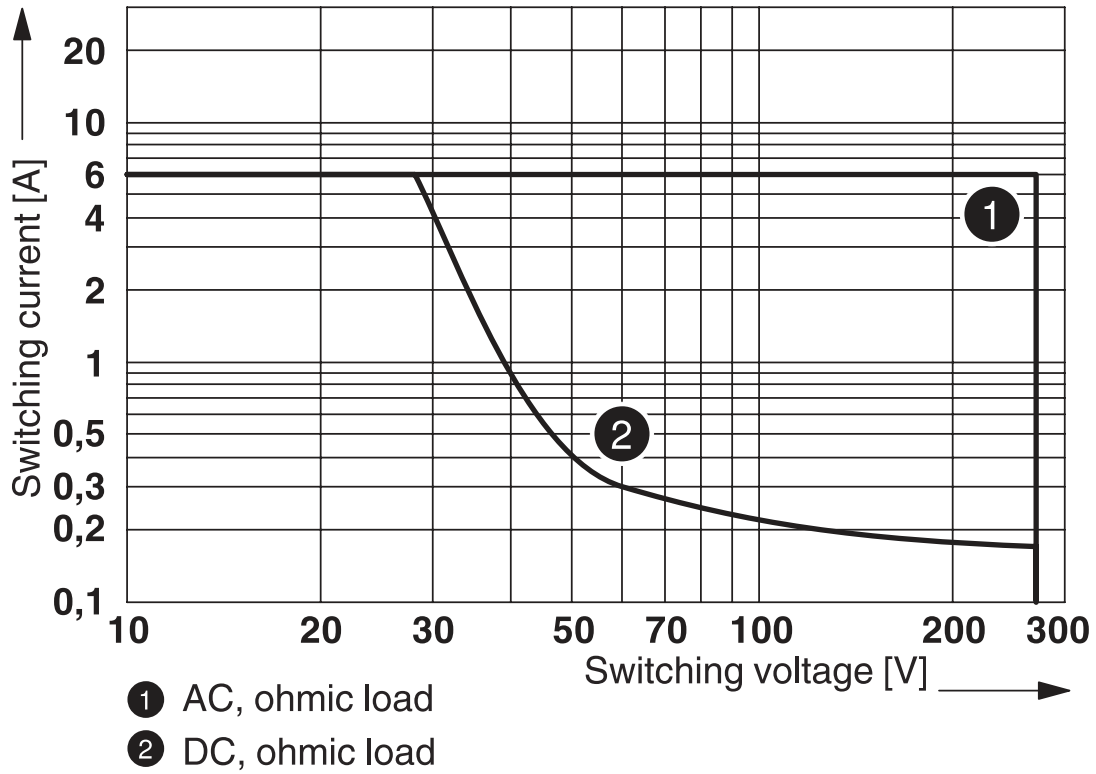

Interrupting rating

Diagram

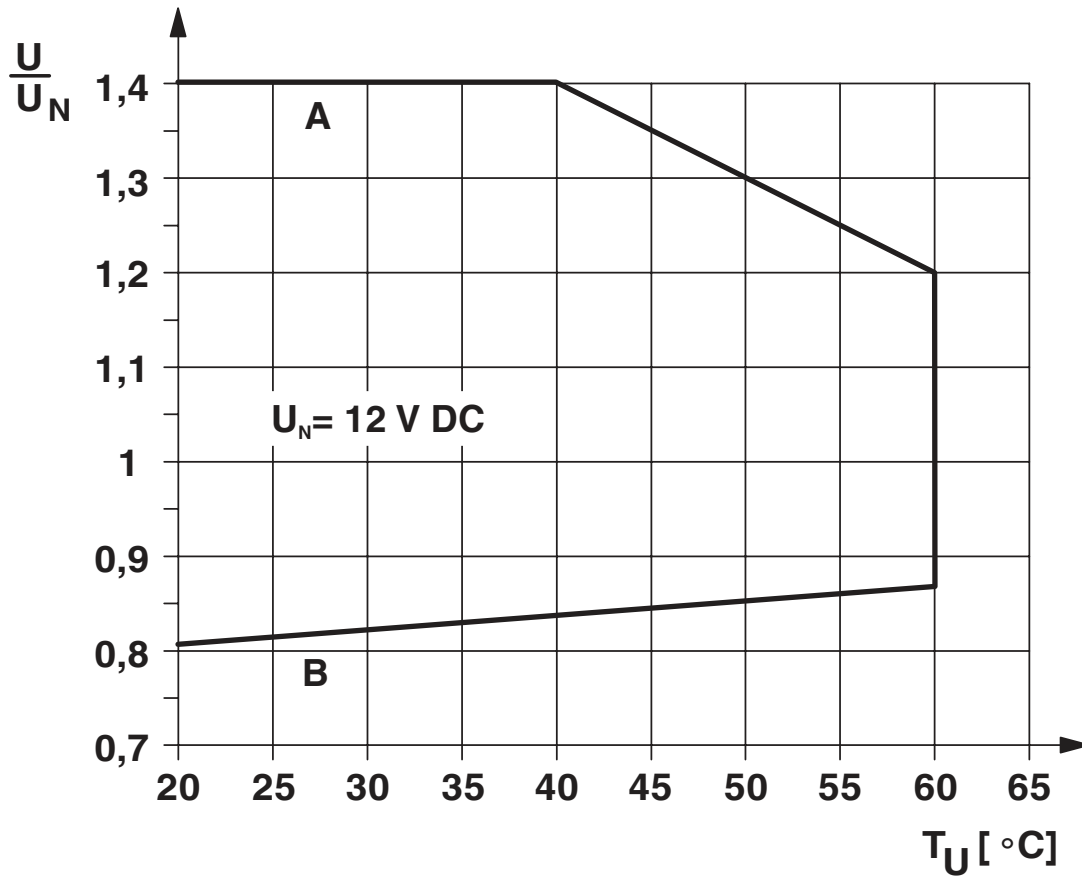

Curve A

Maximum permissible continuous voltage U_{max} with limiting continuous current on the contact side (see relevant technical data)

Curve B

Minimum permissible operate voltage U_{op} after pre-excitation (see relevant technical data)

PLC-RSP- 12DC/21 - Relay Module

2967439

<https://www.phoenixcontact.com/us/products/2967439>

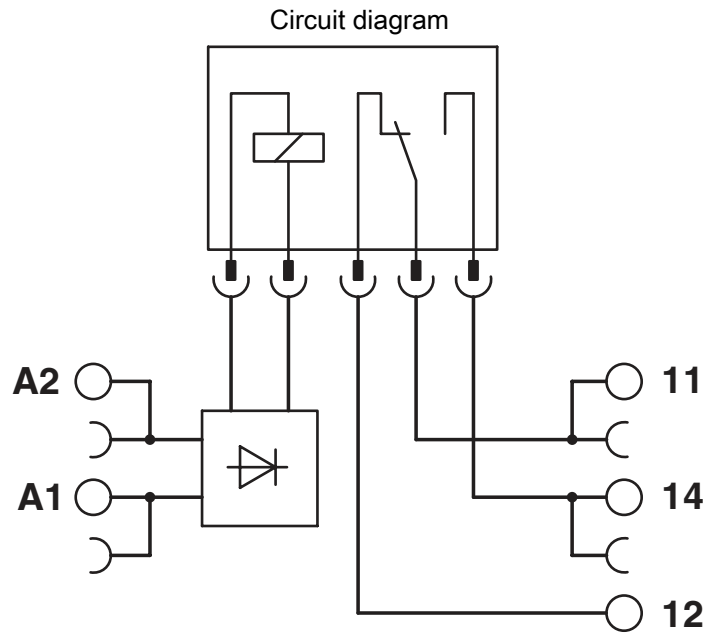

PLC-RSP- 12DC/21 - Relay Module



2967439

<https://www.phoenixcontact.com/us/products/2967439>

Classifications

ECLASS

ECLASS-11.0

27371601

ETIM

ETIM 7.0

EC001437

PLC-RSP- 12DC/21 - Relay Module



2967439

<https://www.phoenixcontact.com/us/products/2967439>

Environmental product compliance

| | |
|------------|--|
| China RoHS | Environmentally Friendly Use Period = 50 years For information on hazardous substances, refer to the manufacturer's declaration available under "Downloads" |
|------------|--|

PLC-RSP- 12DC/21 - Relay Module

2967439

<https://www.phoenixcontact.com/us/products/2967439>

Accessories

 Note: Applying some accessories below might limit this product.

FBST 500-PLC RD - Continuous plug-in bridge

2966786

<https://www.phoenixcontact.com/us/products/2966786>



Continuous plug-in bridge, length: 500 mm, color: red

 Max. current carrying capacity: 32 A

FBST 500-PLC BU - Continuous plug-in bridge

2966692

<https://www.phoenixcontact.com/us/products/2966692>



Continuous plug-in bridge, length: 500 mm, color: blue

 Max. current carrying capacity: 32 A

PLC-RSP- 12DC/21 - Relay Module

2967439

<https://www.phoenixcontact.com/us/products/2967439>



FBST 500-PLC GY - Continuous plug-in bridge

2966838

<https://www.phoenixcontact.com/us/products/2966838>



Continuous plug-in bridge, length: 500 mm, color: gray

 Max. current carrying capacity: 32 A

FBST 6-PLC RD - Single plug-in bridge

2966236

<https://www.phoenixcontact.com/us/products/2966236>



Single plug-in bridge, number of positions: 2, length: 6 mm, color: red

 Max. current carrying capacity: 6 A

PLC-RSP- 12DC/21 - Relay Module

2967439

<https://www.phoenixcontact.com/us/products/2967439>



FBST 6-PLC BU - Single plug-in bridge

2966812

<https://www.phoenixcontact.com/us/products/2966812>

Single plug-in bridge, number of positions: 2, length: 6 mm, color: blue



 Max. current carrying capacity: 6 A

FBST 6-PLC GY - Single plug-in bridge

2966825

<https://www.phoenixcontact.com/us/products/2966825>

Single plug-in bridge, number of positions: 2, length: 6 mm, color: gray



 Max. current carrying capacity: 6 A

PLC-RSP- 12DC/21 - Relay Module

2967439

<https://www.phoenixcontact.com/us/products/2967439>



FBST 8-PLC GY - Single plug-in bridge

2967688

<https://www.phoenixcontact.com/us/products/2967688>

Single plug-in bridge, number of positions: 2, length: 8 mm, color: gray



 Max. current carrying capacity: 6 A

NS 35/ 7,5 V2A UNPERF 2000MM - DIN rail, unperforated

0801377

<https://www.phoenixcontact.com/us/products/0801377>



DIN rail, unperforated, acc. to EN 60715, material: Stainless steel V2A, uncoated, Standard profile, color: silver, Pack of 25 (50 m)

PLC-RSP- 12DC/21 - Relay Module

2967439

<https://www.phoenixcontact.com/us/products/2967439>



NS 35/ 7,5 PERF 2000MM - DIN rail perforated

0801733

<https://www.phoenixcontact.com/us/products/0801733>



DIN rail perforated, acc. to EN 60715, material: Steel, galvanized, passivated with a thick layer, Standard profile, color: silver, Pack of 25 (50 m)

NS 35/ 7,5 CU UNPERF 2000MM-VPE 10 - DIN rail, unperforated

0801762

<https://www.phoenixcontact.com/us/products/0801762>



DIN rail, unperforated, acc. to EN 60715, material: Copper, uncoated, Standard profile, color: copper-colored, Pack of 10 (20 m)

PLC-RSP- 12DC/21 - Relay Module

2967439

<https://www.phoenixcontact.com/us/products/2967439>



NS 35/15 UNPERF 2000MM - DIN rail, unperforated

1201714

<https://www.phoenixcontact.com/us/products/1201714>



DIN rail, unperforated, similar to EN 60715, material: Steel, galvanized, passivated with a thick layer, Standard profile, color: silver, Pack of 25 (50 m)

NS 35/15 CU UNPERF 2000MM-VPE 10 - DIN rail, unperforated

1201895

<https://www.phoenixcontact.com/us/products/1201895>



DIN rail, unperforated, similar to EN 60715, material: Copper, uncoated, Standard profile, color: copper-colored, Pack of 10 (20 m)

PLC-RSP- 12DC/21 - Relay Module

2967439

<https://www.phoenixcontact.com/us/products/2967439>



NS 35/15-2,3 UNPERF 2000MM-VPE 10 - DIN rail, unperforated

1201798

<https://www.phoenixcontact.com/us/products/1201798>



DIN rail, unperforated, acc. to EN 60715, material: Steel, galvanized, passivated with a thick layer, Standard profile 2.3 mm, color: silver, Pack of 10 (20 m)

NS 35/15 AL UNPERF 2000MM - DIN rail, unperforated

1201756

<https://www.phoenixcontact.com/us/products/1201756>



DIN rail, unperforated, similar to EN 60715, material: Aluminum, uncoated, Standard profile, color: silver

PLC-RSP- 12DC/21 - Relay Module

2967439

<https://www.phoenixcontact.com/us/products/2967439>



NS 35/15 PERF 2000MM - DIN rail perforated

1201730

<https://www.phoenixcontact.com/us/products/1201730>



DIN rail perforated, similar to EN 60715, material: Steel, galvanized, passivated with a thick layer, Standard profile, color: silver, Pack of 25 (50 m)

NS 35/ 7,5 UNPERF 2000MM - DIN rail, unperforated

0801681

<https://www.phoenixcontact.com/us/products/0801681>



DIN rail, unperforated, acc. to EN 60715, material: Steel, galvanized, passivated with a thick layer, Standard profile, color: silver, Pack of 25 (50 m)

PLC-RSP- 12DC/21 - Relay Module

2967439

<https://www.phoenixcontact.com/us/products/2967439>



PLC-ESK GY - Power terminal block

2966508

<https://www.phoenixcontact.com/us/products/2966508>



Power terminal block, for the input of up to four potentials, for mounting on NS 35/7.5

PLC-ATP BK - Separating plate

2966841

<https://www.phoenixcontact.com/us/products/2966841>



Separating plate, 2 mm thick, required at the start and end of a PLC terminal strip. Furthermore, it is used for: visual separation of groups, safe isolation of different voltages of neighboring PLC relays in acc. with DIN VDE 0106-101, isolation

PLC-RSP- 12DC/21 - Relay Module

2967439

<https://www.phoenixcontact.com/us/products/2967439>



SZF 1-0,6X3,5 - Screwdriver

1204517

<https://www.phoenixcontact.com/us/products/1204517>



Actuation tool, for ST terminal blocks, also suitable for use as a bladed screwdriver, size: 0.6 x 3.5 x 100 mm, 2-component grip, with non-slip grip

ZB 6:UNBEDRUCKT - Zack marker strip

1051003

<https://www.phoenixcontact.com/us/products/1051003>



Zack marker strip, Strip, white, unlabeled, can be labeled with: PLOTMARK, CMS-P1-PLOTTER, mounting type: snapped, for terminal block width: 6.2 mm, lettering field size: 6.15 x 10.5 mm, Number of individual labels: 10

PLC-RSP- 12DC/21 - Relay Module

2967439

<https://www.phoenixcontact.com/us/products/2967439>



ZB 6,LGS:FORTL.ZAHLEN - Zack marker strip

1051016

<https://www.phoenixcontact.com/us/products/1051016>



Zack marker strip, Strip, white, labeled, can be labeled with: CMS-P1-PLOTTER, printed horizontally: consecutive numbers 1 ... 10, 11 ... 20, etc. up to 491 ... 500, mounting type: snapped, for terminal block width: 6.2 mm, lettering field size: 6.15 x 10.5 mm, Number of individual labels: 10

ZB 6/WH-100:UNBEDRUCKT - Zack marker strip

5060935

<https://www.phoenixcontact.com/us/products/5060935>



Zack marker strip, Strip, white, unlabeled, can be labeled with: PLOTMARK, CMS-P1-PLOTTER, mounting type: snapped, for terminal block width: 6.2 mm, lettering field size: 6.15 x 10.5 mm, Number of individual labels: 1000

PLC-RSP- 12DC/21 - Relay Module



2967439

<https://www.phoenixcontact.com/us/products/2967439>

UC-TM 6 - Marker for terminal blocks

0818085

<https://www.phoenixcontact.com/us/products/0818085>



Marker for terminal blocks, Sheet, white, unlabeled, can be labeled with: BLUEMARK ID COLOR, BLUEMARK ID, BLUEMARK CLED, PLOTMARK, CMS-P1-PLOTTER, mounting type: snapped, for terminal block width: 6.2 mm, lettering field size: 5.6 x 10.5 mm, Number of individual labels: 80

UCT-TM 6 - Marker for terminal blocks

0828736

<https://www.phoenixcontact.com/us/products/0828736>



Marker for terminal blocks, Sheet, white, unlabeled, can be labeled with: TOPMARK NEO, TOPMARK LASER, BLUEMARK ID COLOR, BLUEMARK ID, BLUEMARK CLED, THERMOMARK PRIME, THERMOMARK CARD 2.0, THERMOMARK CARD, mounting type: snapped, for terminal block width: 6.2 mm, lettering field size: 5.6 x 10.5 mm, Number of individual labels: 60

PLC-RSP- 12DC/21 - Relay Module

2967439

<https://www.phoenixcontact.com/us/products/2967439>



REL-MR- 12DC/21 - Single relay

2961150

<https://www.phoenixcontact.com/us/products/2961150>

Plug-in miniature power relay, with power contact, 1 changeover contact, input voltage 12 V DC

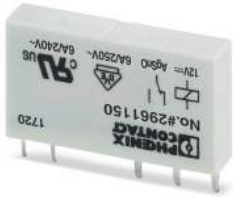

Phoenix Contact 2023 © - all rights reserved

<https://www.phoenixcontact.com>

Phoenix Contact USA
586 Fulling Mill Road
Middletown, PA 17057, United States
(+717) 944-1300
info@phoenixcon.com