

### General information

Part number	S20F1C-P03MJG0-400S
Termination	solder
Size	0
Locking principle	push
Coding	1_halfshell
Cable Diameter	cable_mini_40
Cable outlet	bend_relief

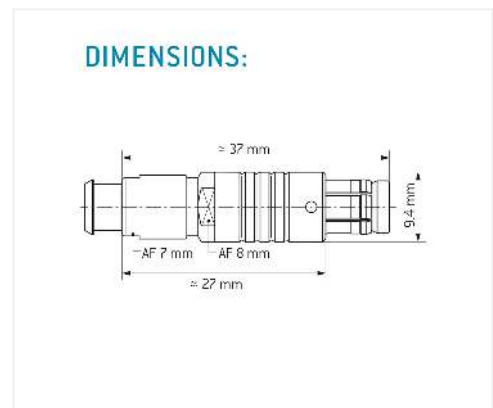
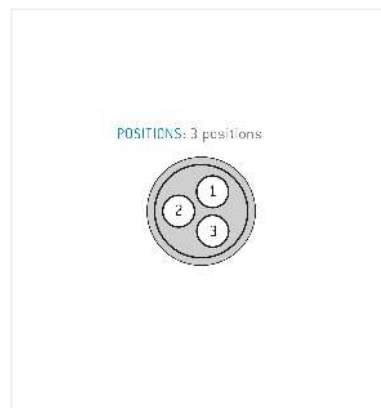

### Contact insert description

Number of contacts	3
Contact type	pins
Contact diameter	09mm
Insulator material	peek
Wire cross section	22_awg
Termination	solder
Termination diameter	085mm

reverse\_gender\_on\_request

### Technical information

Max. creepage and air clearance distance	06_mm	09_mm
Nominal current single contact	075_a	iec_60512_5_2
Nominal current insert	7,5 A	vde_0298_4
Test voltage	12_kv_ac	sae_13441

safety\_text

## Mechanical and environmental data

Degree of protection*	ip50
-----------------------	------

Operating temperature	40_120_c
-----------------------	----------

Mating cycles	5000
---------------	------

mated\_unmated

## Material and surface treatments

Housing	m_chrome
---------	----------

Contact	cu_alloy_gold
---------	---------------

safety\_text\_2

ul\_text

illustrative\_text