

Xinger®

Delay Line

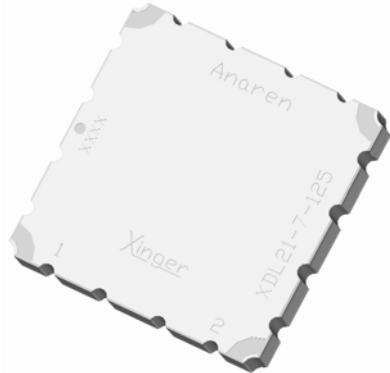

DESCRIPTION

The XDL21-7-125 is a surface mount delay line that uses a slow wave coupling structure that maximizes the amount of delay per unit area over other distributed delay structures. The XDL21-7-125 can be used in amplifier linearization applications from 2110 – 2170MHz. The XDL21-7-125 is ideal for use in the main loop of feed forward and in pre-distortion amplifiers. The Xinger® delay lines are a low cost, high quality alternative to the traditional coaxial and filter solutions presently available. Parts have been subjected to rigorous qualification testing and units are 100% tested.

ELECTRICAL SPECIFICATIONS

Features:

- Production Friendly
- Consistent Delay
- Stable Over Temperature
- Surface Mountable
- Available in Tape & Reel
- Non-Lead Solder Paste Compatible
- 100% Tested
- Lead Free

Frequency (MHz.)	2110 – 2170 UMTS Band
Mean Delay (nS)	12.5±0.25
Deviation from Linear Phase (Degrees Max)	±1.0
Amplitude Flatness (dB p-p)	0.15
Return Loss (dB min)	20
Insertion Loss (dB/nS)	0.55
Insertion Phase (Degrees)	110±30
Power Handling (Watts)	1
θJC (°C/watts)	5
Operating Temp. (°C)	-55 to +85

Specification based on performance of unit properly installed on microstrip printed circuit boards with 50 Ω nominal impedance. Specifications subject to change without notice.

Mechanical Drawing

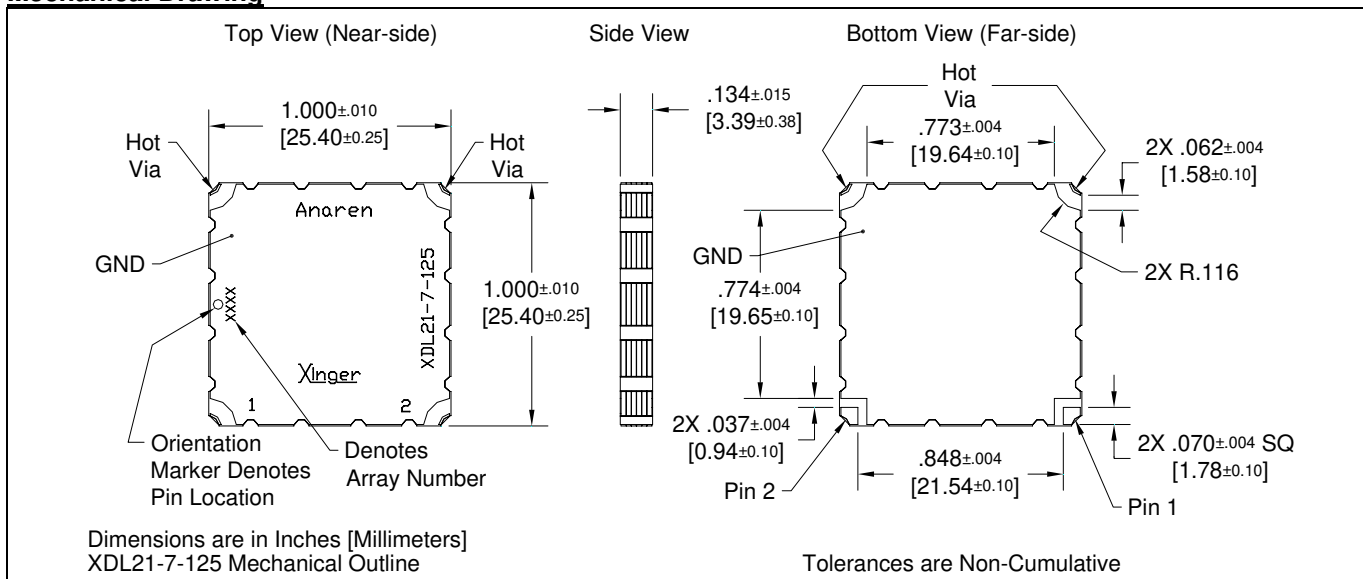

TYPICAL PERFORMANCE: 500 MHz. To 2500 MHz.

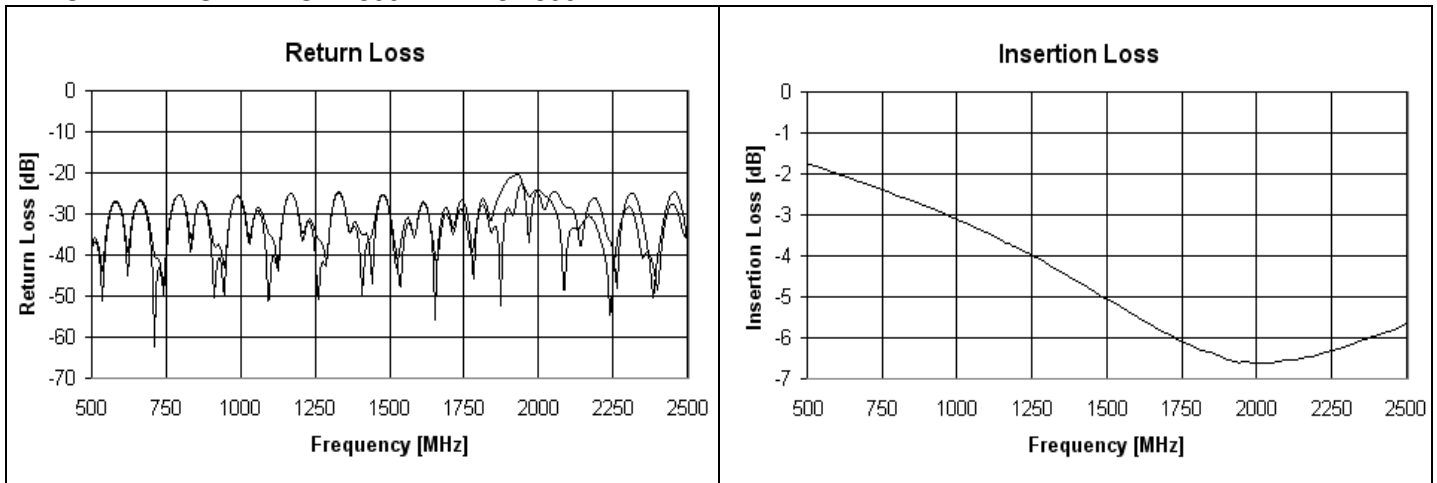

AVERAGE DELAY

The average delay is defined as the group delay of the input signal through the delay line. The lot-to-lot variation is reflected in the plus/minus tolerance given in specifications.

Refer to Anaren Application Note AAN-232 for further information on Xinger delay lines.

MOUNTING GUIDELINES:

To insure proper electrical and thermal performance there must be a ground plane with 100% solder connection underneath the part

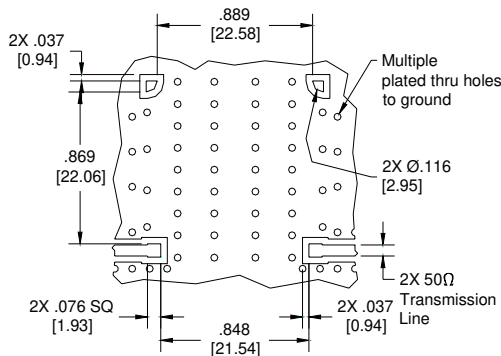
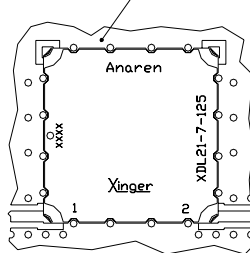

Dimensions are in Inches [Millimeters]
XDL21-7-125 Mounting Footprint

In order for Xinger surface mount delay lines to work optimally, there must be 50Ω transmission lines leading to and from all of the RF ports. Also, there must be a very good ground plane under the part with a number of plated thru holes to ensure proper electrical performance. If any of these conditions are not satisfied, insertion loss, average delay and VSWR may not meet published specifications.

When a surface mount delay line is mounted to a printed circuit board (PCB), the primary concerns are; insuring the RF pads of the device are in contact with the circuit trace of the PCB and the ground plane of neither the component nor the PCB are in contact with the RF signal. An example of how the PCB footprint could look is shown below. In particular designs, the 50Ω lines need to be adjusted to the unique dielectric coefficients and thicknesses as well as varying pick and place equipment tolerances.

USA/Canada: (315) 432-8909
Toll Free: (800) 544-2414
Europe: +44 2392-232392

Available on Tape and Reel For Pick and Place Manufacturing.



Carrier Tape

Parts are oriented in embossed tape as shown below

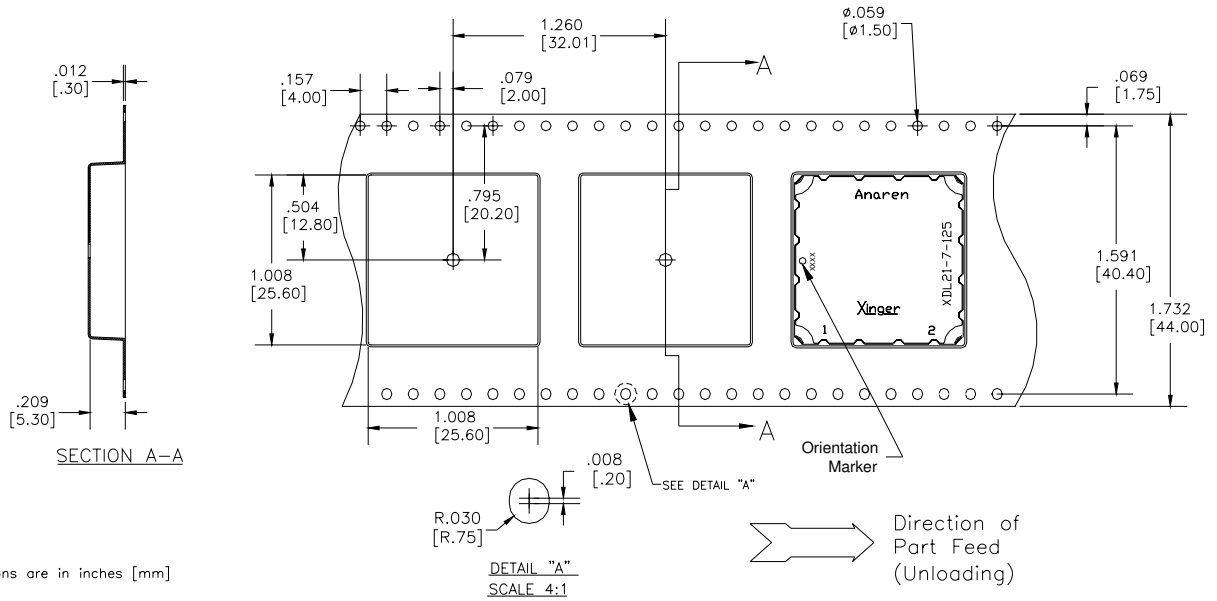

Reel

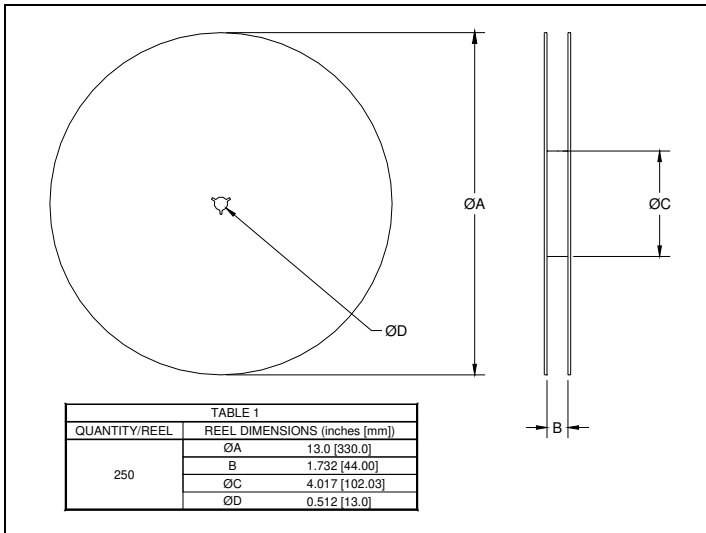

- Parts are available in both reel and tube
- Quantity of 19 parts available per tube

