

796466-1 ✓ ACTIVE

AMP | AMP CPC

TE Internal #: 796466-1

Circular Power Connectors, Housing, 600 VDC, Wire-to-Wire, 16 Position, Sealable, Wire & Cable, Receptacle, Pin, Power & Signal, Black, AMP CPC

[View on TE.com >](#)



Connectors > Power Connectors > Circular Power > Circular Power Connectors > Sealed Two-Piece Connector, CPC Series 6



Connector Product Type: **Housing**

Operating Voltage: **600 VDC**

Connector System: **Wire-to-Wire**

Number of Positions: **16**

Sealable: **Yes**

[All Sealed Two-Piece Connector, CPC Series 6 \(11\)](#)

Features

Product Type Features

Connector Seal & Plug Type	Peripheral, Wire Entry Seal
Connector Product Type	Housing
Connector System	Wire-to-Wire
Sealable	Yes
Connector & Contact Terminates To	Wire & Cable
Connector & Housing Type	Receptacle
Circular Connector Shell Type	All Plastic

Configuration Features

Reverse Numbering	With
Number of Positions	16
Number of Power Positions	4
Number of Signal Positions	12



Electrical Characteristics

Operating Voltage	600 VAC
-------------------	---------

Contact Features

Reverse Gender	No
Contact Type	Pin
Contact Protection	With

Mechanical Attachment

Mating Alignment Type	Keyed
Mating Alignment	With
Panel Mount Feature Type	Flange with Mounting Holes
Mating Retention Type	Threaded Coupling
Thread Size	1-3/8 - 18 UNEF-2A
Polarization Code	A
Connector Mounting Type	Panel Mount
Mating Retention	With
Panel Mount Feature	With

Housing Features

Body Orientation	Straight
Housing Color	Black
Housing Material	Nylon
Circular Connector Shell Size	23

Usage Conditions

Operating Temperature Range	-55 – 105 °C[-67 – 221 °F]
Fluid Resistance	Immersion

Operation/Application

Circuit Application	Power & Signal
Shielded	No

Industry Standards

CSA Rating	Not Certified
UL Flammability Rating	UL 94V-0

Packaging Features

Packaging Quantity	20
--------------------	----



Packaging Method

Package

Product Compliance

[For compliance documentation, visit the product page on TE.com>](#)

EU RoHS Directive 2011/65/EU	Compliant
EU ELV Directive 2000/53/EC	Compliant
China RoHS 2 Directive MIIT Order No 32, 2016	No Restricted Materials Above Threshold
EU REACH Regulation (EC) No. 1907/2006	Current ECHA Candidate List: JUNE 2023 (235) Candidate List Declared Against: JAN 2023 (233) Does not contain REACH SVHC
Halogen Content	BFR/CFR/PVC Free, but Br/Cl >900 ppm in other sources.
Solder Process Capability	Not applicable for solder process capability

Product Compliance Disclaimer

This information is provided based on reasonable inquiry of our suppliers and represents our current actual knowledge based on the information they provided. This information is subject to change. The part numbers that TE has identified as EU RoHS compliant have a maximum concentration of 0.1% by weight in homogenous materials for lead, hexavalent chromium, mercury, PBB, PBDE, DBP, BBP, DEHP, DIBP, and 0.01% for cadmium, or qualify for an exemption to these limits as defined in the Annexes of Directive 2011/65/EU (RoHS2). Finished electrical and electronic equipment products will be CE marked as required by Directive 2011/65/EU. Components may not be CE marked. Additionally, the part numbers that TE has identified as EU ELV compliant have a maximum concentration of 0.1% by weight in homogenous materials for lead, hexavalent chromium, and mercury, and 0.01% for cadmium, or qualify for an exemption to these limits as defined in the Annexes of Directive 2000/53/EC (ELV). Regarding the REACH Regulation, the information TE provides on SVHC in articles for this part number is based on the latest European Chemicals Agency (ECHA) 'Guidance on requirements for substances in articles' posted at this URL: <https://echa.europa.eu/guidance-documents/guidance-on-reach>

Compatible Parts

 <p>TE Part # 796203-1 SLD CPC PLUG ASSY,23-16,STD SX</p>	 <p>TE Part # 6-2407269-3 CAP, CPC, SIZE 23 RECP, RED</p>	 <p>TE Part # 6-2407269-2 CAP, CPC, SIZE 23 RECP, BLACK</p>	 <p>TE Part # 6-2407269-1 CAP, CPC, SIZE 23 RECP, ORANGE</p>
--	--	--	---



Also in the Series | AMP CPC

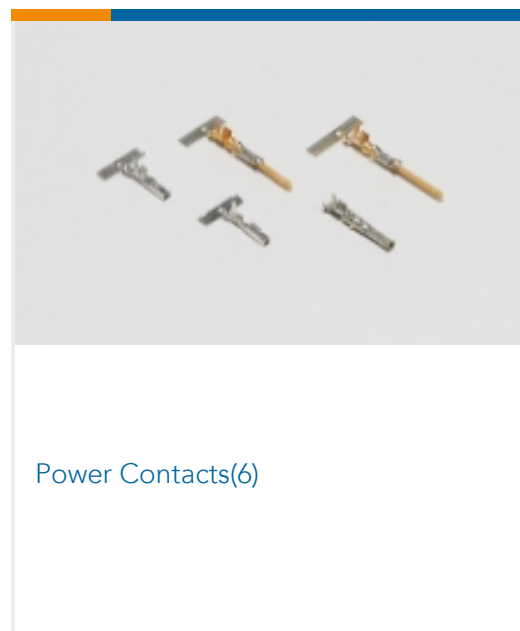
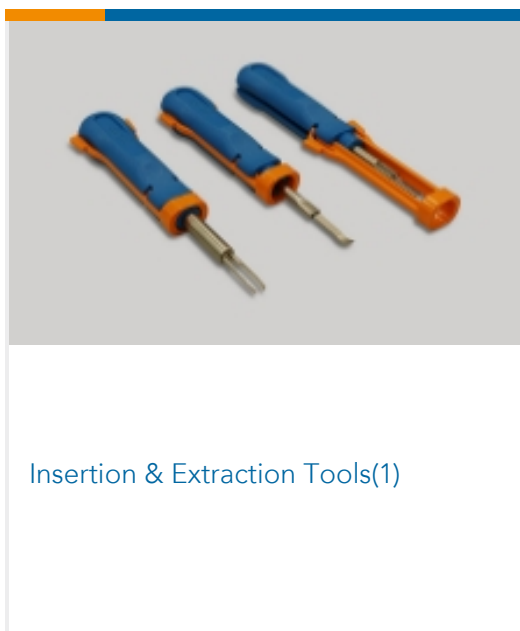
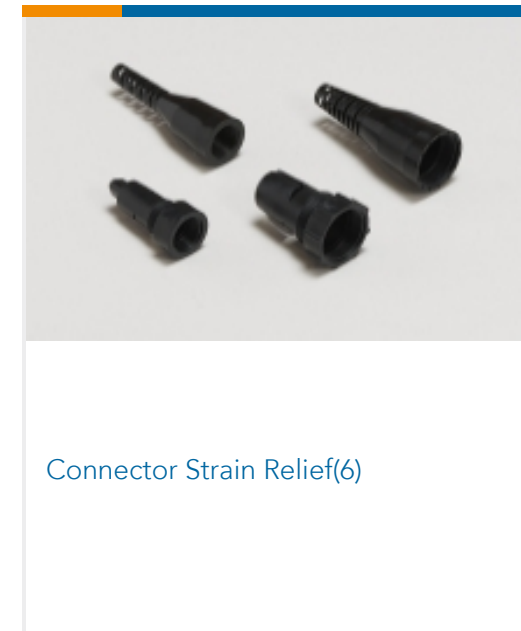
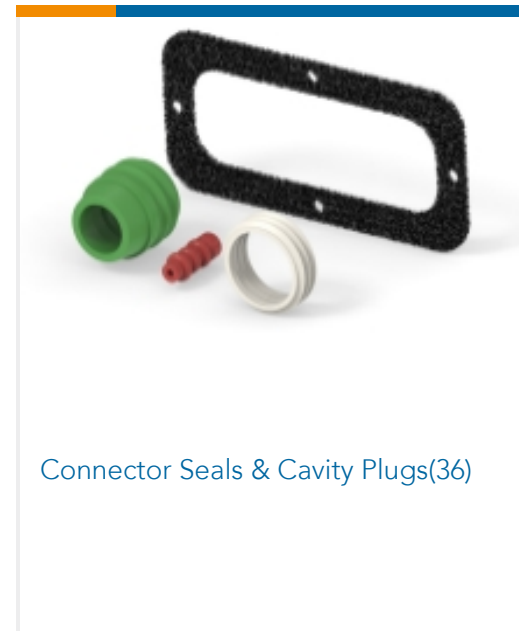
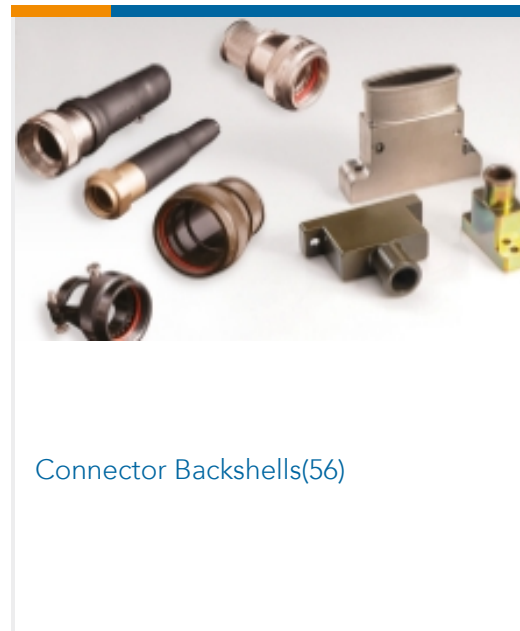
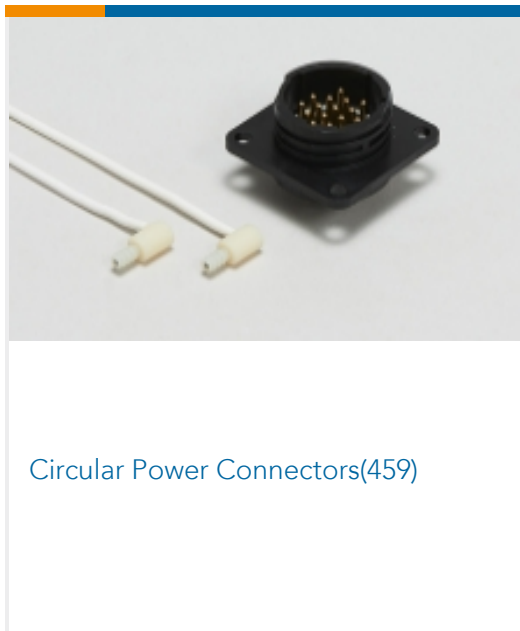
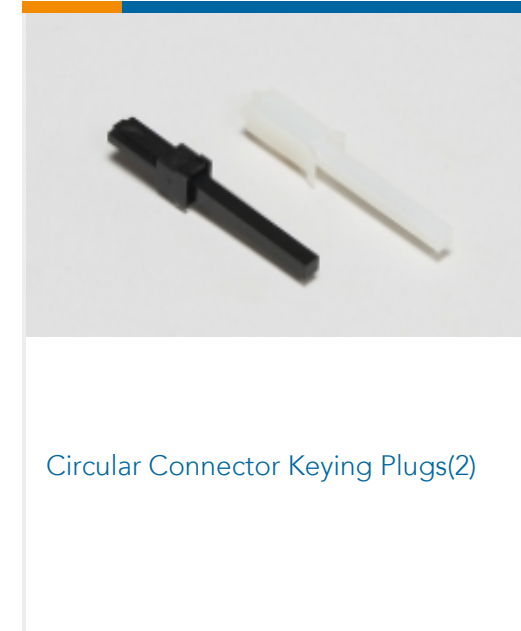
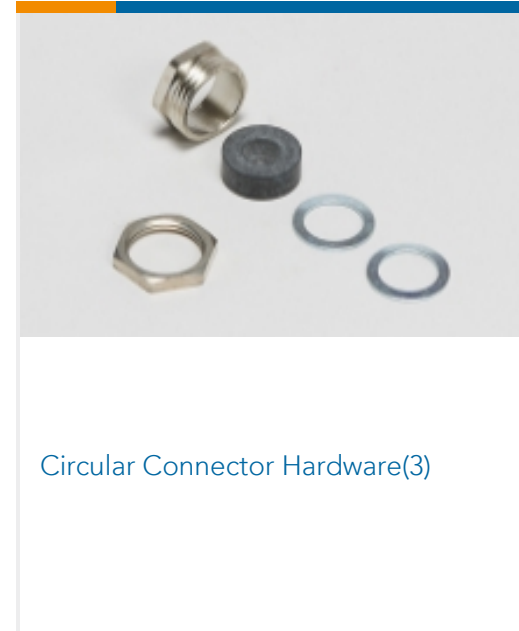
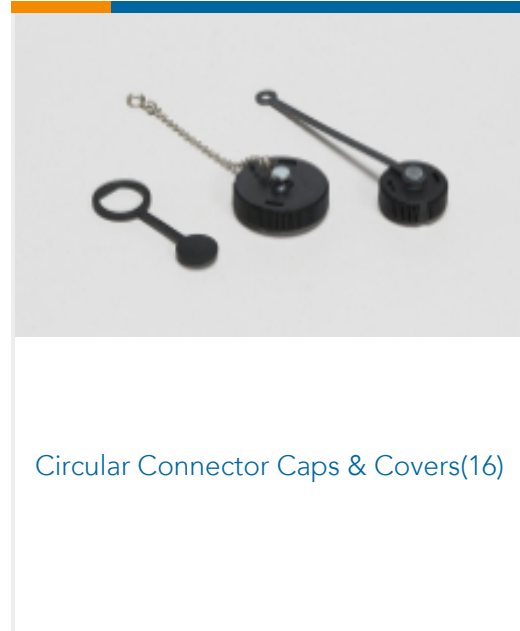
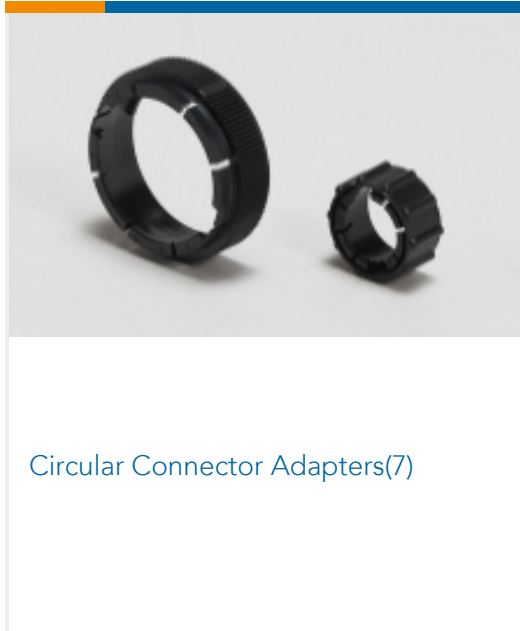

Customers Also Bought



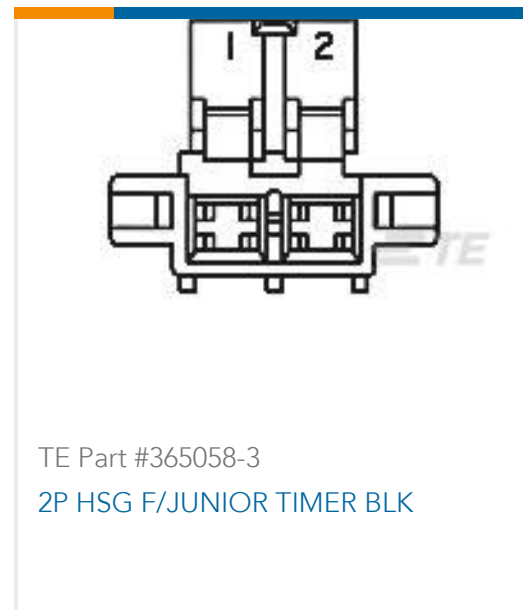

Documents

CAD Files

3D PDF

3D

Customer View Model

[ENG_CVM_CVM_796466-1_H.2d_dxf.zip](#)

English

Customer View Model

[ENG_CVM_CVM_796466-1_H.3d_igs.zip](#)

English

Customer View Model

[ENG_CVM_CVM_796466-1_H.3d_stp.zip](#)

English

3D PDF

English

Customer View Model

[ENG_CVM_796466-1_B.2d_dxf.zip](#)

English

Customer View Model

[ENG_CVM_796466-1_B.3d_igs.zip](#)

English

Customer View Model

[ENG_CVM_796466-1_B.3d_stp.zip](#)

English

By downloading the CAD file I accept and agree to the [Terms and Conditions](#) of use.

Datasheets & Catalog Pages

[AMP Circular Connectors for Commercial Signal & Power Applications](#)



English

[Product Specifications](#)

[Product Specification](#)

English