

LTM4670 Low V_{IN} , Quad μ Module Regulator with Configurable 10A Output Array Step-Down Regulator

DESCRIPTION

Demonstration circuit 2891A features the **LTM®4670EY**, a high efficiency, quad 10A step-down power μ Module® regulator. The input voltage range is from 2.25V to 5.5V. The output voltage range is 0.5V to V_{IN} . Derating is necessary for certain V_{IN} , V_{OUT} , frequency and thermal conditions. The DC2891A offers the SSTT pin allowing the user to program output tracking, soft-start period and die temperature monitoring.

The MODE/SYNC pin either synchronizes the switching frequency to an external clock, is a clock output, or sets the PWM mode. The PWM modes of operation are forced continues mode for low noise or pulse-skipping mode for high efficiency at light load. The LTM4670 defaults to forced continues mode in regulation and during synchronization. The LTM4670 operates in pulse-skipping mode when both the FREQ and MODE/SYNC pins are connected to V_{IN} .

DC2891A has optional jumper resistors to parallel multiple LTM4670 channels. For paralleled channels, one channel can be set as master, and the rest can be set as slaves. The phase shift of a slave channel relative to the master channel can be programmed with a resistor divider on the FREQ pin.

For DC2891A, four channels of LTM4670 are working separately and all set as master. A multiphase oscillator LTC6902 is used to set 90-degree phase shift between adjacent phases and reduce the amount of ripple current in both the input and output capacitors.

The LTM4670 data sheet must be read in conjunction with this demo manual prior to working on or modifying demo circuit DC2891A.

[Design files for this circuit board are available.](#)

All registered trademarks and trademarks are the property of their respective owners.

BOARD PHOTO

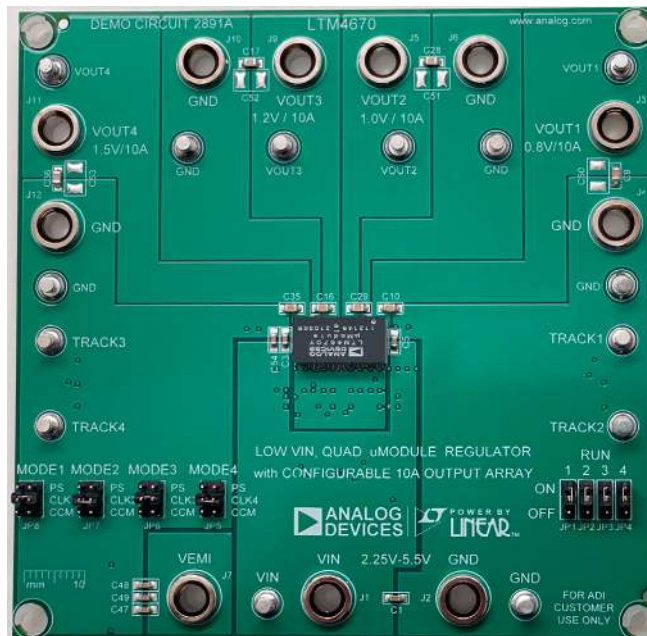

PERFORMANCE SUMMARY Specifications are at $T_A = 25^\circ\text{C}$

PARAMETER	CONDITIONS	MIN	TYP	MAX	UNITS
Input Voltage Range		2.25		5.5	V
Output Voltages	0.8V, 1.0V, 1.2V, 1.5V.			± 1.5	%
Maximum Continuous Output Current	Derating is Necessary for Certain Operating Conditions. See Data Sheet for Details.	10ADC for Each Channel			ADC
Operating Frequency		2			MHz
Efficiency of Channel 1	$V_{IN} = 3.3\text{V}$, $V_{OUT1} = 0.8\text{V}$, $I_{OUT1} = 10\text{A}$	83.03, See Figure 2			%
Efficiency of Channel 2	$V_{IN} = 3.3\text{V}$, $V_{OUT2} = 1.0\text{V}$, $I_{OUT2} = 10\text{A}$	84.35, See Figure 3			%
Efficiency of Channel 3	$V_{IN} = 3.3\text{V}$, $V_{OUT3} = 1.2\text{V}$, $I_{OUT3} = 10\text{A}$	86.32, See Figure 4			%
Efficiency of Channel 4	$V_{IN} = 3.3\text{V}$, $V_{OUT4} = 1.5\text{V}$, $I_{OUT4} = 10\text{A}$	88.09, See Figure 5			%

QUICK START PROCEDURE

Demonstration circuit DC2891A is an easy way to evaluate the performance of the LTM4670EY. Please refer to Figure 1 for proper measurement equipment setup and follow the procedure below.

- Place jumpers in the following positions for a typical application:

RUN1	RUN2	RUN3	RUN4
ON	ON	ON	ON

MODE1	MODE2	MODE3	MODE4
CLK1	CLK2	CLK3	CLK4

- With power off, connect the input power supply, loads and meters as shown in Figure 1. Preset the load to 0A and V_{IN} supply to 3.3V.
- Turn on the power supply at the input. The output voltage of channel 1 should be $0.8\text{V} \pm 1.5\%$ (0.788V to 0.812V). The output voltage of channel 2 should be $1.0\text{V} \pm 1.5\%$ (0.985V to 1.015V). The output voltage of channel 3 should be $1.2\text{V} \pm 1.5\%$ (1.182V to 1.218V). The output voltage of channel 4 should be $1.5\text{V} \pm 1.5\%$ (1.478V to 1.522V).
- Vary the input voltage from 2.25V to 5.5V and adjust the load current of each channel from 0A–10A. Observe the output voltage regulation, ripple voltage, efficiency, and other parameters.

- (Optional) To set one channel of LTM4670 to pulse-skipping mode, not only the MODE pin jumper of that channel needs to be put on “PS”, but also corresponding FREQ pin needs to be connected to V_{IN} . See Table 1.

Table 1.

FREQ PIN CONNECTION	MODE/ SYNC PIN CONNECTION	MODE OF OPERATION	SWITCHING FREQUENCY
V_{IN}	Clock Input	Forced Continuous	External Clock
V_{IN}	AGND	Forced Continuous	2MHz Default
V_{IN}	V_{IN}	Pulse-Skipping	2MHz Default
Resistor to AGND	Clock Output	Forced Continuous	FREQ Programmed

- (Optional) To parallel the four channels of LTM4670 to create one single output, R32 to R46, R48 to R50 need to be changed to 0Ω . Also, R61, R62 and R63 need to be removed from the board. When working in parallel configuration, one channel can be set as master and the others can be set as slaves. The phase shift of a slave channel relative to the master channel can be programmed with a resistor divider on the FREQ pin. Please refer to the LTM4670 data sheet for details.

QUICK START PROCEDURE

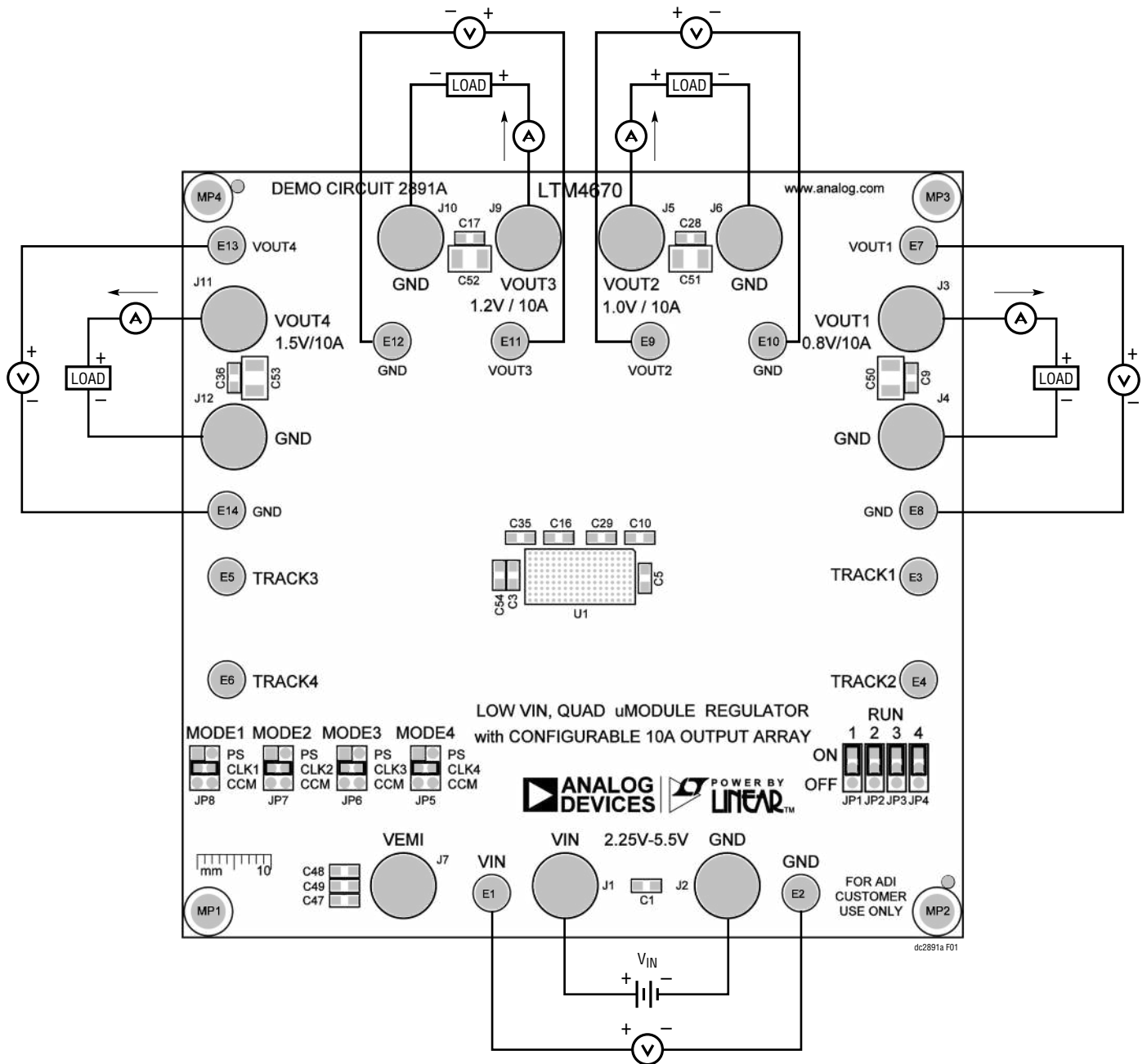

Figure 1. Measurement Setup of DC2891A

QUICK START PROCEDURE

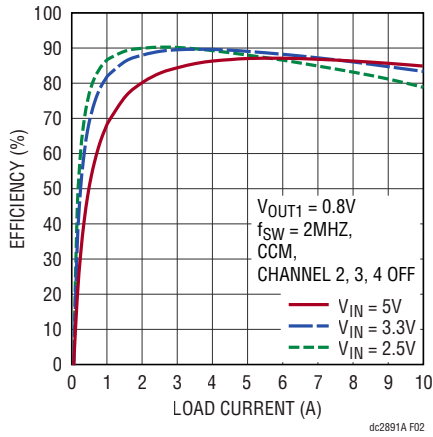

Figure 2. Measured Efficiency on Channel 1

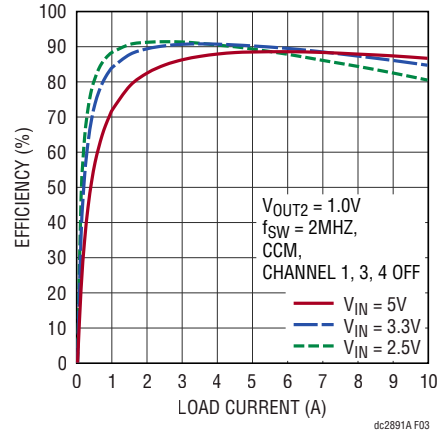

Figure 3. Measured Efficiency on Channel 2

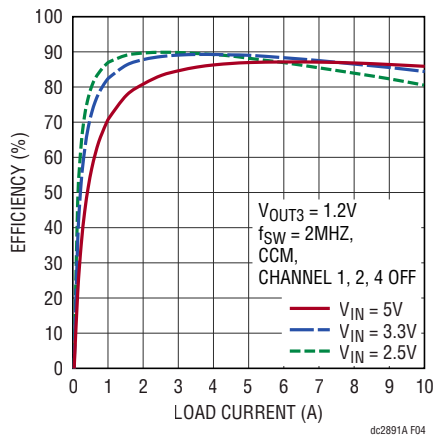

Figure 4. Measured Efficiency on Channel 3

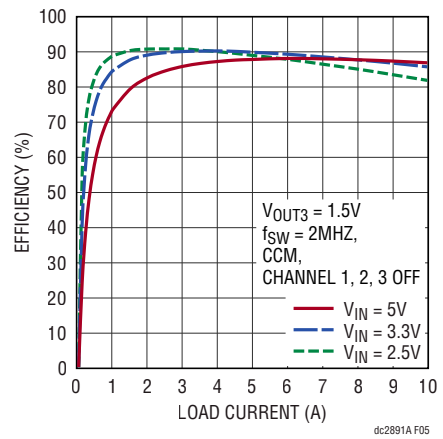

Figure 5. Measured Efficiency on Channel 4

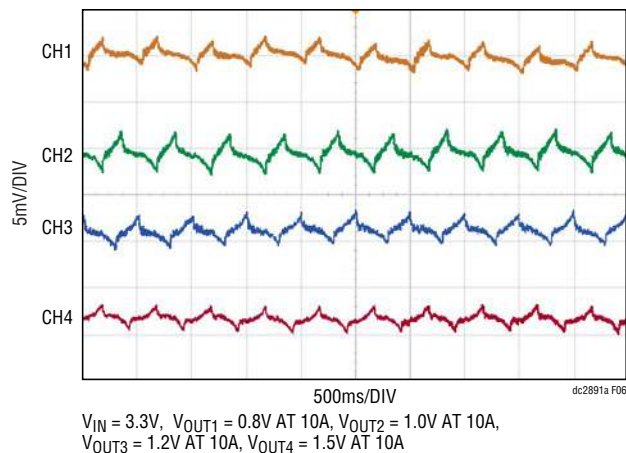

Figure 6. Output Voltage Ripples of Four Channels

QUICK START PROCEDURE

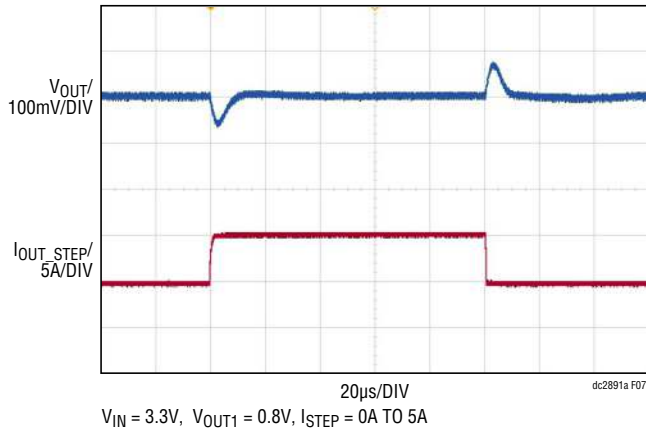

Figure 7. Measured Channel 1 Load Transient

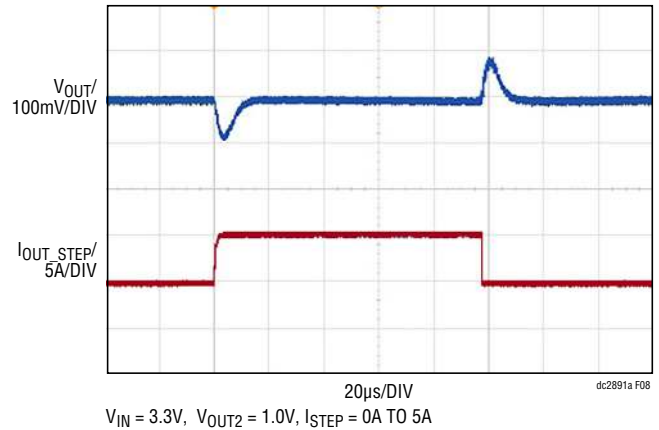

Figure 8. Measured Channel 2 Load Transient

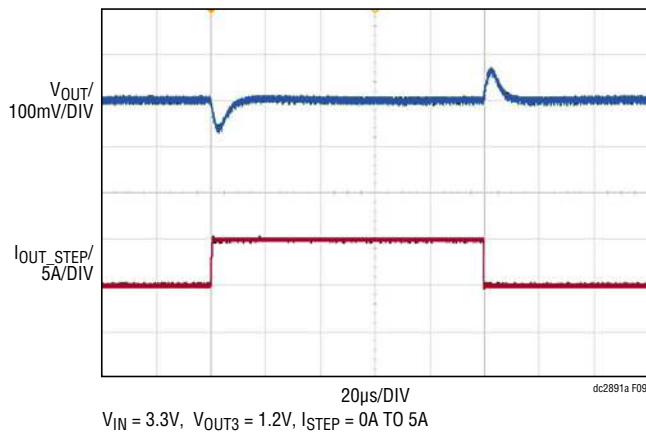

Figure 9. Measured Channel 3 Load Transient

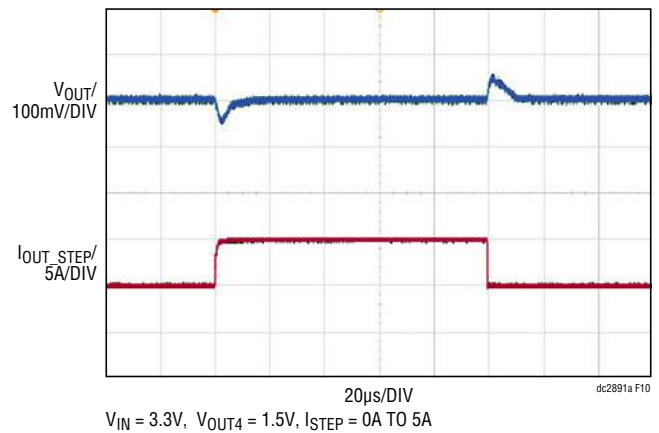

Figure 10. Measured Channel 4 Load Transient

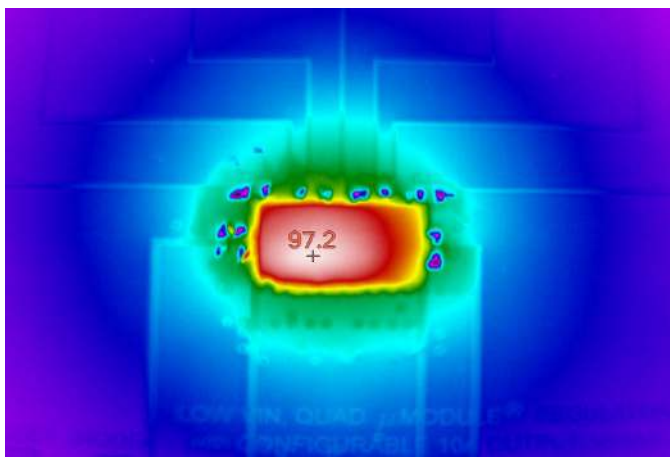

Figure 11. Thermal Image of LTM4670, $V_{IN} = 3.3V, V_{OUT1} = 0.8V$ at 10A, $V_{OUT2} = 1.0V$ at 10A, $V_{OUT3} = 1.2V$ at 10A, $V_{OUT4} = 1.5V$ at 10A, Ambient Temperature = 25°C, No Forced Airflow

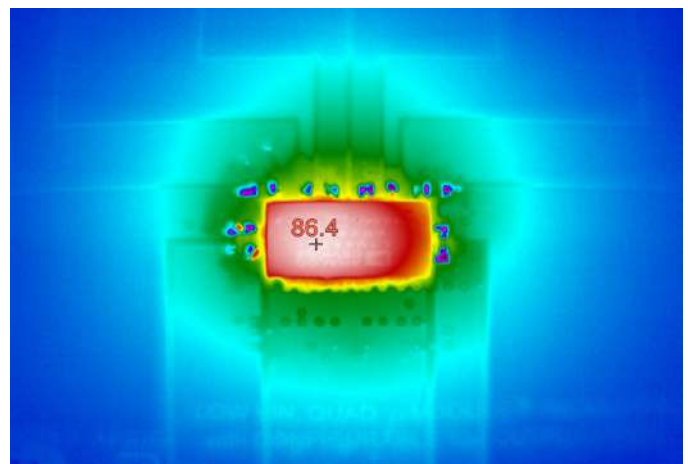

Figure 12. Thermal Image of LTM4670, $V_{IN} = 5.0V, V_{OUT1} = 0.8V$ at 10A, $V_{OUT2} = 1.0V$ at 10A, $V_{OUT3} = 1.2V$ at 10A, $V_{OUT4} = 1.5V$ at 10A, Ambient Temperature = 25°C, No Forced Airflow

DEMO MANUAL

DC2891A

PARTS LIST

ITEM	QTY	REFERENCE	PART DESCRIPTION	MANUFACTURER/PART NUMBER
Required Circuit Components				
1	8	C1, C3–C5, C47–C49, C54	CAP, 22 μ F, X5R, 10V, 20%, 0603	AVX, 0603ZD226MAT2A
2	1	C2	CAP, 150 μ F, ALUM ELECT, 10V, 20%, 8mm x 6.9mm	PANASONIC, 10SVP150MX
3	5	C8, C25, C26, C45, C46	CAP, 0.1 μ F, X7R, 50V, 10%, 0603	AVX, 06035C104KAT2A
4	4	C9, C17, C28, C36	CAP, 100 μ F, X5R, 6.3V, 20%, 0805	MURATA, GRM21BR60J107ME15K
5	12	C10–C12, C14–C16, C29, C30, C33–C35, C38	CAP, 22 μ F, X5R, 6.3V, 20%, 0805	KEMET, C0805C226M9PACTU
6	2	C18, C19	CAP, 4.7 μ F, X5R, 10V, 10%, 0603	SAMSUNG, CL10A475KP8NNNC
7	1	R3	RES., 100k, 1%, 1/10W, 0603, AEC-Q200	VISHAY, CRCW0603100KFKEA
8	1	R11	RES., 60.4k, 1%, 1/10W, 0603, AEC-Q200	VISHAY, CRCW060360K4FKEA
9	1	R12	RES., 30.1k, 1%, 1/10W, 0603, AEC-Q200	VISHAY, CRCW060330K1FKEA
10	4	R27, R29–R31	RES., 100k, 5%, 1/10W, 0603	PANASONIC, ERJ3GEYJ104V
11	1	R47	RES., 43.2k, 1%, 1/10W, 0603, AEC-Q200	PANASONIC, ERJ3EKF4322V
12	4	R60–R63	RES., 10 Ω , 1%, 1/10W, 0603	VISHAY, CRCW060310R0FKEA
13	1	RSET	RES., 24.9k, 1%, 1/10W, 0603	NIC, NRC06F2492TRF
14	1	U1	IC, LOW V_{IN} QUAD μ Module REGULATOR WITH CONFIGURABLE 10A OUTPUT ARRAY, BGA	ANALOG DEVICES, LTM4670EY#PBF
15	1	U2	IC, MULTIPHASE OSC WITH FREQ MOD, 10-PIN MSOP	ANALOG DEVICES, LTC6902CMS#PBF
Additional Demo Board Circuit Components				
1	0	C7, C13, C21, C22, C31, C32, C41, C42	CAP, OPTION, 0603	
2	0	C50–C53	CAP, OPTION, 1210	
3	0	L1	IND., OPTION, POWER, HIGH CURRENT, SMD	
4	11	R1, R2, R7, R8, R14–R16, R51, R53, R55, R57	RES., 0 Ω , 1/10W, 0603, AEC-Q200	VISHAY, CRCW06030000Z0EA
5	0	R9, R10, R13, R17, R18, R32–R35, R37–R40, R42–R45, R48–R50, R52, R54, R56, R58, R59, RMOD	RES., OPTION, 0603	
6	0	R36, R41, R46	RES., OPTION, 2512	
Hardware: For Demo Board Only				
1	14	E1–E14	TEST POINT, TURRET, 0.094" MTG. HOLE, PCB 0.062" THICK	MILL-MAX, 2501-2-00-80-00-00-07-0
2	11	J1–J7, J9–J12	CONN., BANANA JACK, FEMALE, THT, NON-INSULATED, SWAGE, 0.218"	KEYSTONE, 575-4
3	4	JP1–JP4	CONN., HDR, MALE, 1x3, 2mm, VERT, STR, THT, NO SUBS. ALLOWED	WURTH ELEKTRONIK, 62000311121
4	4	JP5–JP8	CONN., HDR, MALE, 2x3, 2mm, VERT, STR, THT	WURTH ELEKTRONIK, 62000621121
5	4	MP1–MP4	STANDOFF, NYLON, SNAP-ON, 0.25" (6.4mm)	KEYSTONE, 8831
6	8	XJP1–XJP8	CONN., SHUNT, FEMALE, 2-POS, 2mm	WURTH ELEKTRONIK, 60800213421

SCHEMATIC DIAGRAM

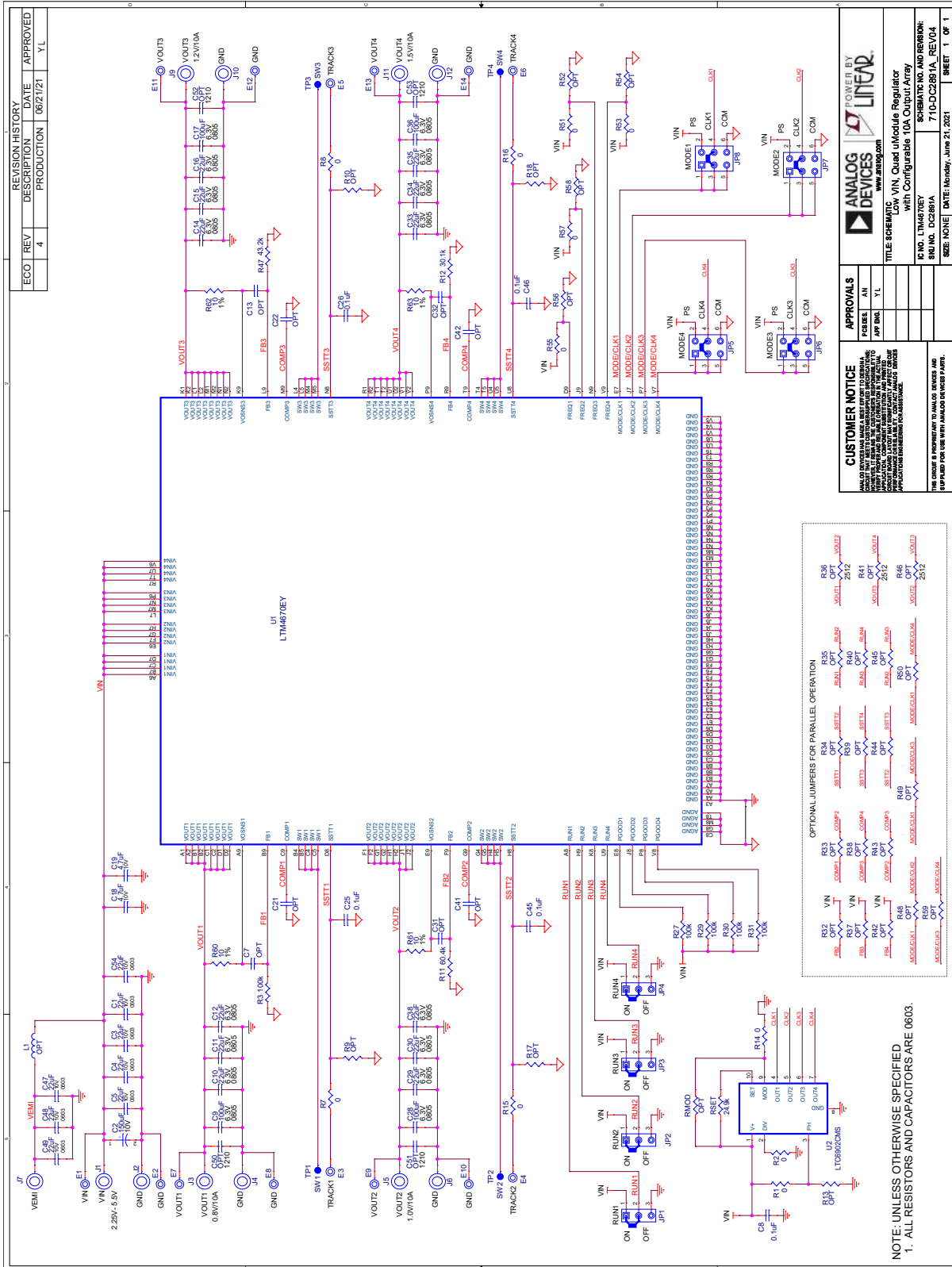

Information furnished by Analog Devices is believed to be accurate and reliable. However, no responsibility is assumed by Analog Devices for its use, nor for any infringements of patents or other rights of third parties that may result from its use. Specifications subject to change without notice. No license is granted by implication or otherwise under any patent or patent rights of Analog Devices.



ESD Caution

ESD (electrostatic discharge) sensitive device. Charged devices and circuit boards can discharge without detection. Although this product features patented or proprietary protection circuitry, damage may occur on devices subjected to high energy ESD. Therefore, proper ESD precautions should be taken to avoid performance degradation or loss of functionality.

Legal Terms and Conditions

By using the evaluation board discussed herein (together with any tools, components documentation or support materials, the "Evaluation Board"), you are agreeing to be bound by the terms and conditions set forth below ("Agreement") unless you have purchased the Evaluation Board, in which case the Analog Devices Standard Terms and Conditions of Sale shall govern. Do not use the Evaluation Board until you have read and agreed to the Agreement. Your use of the Evaluation Board shall signify your acceptance of the Agreement. This Agreement is made by and between you ("Customer") and Analog Devices, Inc. ("ADI"), with its principal place of business at One Technology Way, Norwood, MA 02062, USA. Subject to the terms and conditions of the Agreement, ADI hereby grants to Customer a free, limited, personal, temporary, non-exclusive, non-sublicensable, non-transferable license to use the Evaluation Board FOR EVALUATION PURPOSES ONLY. Customer understands and agrees that the Evaluation Board is provided for the sole and exclusive purpose referenced above, and agrees not to use the Evaluation Board for any other purpose. Furthermore, the license granted is expressly made subject to the following additional limitations: Customer shall not (i) rent, lease, display, sell, transfer, assign, sublicense, or distribute the Evaluation Board; and (ii) permit any Third Party to access the Evaluation Board. As used herein, the term "Third Party" includes any entity other than ADI, Customer, their employees, affiliates and in-house consultants. The Evaluation Board is NOT sold to Customer; all rights not expressly granted herein, including ownership of the Evaluation Board, are reserved by ADI. CONFIDENTIALITY. This Agreement and the Evaluation Board shall all be considered the confidential and proprietary information of ADI. Customer may not disclose or transfer any portion of the Evaluation Board to any other party for any reason. Upon discontinuation of use of the Evaluation Board or termination of this Agreement, Customer agrees to promptly return the Evaluation Board to ADI. ADDITIONAL RESTRICTIONS. Customer may not disassemble, decompile or reverse engineer chips on the Evaluation Board. Customer shall inform ADI of any occurred damages or any modifications or alterations it makes to the Evaluation Board, including but not limited to soldering or any other activity that affects the material content of the Evaluation Board. Modifications to the Evaluation Board must comply with applicable law, including but not limited to the RoHS Directive. TERMINATION. ADI may terminate this Agreement at any time upon giving written notice to Customer. Customer agrees to return to ADI the Evaluation Board at that time. LIMITATION OF LIABILITY. THE EVALUATION BOARD PROVIDED HEREUNDER IS PROVIDED "AS IS" AND ADI MAKES NO WARRANTIES OR REPRESENTATIONS OF ANY KIND WITH RESPECT TO IT. ADI SPECIFICALLY DISCLAIMS ANY REPRESENTATIONS, ENDORSEMENTS, GUARANTEES, OR WARRANTIES, EXPRESS OR IMPLIED, RELATED TO THE EVALUATION BOARD INCLUDING, BUT NOT LIMITED TO, THE IMPLIED WARRANTY OF MERCHANTABILITY, TITLE, FITNESS FOR A PARTICULAR PURPOSE OR NON-INFRINGEMENT OF INTELLECTUAL PROPERTY RIGHTS. IN NO EVENT WILL ADI AND ITS LICENSORS BE LIABLE FOR ANY INCIDENTAL, SPECIAL, INDIRECT, OR CONSEQUENTIAL DAMAGES RESULTING FROM CUSTOMER'S POSSESSION OR USE OF THE EVALUATION BOARD, INCLUDING BUT NOT LIMITED TO LOST PROFITS, DELAY COSTS, LABOR COSTS OR LOSS OF GOODWILL. ADI'S TOTAL LIABILITY FROM ANY AND ALL CAUSES SHALL BE LIMITED TO THE AMOUNT OF ONE HUNDRED US DOLLARS (\$100.00). EXPORT. Customer agrees that it will not directly or indirectly export the Evaluation Board to another country, and that it will comply with all applicable United States federal laws and regulations relating to exports. GOVERNING LAW. This Agreement shall be governed by and construed in accordance with the substantive laws of the Commonwealth of Massachusetts (excluding conflict of law rules). Any legal action regarding this Agreement will be heard in the state or federal courts having jurisdiction in Suffolk County, Massachusetts, and Customer hereby submits to the personal jurisdiction and venue of such courts. The United Nations Convention on Contracts for the International Sale of Goods shall not apply to this Agreement and is expressly disclaimed.