

# PFCLLCSREVM034 User Guide

## User's Guide



Literature Number: SLUUC46  
June 2020

---



---



---

<b>1</b>	<b>Trademarks</b> .....	<b>7</b>
<b>2</b>	<b>Introduction</b> .....	<b>7</b>
<b>3</b>	<b>Description</b> .....	<b>7</b>
	3.1 Typical Applications .....	7
	3.2 Features .....	7
<b>4</b>	<b>Performance Specifications</b> .....	<b>8</b>
<b>5</b>	<b>Schematic Diagram</b> .....	<b>9</b>
<b>6</b>	<b>Test Points</b> .....	<b>11</b>
<b>7</b>	<b>Terminals</b> .....	<b>11</b>
<b>8</b>	<b>Test Setup</b> .....	<b>12</b>
	8.1 Test Equipment .....	12
	8.2 Recommended Test Setup .....	12
<b>9</b>	<b>Performance Data and Typical Characteristics Curves</b> .....	<b>13</b>
	9.1 Efficiency .....	13
	9.2 Standby Power .....	14
	9.3 Power Factor .....	14
	9.4 Total Harmonic Distortion .....	15
	9.5 Load Regulation .....	16
	9.6 Startup .....	17
	9.7 Output Ripple .....	21
	9.8 Load Transient .....	22
	9.9 LLC Loop Response .....	23
	9.10 Steady State Waveforms .....	23
	9.11 X Capacitor Discharge .....	25
<b>10</b>	<b>Assembly Drawings</b> .....	<b>25</b>
<b>11</b>	<b>List of Materials</b> .....	<b>27</b>

## List of Figures

1	PFLLCSREVM034 Schematic Diagram: PFC Section.....	9
2	PFLLCSREVM034 Schematic Diagram: LLC Section.....	10
3	PFLLCSREVM034 Test Setup Diagram .....	12
4	Efficiency vs Output Current .....	13
5	Power Factor vs Output Power.....	14
6	THD vs Output Current .....	15
7	Output Voltage vs Output Current .....	16
8	115Vrms Input Startup into No Load (CH1=PFC Output; CH2=AC Input; CH3=LLC Output) .....	17
9	115Vrms Input Startup into No Load Zoomed In (CH1=PFC Output; CH2=AC Input; CH3=LLC Output) .....	17
10	115Vrms Startup into Full Load (CH1=PFC Output; CH2=AC Input; CH3=LLC Output) .....	18
11	115Vrms Startup into Full Load Zoomed In (CH1=PFC Output; CH2=AC Input; CH3=LLC Output) .....	18
12	230Vrms Input Startup into No Load (CH1=PFC Output; CH2=AC Input; CH3=LLC Output) .....	19
13	230Vrms Startup into No Load Zoomed In (CH1=PFC Output; CH2=AC Input; CH3=LLC Output) .....	19
14	230Vrms Input Startup into Full Load (CH1=PFC Output; CH2=AC Input; CH3=LLC Output) .....	20
15	230Vrms Startup into Full Load Zoomed In (CH1=PFC Output; CH2=AC Input; CH3=LLC Output) .....	20
16	No Load Output Ripple (CH3=LLC Output AC Coupled) .....	21
17	Full Load Output Ripple (CH3=LLC Output AC Coupled) .....	21
18	No Load to Full Load Transient (CH3=LLC Output AC Coupled; CH4=Output Current) .....	22
19	No Load to Full Load Transient Zoomed In (CH3=LLC Output AC Coupled; CH4=Output Current) .....	22
20	LLC Loop Response .....	23
21	115Vrms Input, Full Load (CH1=PFC Switch Node; CH4=PFC Inductor Current) .....	23
22	230Vrms Input, Full Load (CH1=PFC Switch Node; CH4=PFC Inductor Current) .....	24
23	10mA Load (CH1=LLC Switch Node; CH4=LLC Resonant Current).....	24
24	X Capacitor Discharge (CH1=Voltage between Line/Neutral).....	25
25	Top Layer Assembly .....	25
26	Bottom Layer Assembly .....	26
27	Bottom Layer Copper .....	26

---

## List of Tables

1	PFLLCSREVM034 Electrical Performance Specifications .....	8
2	Test Points .....	11
3	List of Terminals .....	11
4	Efficiency Measurements.....	13
5	Standby Power Measurements.....	14
6	List of Materials.....	27

## General Texas Instruments High Voltage Evaluation (TI HV EMV) User Safety Guidelines



Always follow TI's set-up and application instructions, including use of all interface components within their recommended electrical rated voltage and power limits. Always use electrical safety precautions to help ensure your personal safety and those working around you. Contact TI's Product Information Center [http://ti.com/customer support](http://ti.com/customer_support) for further information.

**Save all warnings and instructions for future reference.**

### **WARNING**

**Failure to follow warnings and instructions may result in personal injury, property damage or death due to electrical shock and burn hazards.**

The term TI HV EVM refers to an electronic device typically provided as an open framed, unenclosed printed circuit board assembly. It is *intended strictly for use in development laboratory environments, solely for qualified professional users having training, expertise and knowledge of electrical safety risks in development and application of high voltage electrical circuits. Any other use and/or application are strictly prohibited by Texas Instruments.* If you are not suitable qualified, you should immediately stop from further use of the HV EVM.

#### 1. Work Area Safety:

- a. Keep work area clean and orderly.
- b. Qualified observer(s) must be present anytime circuits are energized.
- c. Effective barriers and signage must be present in the area where the TI HV EVM and its interface electronics are energized, indicating operation of accessible high voltages may be present, for the purpose of protecting inadvertent access.
- d. All interface circuits, power supplies, evaluation modules, instruments, meters, scopes, and other related apparatus used in a development environment exceeding 50Vrms/75VDC must be electrically located within a protected Emergency Power Off EPO protected power strip.
- e. Use stable and non-conductive work surface.
- f. Use adequately insulated clamps and wires to attach measurement probes and instruments. No freehand testing whenever possible.

#### 2. Electrical Safety:

As a precautionary measure, it is always good engineering practice to assume that the entire EVM may have fully accessible and active high voltages.

- a. De-energize the TI HV EVM and all its inputs, outputs and electrical loads before performing any electrical or other diagnostic measurements. Revalidate that TI HV EVM power has been safely de-energized.
- b. With the EVM confirmed de-energized, proceed with required electrical circuit configurations, wiring, measurement equipment hook-ups and other application needs, while still assuming the EVM circuit and measuring instruments are electrically live.
- c. Once EVM readiness is complete, energize the EVM as intended.

**WARNING**

While the EVM is energized, never touch the EVM or its electrical circuits, as they could be at high voltages capable of causing electrical shock hazard.

**3. Personal Safety**

- a. Wear personal protective equipment e.g. latex gloves or safety glasses with side shields or protect EVM in an adequate lucent plastic box with interlocks from accidental touch.

**Limitation for safe use:**

EVMs are not to be used as all or part of a production unit.

# **PFLLCSREVM034 User Guide**

---

---

---

## **1 Trademarks**

All trademarks are the property of their respective owners.

## **2 Introduction**

The purpose of the PFLLCSREVM034 is to aid in evaluation of the UCC256404 LLC resonant controller, UCC28056B transition mode PFC controller and UCC24624 dual channel synchronous rectification controller. The EVM features a transition mode boost PFC front end and isolated half bridge LLC converter with synchronous rectification. The EVM meets efficiency requirements of CoC Tier II and is built on low cost single layer PCB.

## **3 Description**

### **3.1 Typical Applications**

- Industrial AC-DC adapters
- Power tools
- Medical power supply
- Multi-functional printer
- Enterprise and cinema projector
- PC power supply
- Gaming console power supply

### **3.2 Features**

- Low cost single layer PCB
- AC Input voltage from 90 Vrms to 264Vrms
- Regulated 12-VDC typical output
- Full-load power of 168 W, or full-load current of 14 A
- High efficiency
- Optimized low power features enable extremely low standby power
- Advanced burst mode with burst soft-on and soft-off for minimized audible noise
- X-capacitor discharge
- Test points to facilitate device and topology evaluation

## 4 Performance Specifications

**Table 1. PFCLCSREVM034 Electrical Performance Specifications**

PARAMETER	TEST CONDITIONS	MIN	TYP	MAX	UNITS
<b>Input Characteristics</b>					
AC Voltage Range		90		264	Vrms
AC Voltage Frequency		47		63	Hz
<b>Output Characteristics</b>					
Output Voltage			12		V
Output Current				14	A
<b>System Characteristics</b>					
No Load Standby Power	115-Vrms Input		84.90		mW
No Load Standby Power	230-Vrms Input		113.59		mW
10% Efficiency	115-Vrms Input		80.96		%
10% Efficiency	230-Vrms Input		80.60		%
4pt Average Efficiency	115-Vrms Input		90.05		%
4pt Average Efficiency	230-Vrms Input		90.89		%
Operating Temperature	Natural Convection		25		°C



5 Schematic Diagram

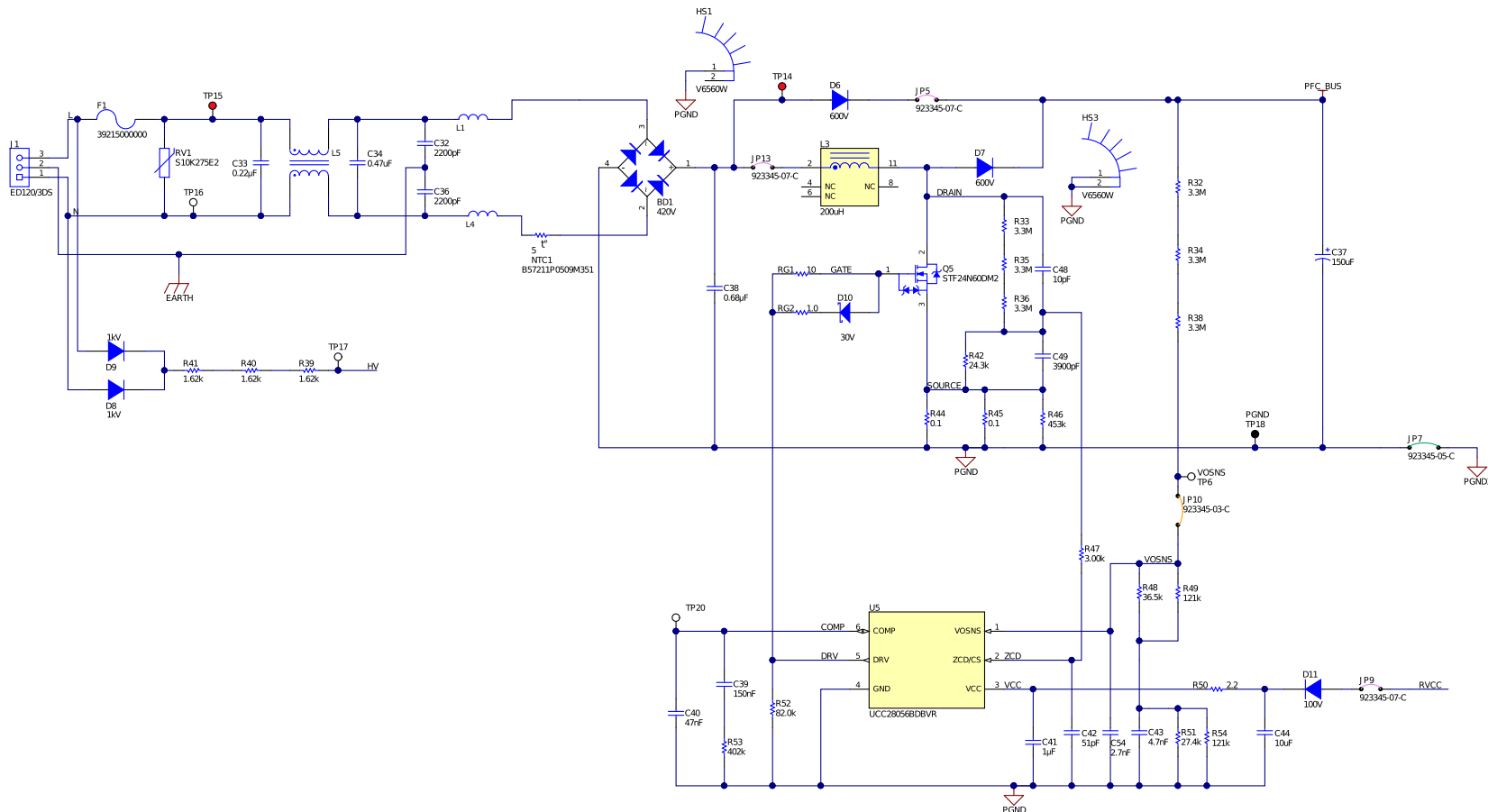

Figure 1. PFLLCSREVM034 Schematic Diagram: PFC Section

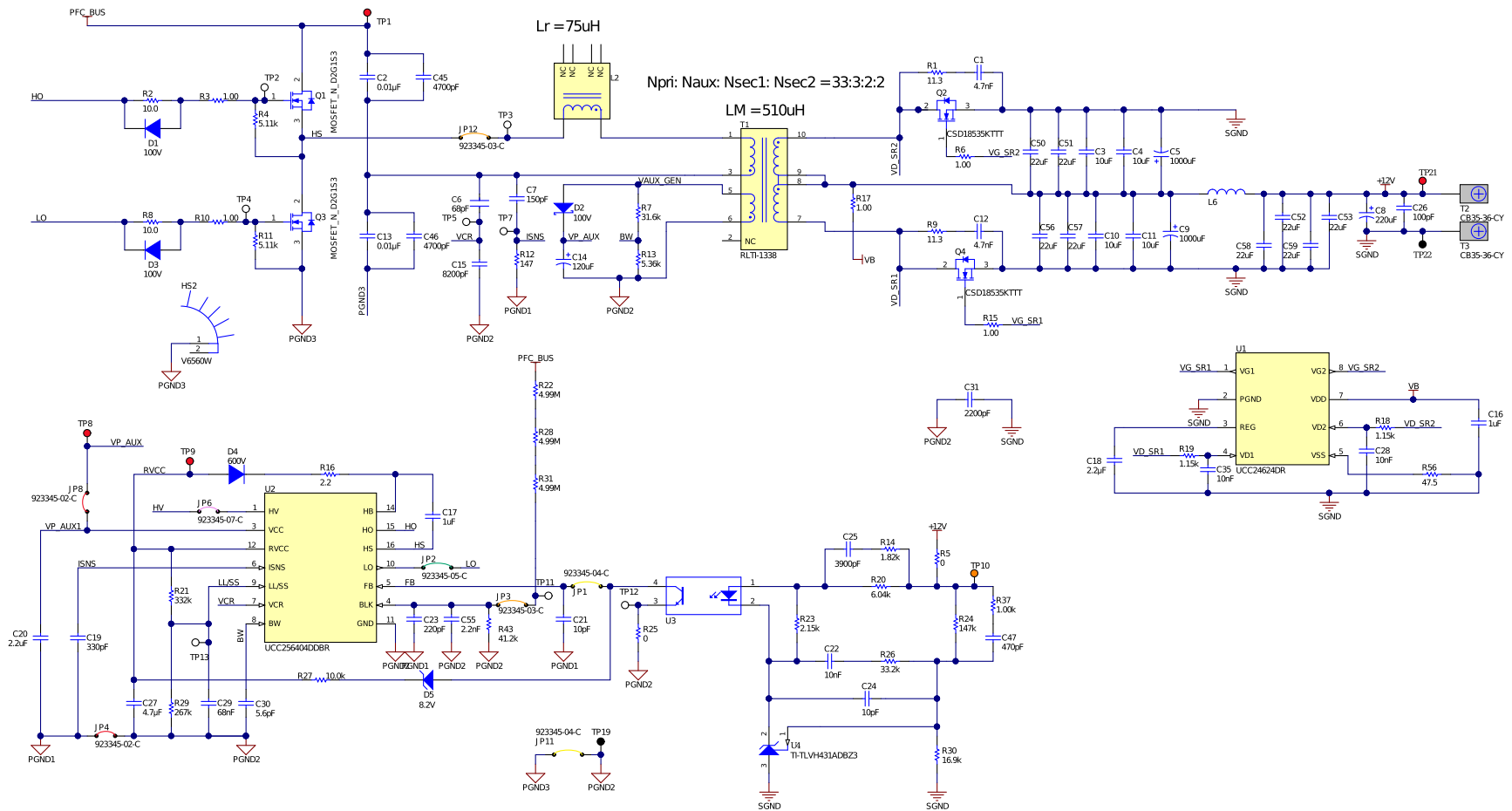

Figure 2. PFLLCSREVM034 Schematic Diagram: LLC Section

## 6 Test Points

Table 2 lists the EVM test points.

**Table 2. Test Points**

TEST POINTS	NAME	DESCRIPTION
TP1	PFC Bus	PFC Output Voltage
TP2	HO	Primary-side high side MOSFET gate, Q1
TP3	HS	LLC Switch Node
TP4	LO	Primary-side low side MOSFET gate, Q3
TP5	VCR	Resonant Capacitor Voltage Sense
TP6	VOSNS	PFC Output Voltage Sense
TP7	ISNS	Resonant Current Sense
TP8	VCC	VCC voltage
TP9	RVCC	RVCC Voltage
TP10	VOUT	Output voltage positive terminal
TP11	INJECT	Small Signal Injection Terminal
TP12	FB_Current	Feedback current measurement
TP13	LL/SS	Soft-Start and Light-Load Burst Mode Threshold
TP14	AC_Rect	Rectified AC input
TP15	AC_L	AC Line
TP16	AC_N	AC Neutral
TP17	HV	High Voltage Startup and X Capacitor Discharge
TP18	PGND	Primary Ground
TP19	PGND	Primary Ground
TP20	COMP	PFC Controller Compensation
TP21	VOUT	Output Voltage
TP22	SGND	Secondary Ground

## 7 Terminals

Table 3 lists the EVM terminals.

**Table 3. List of Terminals**

TERMINAL	NAME	DESCRIPTION
J1	AC Input	3-pin, AC power input, 90–264 V <sub>RMS</sub>
T2	VOUT	Output voltage positive terminal
T3	SGND	Output voltage ground terminal

## 8 Test Setup

### 8.1 Test Equipment

**AC Voltage Source:** Capable of single-phase output AC voltage 85 to 265 VAC, 47 to 63 Hz, adjustable, with minimum power rating 100 W and current limit function. The AC voltage source to be used should meet IEC 60950 reinforced insulation requirement.

**DC Digital Multimeter:** One unit capable of 0-VDC to 450-VDC input range, four digit display preferred; and one unit capable of 0-VDC to 20-VDC input range, four digit display preferred.

**Output Load:** : DC load capable of receiving 0 VDC to 20 VDC, 0 A to 14 A, and 0 W to 300 W or greater, with the capability to display information such as load current and load power.

**Oscilloscope:** Capable of 500-MHz full bandwidth, digital or analog: if digital, 5 Gsps, or better.

**Fan:** 200 to 400 LFM forced air cooling is recommended, but not required.

**Recommended Wire Gauge:** Capable of 25 A, or better than #14 AWG, with the total length of wire less than 8 feet (4 feet input and 4 feet return).

### 8.2 Recommended Test Setup

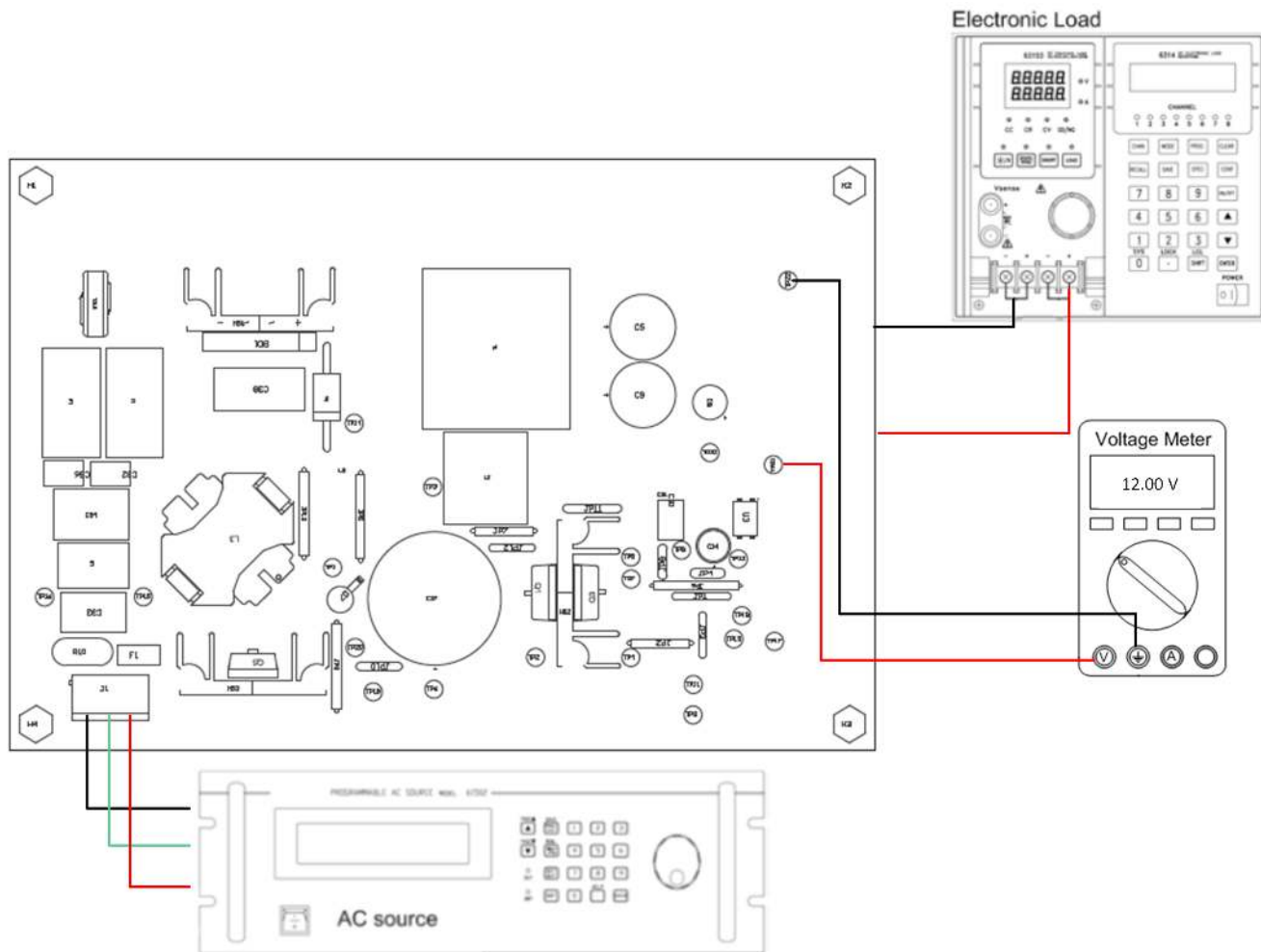

**Figure 3. PFLLCSREVM034 Test Setup Diagram**

**WARNING**

High voltages that may cause injury exist on this evaluation module (EVM). Please ensure all safety procedures are followed when working on this EVM. Never leave a powered EVM unattended.

## 9 Performance Data and Typical Characteristics Curves

### 9.1 Efficiency

Figure 4 illustrates the efficiency vs output current.

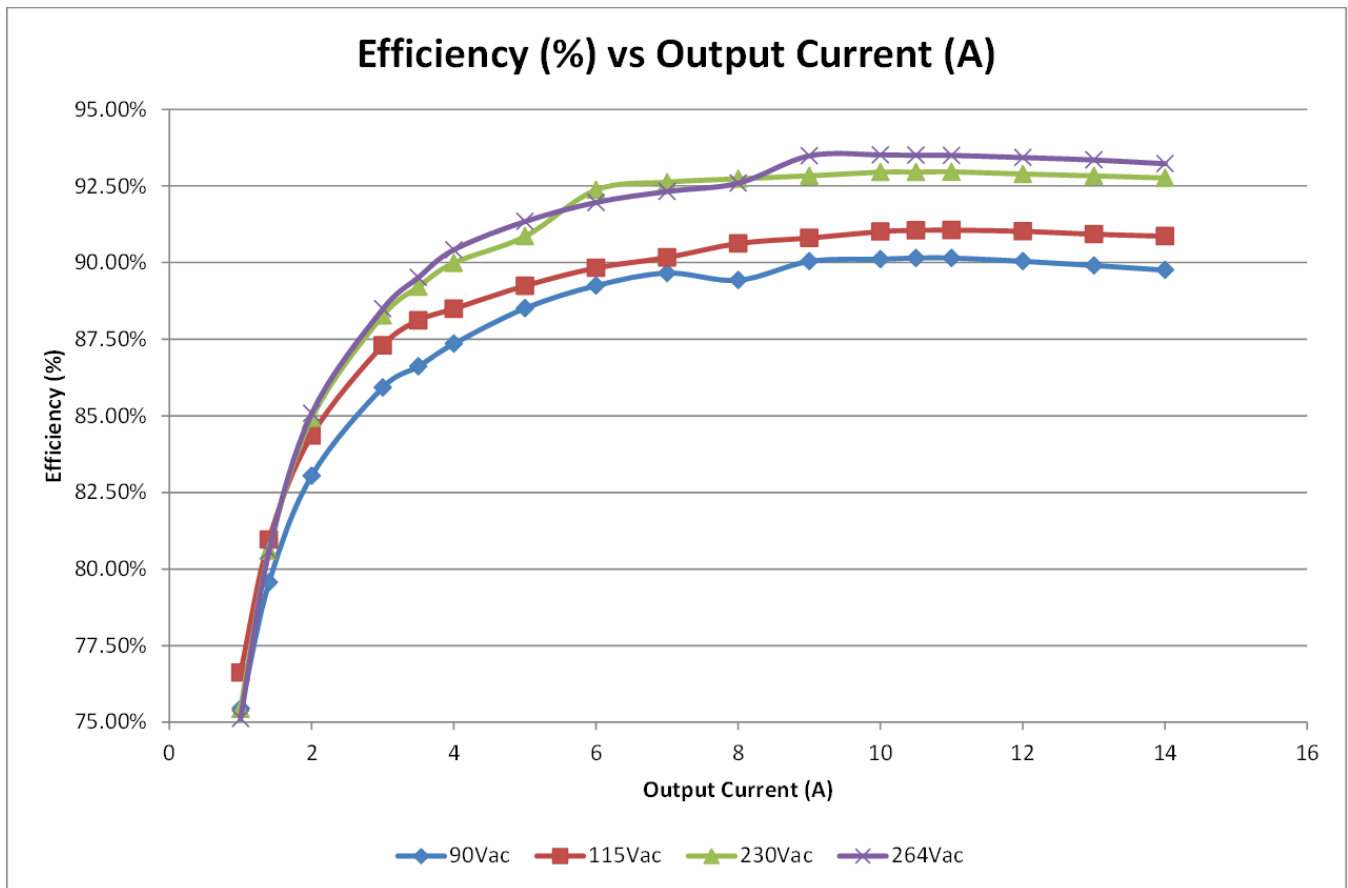

Figure 4. Efficiency vs Output Current

Table 4 summarizes the 10% and 4pt average efficiency.

Table 4. Efficiency Measurements

Input Voltage (Vrms)	10% Load Efficiency	25% Load Efficiency	50% Load Efficiency	75% Load Efficiency	100% Load Efficiency	4pt Average Efficiency
90	79.56%	86.61%	89.66%	90.15%	89.76%	89.05%
115	80.96%	88.11%	90.17%	91.05%	90.86%	90.05%
230	80.60%	89.21%	92.63%	92.95%	92.76%	91.89%
264	80.59%	89.51%	92.32%	93.50%	92.14%	92.14%

### 9.2 Standby Power

Table 5 summarizes the input power performance at light load.

**Table 5. Standby Power Measurements**

Input Voltage (Vrms)	Output Power (mW)	Input Power (mW)
115	0	84.896
	125	324.54
	250	558.78
230	0	113.594
	125	348.06
	250	574.90

### 9.3 Power Factor

Figure 5 illustrates the power factor vs output current.

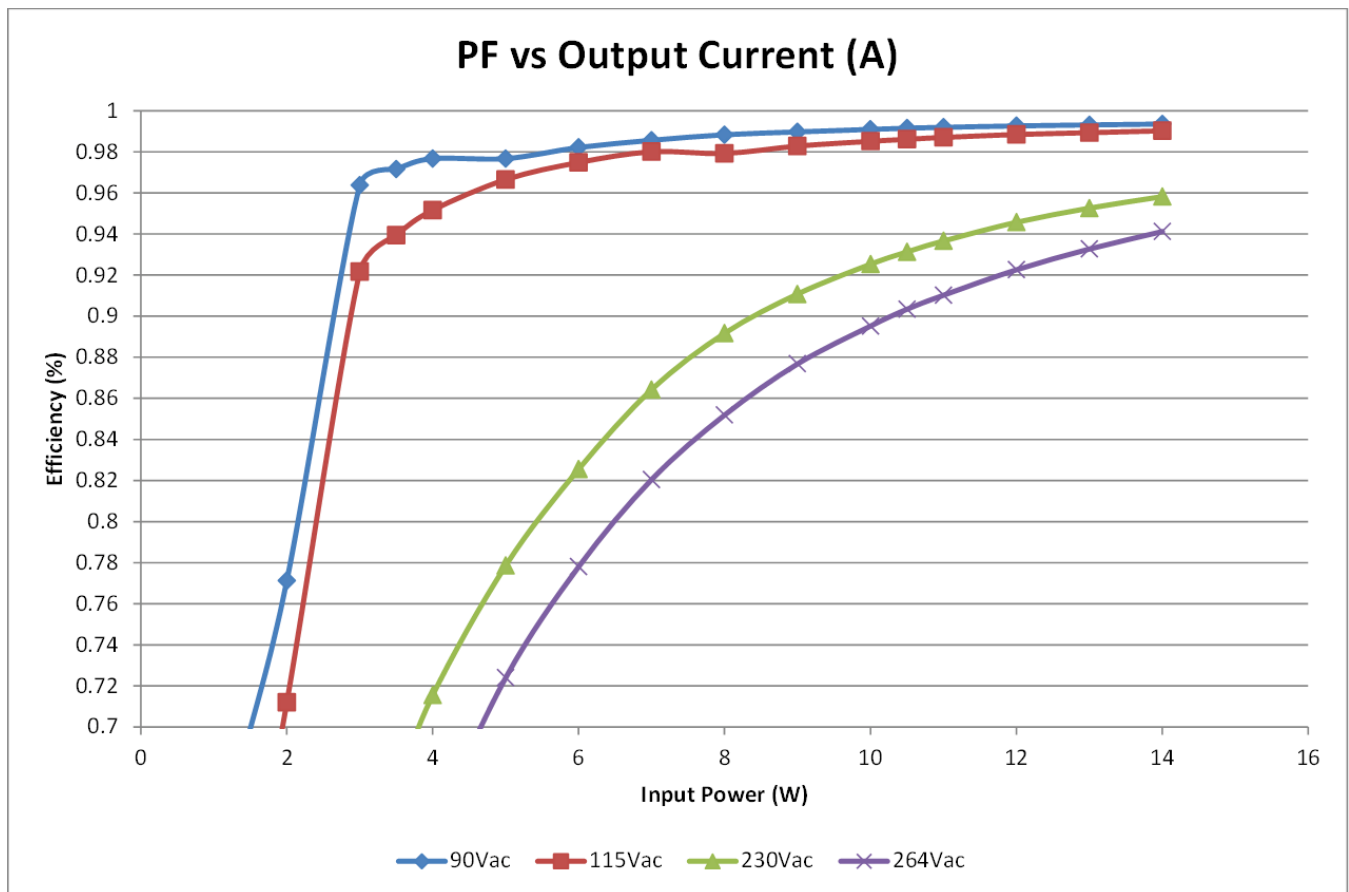

**Figure 5. Power Factor vs Output Power**

**9.4 Total Harmonic Distortion**

Figure 6 summarizes the total harmonic distortion vs output current.

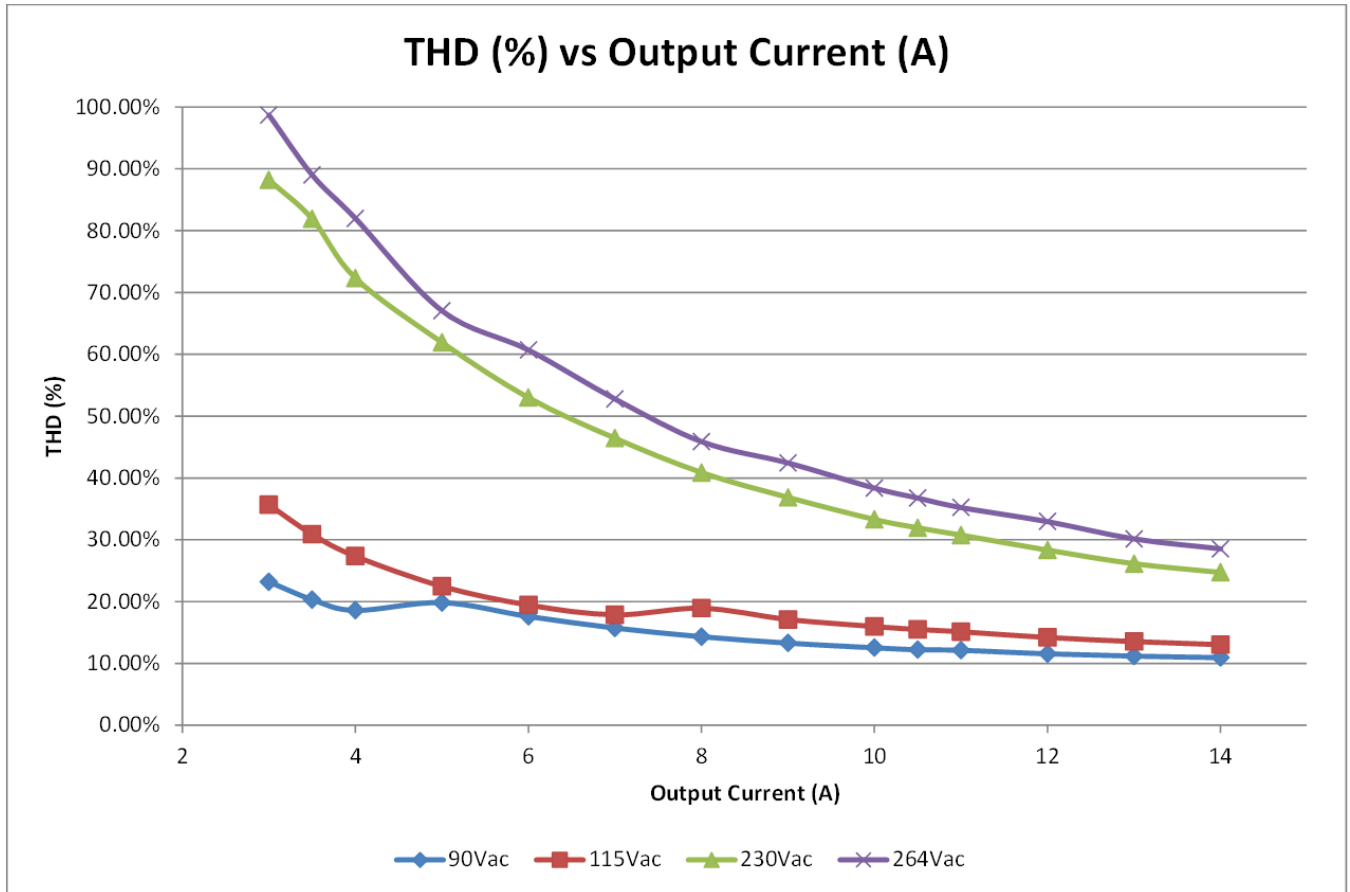

**Figure 6. THD vs Output Current**

### 9.5 Load Regulation

Figure 7 illustrates the output voltage regulation performance vs output current.

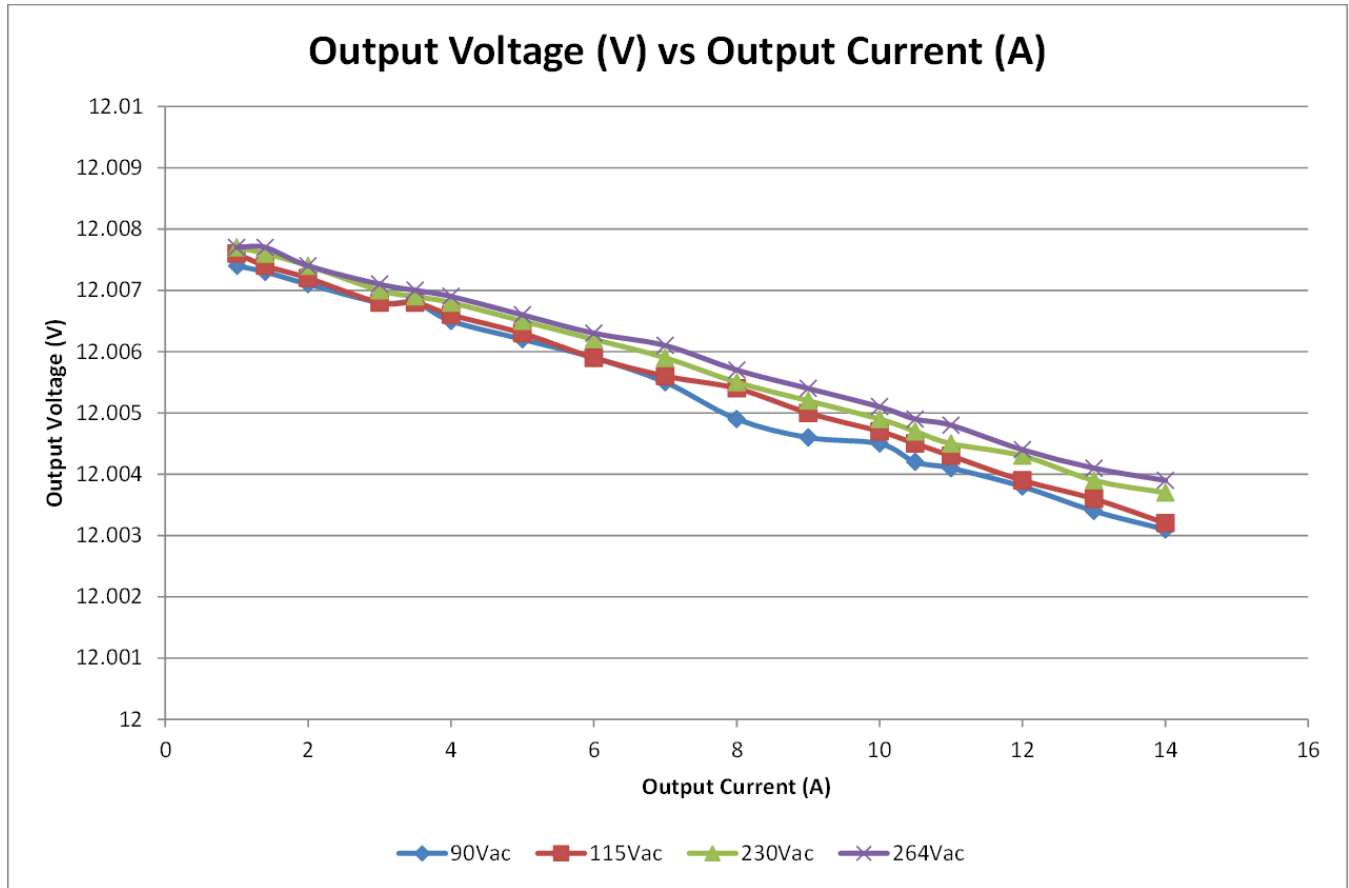

**Figure 7. Output Voltage vs Output Current**



## 9.6 Startup

### 9.6.1 115Vrms Input

Figure 8 and Figure 9 illustrates the startup behavior from 115Vrms input into no load condition.

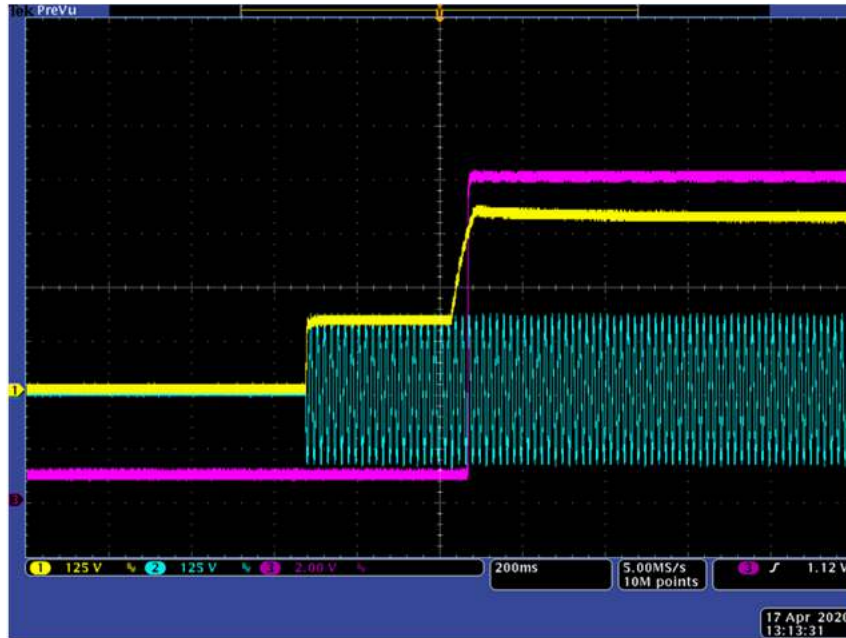

Figure 8. 115Vrms Input Startup into No Load (CH1=PFC Output; CH2=AC Input; CH3=LLC Output)

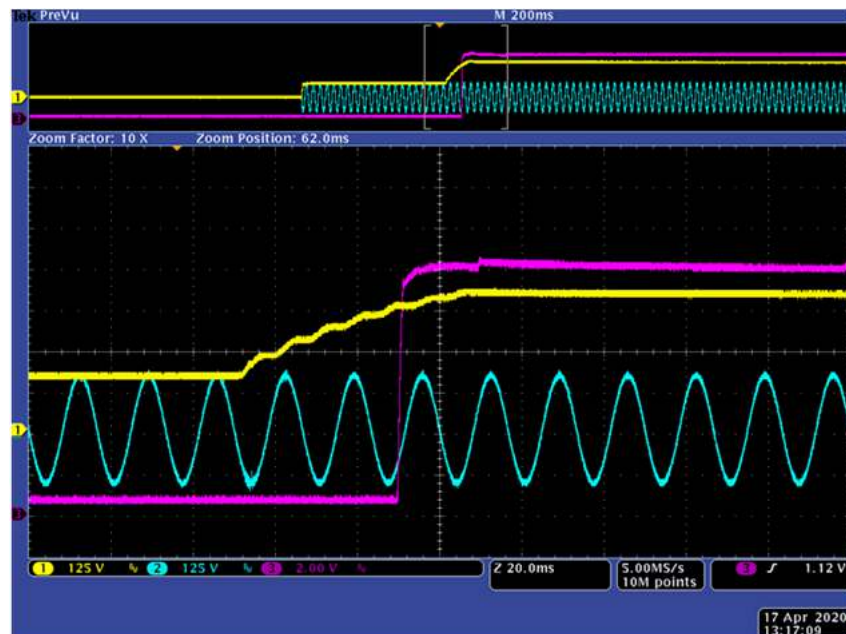

Figure 9. 115Vrms Input Startup into No Load Zoomed In (CH1=PFC Output; CH2=AC Input; CH3=LLC Output)

Figure 10 and Figure 11 illustrates the startup behavior from 115Vrms input into full load condition.

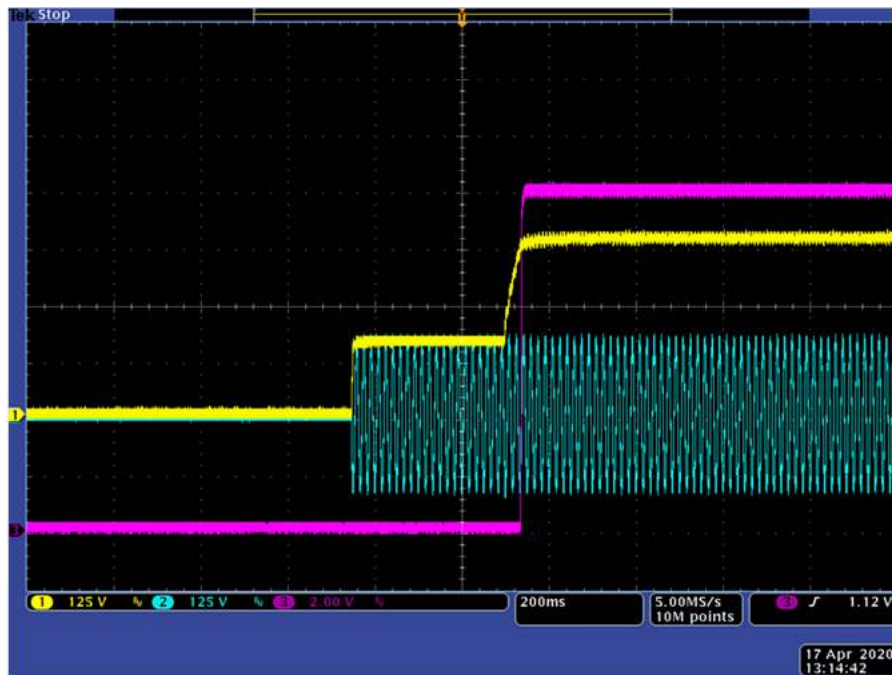

Figure 10. 115Vrms Startup into Full Load (CH1=PFC Output; CH2=AC Input; CH3=LLC Output)

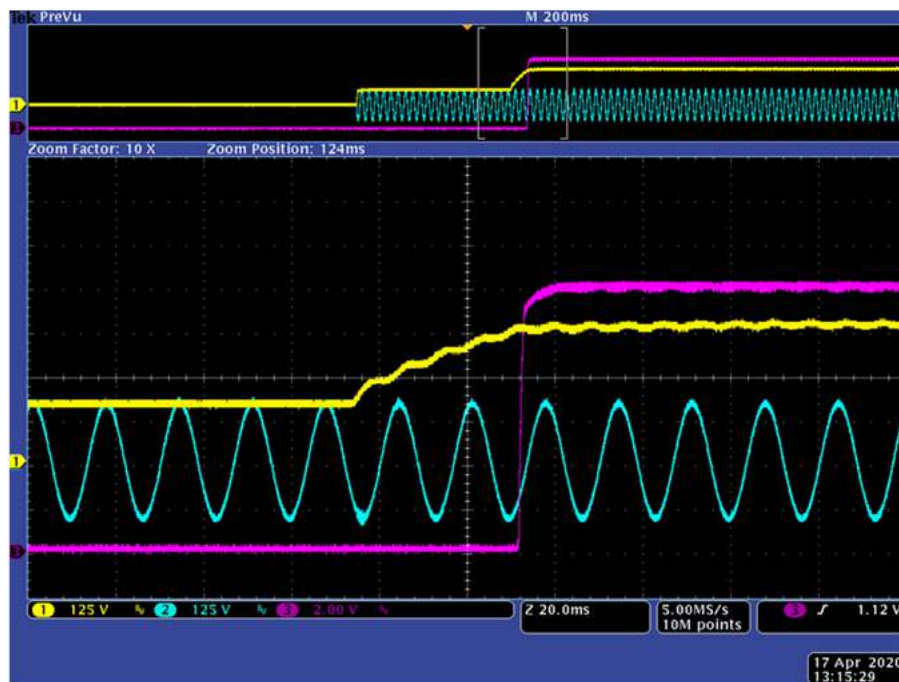

Figure 11. 115Vrms Startup into Full Load Zoomed In (CH1=PFC Output; CH2=AC Input; CH3=LLC Output)

### 9.6.2 230Vrms Input

Figure 12 and Figure 13 illustrates the startup behavior from 230Vrms input into no load condition.

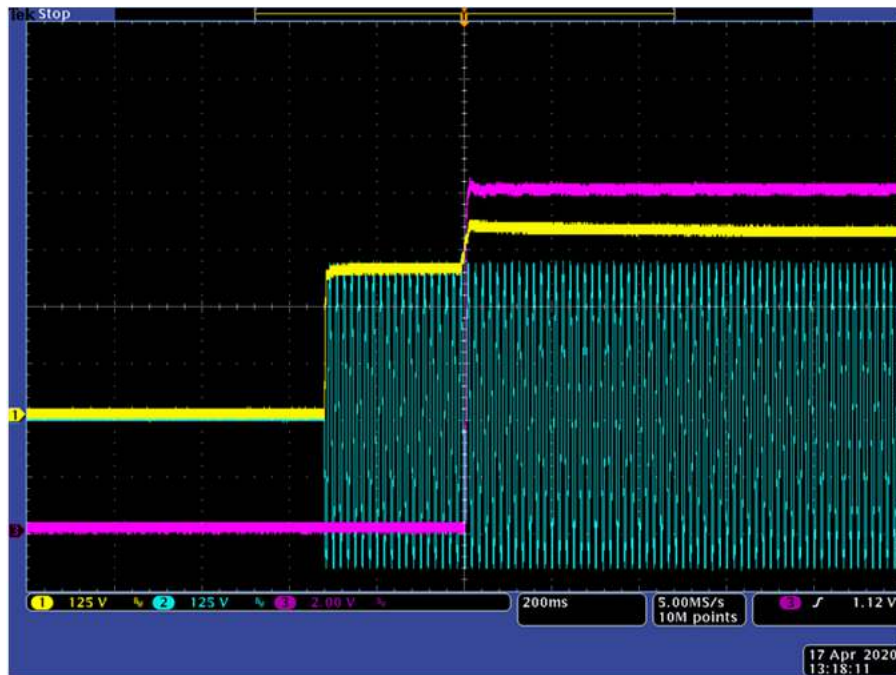

Figure 12. 230Vrms Input Startup into No Load (CH1=PFC Output; CH2=AC Input; CH3=LLC Output)

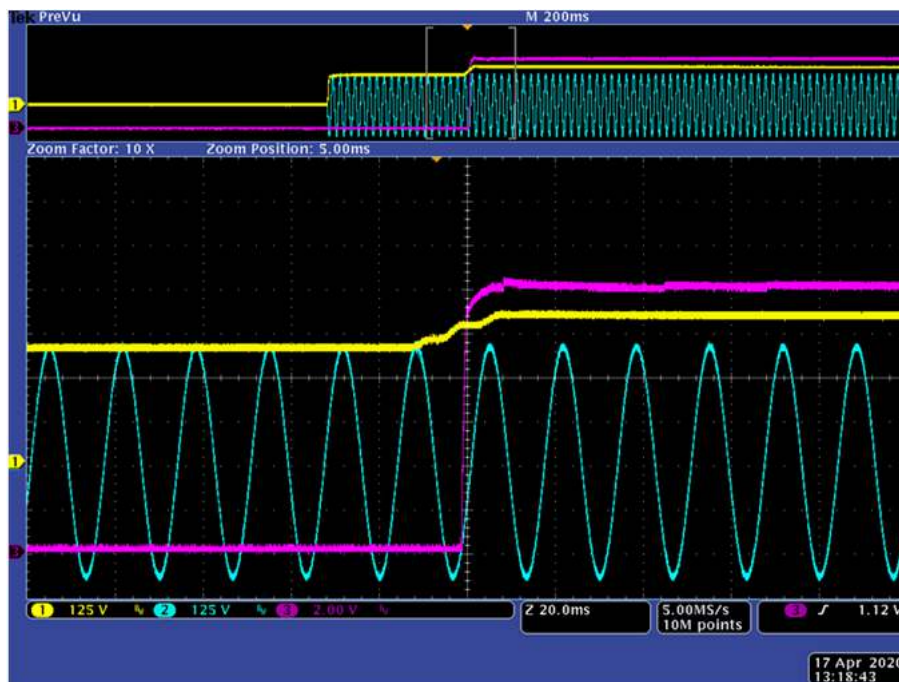

Figure 13. 230Vrms Startup into No Load Zoomed In (CH1=PFC Output; CH2=AC Input; CH3=LLC Output)

Figure 14 and Figure 15 illustrates the startup behavior from 230Vrms input into full load condition.

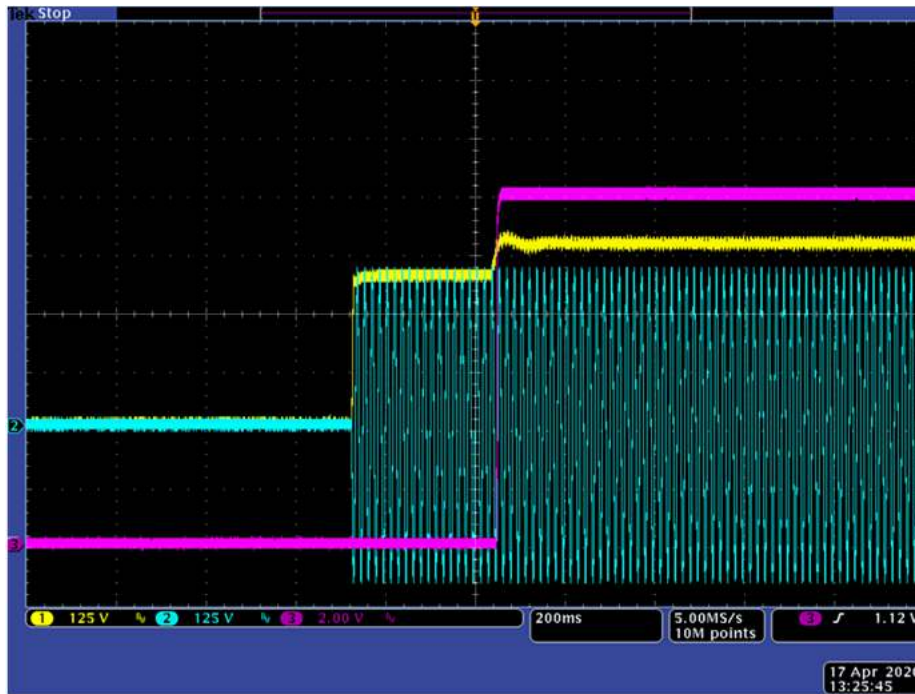

Figure 14. 230Vrms Input Startup into Full Load (CH1=PFC Output; CH2=AC Input; CH3=LLC Output)

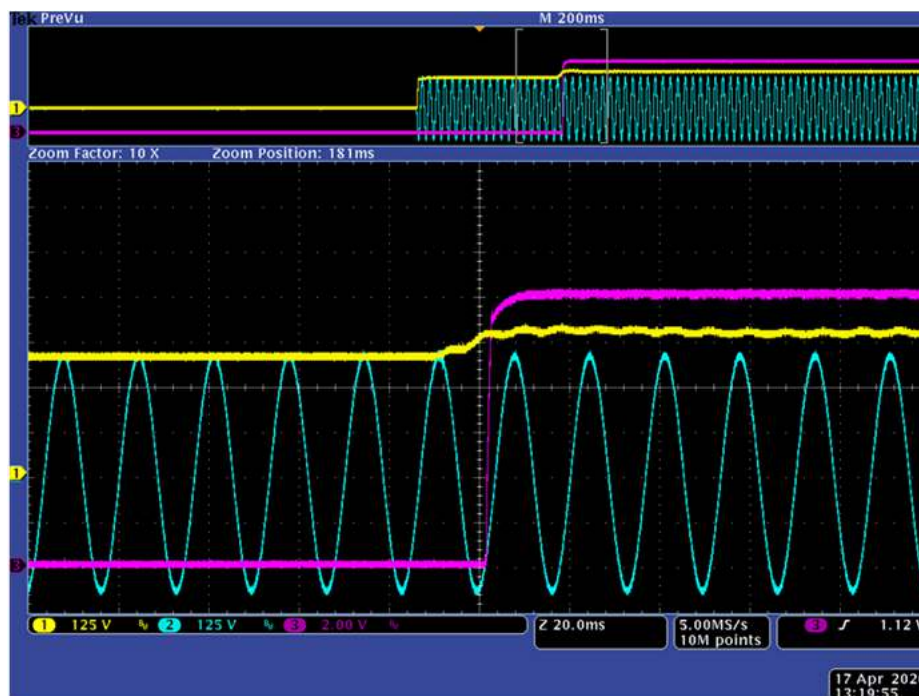

Figure 15. 230Vrms Startup into Full Load Zoomed In (CH1=PFC Output; CH2=AC Input; CH3=LLC Output)

### 9.7 Output Ripple

Figure 16 illustrates the LLC output voltage ripple at no load.

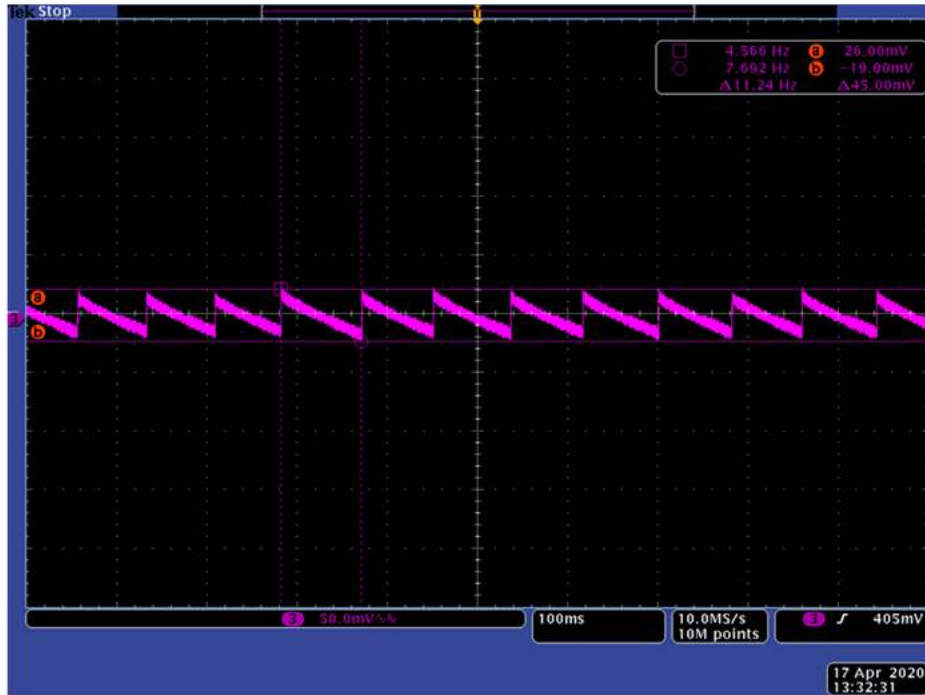

Figure 16. No Load Output Ripple (CH3=LLC Output AC Coupled)

Figure 17 illustrates the LLC output voltage ripple at full load.



Figure 17. Full Load Output Ripple (CH3=LLC Output AC Coupled)

### 9.8 Load Transient

Figure 18 and Figure 19 illustrates the no load to full load transient response.



Figure 18. No Load to Full Load Transient (CH3=LLC Output AC Coupled; CH4=Output Current)



Figure 19. No Load to Full Load Transient Zoomed In (CH3=LLC Output AC Coupled; CH4=Output Current)

### 9.9 LLC Loop Response

Figure 20 illustrates the LLC converter loop response.

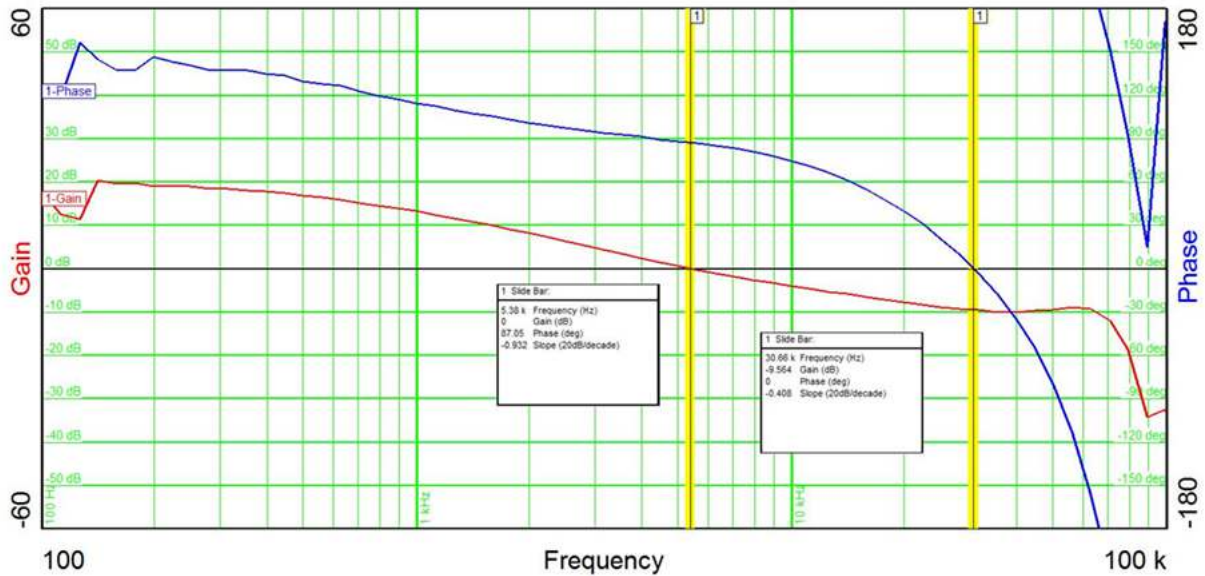

Figure 20. LLC Loop Response

### 9.10 Steady State Waveforms

#### 9.10.1 PFC

Figure 21 illustrates the PFC switch node and inductor current waveforms at full load with 115Vrms input.



Figure 21. 115Vrms Input, Full Load (CH1=PFC Switch Node; CH4=PFC Inductor Current)

Figure 22 illustrates the PFC switch node and inductor current waveforms at full load with 230Vrms input.

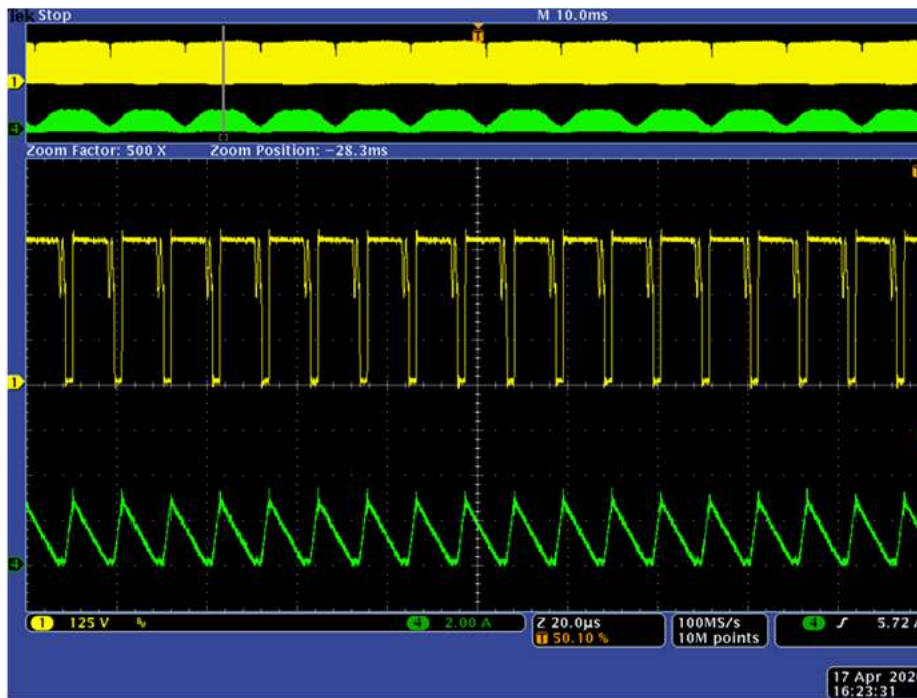

Figure 22. 230Vrms Input, Full Load (CH1=PFC Switch Node; CH4=PFC Inductor Current)

### 9.10.2 LLC

Figure 23 illustrates the LLC switch node and resonant current waveforms at 10mA load.

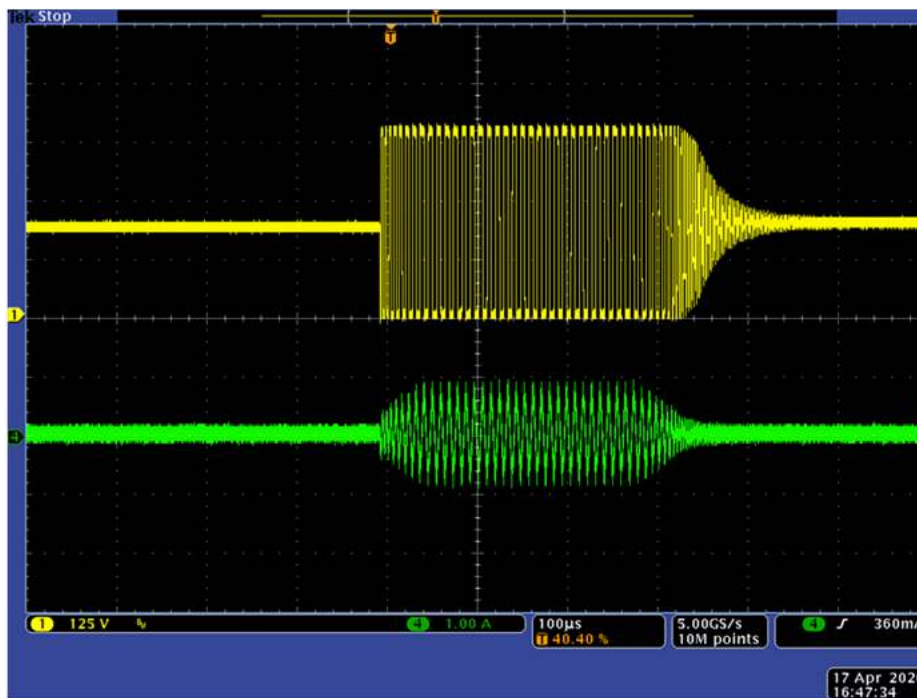

Figure 23. 10mA Load (CH1=LLC Switch Node; CH4=LLC Resonant Current)



### 9.11 X Capacitor Discharge

Figure 24 illustrates the X capacitor discharge performance at 264Vrms input and no load.

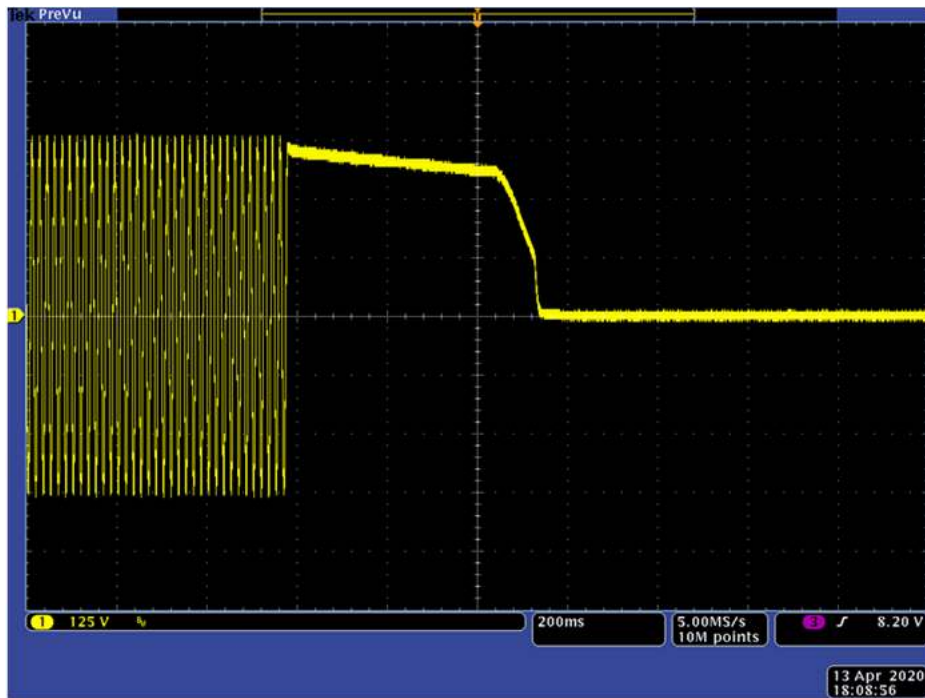

Figure 24. X Capacitor Discharge (CH1=Voltage between Line/Neutral)

## 10 Assembly Drawings

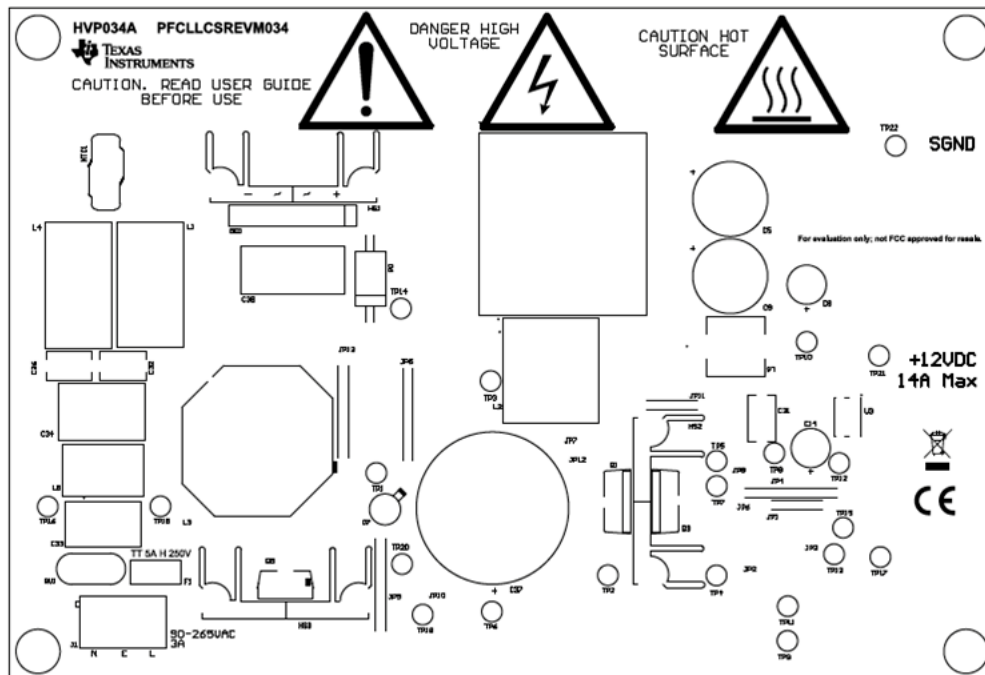
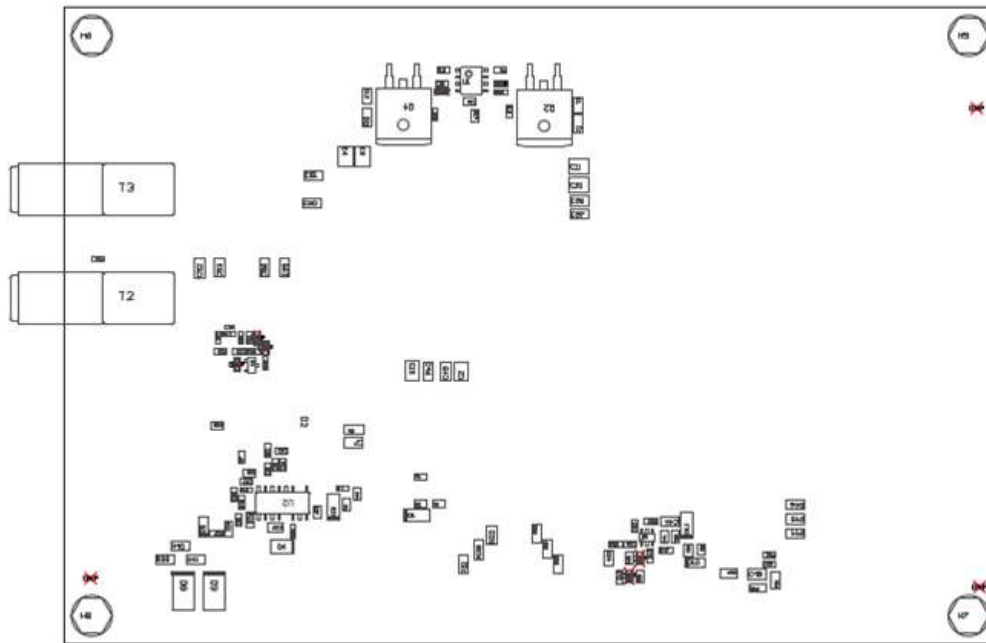
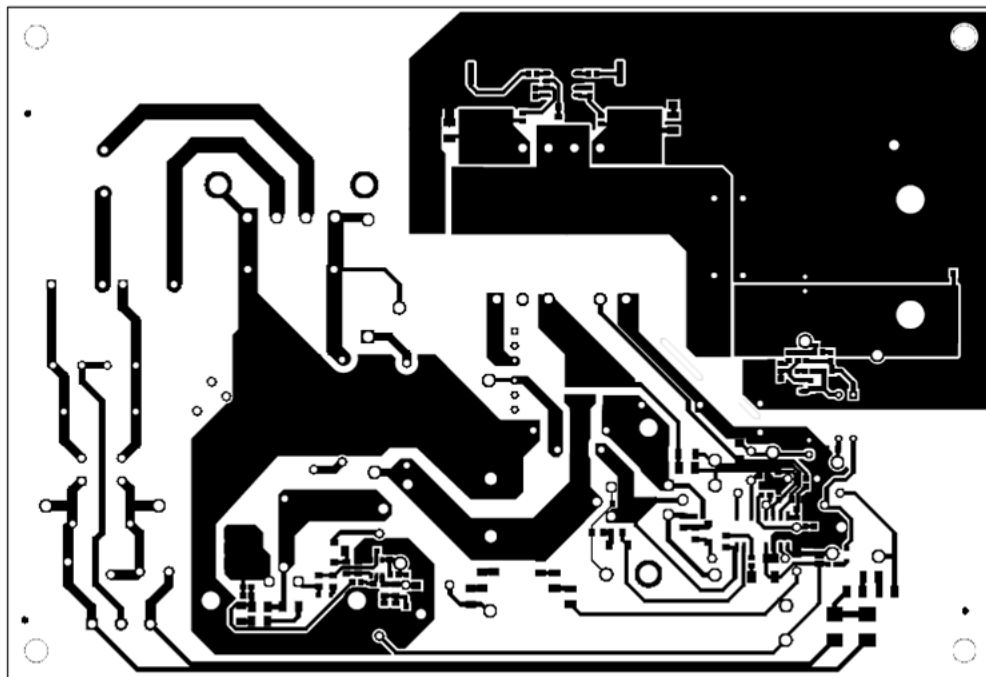

Figure 25. Top Layer Assembly



**Figure 26. Bottom Layer Assembly**



**Figure 27. Bottom Layer Copper**

## 11 List of Materials

**Table 6. List of Materials**

DES	QTY	DESCRIPTION	PART NUMBER
BD1	1	Diode, Switching-Bridge, 420 V, 8 A, TH	GBU8J-BP
C1, C12	2	Capacitor, ceramic, 4700 pF, 100 V, +/- 10%, X7R, 0805	GRM219R72A472KA01D
C2, C13	2	Capacitor, ceramic, 0.01 µF, 630 V, +/- 5%, C0G/NP0, AEC-Q200 Grade 1, 1210	CGA6J4C0G2J103J125A A
C3, C4, C10, C11	4	Capacitor, ceramic, 10 uF, 25 V, +/- 10%, X7R, 1210	12103C106KAT2A
C5, C9	2	CAP, AL, 1000 uF, 35 V, +/- 20%, 0.018 ohm, TH	EEU-FR1V102B
C6	1	Multilayer Ceramic Capacitors MLCC - SMD/SMT 68pF 1K V NPO 5%	CC1206JKNPOCBN680
C7	1	Capacitor, ceramic, 150 pF, 630 V, +/- 5%, C0G/NP0, 1206	GRM31A5C2J151JW01D
C8	1	Capacitor, aluminum, 220 uF, 16 V, +/- 20%, TH	EKMG160ELL221MF11D
C14	1	Capacitor, aluminum, 120 uF, 35 V, +/- 20%, TH	35ZLQ120MEFC6.3X11
C15	1	Capacitor, ceramic, 8200 pF, 50 V, +/- 5%, C0G/NP0, 0805	GRM2195C1H822JA01D
C16, C17, C41	3	Capacitor, ceramic, 1 uF, 25 V, +/- 10%, X7R, 0805	C0805C105K3RACTU
C18	1	Capacitor, ceramic, 2.2 uF, 16 V, +/- 10%, X7R, 0603	EMK107BB7225KA-T
C19	1	Capacitor, ceramic, 330 pF, 50 V, +/- 5%, C0G/NP0, 0603	885012006060
C20	1	Capacitor, ceramic, 2.2 uF, 35 V, +/- 10%, X5R, 0603	GRM188R6YA225KA12D
C21	1	Capacitor, ceramic, 10 pF, 50 V, +/- 5%, C0G/NP0, 0603	06035A100JAT2A
C22	1	Capacitor, ceramic, 0.01 uF, 16 V, +/- 10%, X7R, 0603	C0603C103K4RACTU
C23	1	Capacitor, ceramic, 220 pF, 50 V, +/- 10%, X7R, 0603	C0603X221K5RACTU
C25	1	Capacitor, ceramic, 3900 pF, 50 V, +/- 5%, C0G/NP0, 0603	GRM1885C1H392JA01D
C26	1	Capacitor, ceramic, 100 pF, 25 V, +/- 10%, X7R, 0603	06033C101KAT2A
C27	1	Capacitor, ceramic, 4.7 uF, 25 V, +/- 10%, X7R, 0805	C2012X7R1E475K125AB
C29	1	Capacitor, ceramic, 0.068 uF, 50 V, +/- 10%, X7R, AEC-Q200 Grade 1, 0603	CGA3E2X7R1H683K080 AA
C30	1	Capacitor, ceramic, 5.6 pF, 50 V, +/- 5%, C0G/NP0, 0603	06035A5R6CAT2A
C31, C32, C36	3	Capacitor, ceramic, 2200 pF, X1 250 VAC/Y2 250 VAC, +/- 20%, E, 8x5mm	DE2E3KY222MA2BM01F
C33	1	Capacitor, film, 0.22 µF, 275 V, +/- 10%, TH	890324023028
C34	1	Capacitor, film, 0.47 uF, 275 V, +/- 10%, TH	890324024005
C37	1	Capacitor, aluminum, 150 uF, 450 V, +/- 20%, TH	ESMQ451VSN151MQ25 S
C38	1	Capacitor, film, 0.68 µF, 200 VAC/520 VDC, +/- 10%, TH	B32672P5684K000
C39	1	Capacitor, ceramic, 0.15 uF, 25 V, +/- 10%, X7R, 0603	GRM188R71E154KA01D
C40	1	Capacitor, ceramic, 0.047 µF, 50 V, +/- 5%, X7R, 0603	06035C473JAT2A
C42	1	Capacitor, ceramic, 51 pF, 50 V, +/- 1%, C0G/NP0, 0603	C0603C510F5GAC7867
C43	1	Capacitor, ceramic, 4700 pF, 50 V, +/- 10%, X7R, 0603	C0603X472K5RACTU
C44	1	Capacitor, ceramic, 10 uF, 25 V, +/- 10%, X7R, 1206	885012208069
C45, C46	2	Capacitor, ceramic, 4700 pF, 630 V, +/- 5%, C0G/NP0, AEC-Q200 Grade 1, 1206	CGA5F4C0G2J472J085A A
C48	1	Capacitor, ceramic, 10 pF, 630 V, +/- 5%, U2J, AEC-Q200 Grade 1, 1206	GCM31A7U2J100JX01D
C49	1	Capacitor, ceramic, 3900 pF, 100 V, +/- 5%, C0G/NP0, AEC-Q200 Grade 1, 0603	CGA3E1C0G2A392J080 AC
C50, C51, C52, C53, C56, C57, C58, C59	8	Capacitor, ceramic, 22 uF, 25 V, +/- 20%, X5R, 1206_190	C3216X5R1E226M160A B
C54	1	Capacitor, ceramic, 2700 pF, 50 V, +/- 10%, X7R, 0805	CC0805KRX7R9BB272
C55	1	Capacitor, ceramic, 2200 pF, 50 V, +/- 10%, X7R, 0603	C0603X222K5RACTU
D1, D3, D11	3	Diode, ultrafast, 100 V, 0.15 A, SOD-123	1N4148W-7-F

**Table 6. List of Materials (continued)**

DES	QTY	DESCRIPTION	PART NUMBER
D2	1	Diode, Schottky, 100 V, 2 A, AEC-Q101, SOD-123W	PMEG10020ELRX
D4	1	Diode, ultrafast, 600 V, 1 A, AEC-Q101, SMAF	ES1JAF
D5	1	Diode, Zener, 8.2 V, 200 mW, AEC-Q101, SOD-323	BZX384C8V2-HE3-08
D6	1	Diode, fast rectifier, 600 V, 3 A, TH	MR856G
D7	1	Power Rectifier, Ultra-Fast Recovery, Switch-mode, 4 A, 600 V	MUR460RLG
D8, D9	2	Diode, P-N, 1000 V, 1 A, SMB	RS1MB-13-F
D10	1	Diode, Schottky, 30 V, 0.35 A, SOD-323	BAT48JFILM
F1	1	Fuse, 5 A, 250VAC/VDC, TH	39215000000
H9, H10	2	Mounting kit For TO-220 heat sinks	4880SG
HS1, HS2, HS3	3	Heat sink TO-220	V6560W
J1	1	Terminal block, 5.08 mm, 3x1, brass, TH	ED120/3DS
JP1, JP11	2	Jumper wire, 400 mil spacing, yellow	923345-04-C
JP2, JP7	2	Jumper wire, 500mil spacing, green	923345-05-C
JP3, JP10, JP12	3	Jumper wire, 300mil spacing, orange	923345-03-C
JP4, JP8	2	Jumper wire, 200mil spacing, red	923345-02-C
JP5, JP6, JP9, JP13	4	Jumper wire, 700mil spacing, Violet, pkg of 150, TH	923345-07-C
L1, L4	2	150µH unshielded toroidal inductor 3.4A 62-mΩ max radial, vertical (Open)	2114-V-RC
L2	1	Resonant inductor	RLTI-1337
L3	1	Inductor, 200 uH, 0.235 ohm, TH	750316570
L5	1	Power common mode choke	750343092
L6	1	WE-HCIT THT high current inductor	78432018003
M1, M2, M3, M4	4	Thermal pad amber 18.42mm x 13.21mm rectangular	43-77-9G
NTC1	1	Thermistor NTC, 5 ohm, 20%, 13x6mm	B57211P0509M351
Q1, Q3	2	MOSFET, N-channel, 650 V, 20.7 A, TO-220AB	SPP20N65C3XKSA1
Q2, Q4	2	MOSFET, N-channel, 60 V, 200 A, KTT0002A (TO-263-2)	CSD18535KTTT
Q5	1	MOSFET, N-channel, 600 V, 18 A, TO-220FP	STF24N60DM2
R1, R9	2	Resistor, 11.3 Ω, 1%, 0.25 W, AEC-Q200 grade 0, 1206	ERJ-8ENF11R3V
R2, R8	2	Resistor, 10.0 Ω, 1%, 0.125 W, AEC-Q200 grade 0, 0805	CRCW080510R0FKEA
R3, R10, R17	3	Resistor, 1.00 Ω, 1%, 0.125 W, AEC-Q200 grade 0, 0805	CRCW08051R00FKEA
R4, R11	2	Resistor, 5.11 kΩ, 1%, 0.1 W, AEC-Q200 grade 0, 0603	CRCW06035K11FKEA
R5	1	Resistor, 0 Ω, 5%, 0.063 W, 0402	RC0402JR-070RL
R6, R15	2	Resistor, 1.00 Ω, 1%, 0.1 W, AEC-Q200 grade 0, 0603	CRCW06031R00FKEA
R7	1	Resistor, 31.6 kΩ, 1%, 0.1 W, 0603	RC0603FR-0731K6L
R12	1	Resistor, 147 Ω, 1%, 0.1 W, 0603	RC0603FR-07147RL
R13	1	Resistor, 5.36 kΩ, 1%, 0.1 W, 0603	CRCW06035K36FKEA
R14	1	Resistor, 1.82 kΩ, 1%, 0.1 W, 0603	RC0603FR-071K82L
R16	1	Resistor, 2.2 Ω, 5%, 0.1 W, AEC-Q200 grade 0, 0603	CRCW06032R20JNEA
R18, R19	2	Resistor, 1.15 kΩ, 1%, 0.1 W, 0603	RC0603FR-071K15L
R20	1	Resistor, 6.04 kΩ, 1%, 0.1 W, AEC-Q200 grade 0, 0603	CRCW06036K04FKEA
R21	1	Resistor, 332 kΩ, 1%, 0.125 W, AEC-Q200 grade 0, 0805	CRCW0805332KFKEA
R22, R28, R31	3	Resistor, 4.99 MΩ, 1%, 0.25 W, AEC-Q200 grade 0, 1206	CRCW12064M99FKEA
R23	1	Resistor, 2.15 kΩ, 1%, 0.1 W, 0603	RC0603FR-072K15L
R24	1	Resistor, 147 kΩ, 1%, 0.1 W, AEC-Q200 grade 0, 0603	CRCW0603147KFKEA
R25	1	Resistor, 0 Ω, 5%, 0.125 W, AEC-Q200 grade 0, 0805	CRCW08050000Z0EA
R26	1	Resistor, 33.2 kΩ, 1%, 0.1 W, 0603	RC0603FR-0733K2L
R27	1	Resistor, 10.0 kΩ, 1%, 0.1 W, AEC-Q200 grade 0, 0603	CRCW060310K0FKEA

**Table 6. List of Materials (continued)**

DES	QTY	DESCRIPTION	PART NUMBER
R29	1	Resistor, 267 k $\Omega$ , 1%, 0.125 W, AEC-Q200 grade 0, 0805	CRCW0805267KFKEA
R30	1	Resistor, 16.9 k $\Omega$ 1%, 0.1 W, AEC-Q200 grade 0, 0603	CRCW060316K9FKEA
R32, R33, R34, R35, R36, R38	6	3.3 MOhms $\pm$ 1% 0.25W, 1/4W chip resistor 1206 (3216 Metric) automotive AEC-Q200, high voltage thick film	KTR18EZPF3304
R39, R40, R41	3	Resistor, 1.62 k $\Omega$ , 1%, 0.25 W, AEC-Q200 grade 0, 1206	CRCW12061K62FKEA
R42	1	Resistor, 24.3 k $\Omega$ , 0.5%, 0.1 W, 0603	RT0603DRE0724K3L
R43	1	Resistor, 41.2 k $\Omega$ , 1%, 0.1 W, 0603	RC0603FR-0741K2L
R44, R45	2	Resistor, 0.1 $\Omega$ , 1%, 0.5 W, 1206	CSR1206FKR100
R46	1	Resistor, 453 k $\Omega$ , 1%, 0.25 W, AEC-Q200 grade 0, 1206	CRCW1206453KFKEA
R47	1	Resistor, 3.00 k $\Omega$ , 0.1%, 0.1 W, 0603	RG1608P-302-B-T5
R48	1	Resistor, 36.5 k $\Omega$ , 1%, 0.125 W, AEC-Q200 grade 0, 0805	ERJ-6ENF3652V
R50	1	Resistor, 2.2 $\Omega$ , 5%, 0.125 W, AEC-Q200 grade 0, 0805	CRCW08052R20JNEA
R51	1	Resistor, 27.4 k $\Omega$ , 1%, 0.125 W, AEC-Q200 grade 0, 0805	ERJ-6ENF2742V
R52	1	Resistor, 82.0 k $\Omega$ , 1%, 0.1 W, 0603	RC0603FR-0782KL
R53	1	Resistor, 402 k $\Omega$ , 1%, 0.1 W, AEC-Q200 grade 0, 0603	CRCW0603402KFKEA
R55	1	Resistor, 10 $\Omega$ , 5%, 0.125 W, AEC-Q200 grade 0, 0805	CRCW080510R0JNEA
R56	1	Resistor, 47.5 $\Omega$ , 1%, 0.1 W, 0603	CRCW060347R5FKEA
R57	1	Resistor, 1.0 $\Omega$ , 5%, 0.125 W, AEC-Q200 grade 0, 0805	CRCW08051R00JNEA
RV1	1	Varistor 275-V RMS 10MM radial, TH	S10K275E2
T1	1	LLC transformer	RLTI-1338
T2, T3	2	Terminal 50-A Lug	CB35-36-CY
TP1, TP8, TP9, TP14, TP15, TP21	6	Test point, multipurpose, red, TH	5010
TP2, TP3, TP4, TP5, TP6, TP7, TP11, TP12, TP13, TP16, TP17, TP20	12	Test point, multipurpose, white, TH	5012
TP10	1	Test point, multipurpose, orange, TH	5013
TP18, TP19, TP22	3	Test point, multipurpose, black, TH	5011
U1	1	High Performance Synchronous Rectifier Driver for LLC Resonant Converter, D0008A (SOIC-8)	UCC24624DR
U2	1	Wide Vin LLC Resonant Controller With High-Voltage Start Up Enabling Low Standby Power, DDB0014A (SOIC-14)	UCC256404DDBR
U3	1	Optocoupler, 5.3 kV, 50-600% CTR, TH	VO618A
U4	1	Low-Voltage Adjustable Precision Shunt Regulator	TLVH431ACDBZT
U5	1	6-Pin Single-Phase Transition-Mode PFC Controller, DBV0006A (SOT-6)	UCC28056BDBVR

## IMPORTANT NOTICE AND DISCLAIMER

TI PROVIDES TECHNICAL AND RELIABILITY DATA (INCLUDING DATASHEETS), DESIGN RESOURCES (INCLUDING REFERENCE DESIGNS), APPLICATION OR OTHER DESIGN ADVICE, WEB TOOLS, SAFETY INFORMATION, AND OTHER RESOURCES "AS IS" AND WITH ALL FAULTS, AND DISCLAIMS ALL WARRANTIES, EXPRESS AND IMPLIED, INCLUDING WITHOUT LIMITATION ANY IMPLIED WARRANTIES OF MERCHANTABILITY, FITNESS FOR A PARTICULAR PURPOSE OR NON-INFRINGEMENT OF THIRD PARTY INTELLECTUAL PROPERTY RIGHTS.

These resources are intended for skilled developers designing with TI products. You are solely responsible for (1) selecting the appropriate TI products for your application, (2) designing, validating and testing your application, and (3) ensuring your application meets applicable standards, and any other safety, security, or other requirements. These resources are subject to change without notice. TI grants you permission to use these resources only for development of an application that uses the TI products described in the resource. Other reproduction and display of these resources is prohibited. No license is granted to any other TI intellectual property right or to any third party intellectual property right. TI disclaims responsibility for, and you will fully indemnify TI and its representatives against, any claims, damages, costs, losses, and liabilities arising out of your use of these resources.

TI's products are provided subject to TI's Terms of Sale ([www.ti.com/legal/termsofsale.html](http://www.ti.com/legal/termsofsale.html)) or other applicable terms available either on [ti.com](http://ti.com) or provided in conjunction with such TI products. TI's provision of these resources does not expand or otherwise alter TI's applicable warranties or warranty disclaimers for TI products.

Mailing Address: Texas Instruments, Post Office Box 655303, Dallas, Texas 75265  
Copyright © 2020, Texas Instruments Incorporated