

TOP VIEW

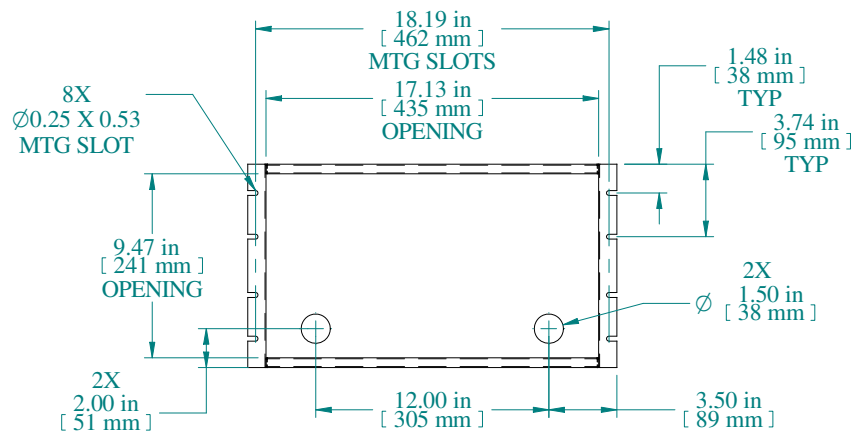

FRONT VIEW

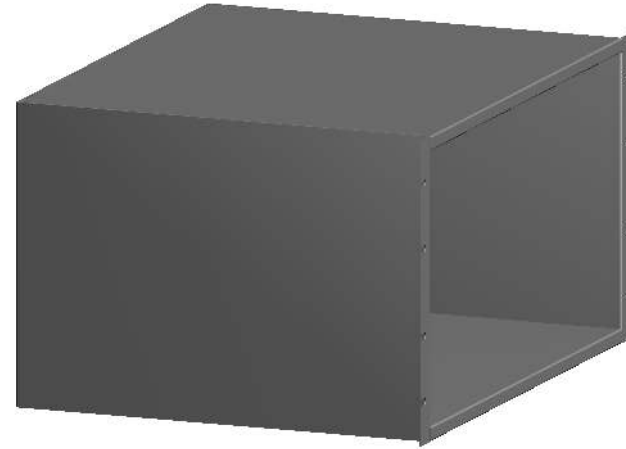
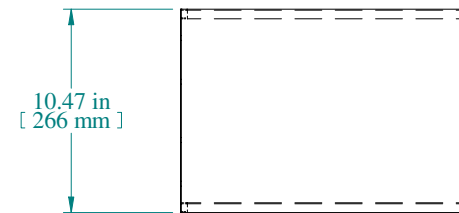

SIDE VIEW

PART NUMBERS	
RASE1901015WH2	PAINTED HAMMOND WHITE

NOTES
Maximum Weight 75 lb Mounting Hardware Not Supplied

Data subject to change without notice. Isometric drawing not to scale.

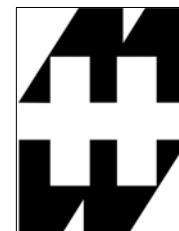

**HAMMOND
MANUFACTURING™**

www.hammondmfg.com

PART NO. RASE1901015