

VIEW C
SCALE 8:1

SEE NOTE 5

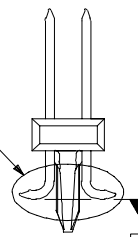

SEE DETAIL D
SHEET 2

SEATING PLANE
DEFINED BY
WHOLE CONNECTOR

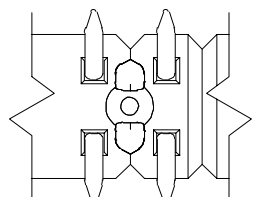

VIEW B
SCALE 8:1

Ø .30 / .012 A B C

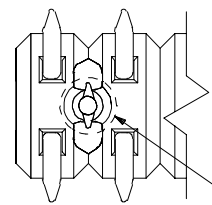

VIEW A
SCALE 8:1

SEE NOTE 5

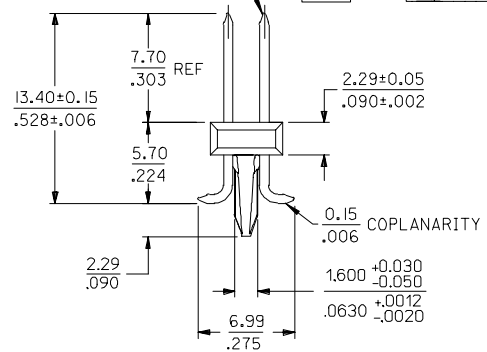

1.700±0.080
.0669±.0030
UNPLATED
THRU-HOLE

Ø .10 / .004

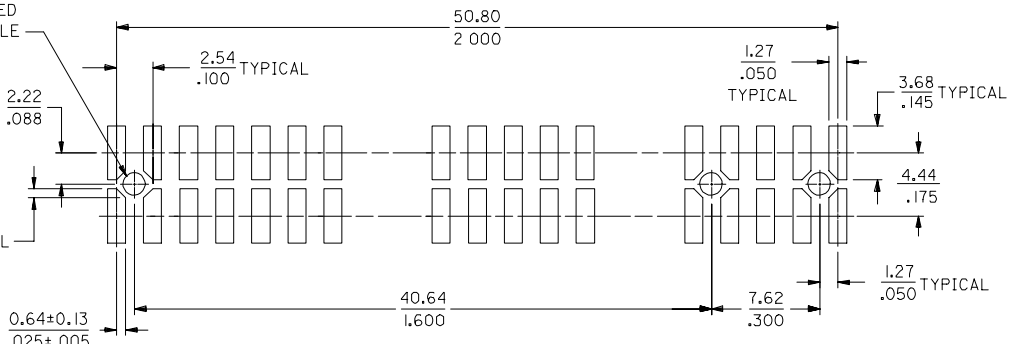

RECOMMENDED CIRCUIT BOARD LAYOUT

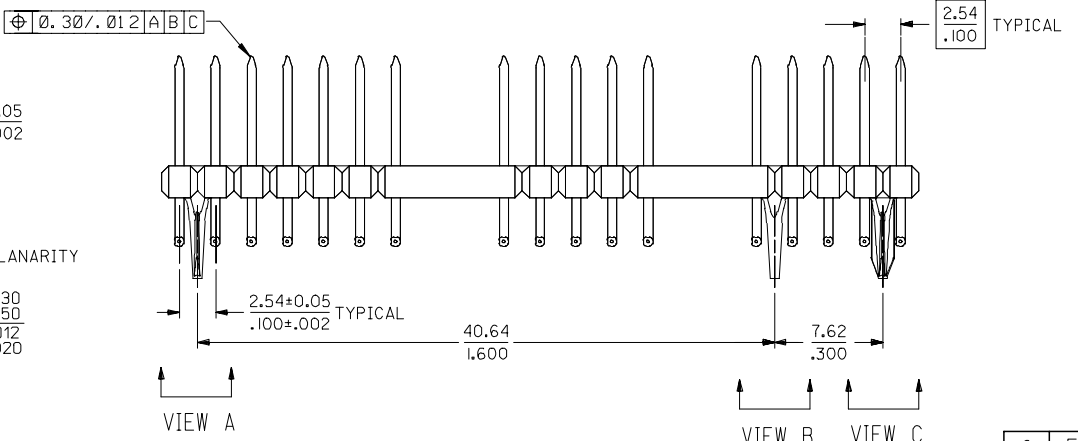
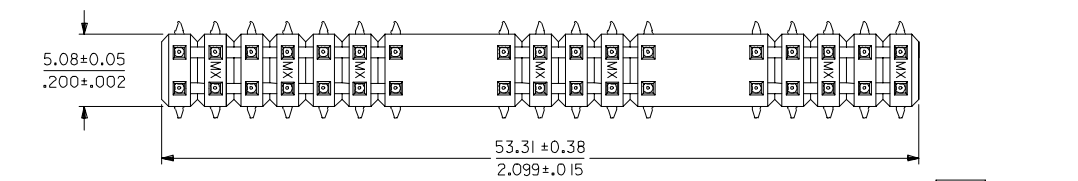

NOTES:

- MATERIALS: INSULATOR: GLASS FILLED LIQUID CRYSTAL POLYMER (LCP).
UL94 V-0, COLOR: BLACK
PIN: BRASS
- PIN PLATING: TIN (Sn) OVER ENTIRE PIN;
THICKNESS=(3.75 MICROMETER)/150 MICROINCH MINIMUM;
NICKEL (Ni) UNDERPLATE OVER ENTIRE PIN.
- PART CONFORMS TO PS-71308.
- PACKAGE PER SPECIFICATION PK-70873-010.
- PEG DATUMS ARE ESTABLISHED AS A VIRTUAL DIAMETER AS DEFINED BY ALL RIBS ON THE PEG.

MOLEX PART NUMBER: 74122-0034
BOSCH PART NUMBER: 6 002 JEO 151 (REVISION 02)

2	E
1	E
SHT	REV

INCR PEG SIZE TOLR FC NO: UCP2007-1145 DRWN:BBARKER 2006/11/09 CHKD:MBARRA 2006/11/10 APPR:SMILLER 2006/11/10 REV	QUALITY SYMBOLS ▽=0 ▽=0	GENERAL TOLERANCES (UNLESS SPECIFIED) mm INCH 4 PLACES ± --- ± --- 3 PLACES ± --- ± .010 2 PLACES ± 0.25 ± .015 1 PLACE ± 0.38 ± --- ANGULAR ±1/2°	DIMENSION STYLE MM/IN DRAWN BY DATE RWHITE 03/07/16 CHECKED BY DATE BBARKER 03/07/16 APPROVED BY DATE SMILLER 03/07/16 MATERIAL NO. 74122-0034	SCALE 4:1 DESIGN UNITS INCH THIRD ANGLE PROJECTION	SALES ASSEMBLY HEADER, DUAL ROW, SMT MOLEX INCORPORATED DOCUMENT NO. SD-74122-001	SHEET NO. 1 OF 2
	DRAFT WHERE APPLICABLE MUST REMAIN WITHIN DIMENSIONS			THIS DRAWING CONTAINS INFORMATION THAT IS PROPRIETARY TO MOLEX INCORPORATED AND SHOULD NOT BE USED WITHOUT WRITTEN PERMISSION		

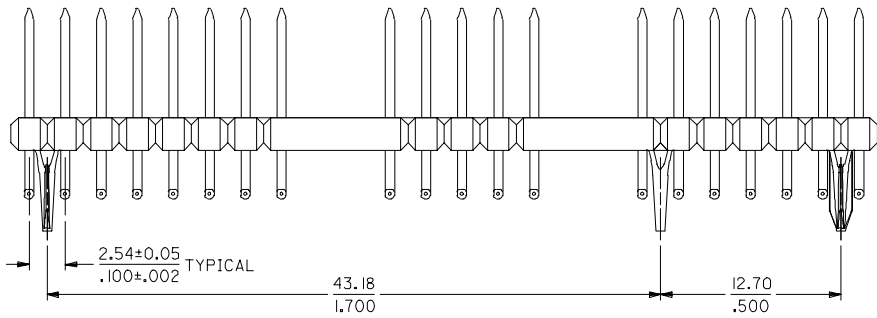
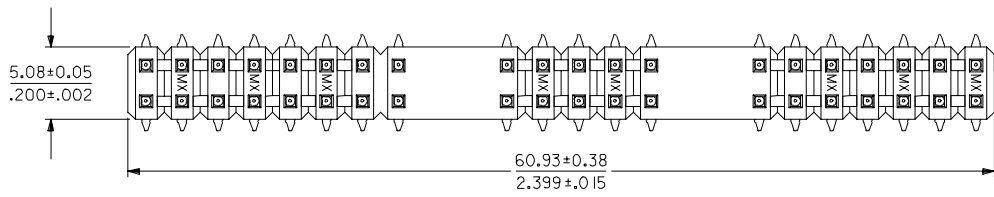
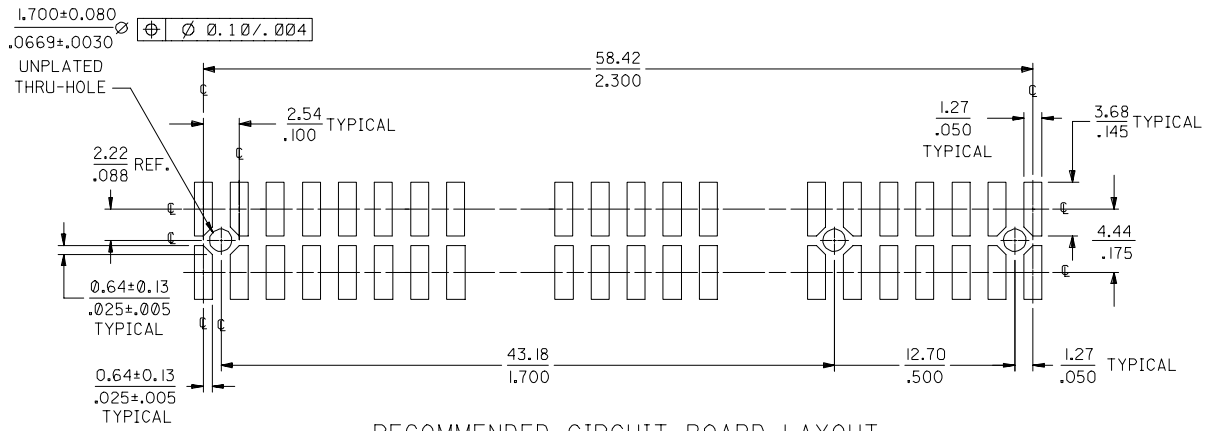

NOTE: DIMENSIONS SHOWN ON SHEET I ALSO APPLY TO THIS PART EXCEPT WHERE OTHERWISE NOTED.

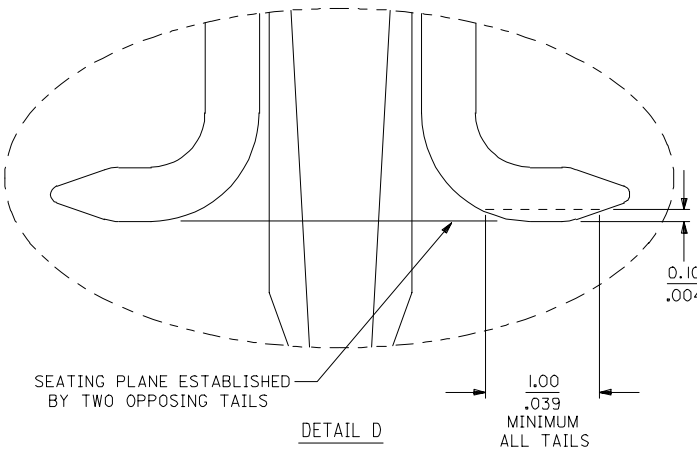

MOLEX PART NUMBER: 74122-0040
 BOSCH PART NUMBER: 6 002 JEO 152 (REVISION 00)

ADD STIFFENER RIBS EC NO: UCP2005-2426 DRAWN BY: DRW:BBARKER 2005/05/19 CHK'D BY: CHK:DJSWART 2005/05/19 APPR: SMILLER 2005/05/19	QUALITY SYMBOLS ▽=0 ▽=0	GENERAL TOLERANCES (UNLESS SPECIFIED) mm INCH 4 PLACES ± --- ± --- 3 PLACES ± --- ± .010 2 PLACES ± 0.25 ± .015 1 PLACE ± 0.38 ± --- ANGULAR ±1/2°	DIMENSION STYLE MM/IN DRAWN BY: RWHITE DATE: 03/07/16 CHECKED BY: BBARKER DATE: 03/07/16 APPROVED BY: SMILLER DATE: 03/07/16	SCALE 4:1	DESIGN UNITS INCH	THIRD ANGLE PROJECTION
	SALES ASSEMBLY HEADER, DUAL ROW, SMT			MOLEX INCORPORATED		
	DRAFT WHERE APPLICABLE MUST REMAIN WITHIN DIMENSIONS			MATERIAL NO. 74122-0040	DOCUMENT NO. SD-74122-001	SHEET NO. 2 OF 2
	THIS DRAWING CONTAINS INFORMATION THAT IS PROPRIETARY TO MOLEX INCORPORATED AND SHOULD NOT BE USED WITHOUT WRITTEN PERMISSION					