

# IL MII BK DI8 DO4-PAC

## Inline Bus Coupler for Mechatrolink With Eight Digital Inputs and Four Digital Outputs

### AUTOMATIONWORX

Data Sheet  
7358\_en\_00

© PHOENIX CONTACT - 08/2006

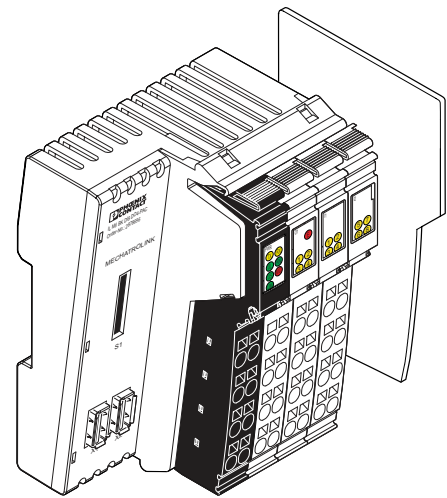

### Description

The IL MII BK DI8 DO8-PAC bus coupler is the interface between the Mechatrolink and the Inline installation system.

Inline terminals can be connected in any location on a Mechatrolink system using the bus coupler. The bus coupler and the Inline terminals form a station with local bus devices. The number of inline terminals allowed is determined by the operating mode (17/32 byte) of the Mechatrolink network, as well as current limitations of the bus coupler.

### Features

- Mechatrolink network connection
- Data transmission rate of 10 Mbps (MII) and 4 Mbps (MI)
- Supports a wide range of Inline terminals
- Can be used in stand-alone mode - with no Inline terminals
- Complies with the Mechatrolink-II Intelligent I/O specification
- Supports "high speed" I/O scanners
- 8 digital inputs
- 4 digital outputs
- Electrical isolation of Mechatrolink interface and logic
- Diagnostic and status LEDs



For additional information on the bus coupler, please refer to the user manual, see "Ordering Data" on page 2.

Make sure you always use the latest documentation.  
It can be downloaded at [www.download.phoenixcontact.com](http://www.download.phoenixcontact.com).  
A conversion table is available on the Internet at  
[www.download.phoenixcontact.com/general/7000\\_en\\_00.pdf](http://www.download.phoenixcontact.com/general/7000_en_00.pdf).

## Ordering Data

### Bus Coupler

Description	Type	Order No.	Pcs./Pck.
Inline bus coupler for Mechatrolink with 8 digital inputs and 4 digital outputs including end plate and connector	IL MII BK DI8 DO4-PAC	2884619	1

### Accessories

Description	Type	Order No.	Pcs./Pck.
Connector set as replacement item	IL BK DIO-PLSET	2878599	1
Extended double signal connector for inputs, 4 signals with 3-wire connection method	IB IL SCN-12-ICP	2727611	10
Extended double signal connector for outputs, 4 signals with 3-wire connection method	IB IL SCN-12-OCP	2727624	10
Encoding profile	IL CP	2742683	100
Zack marker strip to label the terminals	ZB 6 ... see CLIPLINE catalog	1051003	10
DIN EN 50022 DIN rail, 2 meters	NS 35/7,5 PERFORATED	0801733	1
	NS 35/7,5 UNPERFORATED	0801681	1
End clamp	CLIPFIX 35-5	3022276	50

### Additional System Components

Description
Power supply units (INTERFACE catalog) for supplying the bus coupler

### Documentation

Description	Type	Order No.	Pcs./Pck.
User manual: Firmware Functions of the IL MII BK DI8 DO4-PAC Bus Coupler	UM EN IL MII BK DI8 DO4-PAC	2888961	1
User manual: Automation Terminals of the Inline Product Range	IL SYS INST UM E	2698737	1
Application Note: I/O Modules at Bus Couplers	AH IL BK IO LIST	9015358	1

## Technical Data

### General Data

Housing dimensions (width x height x depth)	80 mm x 121 mm x 70 mm
Weight	252 g (including connector)
Degree of protection	IP20 according to IEC 60529
Class of protection	Class 3, according to VDE 0106, IEC 60536
Response time (connected I/Os)	4 ms, typical
Connection method	Spring-cage terminals solid/stranded 0.2 - 1.5 mm <sup>2</sup>
Sum of all I/O data per station	17 byte frame: 12 bytes of input data and 12 bytes of output data 32 byte frame: 27 bytes of input data and 32 bytes of output data (per DIP switch setting)

### System Data

Number of devices per station	63 maximum, but the I/O limits (above) should not be exceeded
Transmission rate on the local bus	500 kbps

### Mechatrolink Interface

Data Rate	4 Mbps or 10 Mbps
Data Size	17 bytes or 32 bytes

### Supply Voltage for $U_L$ , $U_S$ , $U_M$

Recommended cable lengths	30 m, maximum; do not route cables through outdoor areas
Continuation	Through potential routing
Nominal value	24 V DC
Permissible range (according to EN 61131-2)	19.2 V to 30 V (ripple included)
Safety equipment	
Surge voltage, polarity reversal	Yes, suppressor diode parallel to supply voltage



#### Provide an external fuse for the 24 V area

This 24 V area must be externally protected. The power supply unit must be able to supply 4 times the nominal current of the external fuse, to ensure that it trips in the event of an error.



The bus coupler supply  $U_L$  (24 V) generates the analog supply  $U_{ANA}$  (24 V) and the communications power  $U_L$  (7.5 V) for the Inline station.

### Power Consumption

Current consumption from $U_{LOGIC}$ (7.5 V)	0.09 A with no inline terminals / 0.9 A, maximum
--	--



Maximum bus coupler current for supplying I/O terminal logic = 0.8 A maximum.

Current consumption from $U_S$ (24 V)	8 A, maximum
Current consumption from $U_M$ (24 V)	8 A, maximum
Current consumption from $U_{ANALOG}$ (24 V)	0.5 A, maximum
Power dissipation	2.16 W, typical / 4 W maximum

### Digital Outputs

Number	4
Connection method for actuators	2 and 3-wire technology
Nominal output voltage $U_{OUT}$	24 V DC
Differential voltage at $I_{nom}$	< 1 V
Nominal current $I_{nom}$ per channel	0.5 A
Total current	2 A
Nominal load	
Ohmic	12 W
Lamp	12 W
Inductive	12 VA (1.2 H)
Switching frequency with nominal inductive load	0.5 Hz (1.2 H), maximum
Response time	1.2 ms, typical
Overload response	Auto restart
Response with inductive overload	Output may be damaged
Reverse voltage protection against short pulses	Protected against reverse voltages
Resistance to permanently applied reverse voltages	Protected against reverse voltages, permissible current 2 A, maximum
Response upon power down	The output follows the supply voltage without delay.
Limitation of the voltage induced on circuit interruption	-30.0 V, approximately
Safety equipment	Short circuit; overload
Type of safety equipment	Integrated free running circuit in the output chip
Maximum output current when switched off	10 $\mu$ A
Error message to the higher-level control system	a short circuit causes a Peripheral Warning indication to the higher-level control system



When not loaded, a voltage can be measured even at an output that is not set.

### Digital Inputs

Number	8
Connection method for sensors	2 and 3-wire technology
Input design	According to EN 61131-2 Type 1
Definition of switching thresholds	
Maximum low-level voltage	$U_{Lmax} < 5$ V
Minimum high-level voltage	$U_{Hmin} > 15$ V
Common potentials	Sensor supply $U_S$ , ground
Nominal input voltage $U_{IN}$	24 V DC
Permissible range	-3 V < $U_{IN}$ < +30 V DC
Nominal input current for $U_{IN}$	3 mA, typical
Current flow	Limited to a 3 mA, maximum
Delay time	1.2 ms, typical
Permissible cable length to the sensor	100 m
Use of AC sensors	AC sensors in the voltage range < $U_{IN}$ are limited in application
Safety equipment	Polarity reversal
Type of safety equipment	Serial diode for polarity reversal protection
Error message to the higher-level control system	Sensor supply not present

### Ambient Conditions

Ambient temperature (operation)	0°C to +60°C
Ambient temperature (storage)	-25°C to +85°C
Humidity (operation/storage/transport)	95%, no condensation



In the range from -25°C to +60°C appropriate measures against increased humidity (> 85%) must be taken.



For a short period, slight condensation may appear on the outside of the housing if, for example, the terminal is brought into a closed room from a vehicle.

Air pressure (operation/storage/transport)	70 kPa to 106 kPa (up to 3000 m above sea level)
--	--

### Mechanical Requirements

Vibration test; sinusoidal vibrations according to IEC 60068-2-6; EN 60068-2-6	5g load, 2 hours in each space direction
Shock test according to IEC 60068-2-27; EN 60068-2-27	25g load for 11 ms, half sinusoidal wave, three shocks in each space direction and orientation

### Conformance With EMC Directive 89/336/EEC

#### Noise Immunity Test According to EN 61000-6-2

Electrostatic discharge (ESD)	EN 61000-4-2/ IEC 61000-4-2	Criterion B 6 kV contact discharge 8 kV air discharge
Electromagnetic fields	EN 61000-4-3 IEC 61000-4-3	Criterion A Field strength: 10 V/m
Fast transients (burst)	EN 61000-4-4/ IEC 61000-4-4	Criterion A All interfaces: 1 kV Criterion B All interfaces: 2 kV
Surge voltage	EN 61000-4-5/ IEC 61000-4-5	Criterion B DC supply lines: 0.5 kV / 1 kV (symmetrical / asymmetrical) Fieldbus cable shielding 1 kV
Conducted interference	EN 61000-4-6 IEC 61000-4-6	Criterion A Test voltage 10 V

#### Noise Emission Test According to EN 61000-6-4

Noise emission of housing	EN 55011	Class A
---------------------------	----------	---------

### Approvals

Information on current approvals can be found on the Internet at [www.phoenixcontact.com](http://www.phoenixcontact.com).

Local Diagnostic and Status Indicators

Mechatrolink

PWR

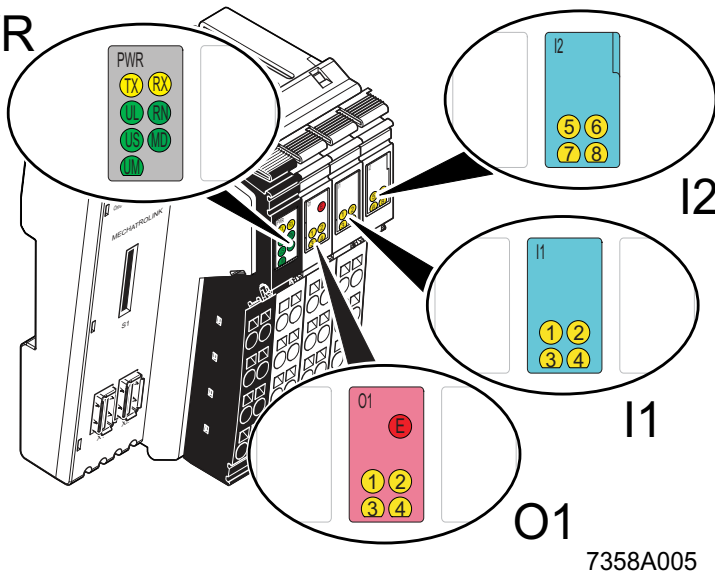

7358A005

Figure 1 Indicators on the bus coupler

LED	Color	Meaning	State	Description of the LED States
UL	Green	U <sub>Logic</sub>	ON	24 V bus coupler power supply / 7.5 communications power present
			OFF	24 V bus coupler power supply / 7.5 communications power not present
US	Green	U <sub>Segment</sub>	ON	24 V segment circuit supply present
			OFF	24 V segment circuit supply not present
UM	Green	U <sub>Main</sub>	ON	24 V I/O supply present
			OFF	24 V I/O supply not present
TX	Yellow	Transmit data	Continuous flashing	Mechatrolink protocol chip is actively transmitting.
			OFF	Mechatrolink protocol chip is not actively transmitting.
RX	Yellow	Receive Data	Continuous flashing	Mechatrolink protocol chip is actively receiving.
			OFF	Mechatrolink protocol chip is not actively receiving.

LED	Color	Meaning	State	Description of the LED States
RN	Green/ red	Local bus status	OFF	Stand-alone mode Onboard I/Os are used. No other Inline terminals connected.
			Green ON	Local bus communication is active.
			Continuous flashing, green	Initialization/configuration phase
			1 green flash	Peripheral Warning: An output may be shorted.
			2 green flashes	I/O Size Warning: The amount of Inline local bus data exceeds the frame-size DIP switch setting. Communication continues. Only frame-size bytes of I/O data are accessible.
			3 green flashes	Operation with error data
			Red ON	Module Connection Alarm: Local bus is stopped
			2 red flashes	Module Change Alarm On Startup: Inline configuration is incorrect on startup.
			2 red flashes, then 1 green flash	Module Change Alarm On Startup: Inline configuration error when starting the bus coupler: Onboard I/Os are operated with error data.
			2 red flashes, then 2 green flashes	Module Change Alarm On Startup: Inline configuration error when starting the bus coupler: Onboard I/Os and Inline I/Os are operated with error data.
			3 red flashes	Module Change Alarm While Running: Inline configuration becomes incorrect while running (Inline terminal failed).
			3 red flashes, then 1 green flashes	Module Change Alarm While Running: Inline configuration becomes incorrect while running (Inline terminal failed). Onboard I/O running error data.
3 red flashes, then 2 green flashes	Module Change Alarm While Running: Inline configuration becomes incorrect while running (Inline terminal failed). Onboard and Inline I/O running error data.			

LED	Color	Meaning	State	Description of the LED States
<b>MD</b>	Green/ red	Network sta- tus	OFF	No voltage present.
			Green ON	Phase 2: Network connected. Asynchronous communication activated.
			Continuous flashing, green	Phase 1: Initializing or bus coupler waiting for master to connect.
			3 green Flashes	The master has tried to set a transmission cycle time that is not supported.
			Red ON	Communication Alarm: Loss of communication with the master. All outputs are set according to DIP switch 9.
			Continuous flashing, red	Power-Loss Alarm: One of the power supplies has failed. The outputs are set according to the current Recover Mode, see note below.
			2 red flashes	Communication Alarm: Mechatrolink Communication Alarm with frame errors occurring at the time of the alarm. All outputs are set according to DIP switch 9.
			3 red flashes	Initialization of the Mechatrolink protocol chip has failed.
<b>E</b>	Red	<b>Error</b>	ON	Peripheral Warning for the onboard outputs
			OFF	Peripheral Warning not present.
<b>1-4</b>	Yellow	<b>O1</b>	ON	Outputs active
			OFF	Outputs not active
<b>1-8</b>	Yellow	<b>I1, I2</b>	ON	Inputs active
			OFF	Inputs not active



If the US power supply fails and the fault recover mode is such that outputs are to be set with error data, the LEDs of the output terminals may be on while the actual output may be off.





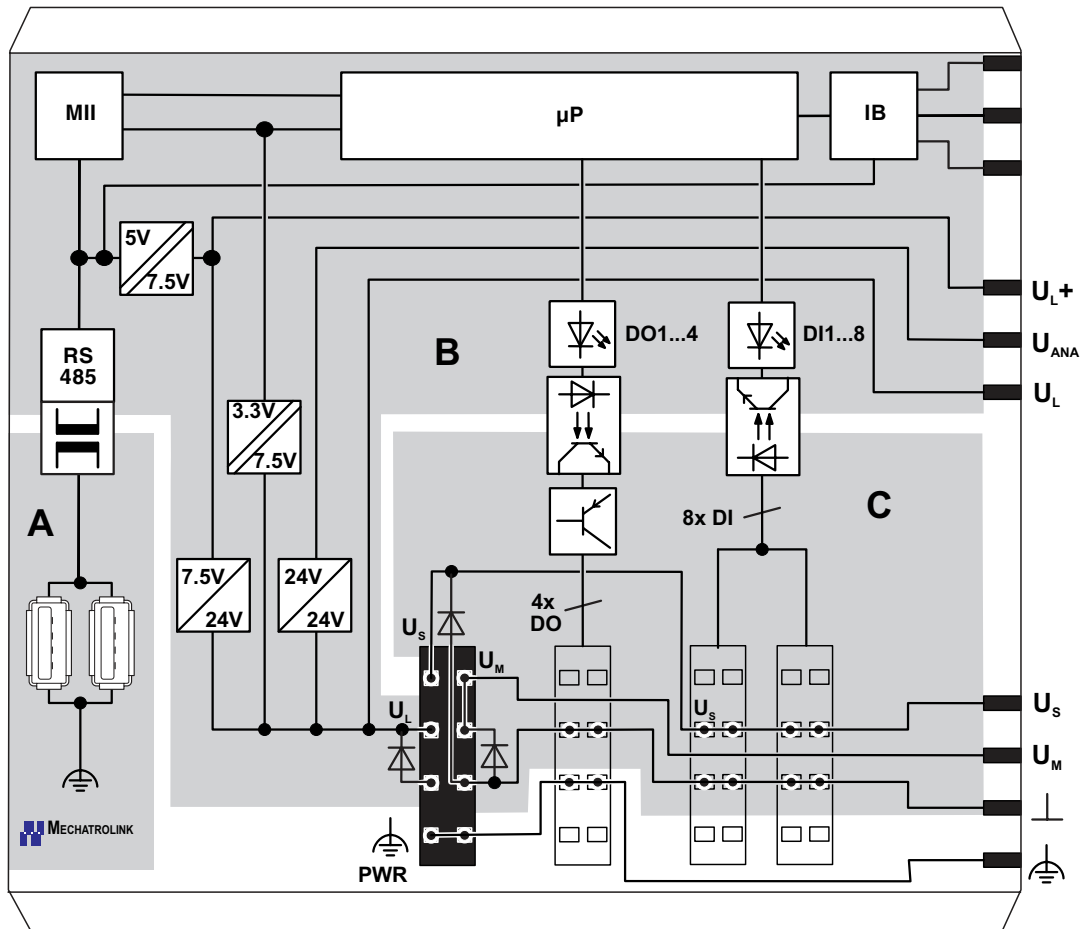



### Circuit Diagram

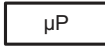

7358A003

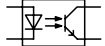
Figure 1 Circuit diagram of the bus coupler

Key:

- |   |   |  |
|---|---|--|
|  | Protocol chip                               | The gray areas in the circuit diagram represent the electrically isolated areas: |
|  | Microprocessor                              |  |
|  | Protocol chip                               | A: Mechatrolink interface  |
|  | Optocoupler                                 | B: Logic   |
|  | Power supply unit with electrical isolation | C: I/O   |
|  | RS-485 interface                            |  |
|  | Transformer                                 |  |
|  | PNP transistor                              |  |

## Connecting the Mechatrolink Network

Connect the Mechatrolink network to X1 and X2.

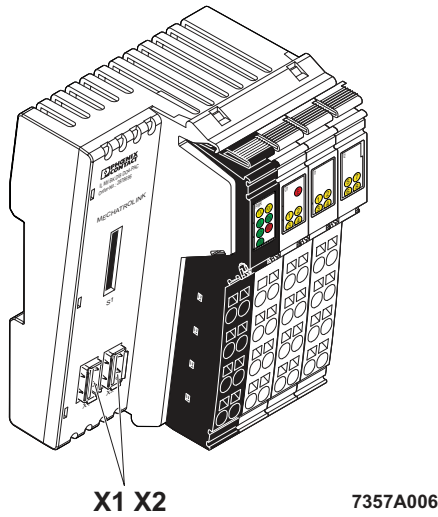

Figure 2 Connecting the Mechatrolink network

## Pin Assignments of the Mechatrolink Connectors X1 and X2

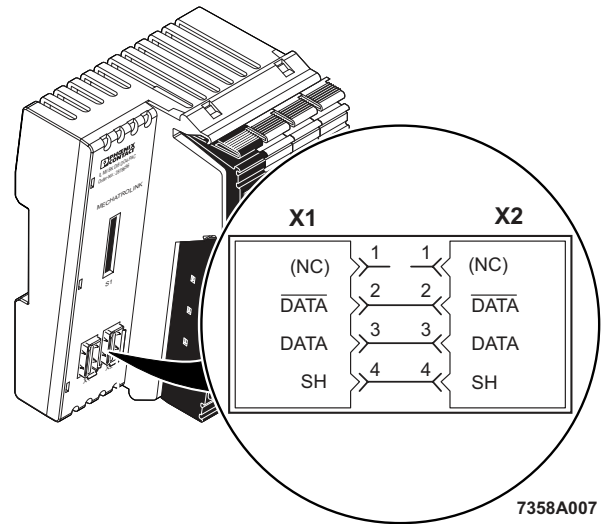

Figure 3 Pin assignments of the mechatrolink connectors



On the last bus coupler in the Mechatrolink network a termination resistor must be inserted on the Mechatrolink interface.

Pin	Assignment
1	Not connected
2	$\overline{\text{DATA}}$
3	DATA
4	Shield

**Example Topology**

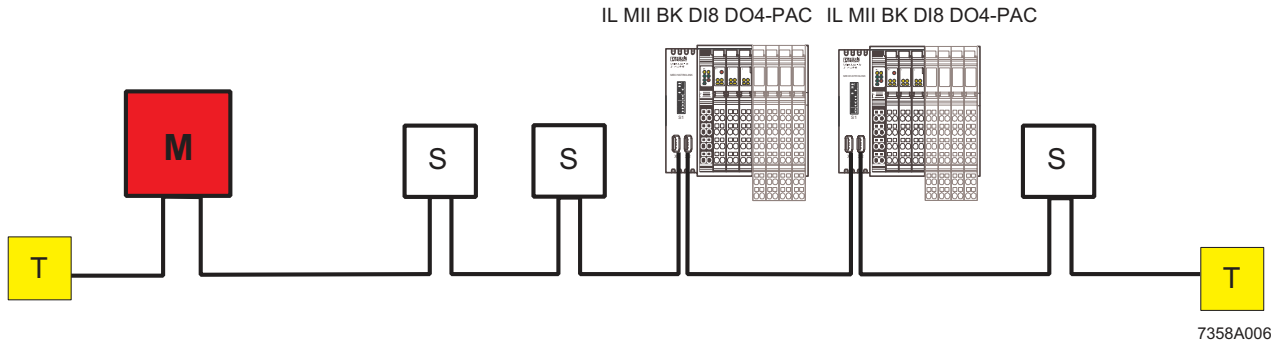

Figure 4 Example Topology

Notes:

- M: Master, a network control station. Each network must have at least one master.
- S: Slave Device, a device such as a IL MII BK DI8 DO4-PAC or servo amplifier. The master controls the slave devices though the network. Multiple IL MII BK DI8 DO4-PAC bus couplers may be located on the same network.
- T: Terminating Resistor (130 Ω located at both ends of the bus)

**Configuration Using the DIP Switches**

The DIP switches are on the left side of the bus coupler. The following functions can be set using the DIP switches. These functions only take effect when the bus coupler is powered-on.

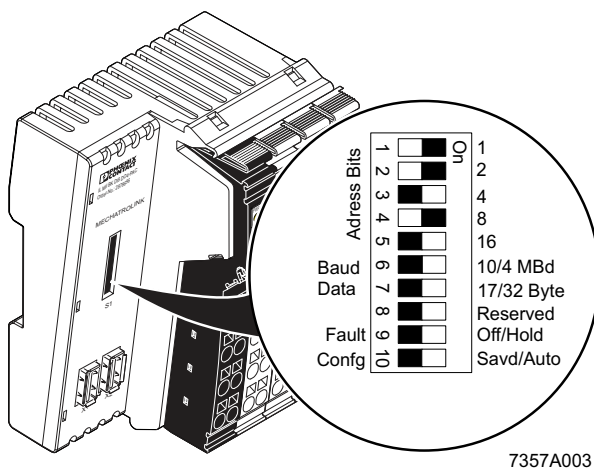

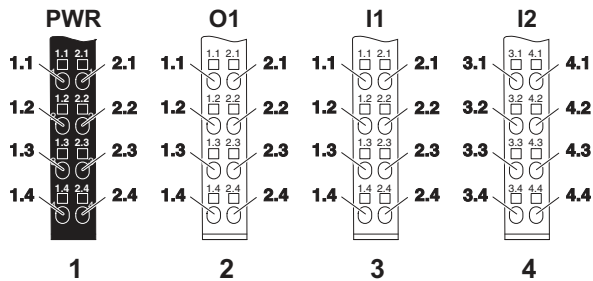

Figure 5 DIP switches

Switch	Meaning
1 to 5	<p><b>Slave address:</b> Switches 1 to 5 represent a binary number. Switch 1 is the least significant bit. The switch setting is added to 60<sub>hex</sub> in order to create the slave's Mechatrolink network address.</p>
6	<p><b>Bus speed:</b> Off = 10 Mbps (MII), On = 4 Mbps (MI)</p>
7	<p><b>Frame size:</b> Off = 17 bytes (supported in both bus speeds) On = 32 bytes (only supported by bus speed = 10 Mbps) This switch is ignored when switch 6 is on.</p>
8	Reserved
9	<p><b>Communication Loss Output Action:</b> When communication with the master is lost, or the master sends a DISCONNECT command. Off = outputs are set to 0. On = outputs retain last value.</p>
10	<p><b>Automatic configuration:</b> Off = Use the Inline bus configuration stored last. An alarm is indicated if the current bus configuration is not the same as the previous configuration. On = Auto configure the local bus and save it in non-volatile memory. Select Stand-alone mode, if no Inline terminals are connected to the bus coupler. Proceed as follows:</p> <ul style="list-style-type: none"> <li>• Disconnect the voltage from the bus coupler.</li> <li>• Add/remove the Inline terminals, if necessary.</li> <li>• Set switch 10 on.</li> <li>• Apply voltage to the bus coupler.</li> <li>• Set switch 10 off.</li> </ul> <p> After automatic configuration switch 10 should be switched off.</p>
1 to 10	<p><b>Factory Defaults:</b> If voltage is connected to the bus coupler and all the switches are on, all non-volatile memory parameters (except for serial number) will return to their factory default values on the next power-up. The FAC_DEFAULTS bit of the IL_CTRL byte can also be used for this purpose. Proceed as follows:</p> <ul style="list-style-type: none"> <li>• Disconnect the voltage from the bus coupler.</li> <li>• Set all switches on.</li> <li>• Apply voltage to the bus coupler. The RN LED and MD LED are red to indicate that the bus coupler is ready to be reset.</li> <li>• Disconnect the voltage from the bus coupler.</li> <li>• Set switch 10 on and set all the other switches to the relevant settings.</li> <li>• Apply voltage to the bus coupler. It will start up with factory default values.</li> <li>• Set switch 10 off.</li> </ul> <p> After automatic configuration switch 10 should be switched off.</p>

### Terminal Point Assignment



71820010

Figure 6 Terminal point assignment for the connectors

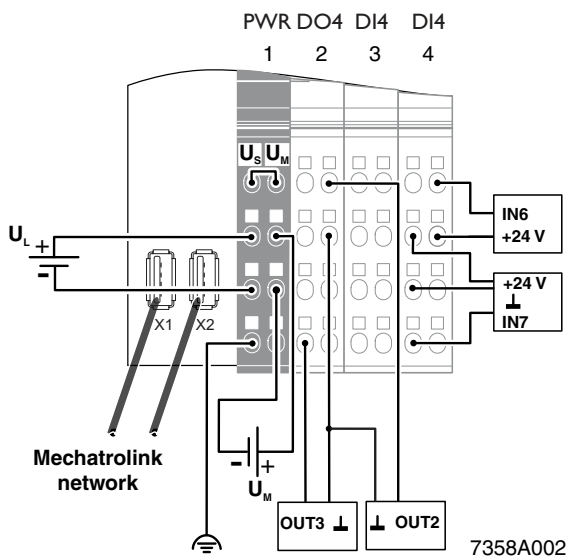

7358A002

Figure 7 Connection example

Connect the bus coupler according to Figure 7.

### Terminal point assignment of the power connector (1)

Terminal Points	Assignment	Terminal Points	Assignment
1.1	$U_S$	2.1	$U_M$
1.2	$U_L$	2.2	$U_M$
1.3	GND $U_L$	2.3	GND $U_M, U_S$
1.4	Functional earth ground (FE)	2.4	Functional earth ground (FE)

### Terminal point assignment of the output connector (2)

Terminal Points	Assignment	Terminal Points	Assignment
1.1	OUT1	2.1	OUT2
1.2	PGND	2.2	PGND
1.3	FE	2.3	FE
1.4	OUT3	2.4	OUT4

### Terminal point assignment of the input connector (3)

Terminal Points	Assignment	Terminal Points	Assignment
1.1	IN1	2.1	IN2
1.2	$U_S$	2.2	$U_S$
1.3	PGND	2.3	PGND
1.4	IN3	2.4	IN4

### Terminal point assignment of the input connector (4)

Terminal Points	Assignment	Terminal Points	Assignment
3.1	IN5	4.1	IN6
3.2	$U_S$	4.2	$U_S$
3.3	PGND	4.3	PGND
3.4	IN7	4.4	IN8

## Process Data

### Assignment of Terminal Points to the OUT Process Data (Slot 2)

(Byte.Bit) view	Byte	Byte 4							
	Bit	7	6	5	4	3	2	1	0
Module	Slot	2							
	Terminal point (signal)	2.4	1.4	2.1	1.1	not used			
	Terminal point (GND)	2.2	1.2	2.2	1.2				
	Terminal point (FE connection)	2.3	1.3	2.3	1.3				
Status indicator	Slot	2							
	LED	4	3	2	1	-	-	-	-

### Assignment of Terminal Points to the IN Process Data (Slots 3 and 4)

(Byte.bit) view	Byte	Byte 4							
	Bit	7	6	5	4	3	2	1	0
Module	Slot	4				3			
	Terminal point (signal)	4.4	3.4	4.1	3.1	2.4	1.4	2.1	1.1
	Terminal point (24 V)	4.2	3.2	4.2	3.2	2.2	1.2	2.2	1.2
	Terminal point (GND)	4.3	3.3	4.3	3.3	2.3	1.3	2.3	1.3
Status indicator	Slot	4				3			
	LED	8	7	6	5	4	3	2	1



Further additional information please refer to the user manual, chapter "Mappings Reference".