

# CBT-140 WhiteLEDs



## Table of Contents

Technology Overview .....2

Test Specifications .....2

Binning Structure .....3

Chromaticity Bins .....4

Product Shipping & Labeling Information.....6

Electrical Characteristics .....7

Lifetime & Lumen Maintenance.....9

Radiation Patterns .....9

Thermal Resistance ..... 10

Mechanical Dimensions .. 11

Ordering Information .... 12

## Features:

- Extremely high optical output from a 14 mm<sup>2</sup> circular source: Up to 3,700 white lumens
- Round emitting aperture provides most efficient match to circular optical systems and narrow beam projectors
- Unencapsulated package preserves small etendue facilitating narrow beam optical system design
- Chip on board package assures straightforward system assembly with the best possible thermal performance for high power devices.
- Integrated thermistor enables consistent temperature monitoring during operation for high system reliability
- High thermal conductivity package - junction to heat sink thermal resistance less than 0.6°C/W
- Variable drive current: 1 A to 28A for white
- High CRI in Tungsten and Daylight color temperatures for natural lighting
- Environmentally friendly: RoHS compliant

## Applications

- Architectural and Entertainment Lighting
- Fiber-coupled Illumination
- Medical Lighting
- Machine Vision
- Microscopy
- Spot Lighting

## Technology Overview

Luminus Big Chip LEDs™ benefit from a suite of innovations in the fields of chip technology, packaging and thermal management. These breakthroughs allow illumination engineers and designers to achieve solutions that are high brightness and high efficiency.

### Photonic Lattice Technology

Luminus' photonic lattice technology enables large area LED chips with uniform brightness over the entire LED chip surface. The optical power and brightness produced by these large monolithic chips enable solutions which replace arc and halogen lamps where arrays of traditional high power LEDs cannot.

### Packaging Technology

Thermal management is critical in high power LED applications. With a thermal resistance from junction to heat sink of 0.59° C/W, Luminus CBT-140 LEDs have the lowest thermal resistance of any LED on the market. This allows the LED to be driven at higher current densities while maintaining a low junction temperature, thereby resulting in brighter solutions and longer lifetimes.

### Reliability

Designed from the ground up, Luminus Big Chip LEDs are one of the most reliable light sources in the world today. Big Chip LEDs

have passed a rigorous suite of environmental and mechanical stress tests, including mechanical shock, vibration, temperature cycling and humidity, and have been fully qualified for use in extreme high power and high current applications. With very low failure rates and median lifetimes that typically exceed 60,000 hours, Luminus Big Chip LEDs are ready for even the most demanding applications.

### Environmental Benefits

Luminus LEDs help reduce power consumption and the amount of hazardous waste entering the environment. All Big Chip LED products manufactured by Luminus are RoHS compliant and free of hazardous materials, including lead and mercury.

## Understanding Big Chip LED Test Specifications

Every Luminus LED is fully tested to ensure that it meets the high quality standards expected from Luminus' products.

### Testing Temperature

Luminus core board products are typically measured in such a way that the characteristics reported agree with how the devices will actually perform when incorporated into a system. This measurement is accomplished by mounting the devices on a 40°C heat sink and allowing the device to reach thermal equilibrium while fully powered. Only after the device reaches equilibrium are the measurements taken. This method of measurement ensures that Luminus Big Chip LEDs perform in the field just as they are specified.

Expected flux values in real world operation can be extrapolated based on the information contained within this product data sheet.

### Multiple Operating Points (14.0 A, 21.0 A, 28.0 A)

The tables on the following pages provide typical optical and electrical characteristics. Since the LEDs can be operated over a wide range of drive conditions (currents from 1A to 28.0A, and duty cycles from <1% to 100%), multiple drive conditions are listed.

CBT-140 White LEDs are production tested at 21.0 A. The values shown at other current conditions such as 14.0A and 28.0 are for additional reference at other possible drive conditions.

### CBT-140 White Binning Structure

CBT-140 white LEDs are tested for luminous flux and chromaticity at a drive current of 21.0 A (1.5 A/mm<sup>2</sup>) and placed into one of the following luminous flux (FF) and chromaticity (WW) bins:

#### Flux Bins

Color	Flux Bin (FF)	Minimum Flux (lm) at 21.0A	Maximum Flux (lm) at 21.0A
WCS Cool White Standard CRI (typ. 75)	TA	3,200	3,440
	TB	3,440	3,680
	UA	3,680	3,955
WDH Daylight High CRI (typ. 90)	QB	2,260	2,420
	RA	2,420	2,600
	RB	2,600	2,780
WTH Tungsten White High CRI (typ. 95)	PB	1,965	2,100
	QA	2,100	2,260

\*Note: Luminus maintains a +/- 6% tolerance on flux measurements.

#### Chromaticity Bins

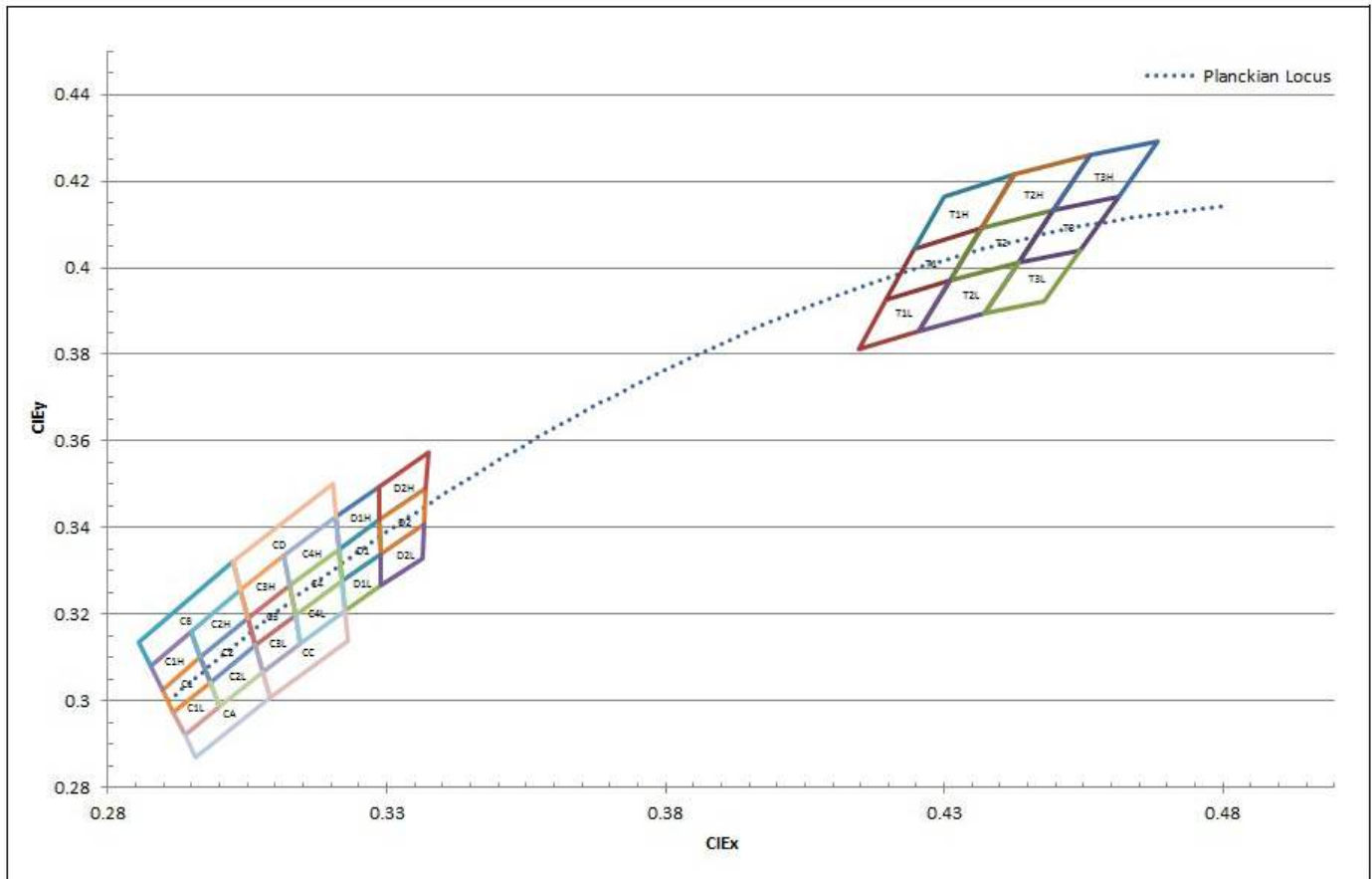

**CBT-140 White Chromaticity Bins**

The following tables describe the four chromaticity points that bound each chromaticity bin. Chromaticity bins are grouped together based on the color temperature.

Daylight Chromaticity Bins		
Bin Code(WW)	CIE <sub>x</sub>	CIE <sub>y</sub>
D1	0.321	0.327
	0.321	0.335
	0.328	0.341
	0.328	0.334
D2	0.328	0.334
	0.328	0.341
	0.337	0.348
	0.336	0.340
D1H	0.321	0.335
	0.320	0.342
	0.328	0.349
	0.328	0.341
D2H	0.328	0.341
	0.328	0.349
	0.337	0.357
	0.337	0.348
D1L	0.321	0.327
	0.322	0.320
	0.328	0.326
	0.328	0.334
D2L	0.328	0.334
	0.328	0.326
	0.336	0.333
	0.336	0.340

Cool White Chromaticity Bins		
Bin Code(WW)	CIE <sub>x</sub>	CIE <sub>y</sub>
C1	0.291	0.297
	0.289	0.302
	0.296	0.310
	0.298	0.304
C2	0.298	0.304
	0.296	0.310
	0.305	0.319
	0.306	0.312
C3	0.306	0.312
	0.305	0.319
	0.312	0.326
	0.313	0.319
C4	0.313	0.319
	0.312	0.326
	0.321	0.335
	0.321	0.327
C1H	0.289	0.302
	0.287	0.307
	0.294	0.315
	0.296	0.310
C2H	0.296	0.310
	0.294	0.315
	0.303	0.325
	0.305	0.319
C3H	0.305	0.319
	0.303	0.325
	0.311	0.333
	0.312	0.326
C4H	0.312	0.326
	0.311	0.333
	0.320	0.342
	0.321	0.335

**CBT-140 White Chromaticity Bins**

The following tables describe the four chromaticity points that bound each chromaticity bin. Chromaticity bins are grouped together based on the color temperature.

Cool White Chromaticity Bins		
Bin Code(WW)	CIE <sub>x</sub>	CIE <sub>y</sub>
C1L	0.291	0.297
	0.293	0.292
	0.299	0.298
	0.298	0.304
C2L	0.298	0.304
	0.299	0.298
	0.307	0.306
	0.306	0.312
C3L	0.306	0.312
	0.307	0.306
	0.314	0.313
	0.313	0.319
C4L	0.313	0.319
	0.314	0.313
	0.322	0.320
	0.321	0.327
CA	0.293	0.292
	0.295	0.287
	0.309	0.300
	0.307	0.306
CB	0.287	0.307
	0.285	0.313
	0.302	0.332
	0.303	0.325
CC	0.307	0.306
	0.309	0.300
	0.322	0.313
	0.322	0.320
CD	0.303	0.325
	0.302	0.332
	0.320	0.350
	0.320	0.342

Tungsten White Chromaticity Bins		
Bin Code(WW)	CIE <sub>x</sub>	CIE <sub>y</sub>
T1	0.419	0.392
	0.424	0.404
	0.436	0.409
	0.430	0.397
T2	0.430	0.397
	0.436	0.409
	0.449	0.413
	0.443	0.401
T3	0.443	0.401
	0.449	0.413
	0.461	0.416
	0.454	0.404
T1H	0.424	0.404
	0.429	0.416
	0.442	0.421
	0.436	0.409
T2H	0.436	0.409
	0.442	0.421
	0.456	0.425
	0.449	0.413
T3H	0.449	0.413
	0.456	0.425
	0.468	0.429
	0.461	0.416
T1L	0.419	0.392
	0.414	0.381
	0.425	0.385
	0.430	0.397
T2L	0.430	0.397
	0.425	0.385
	0.437	0.389
	0.443	0.401
T3L	0.443	0.401
	0.437	0.389
	0.447	0.392
	0.454	0.404

## Product Shipping & Labeling Information

All CBT-140 products are packaged and labeled with their respective bin as outlined in the tables and charts on pages 3, 4, & 5. When shipped, each package will only contain one bin. The part number designation is as follows:

### CBT-140 White

**CBT** — **140** — **WNX** — **C15** — **FF** — **WW**

Product Family	Chip Area	Color	Package Configuration	Flux Bin	Chromaticity Bin
CBT: Chip on Board (window)	140: 14.0 mm <sup>2</sup>	Color & CRI See Note 1 below	Internal Code	See page 3 for bins	See page 4-5 for bins

Note 1: WNX nomenclature corresponds to the following:

W = White

N = color, where:

C corresponds to Cool White, D corresponds to Daylight White, and T corresponds to Tungsten White

X = color rendering index, where:

S (Standard) corresponds to a typical CRI of 75

H (high) corresponds to a typical CRI of 95

#### Example 1:

The part label CBT-140-WDH-C15-RA-D4 refers to a Daylight high CRI white, CBT-140 emitter, with a flux range from 2,420 to 2,600 lumens and a chromaticity value within the box defined by the four points (0.204, 0.477), (0.201, 0.481), (0.204, 0.486), (0.207, 0.482).

**CBT-140 White Electrical Characteristics<sup>1</sup>**

**Optical and Electrical Characteristics (T<sub>j</sub> = 90 °C)**

Drive Condition <sup>2</sup>		14.0 A Continuous	21.0 A Continuous	28.0 A Continuous	
Parameter	Symbol	Typical Values at Indicated Current <sup>3</sup>	Values at Test Currents	Typical Values at Indicated Current <sup>3</sup>	Unit
Current Density	j	1.0	1.5	2.0	A/mm <sup>2</sup>
Forward Voltage	V <sub>F,min</sub>		3.4		V
	V <sub>F,typ</sub>	3.3	3.6	3.8	V
	V <sub>F,max</sub>		3.8		V

**Common Characteristics**

Parameter	Symbol	Typical Values	Unit
Emitting Area		14.0	mm <sup>2</sup>
Color Rendering Index (Typical)	Cool White	CRI	75
	Daylight White	CRI	90
	Tungsten White	CRI	95
Dynamic Resistance	Ω <sub>dyn</sub>	0.050	Ω
Forward Voltage Temperature Coefficient <sup>5</sup>		-5.47	mV/°C

**Absolute Maximum Ratings**

Parameter	Symbol	Values	Unit
Maximum Current <sup>6</sup>		28.0	A
Maximum Junction Temperature <sup>7</sup>	T <sub>j,max</sub>	150	°C
Storage Temperature Range		-40/+100	°C

Note 1: All ratings are based on operation with a constant junction temperature T<sub>j</sub> = 90°C.

Note 2: Listed drive conditions are typical for common applications. CBT-140 white devices can be driven at currents ranging from 1A to 28A and at duty cycles ranging from 1% to 100%. Drive current and duty cycle should be adjusted as necessary to maintain the junction temperature desired to meet application lifetime requirements.

Note 3: Unless otherwise noted, values listed are typical.

Note 4: CCT value based off of CIE measurement. CIE measurement uncertainty for white devices is estimated to be +/- 0.005.

Note 5: Forward voltage temperature coefficient at current density of 1.5 A/mm<sup>2</sup>. Contact Luminus for value at other drive conditions.

Note 6: CBT-140 White LEDs are designed for operation to an absolute maximum forward drive current density of 2.0 A/mm<sup>2</sup>. Product lifetime data is specified at recommended forward drive currents. Sustained operation at absolute maximum currents will result in a reduction of device lifetime compared to recommended forward drive currents. Actual device lifetimes will also depend on junction temperature. Refer to the lifetime derating curves for further information. In pulsed operation, rise time from 10-90% of forward current should be larger than 0.5 microseconds.

Note 7: Lifetime dependent on LED junction temperature. Input power and thermal system must be properly managed to ensure lifetime. See charts on pg 9 for further information.

Note 8: Special design considerations must be observed for operation under 1 A. Please contact Luminus for further information.

Note 9: Caution must be taken not to stare at the light emitted from these LEDs. Under special circumstances, the high intensity could damage the eye.

**CBT-140 White Optical & Electrical Characteristics**

**Relative Output Flux vs. Forward Current**

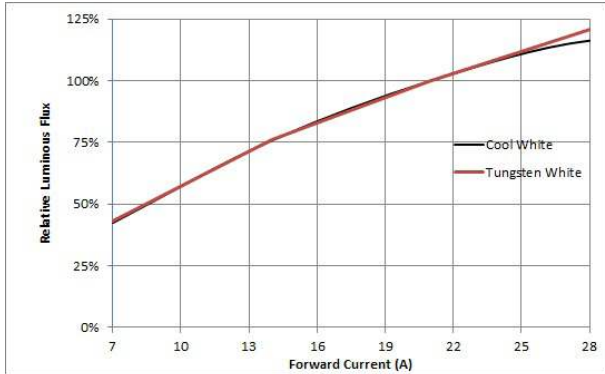

**Forward Current vs. Forward Voltage**

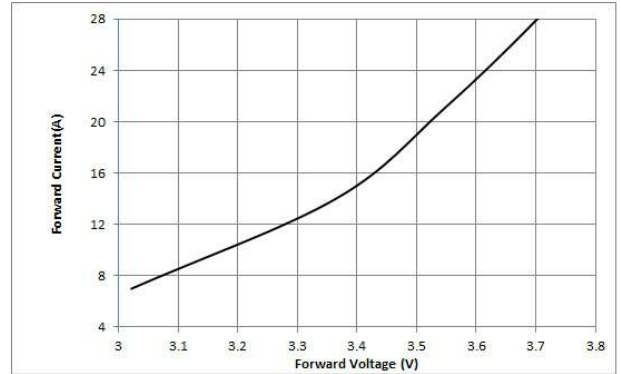

**Relative Output Flux vs. Junction Temp**

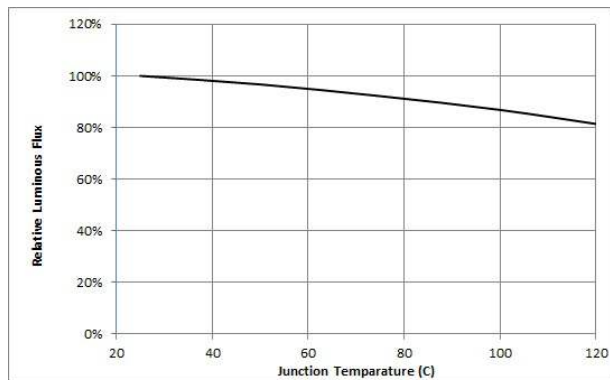

**Change in Voltage vs. Junction Temp**

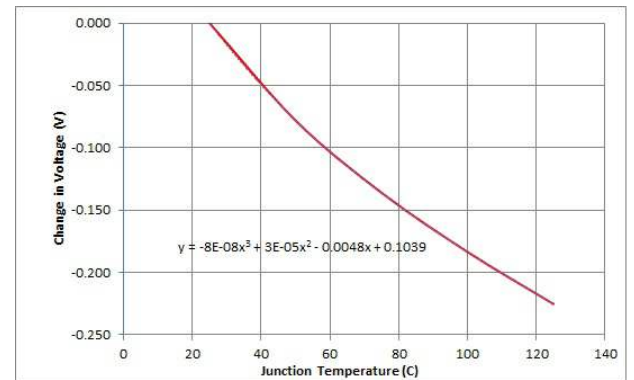

**Typical Spectrum<sup>1</sup>**

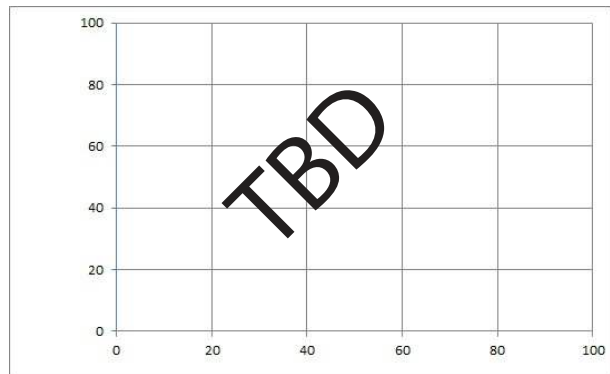

**Current Derating Curve**

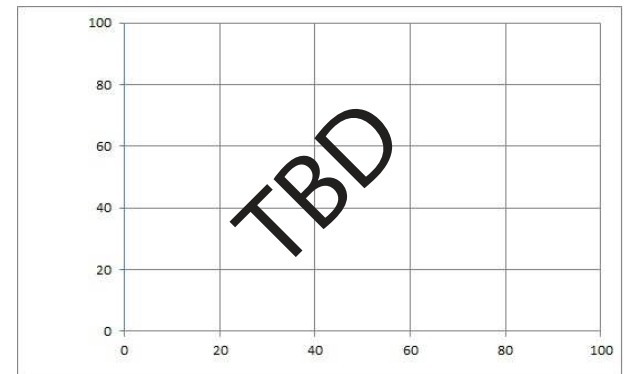

Note 1: Typical spectrum at current density of 1.5 A/mm<sup>2</sup> in continuous operation.



**CBT-140 White Optical & Electrical Characteristics**

**Mean Lifetime<sup>2</sup>**

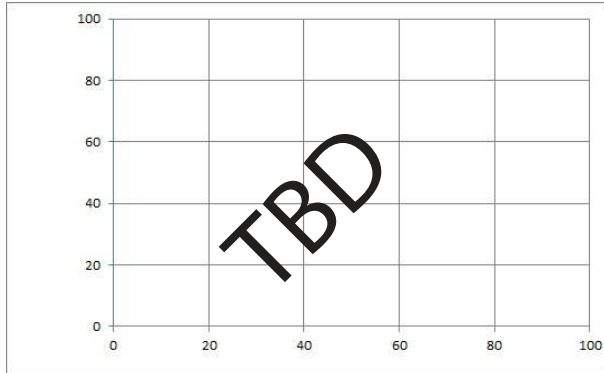

**Lumen Maintenance vs. Time<sup>3</sup>**

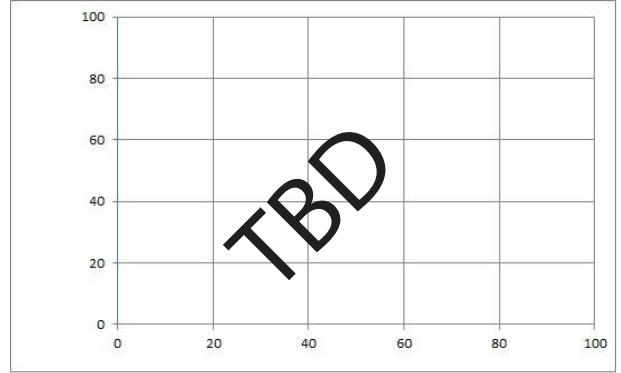

**Chromaticity Change vs. Junction Temp**

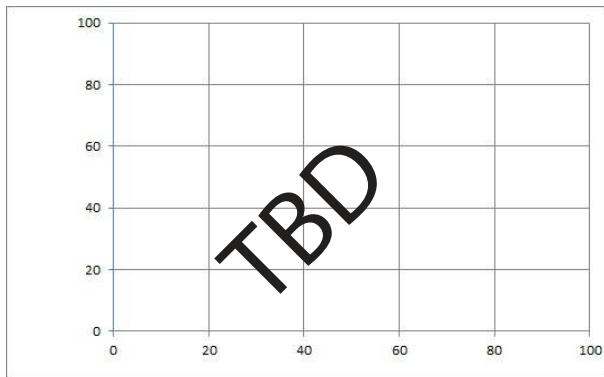

**Chromaticity Change vs. Forward Current**

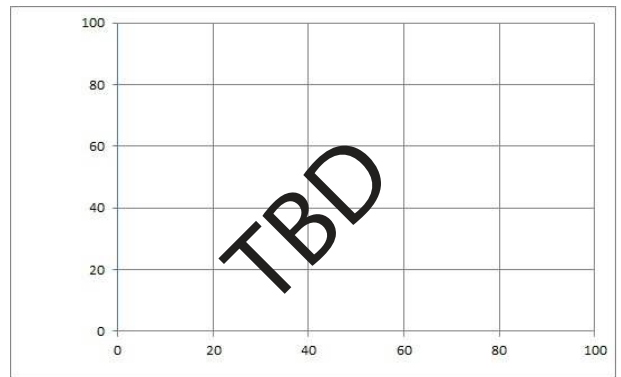

**Typical Polar Radiation Pattern**

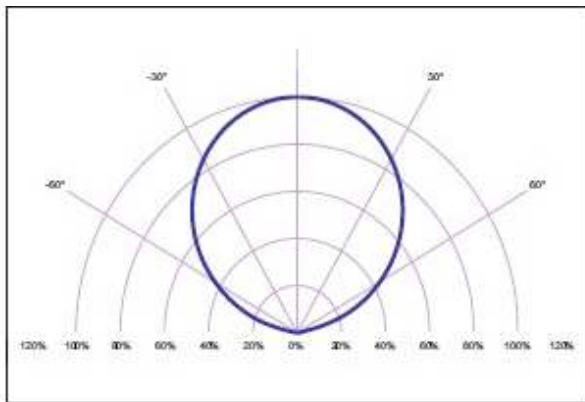

**Typical Angular Radiation Pattern**

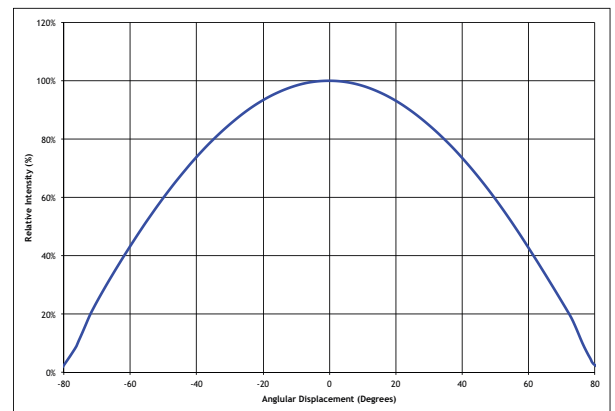

*Note 2: Mean expected lifetime in dependence of junction temperature at 1.5 A/mm<sup>2</sup> in continuous operation. Lifetime defined as time to 70% of initial intensity. Based on lifetime test data. Data can be used to model failure rate over typical product lifetime (contact Luminus for lifetime reliability test data for 1A/mm<sup>2</sup> condition).*

*Note 3: Lumen maintenance in dependence of time at 1.5 A/mm<sup>2</sup> in continuous operation with junction temperatures of 130 °C.*

### Thermal Resistance

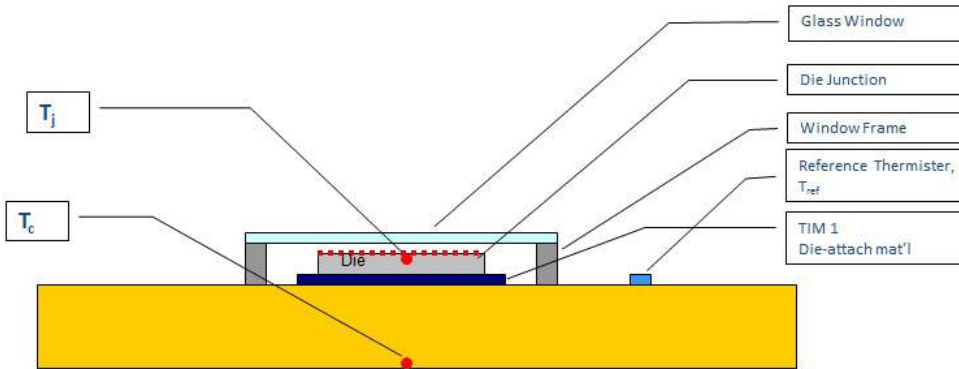

#### Typical Thermal Resistance

$R_{\theta j-c}^{-1}$	0.51 °C/W
$R_{\theta j-ref}^{-1}$	0.53 °C/W

Note 1: Thermal resistance values are preliminary based on modeled results.

Item	Vendor	Part	Description
Recommended conducting TIM	Graf-Tech	eGraph HT-1205	Graphite foil TIM
	Indium Corp	Heat spring	In-alloy foil TIM
	Arctic Silver	Arctic Silver 5	Thermal grease
	Shin-Etsu	7783D	Thermal grease
Recommended insulating TIM	Fujipoly	XR-m 30X-m	Electrically isolating TIM
Insulating T-washer	Washers USA	12SWS0238	Nylon shoulder washer
Low profile mounting screw	McMaster-Carr	92855A310	M3 x 6mm long socket low head cap screw

### Thermistor Information

The on-board thermistor used in CBT-140 LEDs mounted on core-boards is from Murata Manufacturing Co. The global part number is NCP15XH103J03RC. Please see <http://www.murata.com/> for details on calculating thermistor temperature.

### Electrical Pinout

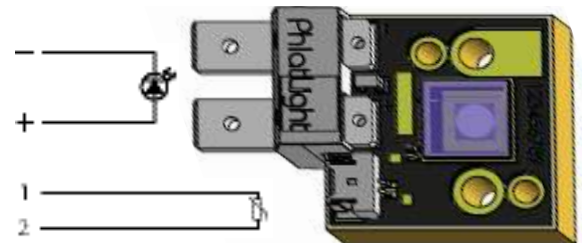

**Mechanical Dimensions – CBT-140 Emitter**

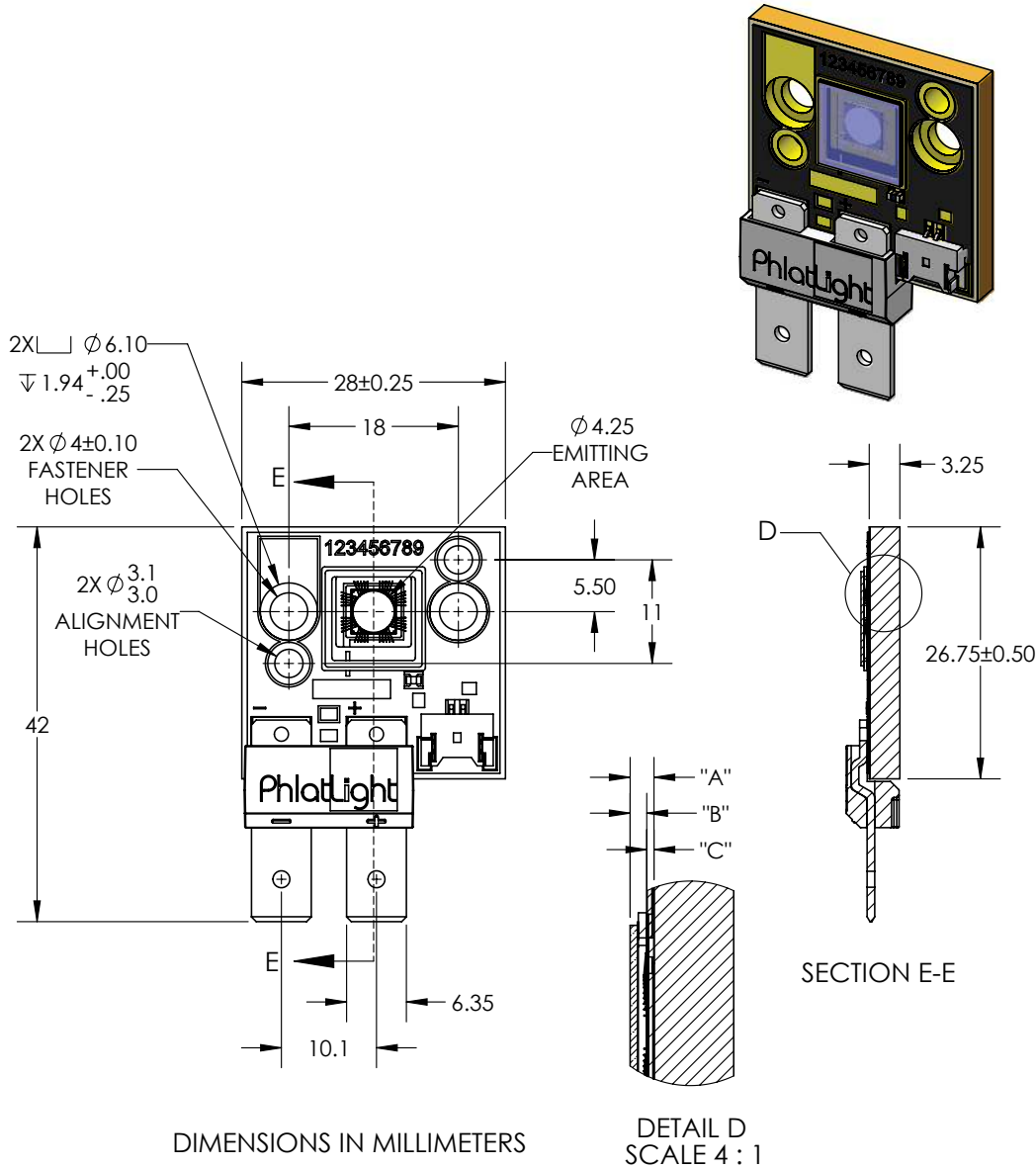

DIMENSION NAME	DESCRIPTION	NOMINAL DIMENSION	TOLERANCE
"A"	TOP OF METAL SUBSTRATE TO TOP OF GLASS	0.94	±0.07
"B"	EMITTING AREA TO TOP OF GLASS	0.66	±0.07
"C"	TOP OF METAL SUBSTRATE TO EMITTING AREA	0.28	±0.05

DWG-001997

Recommended connector for Anode and Cathode: Panduit Disco Lok™ Series P/N: DNG14-250FL-C  
Thermistor Connector: MOLEX P/N 53780-0270. Recommended Female: MOLEX P/N 51146-0200 or equivalent  
For detailed drawing please refer to DWG-001997 document

### Ordering Information

Ordering Part Number <sup>1,2,3,4</sup>	Color	Description
CBT-140-WCS-C15-TA120	Cool White	White Big Chip LED™ CBT-140 consisting of a 14 mm <sup>2</sup> LED, thermistor, and connector, mounted on a copper-core PCB
CBT-140-WDH-C15-QB220	Daylight White	White Big Chip LED™ CBT-140 consisting of a 14 mm <sup>2</sup> LED, thermistor, and connector, mounted on a copper-core PCB
CBT-140-WTH-C15-PB720	Tungsten White	White Big Chip LED™ CBT-140 consisting of a 14 mm <sup>2</sup> LED, thermistor, and connector, mounted on a copper-core PCB

Note 1: TA120 - denotes a bin kit comprising of all flux bins with a minimum flux of 3,200 lumens and chromaticity bins at cool white color point.

Note 2: QB220 - denotes a bin kit comprising of all flux bins with a minimum flux of 2,260 lumens and chromaticity bins at daylight white color point.

Note 3: PB720 - denotes a bin kit comprising of all flux bins with a minimum flux of 1,965 lumens and chromaticity bins at tungsten white color point.

Note 4: Standard packaging increment (SPI) is 10.

The products, their specifications and other information appearing in this document are subject to change by Luminus Devices without notice. Luminus Devices assumes no liability for errors that may appear in this document, and no liability otherwise arising from the application or use of the product or information contained herein. None of the information provided herein should be considered to be a representation of the fitness or suitability of the product for any particular application or as any other form of warranty. Luminus Devices' product warranties are limited to only such warranties as accompany a purchase contract or purchase order for such products. Nothing herein is to be construed as constituting an additional warranty. No information contained in this publication may be considered as a waiver by Luminus Devices of any intellectual property rights that Luminus Devices may have in such information. Big Chip LEDs™ is a registered trademark of Luminus Devices, Inc., all rights reserved.

This product is protected by U.S. Patents 6,831,302; 7,074,631; 7,083,993; 7,084,434; 7,098,589; 7,105,861; 7,138,666; 7,166,870; 7,166,871; 7,170,100; 7,196,354; 7,211,831; 7,262,550; 7,274,043; 7,301,271; 7,341,880; 7,344,903; 7,345,416; 7,348,603; 7,388,233; 7,391,059 Patents Pending in the U.S. and other countries.