



# Multilayer Ceramic Capacitors

## Series/Type: Z5U (Y5U)

The following products presented in this data sheet are being withdrawn.

Ordering Code	Substitute Product	Date of Withdrawal	Deadline Last Orders	Last Shipments
B37985N5475M000		16.03.2007	30.06.2007	30.09.2007
B37985N5475M051		16.03.2007	30.06.2007	30.09.2007
B37985N5475M054		16.03.2007	30.06.2007	30.09.2007



Ordering Code	Substitute Product	Date of Withdrawal	Deadline Last Orders	Last Shipments
B37985N5335M000		16.03.2007	30.06.2007	30.09.2007
B37985N5335M051		16.03.2007	30.06.2007	30.09.2007
B37985N5335M054		16.03.2007	30.06.2007	30.09.2007
B37985N5225M000		16.03.2007	30.06.2007	30.09.2007
B37985N5225M051		16.03.2007	30.06.2007	30.09.2007
B37985N5225M054		16.03.2007	30.06.2007	30.09.2007
B37985N5155M000		16.03.2007	30.06.2007	30.09.2007
B37985N5155M051		16.03.2007	30.06.2007	30.09.2007
B37985N5155M054		16.03.2007	30.06.2007	30.09.2007
B37988G5105M000	B37987F5105K000	16.03.2007	30.06.2007	30.09.2007
B37988G5105M051	B37987F5105K051	16.03.2007	30.06.2007	30.09.2007
B37988G5105M054	B37987F5105K054	16.03.2007	30.06.2007	30.09.2007
B37988G5684M000		16.03.2007	30.06.2007	30.09.2007
B37988G5684M051		16.03.2007	30.06.2007	30.09.2007
B37988G5684M054		16.03.2007	30.06.2007	30.09.2007
B37988G5474M000	B37987F5474K000	16.03.2007	30.06.2007	30.09.2007
B37988G5474M051	B37987F5474K051	16.03.2007	30.06.2007	30.09.2007
B37988G5474M054	B37987F5474K054	16.03.2007	30.06.2007	30.09.2007
B37988G5334M000		16.03.2007	30.06.2007	30.09.2007
B37988G5334M051	B37987F5334K051	16.03.2007	30.06.2007	30.09.2007
B37988G5334M054	B37987F5334K054	16.03.2007	30.06.2007	30.09.2007
B37988G5224M000	B37987F5224K000	16.03.2007	30.06.2007	30.09.2007
B37988G5224M051	B37987F5224K051	16.03.2007	30.06.2007	30.09.2007
B37988G5224M054	B37987F5224K054	16.03.2007	30.06.2007	30.09.2007
B37988N5105M000	B37987M5105K000	16.03.2007	30.06.2007	30.09.2007
B37988N5105M051		16.03.2007	30.06.2007	30.09.2007
B37988N5105M054	B37987M5105K054	16.03.2007	30.06.2007	30.09.2007
B37988N5684M000		16.03.2007	30.06.2007	30.09.2007
B37988N5684M051		16.03.2007	30.06.2007	30.09.2007
B37988N5684M054		16.03.2007	30.06.2007	30.09.2007
B37988N5474M000		16.03.2007	30.06.2007	30.09.2007
B37988N5474M051		16.03.2007	30.06.2007	30.09.2007
B37988N5474M054		16.03.2007	30.06.2007	30.09.2007
B37988N5334M000	B37987M5474K000	16.03.2007	30.06.2007	30.09.2007
B37988N5334M051	B37987M5334K051	16.03.2007	30.06.2007	30.09.2007
B37988N5334M054		16.03.2007	30.06.2007	30.09.2007
B37988N5224M000	B37987M5224K000	16.03.2007	30.06.2007	30.09.2007
B37988N5224M051	B37987M5224K051	16.03.2007	30.06.2007	30.09.2007



Ordering Code	Substitute Product	Date of Withdrawal	Deadline Last Orders	Last Shipments
B37988N5224M054	B37987M5224K054	16.03.2007	30.06.2007	30.09.2007
B37982G5154M000		16.03.2007	30.06.2007	30.09.2007
B37982G5154M051		16.03.2007	30.06.2007	30.09.2007
B37982G5154M054		16.03.2007	30.06.2007	30.09.2007
B37982G5104M000	B37981F5104K000	16.03.2007	30.06.2007	30.09.2007
B37982G5104M051	B37981F5104K051	16.03.2007	30.06.2007	30.09.2007
B37982G5104M054	B37981F5104K054	16.03.2007	30.06.2007	30.09.2007
B37982G5683M000		16.03.2007	30.06.2007	30.09.2007
B37982G5683M051		16.03.2007	30.06.2007	30.09.2007
B37982G5683M054		16.03.2007	30.06.2007	30.09.2007
B37982G5473M000	B37981F5473K000	16.03.2007	30.06.2007	30.09.2007
B37982G5473M051	B37981F5473K051	16.03.2007	30.06.2007	30.09.2007
B37982G5473M054	B37981F5473K054	16.03.2007	30.06.2007	30.09.2007
B37982G5333M000		16.03.2007	30.06.2007	30.09.2007
B37982G5333M051		16.03.2007	30.06.2007	30.09.2007
B37982G5333M054		16.03.2007	30.06.2007	30.09.2007
B37982G5223M000	B37981F5223K000	16.03.2007	30.06.2007	30.09.2007
B37982G5223M051	B37981F5223K051	16.03.2007	30.06.2007	30.09.2007
B37982G5223M054	B37981F5223K054	16.03.2007	30.06.2007	30.09.2007
B37982G5153M000		16.03.2007	30.06.2007	30.09.2007
B37982G5153M051	B37981F5153K051	16.03.2007	30.06.2007	30.09.2007
B37982G5153M054		16.03.2007	30.06.2007	30.09.2007
B37982G5103M000	B37981F5103K000	16.03.2007	30.06.2007	30.09.2007
B37982G5103M051	B37981F5103K000	16.03.2007	30.06.2007	30.09.2007
B37982G5103M054	B37981F5103K000	16.03.2007	30.06.2007	30.09.2007
B37982N5154M000		16.03.2007	30.06.2007	30.09.2007
B37982N5154M051		16.03.2007	30.06.2007	30.09.2007
B37982N5154M054		16.03.2007	30.06.2007	30.09.2007
B37982N5104M000	B37981M5104K000	16.03.2007	30.06.2007	30.09.2007
B37982N5104M051	B37981M5104K051	16.03.2007	30.06.2007	30.09.2007
B37982N5104M054	B37981M5104K054	16.03.2007	30.06.2007	30.09.2007
B37982N5683M000		16.03.2007	30.06.2007	30.09.2007
B37982N5683M051		16.03.2007	30.06.2007	30.09.2007
B37982N5683M054		16.03.2007	30.06.2007	30.09.2007
B37982N5473M000	B37981M5473K000	16.03.2007	30.06.2007	30.09.2007
B37982N5473M051	B37981M5473K051	16.03.2007	30.06.2007	30.09.2007
B37982N5473M054	B37981M5473K054	16.03.2007	30.06.2007	30.09.2007
B37982N5333M000	B37981M5333K000	16.03.2007	30.06.2007	30.09.2007



Ordering Code	Substitute Product	Date of Withdrawal	Deadline Last Orders	Last Shipments
B37982N5333M051		16.03.2007	30.06.2007	30.09.2007
B37982N5333M054		16.03.2007	30.06.2007	30.09.2007
B37982N5223M000	B37981M5223K000	16.03.2007	30.06.2007	30.09.2007
B37982N5223M051	B37981M5223K051	16.03.2007	30.06.2007	30.09.2007
B37982N5223M054	B37981M5223K054	16.03.2007	30.06.2007	30.09.2007
B37982N5153M000		16.03.2007	30.06.2007	30.09.2007
B37982N5153M051		16.03.2007	30.06.2007	30.09.2007
B37982N5153M054		16.03.2007	30.06.2007	30.09.2007
B37982N5103M000	B37981M5103K000	16.03.2007	30.06.2007	30.09.2007
B37982N5103M051	B37981M5103K051	16.03.2007	30.06.2007	30.09.2007
B37982N5103M054	B37981M5103K054	16.03.2007	30.06.2007	30.09.2007

For further information please contact your nearest EPCOS sales office, which will also support you in selecting a suitable substitute. The addresses of our worldwide sales network are presented at [www.epcos.com/sales](http://www.epcos.com/sales).

Z5U (Y5U)

Ordering code system

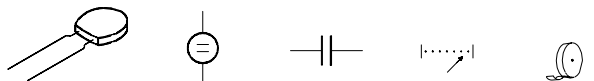

**B37979N**    **1**    **100**    **K**    **0**    **54**

**Packaging**

51  $\triangleq$  cardboard tape, reel packing (360-mm reel)  
**54  $\triangleq$  Ammo packing (standard)**  
 00  $\triangleq$  bulk

**Internal coding**

**Capacitance tolerance**

**J  $\triangleq$   $\pm$  5% (standard for C0G)**  
**K  $\triangleq$   $\pm$  10% (standard for X7R)**  
**M  $\triangleq$   $\pm$  20% (standard for Z5U (Y5U))**

**Capacitance**, coded    101  $\triangleq$  10 · 10<sup>1</sup> pF = 100 pF  
 (example)                    222  $\triangleq$  22 · 10<sup>2</sup> pF = 2.2 nF  
                                      473  $\triangleq$  47 · 10<sup>3</sup> pF = 47 nF

**Rated voltage**

Rated voltage [VDC]	50	100
Code	5	1

<b>Type and size</b>			
With radial leads EIA standard	Temperature characteristic		
	C0G	X7R	Z5U (Y5U)
Lead spacing 2.5 mm 5.5 × 5.0 × 2.5 6.5 × 5.0 × 2.5	B37979N B37986N	B37981M B37987M	B37982N B37988N
Lead spacing 5.0 mm 5.5 × 5.0 × 2.5 6.5 × 5.0 × 2.5 9.0 × 7.5 × 2.5	B37979G B37986G —	B37981F B37987F B37984M	B37982G B37988G B37985N

**Z5U (Y5U)**
**Features**

- Extremely high volumetric efficiency
- Non-linear capacitance change
- Y5U characteristic is also fulfilled

**Applications**

- Blocking
- Coupling
- Decoupling
- Interference suppression

**Termination**

- Parallel wire leads, iron-nickel, tinned
- Crimped leads
- Non-standard lead lengths on request

**Marking**

- Rated capacitance, tolerance, manufacturer's logo, ceramic material, voltage

**Delivery mode**

- Cardboard tape in Ammo packing (standard)
- Cardboard tape on 360-mm reel or bulk on request

**Electrical data**

Temperature characteristic		Z5U (Y5U) <sup>1)</sup>	
Max. relative capacitance change within -30 °C to +85 °C	$\Delta C/C$	+22/-56	%
Climatic category (IEC 60068-1)		30/85/56	
Standard		EIA	
Dielectric		Class 2	
Rated voltage <sup>2)</sup>	$V_R$	50	VDC
Test voltage	$V_{test}$	$2.5 \cdot V_R/5$ s	VDC
Capacitance range / E series	$C_R$	10 nF ... 4.7 $\mu$ F (E6)	
Dissipation factor (limit value)	$\tan \delta$	$<50 \cdot 10^{-3}$	
Insulation resistance <sup>3)</sup> at +25 °C	$R_{ins}$	$>10^4$	M $\Omega$
Time constant <sup>3)</sup> at +25 °C	$\tau$	$>500$	s
Operating temperature range	$T_{op}$	-30 ... +85	°C
Ageing <sup>4)</sup>		yes	

1) Y5U specification is also fulfilled.

2) Note: No operation on AC line.

3) For  $C_R > 10$  nF the time constant  $\tau = C \cdot R_{ins}$  is given.

4) Refer to chapter "General technical information", "Ageing".

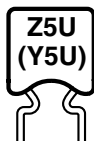

## Multilayer ceramic capacitors

### Z5U (Y5U)

#### Capacitance tolerances

Code letter	M
Tolerance	±20%

#### Dimensional drawing

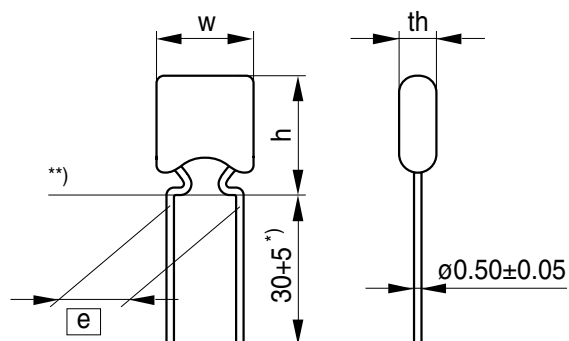

- \*) Lead length for bulk packaging  
 \*\*) Seating plane to IEC 600717

KKE0456-R-E

#### Dimensions (mm)

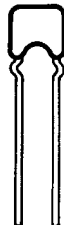
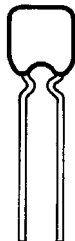
	Lead spacing $e = 2.5 + 0.6/-0.1$ mm	
Type	B37982N	B37988N
		
$h_{max}$	5.5	6.5
$w_{max}$	5.0	5.0
$th_{max}$	2.5	2.5

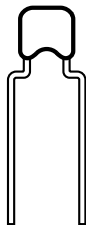
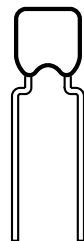
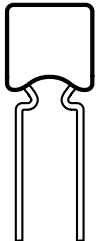
	Lead spacing $e = 5.0 + 0.6/-0.1$ mm		
Type	B37982G	B37988G	B37985N
			
$h_{max}$	5.5	6.5	9.0
$w_{max}$	5.0	5.0	7.5
$th_{max}$	2.5	2.5	2.5



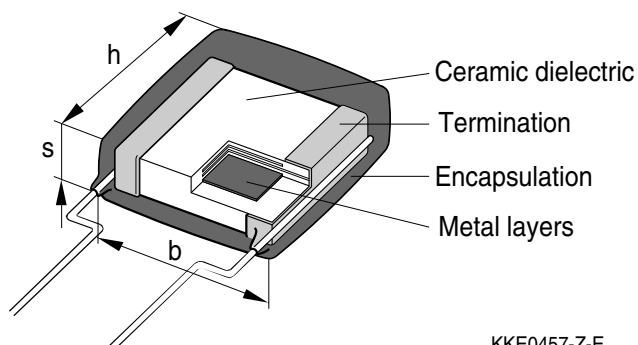

#### Termination

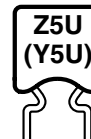

KKE0457-Z-E



Product range leaded capacitors, Z5U (Y5U)

Lead spacing	2.5 mm				5.0 mm					
										
h × b × s (mm)	5.5 × 5.0 × 2.5		6.5 × 5.0 × 2.5		5.5 × 5.0 × 2.5		6.5 × 5.0 × 2.5		9.0 × 7.5 × 2.5	
Type	B37982N		B37988N		B37982G		B37988G		B37985N	
$V_R$ (VDC)	50		50		50		50		50	
$C_R$	50		50		50		50		50	
10 nF	■				■					
15 nF	■				■					
22 nF	■				■					
33 nF	■				■					
47 nF	■				■					
68 nF	■				■					
100 nF	■				■					
150 nF	■				■					
220 nF			■				■			
330 nF			■				■			
470 nF			■				■			
680 nF			■				■			
1.0 μF			■				■			
1.5 μF									■	
2.2 μF									■	
3.3 μF									■	
4.7 μF									■	

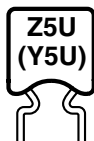

**Multilayer ceramic capacitors**
**Z5U (Y5U)**
**Ordering codes and packing for Z5U (Y5U), 50 VDC, lead spacing 2.5 mm**

C <sub>R</sub>	Ordering code	Ammo packing	Reel packing	Bulk
		** $\triangle$ 54	** $\triangle$ 51	** $\triangle$ 00
		pcs	pcs/reel	pcs

**B37982, 50 VDC**

10 nF	B37982N5103M0**	2500	2500	2000
15 nF	B37982N5153M0**	2500	2500	2000
22 nF	B37982N5223M0**	2500	2500	2000
33 nF	B37982N5333M0**	2500	2500	2000
47 nF	B37982N5473M0**	2500	2500	2000
68 nF	B37982N5683M0**	2500	2500	2000
100 nF	B37982N5104M0**	2500	2500	2000
150 nF	B37982N5154M0**	2500	2500	2000

**B37988, 50 VDC**

220 nF	B37988N5224M0**	2500	2500	2000
330 nF	B37988N5334M0**	2500	2500	2000
470 nF	B37988N5474M0**	2500	2500	2000
680 nF	B37988N5684M0**	2500	2500	2000
1.0 $\mu$ F	B37988N5105M0**	2500	2500	2000

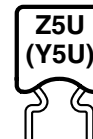
**Ordering codes and packing for Z5U (Y5U), 50 VDC, lead spacing 5.0 mm**

C <sub>R</sub>	Ordering code	Ammo packing	Reel packing	Bulk
		** $\triangle$ 54	** $\triangle$ 51	** $\triangle$ 00
		pcs	pcs/reel	pcs

**B37982, 50 VDC**

10 nF	B37982G5103M0**	2500	2500	2000
15 nF	B37982G5153M0**	2500	2500	2000
22 nF	B37982G5223M0**	2500	2500	2000
33 nF	B37982G5333M0**	2500	2500	2000
47 nF	B37982G5473M0**	2500	2500	2000
68 nF	B37982G5683M0**	2500	2500	2000
100 nF	B37982G5104M0**	2500	2500	2000
150 nF	B37982G5154M0**	2500	2500	2000

**B37988, 50 VDC**

220 nF	B37988G5224M0**	2500	2500	2000
330 nF	B37988G5334M0**	2500	2500	2000
470 nF	B37988G5474M0**	2500	2500	2000
680 nF	B37988G5684M0**	2500	2500	2000
1.0 $\mu$ F	B37988G5105M0**	2500	2500	2000

**B37985, 50 VDC**

1.5 $\mu$ F	B37985N5155M0**	2000	2000	1000
2.2 $\mu$ F	B37985N5225M0**	2000	2000	1000
3.3 $\mu$ F	B37985N5335M0**	2000	2000	1000
4.7 $\mu$ F	B37985N5475M0**	2000	2000	1000

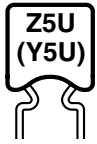

## Multilayer ceramic capacitors

### Z5U (Y5U)

#### Typical characteristics

Capacitance change  $\Delta C/C_{25}$  versus temperature T

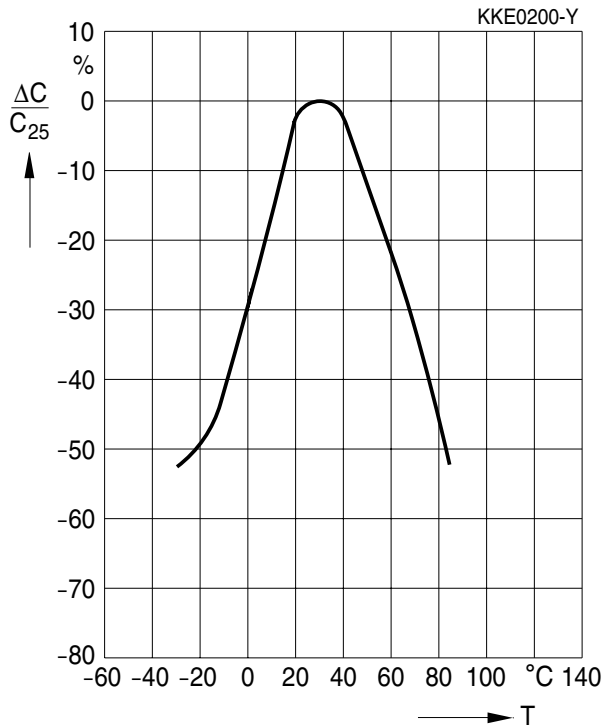

Capacitance change  $\Delta C/C_0$  versus superimposed DC voltage V

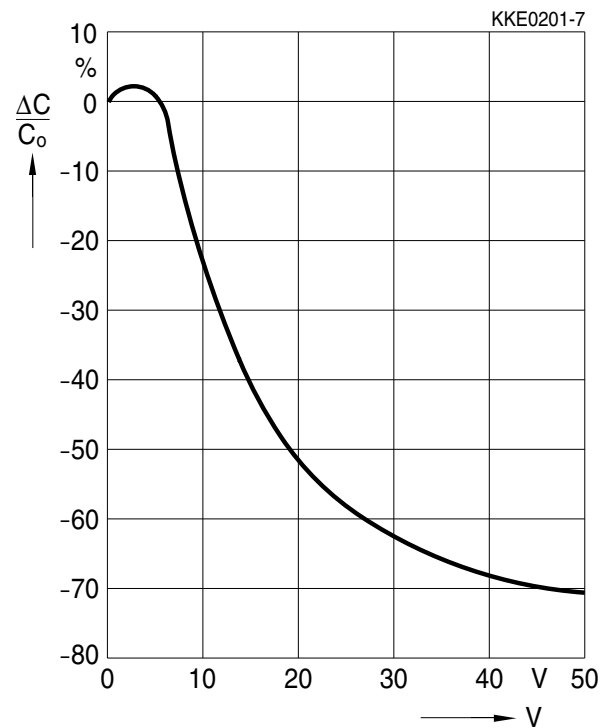

Insulation resistance  $R_{ins}$  versus temperature T

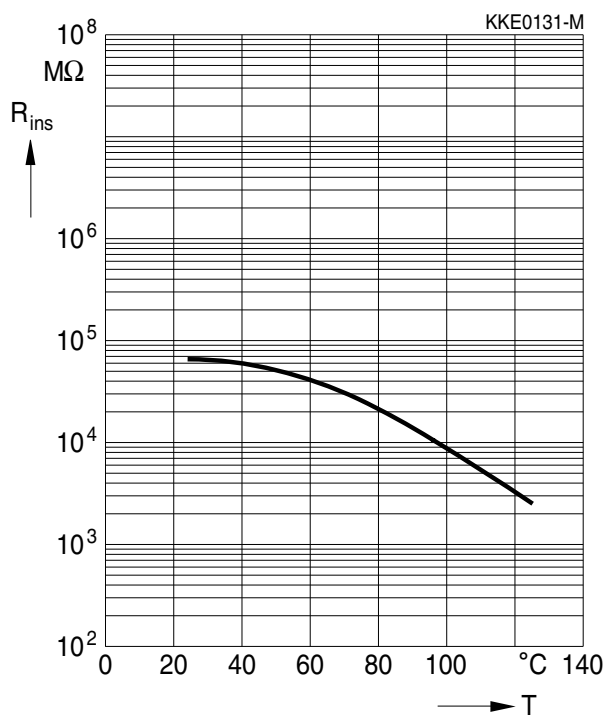

Dissipation factor  $\tan \delta$  versus temperature T

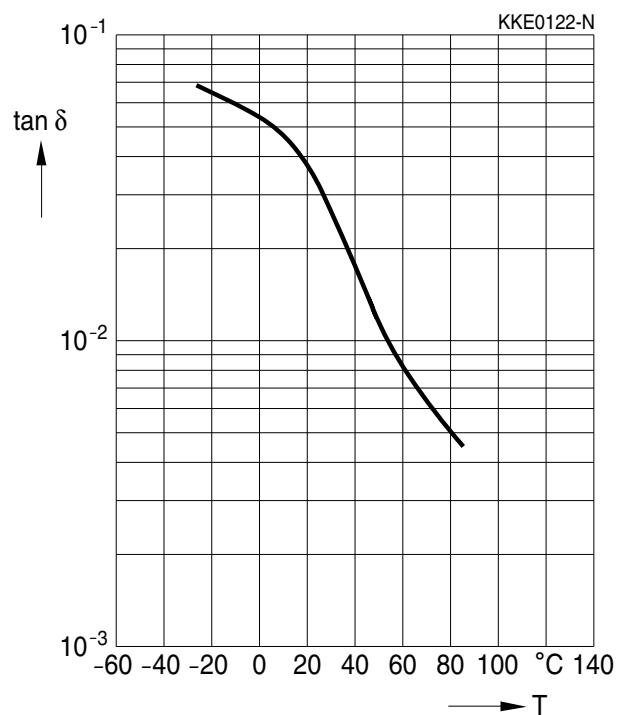

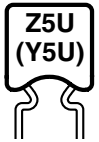

### Typical characteristics

Impedance  $|Z|$  versus frequency  $f$

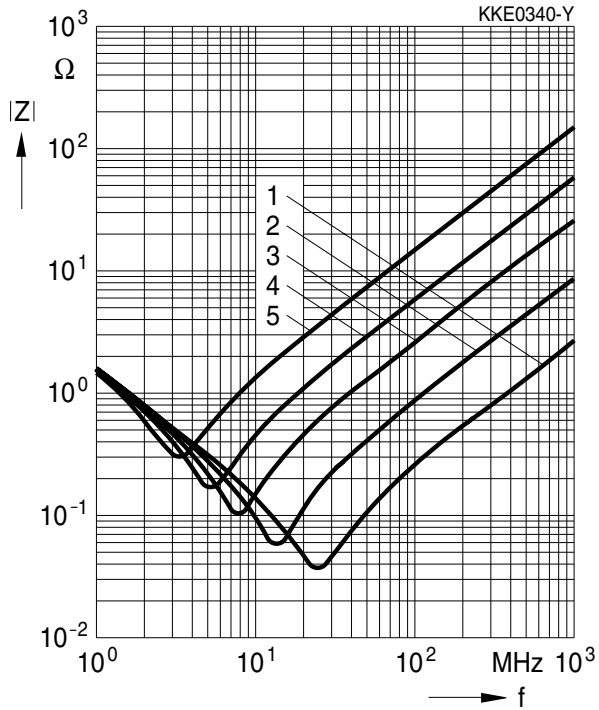

- 1: SMD chip capacitors
- 2: 1.5 mm lead length
- 3: 5.0 mm lead length
- 4: 10.0 mm lead length
- 5: 20.0 mm lead length

Capacitance change  $\Delta C/C_1$  versus time  $t$

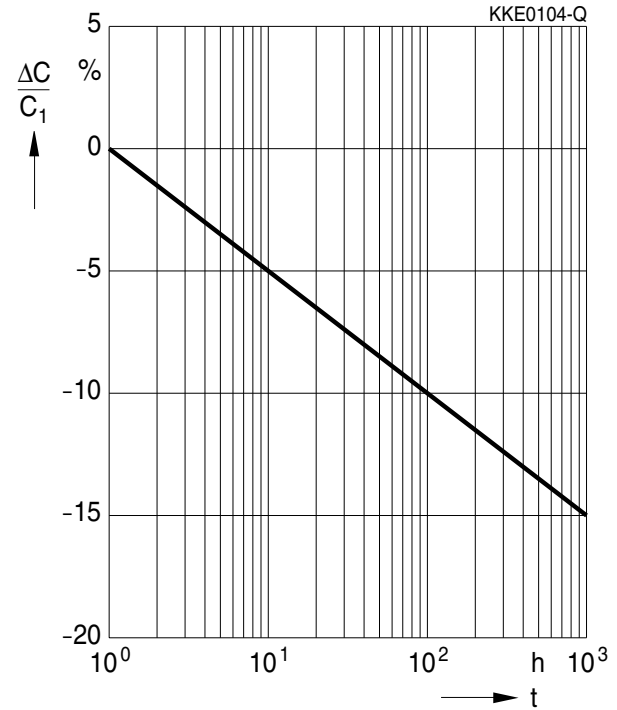

### Notes on the selection of ceramic capacitors

In the selection of ceramic capacitors, the following criteria must be considered:

1. Depending on the application, ceramic capacitors used to meet high quality requirements should at least satisfy the specifications to AEC-Q200. They must meet quality requirements going beyond this level in terms of ruggedness (e.g. mechanical, thermal or electrical) in the case of critical circuit configurations and applications (e.g. in safety-relevant applications such as ABS and airbag equipment or durable industrial goods).
2. At the connection to the battery or power supply (e.g. clamp 15 or 30 in the automobile) and at positions with stranding potential, to reduce the probability of short circuits following a fracture, two ceramic capacitors must be connected in series and/or a ceramic capacitor with integrated series circuit should be used. The MLSC from EPCOS contains such a series circuit in a single component.
3. Ceramic capacitors with the temperature characteristics Z5U and Y5V do not satisfy the requirements to AEC-Q200 and are mechanically and electrically less rugged than C0G or X7R/X8R ceramic capacitors. In applications that must satisfy high quality requirements, therefore, these capacitors should not be used as discrete components (see the chapter “Effects on mechanical, thermal and electrical stress”, point 1.4).
4. For ESD protection, preference should be given to the use of multilayer varistors (MLV) (see the chapter “Effects on mechanical, thermal and electrical stress”, point 1.4).
5. An application-specific derating or continuous operating voltage must be considered in order to cushion (unexpected) additional stresses (see the chapter “Reliability”).

### The following should be considered in circuit board design

1. If technically feasible in the application, preference should be given to components having an optimal geometrical design.
2. At least FR4 circuit board material should be used.
3. Geometrically optimal circuit boards should be used, ideally those that cannot be deformed.
4. Ceramic capacitors must always be placed a sufficient minimum distance from the edge of the circuit board. High bending forces may be exerted there when the panels are separated and during further processing of the board (such as when incorporating it into a housing).
5. Ceramic capacitors should always be placed parallel to the possible bending axis of the circuit board.
6. No screw connections should be used to fix the board or to connect several boards. Components should not be placed near screw holes. If screw connections are unavoidable, they must be cushioned (for instance by rubber pads).

**The following should be considered in the placement process**

1. Ensure correct positioning of the ceramic capacitor on the solder pad.
2. Caution when using casting, injection-molded and molding compounds and cleaning agents, as these may damage the capacitor.
3. Support the circuit board and reduce the placement forces.
4. A board should not be straightened (manually) if it has been distorted by soldering.
5. Separate panels with a peripheral saw, or better with a milling head (no dicing or breaking).
6. Caution in the subsequent placement of heavy or leaded components (e.g. transformers or snap-in components): danger of bending and fracture.
7. When testing, transporting, packing or incorporating the board, avoid any deformation of the board not to damage the components.
8. Avoid the use of excessive force when plugging a connector into a device soldered onto the board.
9. Ceramic capacitors must be soldered only by the mode (reflow or wave soldering) permissible for them (see the chapter "Soldering directions").
10. When soldering the most gentle solder profile feasible should be selected (heating time, peak temperature, cooling time) in order to avoid thermal stresses and damage.
11. Ensure the correct solder meniscus height and solder quantity.
12. Ensure correct dosing of the cement quantity.
13. Ceramic capacitors with an AgPd external termination are not suited for the lead-free solder process: they were developed only for conductive adhesion technology.

This listing does not claim to be complete, but merely reflects the experience of EPCOS AG.

The following applies to all products named in this publication:

1. Some parts of this publication contain **statements about the suitability of our products for certain areas of application**. These statements are based on our knowledge of typical requirements that are often placed on our products in the areas of application concerned. We nevertheless expressly point out **that such statements cannot be regarded as binding statements about the suitability of our products for a particular customer application**. As a rule, EPCOS is either unfamiliar with individual customer applications or less familiar with them than the customers themselves. For these reasons, it is always ultimately incumbent on the customer to check and decide whether an EPCOS product with the properties described in the product specification is suitable for use in a particular customer application.
2. We also point out that **in individual cases, a malfunction of passive electronic components or failure before the end of their usual service life cannot be completely ruled out in the current state of the art, even if they are operated as specified**. In customer applications requiring a very high level of operational safety and especially in customer applications in which the malfunction or failure of a passive electronic component could endanger human life or health (e.g. in accident prevention or life-saving systems), it must therefore be ensured by means of suitable design of the customer application or other action taken by the customer (e.g. installation of protective circuitry or redundancy) that no injury or damage is sustained by third parties in the event of malfunction or failure of a passive electronic component.
3. **The warnings, cautions and product-specific notes must be observed.**
4. In order to satisfy certain technical requirements, **some of the products described in this publication may contain substances subject to restrictions in certain jurisdictions (e.g. because they are classed as “hazardous”)**. Useful information on this will be found in our Material Data Sheets on the Internet ([www.epcos.com/material](http://www.epcos.com/material)). Should you have any more detailed questions, please contact our sales offices.
5. We constantly strive to improve our products. Consequently, **the products described in this publication may change from time to time**. The same is true of the corresponding product specifications. Please check therefore to what extent product descriptions and specifications contained in this publication are still applicable before or when you place an order.  
We also **reserve the right to discontinue production and delivery of products**. Consequently, we cannot guarantee that all products named in this publication will always be available.
6. Unless otherwise agreed in individual contracts, **all orders are subject to the current version of the “General Terms of Delivery for Products and Services in the Electrical Industry” published by the German Electrical and Electronics Industry Association (ZVEI)**.
7. The trade names EPCOS, EPCOS-JONES, Baoke, CeraDiode, CSSP, MLSC, PhaseCap, PhaseMod, SIFERRIT, SIFI, SIKOREL, SilverCap, SIMID, SIOV, SIP5D, SIP5K, UltraCap, WindCap are **trademarks registered or pending** in Europe and in other countries. Further information will be found on the Internet at [www.epcos.com/trademarks](http://www.epcos.com/trademarks).