



Main

| | |
|------------------------------|---|
| Product destination | Asynchronous motors |
| Component name | ATV12 |
| Built-in fan | Without |
| Phase | 1 phase |
| Motor power kW | 0.37 kW |
| Maximum Horse Power Rating | 0.55 hp |
| Line current | 11.4 A 100 V 9.3 A 120 V |
| Speed range | 1...20 |
| IP degree of protection | IP20 without blanking plate on upper part |
| Range of Product | Altivar 12 |
| Product or Component Type | Variable speed drive |
| Product Specific Application | Simple machine |
| Communication Port Protocol | Modbus |
| [Us] rated supply voltage | 100...120 V - 15...10 % |
| EMC filter | Without EMC filter |

Complementary

| | |
|------------------------------|---|
| Supply frequency | 50/60 Hz +/- 5 % |
| Connector type | 1 RJ45 on front face)Modbus |
| Physical interface | 2-wire RS 485 Modbus |
| Transmission frame | RTU Modbus |
| Transmission rate | 4800 bit/s 9600 bit/s 19200 bit/s 38400 bit/s |
| Number of addresses | 1...247 Modbus |
| Communication service | Read holding registers (03) 29 words Write single register (06) 29 words Write multiple registers (16) 27 words Read/Write multiple registers (23) 4/4 words Read device identification (43) |
| Continuous output current | 2.4 A 4 kHz |
| Maximum transient current | 3.6 A 60 s |
| Speed drive output frequency | 0.5...400 Hz |
| Braking torque | Up to 70 % of nominal motor torque without braking resistor |
| Output voltage | 200...240 V 3 phase |
| Electrical connection | Terminal 3.5 mm ² , AWG 12 L1, L2, L3, U, V, W, PA, PC) |
| Tightening torque | 7.08 lbf.in (0.8 N.m) |
| Insulation | Electrical between power and control |
| Supply | Internal supply for reference potentiometer 5 V DC 4.75...5.25 V), <10 mA overload and short-circuit protection Internal supply for logic inputs 24 V DC 20.4...28.8 V), <100 mA overload and short-circuit protection |
| Analogue input type | Configurable current AI1 0...20 mA 250 Ohm Configurable voltage AI1 0...10 V 30 kOhm Configurable voltage AI1 0...5 V 30 kOhm |

The information provided in this documentation contains general descriptions and/or technical characteristics of the performance of the products contained herein. This documentation is not intended as a substitute for and is not to be used for determining suitability or reliability of these products for specific user applications. It is the duty of any such user or integrator to perform the appropriate and complete risk analysis, evaluation and testing of the products with respect to the relevant specific application or use thereof. Neither Schneider Electric Industries SAS nor any of its affiliates or subsidiaries shall be responsible or liable for misuse of the information contained herein.

| | |
|--|---|
| Discrete input type | Programmable LI1...LI4 24 V 18...30 V |
| Discrete input logic | Negative logic (sink), > 16 V, < 10 V 3.5 kOhm Positive logic (source), 0...< 5 V, > 11 V |
| Sampling duration | 20 Ms +/- 1 ms logic input 10 ms analogue input |
| Linearity error | +/- 0.3 % of maximum value analogue input |
| Analogue output type | AO1 software-configurable voltage 0...10 V 470 Ohm 8 bits AO1 software-configurable current 0...20 mA 800 Ohm 8 bits |
| Discrete output type | Logic output LO+, LO- Protected relay output R1A, R1B, R1C 1 C/O |
| Minimum switching current | 5 mA 24 V DC logic relay |
| Maximum switching current | 2 A 250 V AC inductive cos phi = 0.4 L/R = 7 ms logic relay 2 A 30 V DC inductive cos phi = 0.4 L/R = 7 ms logic relay 3 A 250 V AC resistive cos phi = 1 L/R = 0 ms logic relay 4 A 30 V DC resistive cos phi = 1 L/R = 0 ms logic relay |
| Braking to standstill | By DC injection, <30 s |
| Frequency resolution | Analog input converter A/D, 10 bits Display unit 0.1 Hz |
| Time constant | 20 ms +/- 1 ms for reference change |
| Specific application | Commercial equipment |
| Variable speed drive application selection | Commercial equipment Mixer Commercial equipment Other application Textile Ironing |
| Motor starter type | Variable speed drive |
| Discrete input number | 4 |
| Discrete output number | 2 |
| Analogue input number | 1 |
| Analogue output number | 1 |
| Asynchronous motor control profile | Voltage/Frequency ratio (V/f) Quadratic voltage/frequency ratio Sensorless flux vector control |
| Transient overtorque | 150...170 % of nominal motor torque depending on drive rating and type of motor |
| Acceleration and deceleration ramps | S U Linear from 0 to 999.9 s |
| Motor slip compensation | Preset in factory Adjustable |
| Switching frequency | 2...16 kHz adjustable 4...16 kHz with derating factor |
| Nominal switching frequency | 4 kHz |
| Prospective line I _{sc} | 1 kA |
| Protection type | Line supply overvoltage Line supply undervoltage Overcurrent between output phases and earth Overheating protection Short-circuit between motor phases Against input phase loss in three-phase Thermal motor protection via the drive by continuous calculation of I ² t |
| Quantity per Set | Set of 1 |
| Width | 2.83 in (72 mm) |
| Height | 5.63 in (143 mm) |
| Depth | 4.77 in (121.2 mm) |
| Net Weight | 1.76 lb(US) (0.8 kg) |

Environment

| | |
|---------------------------------------|--|
| Electromagnetic emission | Radiated emissions environment 1 category C2 EN/IEC 61800-3 2...16 kHz shielded motor cable Conducted emissions with additional EMC filter environment 1 category C1 EN/IEC 61800-3 4...12 kHz shielded motor cable <16.40 ft (5 m) Conducted emissions with additional EMC filter environment 1 category C2 EN/IEC 61800-3 4...12 kHz shielded motor cable <65.62 ft (20 m) Conducted emissions with additional EMC filter environment 2 category C3 EN/IEC 61800-3 4...12 kHz shielded motor cable <65.62 ft (20 m) |
| Vibration resistance | 1 gn 13...200 Hz)EN/IEC 60068-2-6 1.5 mm peak to peak 3...13 Hz) - drive unmounted on symmetrical DIN rail - EN/IEC 60068-2-6 |
| Shock resistance | 15 gn 11 ms EN/IEC 60068-2-27 |
| Relative humidity | 5...95 % without condensation IEC 60068-2-3 5...95 % without dripping water IEC 60068-2-3 |
| Ambient air temperature for operation | 14...104 °F (-10...40 °C) protective cover from the top of the drive removed 104...140 °F (40...60 °C) with current derating 2.2 % per °C |
| Operating altitude | > 3280.84...6561.68 ft (> 1000...2000 m) with current derating 1 % per 100 m <= 3280.84 ft (1000 m) without derating |
| Operating position | Vertical +/- 10 degree |
| Product Certifications | UL C-tick GOST NOM CSA |
| Marking | CE |
| Assembly style | With heat sink |
| Electromagnetic compatibility | Electrical fast transient/burst immunity test level 4 EN/IEC 61000-4-4 Electrostatic discharge immunity test level 3 EN/IEC 61000-4-2 Immunity to conducted disturbances level 3 EN/IEC 61000-4-6 Radiated radio-frequency electromagnetic field immunity test level 3 EN/IEC 61000-4-3 Surge immunity test level 3 EN/IEC 61000-4-5 Voltage dips and interruptions immunity test EN/IEC 61000-4-11 |
| Noise level | 0 dB |
| Ambient Air Temperature for Storage | -13...158 °F (-25...70 °C) |

Ordering and shipping details

| | |
|-----------------------|-------------------------------------|
| Category | 22042 - ATV12 DRIVE AND ACCESSORIES |
| Discount Schedule | CP4B |
| GTIN | 3606480071027 |
| Nbr. of units in pkg. | 1 |
| Package weight(Lbs) | 2.27 lb(US) (1.031 kg) |
| Returnability | Yes |
| Country of origin | ID |

Packing Units

| | |
|------------------------------|-------------------------|
| Unit Type of Package 1 | PCE |
| Package 1 Height | 4.17 in (10.6 cm) |
| Package 1 width | 7.32 in (18.6 cm) |
| Package 1 Length | 7.32 in (18.6 cm) |
| Unit Type of Package 2 | P06 |
| Number of Units in Package 2 | 45 |
| Package 2 Weight | 130.95 lb(US) (59.4 kg) |
| Package 2 Height | 28.94 in (73.5 cm) |
| Package 2 width | 23.62 in (60 cm) |
| Package 2 Length | 31.50 in (80 cm) |

Offer Sustainability

| | |
|----------------------------|---|
| Sustainable offer status | Green Premium product |
| California proposition 65 | WARNING: This product can expose you to chemicals including: Lead and lead compounds, which is known to the State of California to cause cancer and birth defects or other reproductive harm. For more information go to www.P65Warnings.ca.gov |
| REACH Regulation | REACH Declaration |
| EU RoHS Directive | Pro-active compliance (Product out of EU RoHS legal scope) EU RoHS Declaration |
| Mercury free | Yes |
| RoHS exemption information | Yes |
| China RoHS Regulation | China RoHS Declaration |
| Environmental Disclosure | Product Environmental Profile |
| Circularity Profile | End Of Life Information |
| WEEE | The product must be disposed on European Union markets following specific waste collection and never end up in rubbish bins. |

Contractual warranty

| | |
|----------|-----------|
| Warranty | 18 months |
|----------|-----------|

Dimensions

Drive without EMC Conformity Kit

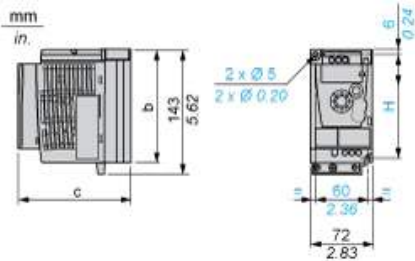

Dimensions in mm

| b | c | H |
|-----|-------|-----|
| 130 | 121.2 | 120 |

Dimensions in in.

| b | c | H |
|------|------|------|
| 5.12 | 4.77 | 4.72 |

Drive with EMC Conformity Kit

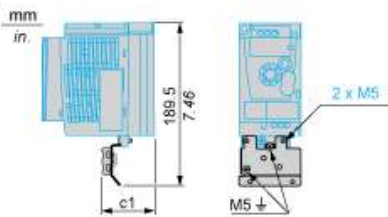

Dimensions in mm

| |
|----|
| c1 |
| 53 |

Dimensions in in.

| |
|------|
| c1 |
| 2.09 |

Mounting Recommendations

Clearance for Vertical Mounting

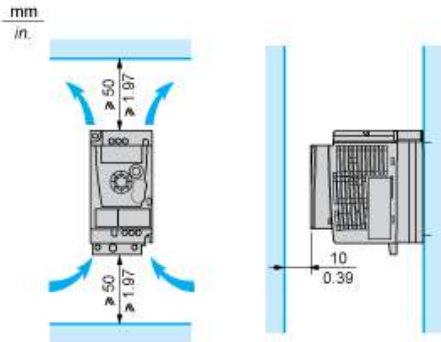

Mounting Type A

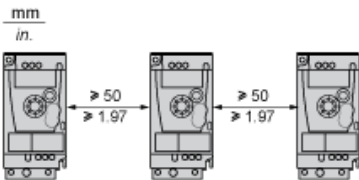

Mounting Type B

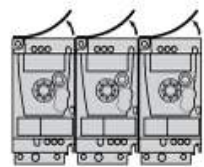

Remove the protective cover from the top of the drive.

Mounting Type C

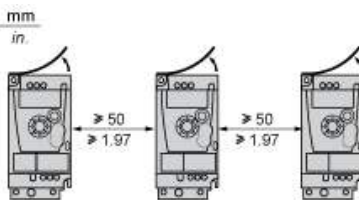

Remove the protective cover from the top of the drive.

Single-Phase Power Supply Wiring Diagram



- A1 Drive
- KM1 Contactor (only if a control circuit is needed)
- P1 2.2 kΩ reference potentiometer. This can be replaced by a 10 kΩ potentiometer (maximum).
- Q1 Circuit breaker
- (1) Negative logic (Sink)
- (2) Positive logic (Source) (factory set configuration)
- (3) 0...10 V or 0...20 mA

Recommended Schemes

2-Wire Control for Logic I/O with Internal Power Supply

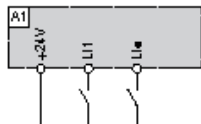

- L1: Forward
- L1•: Reverse
- A1: Drive

3-Wire Control for Logic I/O with Internal Power Supply

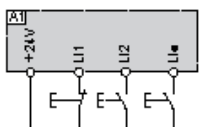

- L1: Stop
- L2: Forward
- L1•: Reverse
- A1: Drive

Analog Input Configured for Voltage with Internal Power Supply



- (1) 2.2 kΩ...10 kΩ reference potentiometer
- A1 : Drive

Analog Input Configured for Current with Internal Power Supply



- (2) 0-20 mA 4-20 mA supply
- A1 : Drive

Connected as Positive Logic (Source) with External 24 vdc Supply

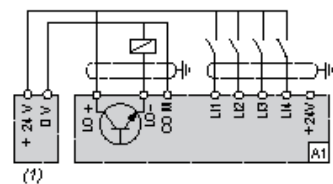

- (1) 24 vdc supply
- A1 : Drive

Connected as Negative Logic (Sink) with External 24 vdc supply

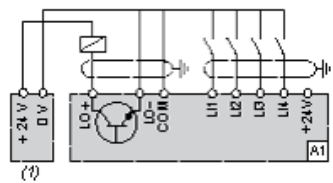

- (1) 24 vdc supply
- A1 : Drive

Torque Curves



- 1 : Self-cooled motor: continuous useful torque (1)
- 2 : Force-cooled motor: continuous useful torque
- 3 : Transient overtorque for 60 s
- 4 : Transient overtorque for 2 s
- 5 : Torque in overspeed at constant power (2)

(1) For power ratings ≤ 250 W, derating is 20% instead of 50% at very low frequencies.

(2) The nominal motor frequency and the maximum output frequency can be adjusted from 0.5 to 400 Hz. The mechanical overspeed capability of the selected motor must be checked with the manufacturer.