



Is Now Part of



ON Semiconductor®

To learn more about ON Semiconductor, please visit our website at
www.onsemi.com

Please note: As part of the Fairchild Semiconductor integration, some of the Fairchild orderable part numbers will need to change in order to meet ON Semiconductor's system requirements. Since the ON Semiconductor product management systems do not have the ability to manage part nomenclature that utilizes an underscore (_), the underscore (_) in the Fairchild part numbers will be changed to a dash (-). This document may contain device numbers with an underscore (_). Please check the ON Semiconductor website to verify the updated device numbers. The most current and up-to-date ordering information can be found at www.onsemi.com. Please email any questions regarding the system integration to Fairchild_questions@onsemi.com.

ON Semiconductor and the ON Semiconductor logo are trademarks of Semiconductor Components Industries, LLC dba ON Semiconductor or its subsidiaries in the United States and/or other countries. ON Semiconductor owns the rights to a number of patents, trademarks, copyrights, trade secrets, and other intellectual property. A listing of ON Semiconductor's product/patent coverage may be accessed at www.onsemi.com/site/pdf/Patent-Marking.pdf. ON Semiconductor reserves the right to make changes without further notice to any products herein. ON Semiconductor makes no warranty, representation or guarantee regarding the suitability of its products for any particular purpose, nor does ON Semiconductor assume any liability arising out of the application or use of any product or circuit, and specifically disclaims any and all liability, including without limitation special, consequential or incidental damages. Buyer is responsible for its products and applications using ON Semiconductor products, including compliance with all laws, regulations and safety requirements or standards, regardless of any support or applications information provided by ON Semiconductor. "Typical" parameters which may be provided in ON Semiconductor data sheets and/or specifications can and do vary in different applications and actual performance may vary over time. All operating parameters, including "Typicals" must be validated for each customer application by customer's technical experts. ON Semiconductor does not convey any license under its patent rights nor the rights of others. ON Semiconductor products are not designed, intended, or authorized for use as a critical component in life support systems or any FDA Class 3 medical devices or medical devices with a same or similar classification in a foreign jurisdiction or any devices intended for implantation in the human body. Should Buyer purchase or use ON Semiconductor products for any such unintended or unauthorized application, Buyer shall indemnify and hold ON Semiconductor and its officers, employees, subsidiaries, affiliates, and distributors harmless against all claims, costs, damages, and expenses, and reasonable attorney fees arising out of, directly or indirectly, any claim of personal injury or death associated with such unintended or unauthorized use, even if such claim alleges that ON Semiconductor was negligent regarding the design or manufacture of the part. ON Semiconductor is an Equal Opportunity/Affirmative Action Employer. This literature is subject to all applicable copyright laws and is not for resale in any manner.



FL77904 Phase-cut Dimmable Compact LED Direct AC Driver

Features

- The simplest Direct AC LED Driver with Only Two External RC Passive Components
- Wide AC Input Range: 90~305 V_{AC}
- Four Integrated High-Voltage LED Constant Current Sinks of up to 75 mA RMS Input Current Capability
- High Power Factor (above 0.98 in normal configuration) Low Harmonic Content (THD under 20% in normal configuration)
- Low Flicker Index by Self Valley Fill with No Degradation of PF and THD
- Adjustable LED Power with an External Current Sense Resistor
- TRIAC Dimmable (Leading/Trailing Edge)
- Rheostat Dimmable Flexible LED Forward Voltage Configuration
- Power Scalability with Multiple Driver ICs
- Over-Temperature Protection (OTP)
- Compact SOIC 8-Lead Package

Description

The FL77904 is a direct AC line LED driver with a minimal number of external RC passive components. In normal configuration, one resistor adjusts LED current for desired system luminance and another bypass capacitor provides a stable voltage to an internal biasing shunt regulator.

The FL77904 provides phase-cut dimming with wide dimming range, smooth dimming control and good dimmer compatibility. Optimized levels of each LED strings' current regulation achieve over 0.98 high PF and less than 20% low THD which makes the FL77904 suitable for high-efficiency LED lighting systems. The FL77904 can be also used with a simple rheostat dimmer switches which are suitable for desktop or indoor lamps.

Flicker index is significantly improved by using proprietary self valley fill technique without degrading PF and THD. The cost effective solution brings low line ripple light quality with system compactness.

Operation of FL77904 admits driving higher-wattage systems, such as street lights and down lights, by simply parallel connecting the driver ICs.

Applications

- General LED Driving Solution for Residential, Commercial and Industrial Lighting

Ordering Information

Part Number	Operating Temperature Range	Package	Packing Method
FL77904MX	-40 to 125°C	8-Lead, Small Outline Integrated Circuit (SOIC) JEDEC MS012 150" Narrow Body, Exposed Pad	2,500 per Reel

Pin Configuration

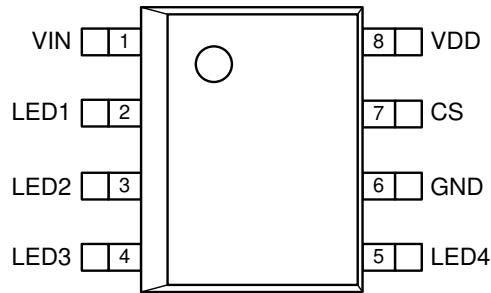

Figure 3. Pin Configuration (Top View)

Thermal Characteristics ^{(1) (2)}

Component	Package	θ_{JA} (1S PCB)	θ_{JA} (2S2P PCB)	Units
FL77904MX	8-Lead, Small Outline Integrated Circuit (SOIC) JEDEC MS012 150" Narrow Body, Exposed Pad	156	37	°C/W

Notes:

- θ_{JA} : Thermal resistance between junction and ambient, dependent on the PCB design, heat sinking, and airflow. The value given is for natural convection with no heatsink using the 1S and 2S2P boards, as specified in JEDEC standards JESD51-2, JESD51-5, and JESD51-7, as appropriate.
- Junction-to-ambient thermal resistance is highly dependent on application and PCB layout. In application where the device dissipates high levels of power during operation, special care of thermal dissipation issues in PCB design must be taken.

Pin Definitions

Pin#	Name	Description
1	VIN	Rectified AC Input Voltage. Connect this pin to rectified AC voltage after a bridge rectifier.
2	LED1	LED String Cathodes. Connect cathode(s) of each LED group to these pins.
3	LED2	
4	LED3	
5	LED4	
6	GND	Ground Reference Pin. Tie this pin directly to local ground plane. This ground should not be tied to earth ground because it is not isolated from AC mains.
7	CS	LED Current Sense. Limits the LED current depending on voltage across sensing resistor. The CS pin is used to set the LED current regulation target.
8	VDD	Internal Biasing Shunt Regulator Output. This pin supplies current to internal circuitry. A 17-V shunt regulator is internally connected to this pin. A bypassing capacitor is recommended to be added to reduce noise from VIN.
0	EP	Exposed Thermal Pad. EP is not tied to GND inside the IC. It is recommended to tie it to GND externally.

Absolute Maximum Ratings

Stresses exceeding the absolute maximum ratings may damage the device. The device may not function or be operable above the recommended operating conditions and stressing the parts to these levels is not recommended. In addition, extended exposure to stresses above the recommended operating conditions may affect device reliability. The absolute maximum ratings are stress ratings only.

Symbol	Parameter	Min.	Max.	Unit
V _{IN}	VIN Voltage	-0.3	500	V
V _{LED1}	LED1 Pin Voltage	-0.3	500	V
V _{LED2}	LED2 Pin Voltage	-0.3	500	V
V _{LED3}	LED3 Pin Voltage	-0.3	500	V
V _{LED4}	LED4 Pin Voltage	-0.3	200	V
V _{CS}	CS Pin Voltage	-0.3	6	V
T _J	Junction Temperature	-55	+150	°C
T _{STG}	Storage Temperature	-65	+150	°C
I _{LED1}	LED1 Current		60	mA
I _{LED2}	LED2 Current		80	mA
I _{LED3}	LED3 Current		100	mA
I _{LED4}	LED4 Current		150	mA

Notes:

- Stress beyond those listed under Absolute Maximum Ratings may cause permanent damage to the device.
- All voltage values, except differential voltages, are given with respect to the GND pin.
- Human Body Model, ANSI/ESDA/JEDEC JS-001-2012: 0.8 kV at Pins 1~4, 0.4 kV at Pin 5, 1.5 kV at Pins 7~8.
- Charged Device Model, JESD22-C101: 1.0 kV at Pins 1~8.

Recommended Operating Conditions

The Recommended Operating Conditions table defines the conditions for actual device operation. Recommended operating conditions are specified to ensure optimal performance to the datasheet specifications. Fairchild does not recommend exceeding them or designing to Absolute Maximum Ratings.

Symbol	Parameter	Min.	Max.	Unit
T _J	Operating Junction Temperature	-40	+125	°C

Electrical Characteristics

Unless otherwise noted, $R_{CS} = 10 \Omega$, and $T_A = 25^\circ\text{C}$. Currents are defined as positive into the device and negative out of the device.

Symbol	Parameter	Conditions	Min.	Typ.	Max.	Unit
VIN Supply						
$I_{\text{QUIES.VIN}}$	V_{IN} Quiescent Current	$V_{\text{IN}} = 500 \text{ V}$ Maximum		0.75	1.20	mA
VDD Output						
V_{DD}	VDD Voltage	$V_{\text{IN}} = 20.0 \text{ V}$	16	17	18	V
LED Current						
I_{LED1}	LED1 Current	$V_{\text{IN}} = 20.0 \text{ V}$, $V_{\text{LED1}} = 20.0 \text{ V}$	17.4	23.0	28.6	mA
I_{LED2}	LED2 Current	$V_{\text{IN}} = 20.0 \text{ V}$, $V_{\text{LED2}} = 20.0 \text{ V}$	40.4	47.0	53.6	mA
I_{LED3}	LED3 Current	$V_{\text{IN}} = 20.0 \text{ V}$, $V_{\text{LED3}} = 35.0 \text{ V}$	78.2	86.0	93.8	mA
I_{LED4}	LED4 Current	$V_{\text{IN}} = 20.0 \text{ V}$, $V_{\text{LED4}} = 20.0 \text{ V}$	87.8	96.0	104.2	mA
Over-Temperature Protection						
T_{OTP}	OTP Temperature ⁽⁷⁾			170		$^\circ\text{C}$
Leakage Current						
$I_{\text{LED1-LK}}$	LED1 Leakage Current	$V_{\text{LED1}} = 500 \text{ V}$, $V_{\text{IN}} = 0 \text{ V}$			1	μA
$I_{\text{LED2-LK}}$	LED2 Leakage Current	$V_{\text{LED2}} = 500 \text{ V}$, $V_{\text{IN}} = 0 \text{ V}$			1	μA
$I_{\text{LED3-LK}}$	LED3 Leakage Current	$V_{\text{LED3}} = 500 \text{ V}$, $V_{\text{IN}} = 0 \text{ V}$			1	μA
$I_{\text{LED4-LK}}$	LED4 Leakage Current	$V_{\text{LED4}} = 200 \text{ V}$, $V_{\text{IN}} = 0 \text{ V}$			1	μA

Notes:

- Not tested in production. Internal over-temperature protection circuitry protects the device from permanent damage. LEDs shut down at the junction temperature of $T_J = 170^\circ\text{C}$ (typical.).

Typical Performance Characteristics

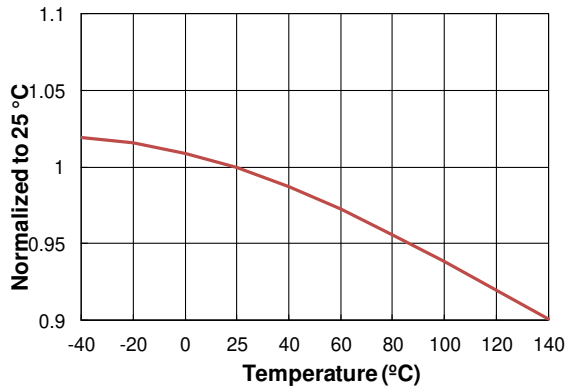

Figure 4. $I_{Q_{UIES,VIN}}$ vs. Temperature

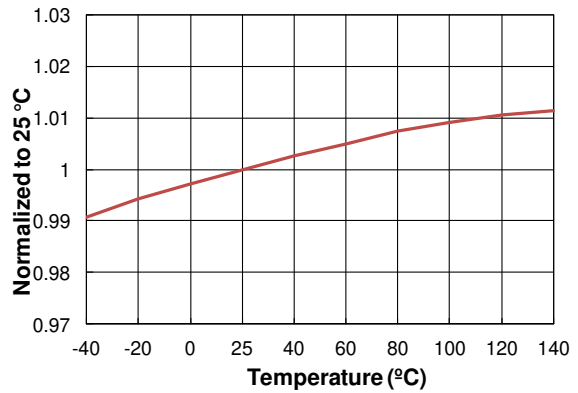

Figure 5. V_{DD} vs. Temperature

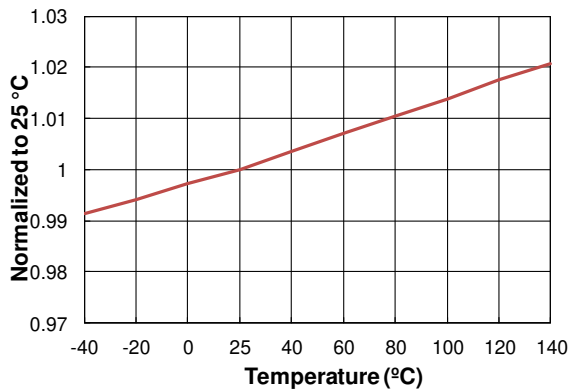

Figure 6. I_{LED1} vs. Temperature

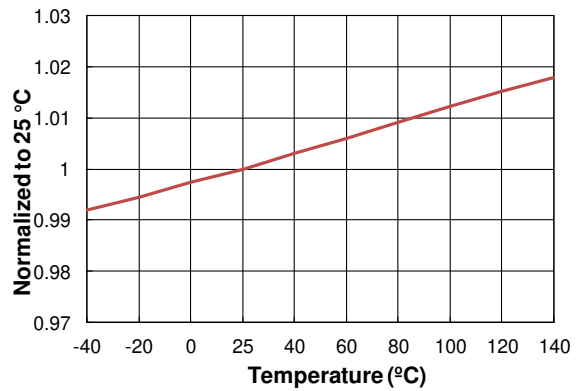

Figure 7. I_{LED2} vs. Temperature

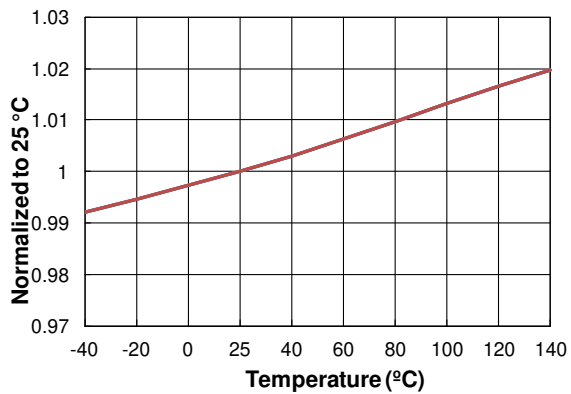

Figure 8. I_{LED3} vs. Temperature

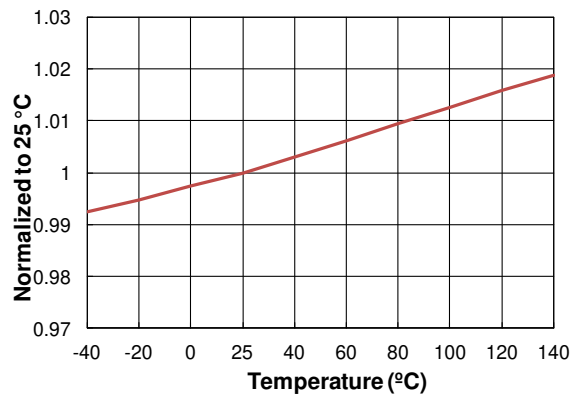

Figure 9. I_{LED4} vs. Temperature

Functional Description

The FL77904 can drive LED strings attached directly to the rectified AC mains using only two external RC components (R_{CS} and C_{VDD}). With 4 integrated high voltage current sink, LED current in each string is precisely controlled with system compactness. High PF and low THD are obtained by the optimized current sink levels. Phase-cut dimming is easily obtained with wide dimming range and good dimmer compatibility. Flicker index in the direct AC drive topology can be improved by adopting proprietary self valley-fill solution.

Operation

When the rectified AC line voltage, V_{IN} , is higher than the forward voltage of the consecutive LED groups, each LED group turns on automatically as the corresponding current sink has enough voltage headroom across it. Each current sink increases up to the predefined current level and maintains the level until the following channel current sink gets enough voltage headroom across it.

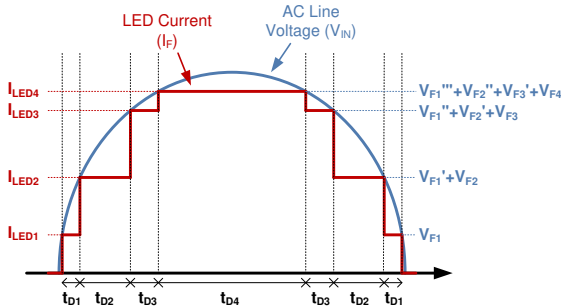

- t_{D1} : Current is directed to LED1 pin through 1st LED group.
- t_{D2} : Current is directed to LED2 pin through 1st and 2nd LED groups.
- t_{D3} : Current is directed to LED3 pin through 1st, 2nd, and 3rd LED groups.
- t_{D4} : Current is directed to LED4 pin through 1st, 2nd, 3rd, and 4th LED groups.
- $V_{F1}/V_{F1}'/V_{F1}''/V_{F1}'''$: Forward voltage at forward current of $I_{LED1}/I_{LED2}/I_{LED3}/I_{LED4}$ in 1st LED group.
- $V_{F2}/V_{F2}'/V_{F2}''$: Forward voltage at forward current of $I_{LED2}/I_{LED3}/I_{LED4}$ in 2nd LED group.
- V_{F3}/V_{F3}' : Forward voltage at forward current of I_{LED3}/I_{LED4} in 3rd LED group.
- V_{F4} : Forward voltage at forward current of I_{LED4} in 4th LED group.

Figure 10. FL77904 Operation

When V_{IN} reaches the forward voltage across the 1st LED group (V_{F1}) at forward current $I_F = I_{LED1}$, the current drawn from the V_{IN} is directed to the LED1 through the 1st LED group. In sequence, when V_{IN} reaches forward voltage across the 1st and 2nd LED groups ($V_{F1}'+V_{F2}$) at $I_F = I_{LED2}$, the current is directed to LED2 across the 1st and 2nd LED groups. Then, when V_{IN} reaches $V_{F1}''+V_{F2}'+V_{F3}$ at $I_F = I_{LED3}$, the LED current go through 1st, 2nd, and 3rd LED groups and sinks to the LED3. Finally, when V_{IN} reaches $V_{F1}''' + V_{F2}'' + V_{F3}' + V_{F4}$ at $I_F = I_{LED4}$, the current goes through all 4 LED groups and is directed to the LED4.

Whenever the active channel (one that is sinking LED current) is changed from one channel to the adjacent channel with respect to the change in the V_{IN} , the new active channel's current increases gradually while the existing active channel's current decreases gradually. This smooth current transition reduces frequency

harmonic contents and improves power factor as well as Electromagnetic Interference (EMI) characteristics.

By fully utilizing available headroom, the FL77904 offers high efficiency, power factor and low harmonic distortion. Typically, power factor is higher than 0.98 and THD is lower than 20%. The efficiency heavily depends on a LED configuration.

LED Current and Power Setting

The LED current is managed by an external current sense resistor R_{CS} . Regulation target of each channel's current sink is calculated as follows.

$$I_{LED1} = \frac{0.23}{R_{CS}}, I_{LED2} = \frac{0.47}{R_{CS}},$$

$$I_{LED3} = \frac{0.86}{R_{CS}}, \text{ and } I_{LED4} = \frac{0.96}{R_{CS}}. \quad (1)$$

Root-mean-square (RMS) value of the input current can be calculated using the peak regulated current, I_{LED4} , and crest factor. Since the LED current waveform is similar to the AC line voltage, the crest factor is close to the crest factor of a sine wave, $\sqrt{2}=1.414$. But the actual crest factor depends on the flattened time of the I_{LED4} and LED configuration. With FL77904, the typical crest factor is approximately 1.35. Thus, based on estimated input power, P_{IN} , the R_{CS} resistor value can be calculated as follows.

$$R_{CS} = \frac{0.96 \times V_{AC.RMS}}{1.35 \times P_{IN}} \quad (2)$$

The actual R_{CS} needs to be adjusted with respect to the LED configuration.

LED Configuration

In the LED configuration, it is required to increase the total LED forward voltage to improve efficiency. For example, compared to using 4 LEDs with V_F of 60 V (total $V_F = 60 \text{ V} \times 4 \text{ channels} = 240 \text{ V}$) for each LED group, using 4 LEDs with V_F equal to 65 V (total $V_F = 65 \text{ V} \times 4 \text{ channels} = 260 \text{ V}$) will improve the efficiency simply due to the higher total V_F . Each LED channel can have different V_F . For example, if a design is implemented with 144 pieces of 3-V LEDs for replacement of 2-foot fluorescent lamp, designer can assign flexible numbers of LEDs for LED channels such as 25s2p-32s2p-6s2p-18s1p ("s" stands for LEDs in series and "p" stands for LEDs in parallel) or 18s2p-18s2p-18s2p-36s1p.

In any LED structure, V_F of first LED group should be higher than V_{IN} -pin turn-on voltage, which is 20 V. If the V_F of the first LED group is configured to be lower than V_{IN} -pin turn-on voltage, I_{LED1} will not have the correct regulation level when input voltage, V_{IN} , is just exceeds the V_F .

A good starting point for choosing a LED configuration is to have about 260 V~280 V of the total V_F for 220 V_{AC} mains and 130 V~140 V of the total V_F for 120 V_{AC}.

Internal Shunt Regulator Output, V_{DD}

The system implemented with FL77904 does not require a bulk capacitor after bridge-rectification diodes. As a result, the V_{DD} , which supplies biasing voltage for the FL77904, has voltage ripple like the rectification voltage after the bridge diodes as shown in Figure 11.

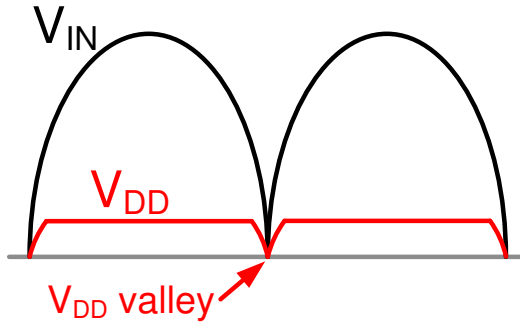
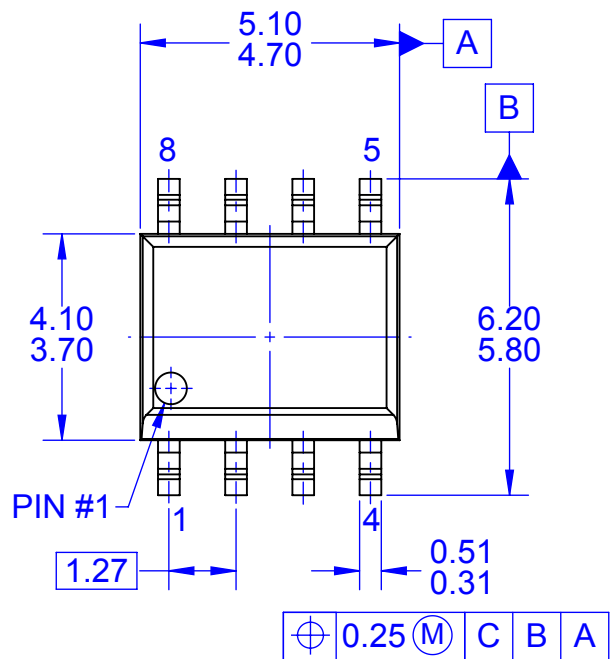

Figure 11. V_{DD} Ripple without C_{VDD}

The V_{DD} ripple can be reduced by a bypassing capacitor, C_{VDD} . If the C_{VDD} is not used, or its value is small, the V_{DD} voltage fluctuates and goes even down to 0 V. It makes the FL77904 reset, but the FL77904 automatically restarts every cycle when the AC line voltage reaches a certain level. General design suggestion is to add C_{VDD} for noise filtering. The recommended C_{VDD} value is 1 μ F with 50 V of voltage rating.

Over-Temperature Protection (OTP)

The FL77904 provides over temperature protection (OTP) inherently. When the driver's junction temperature exceeds a specified threshold temperature ($T_J = 170^\circ\text{C}$), the driver will shut down automatically and recover once the temperature drops lower enough than the internal threshold temperature. Without this protection, the lifetime of the FL77904 can be reduced and irreparable damage can occur. Good thermal management is required to achieve best performance and long life span of the FL77904.



TOP VIEW

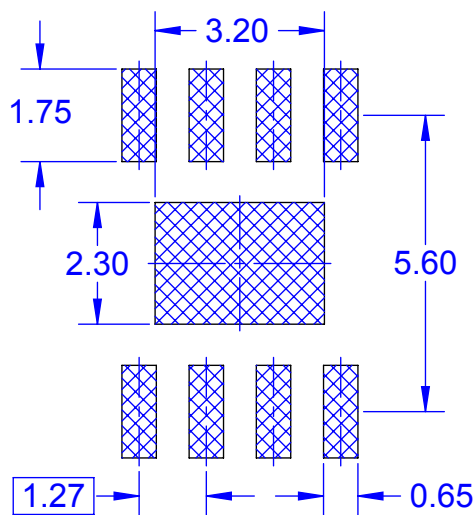

LAND PATTERN RECOMMENDATION

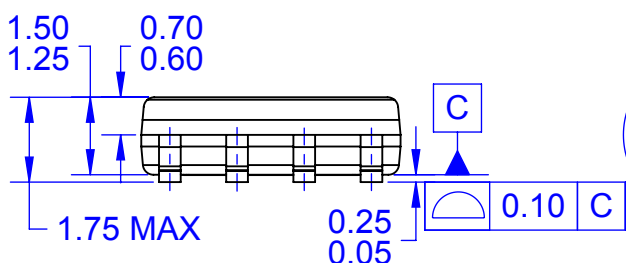

FRONT VIEW

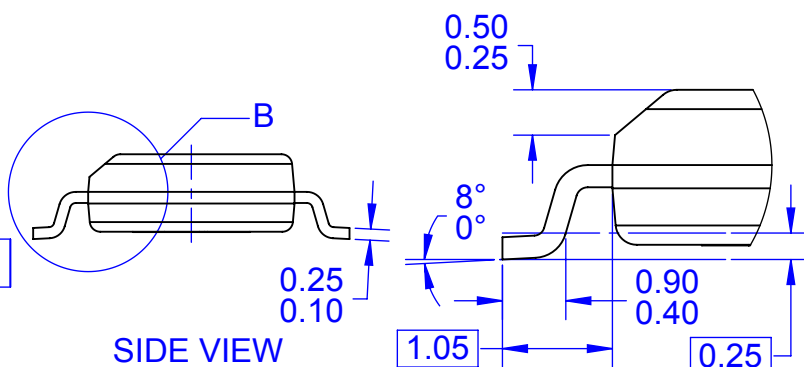

SIDE VIEW

DETAIL B
SCALE 2:1

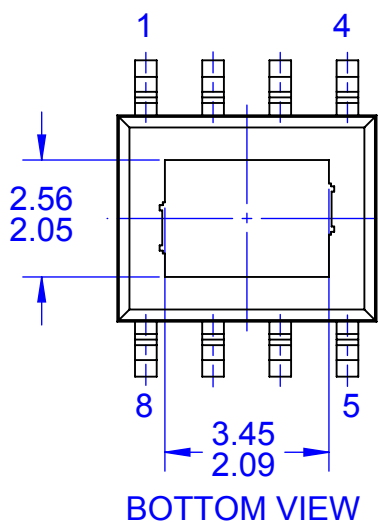

BOTTOM VIEW

NOTES:

- A. NO INDUSTRY STANDARD APPLIES TO THIS PACKAGE
- B. ALL DIMENSIONS ARE IN MILLIMETERS
- C. DIMENSIONS DO NOT INCLUDE MOLD FLASH OR BURRS
- D. DRAWING FILENAME: MKT-M08Frev2



ON Semiconductor and  are trademarks of Semiconductor Components Industries, LLC dba ON Semiconductor or its subsidiaries in the United States and/or other countries. ON Semiconductor owns the rights to a number of patents, trademarks, copyrights, trade secrets, and other intellectual property. A listing of ON Semiconductor's product/patent coverage may be accessed at www.onsemi.com/site/pdf/Patent-Marking.pdf. ON Semiconductor reserves the right to make changes without further notice to any products herein. ON Semiconductor makes no warranty, representation or guarantee regarding the suitability of its products for any particular purpose, nor does ON Semiconductor assume any liability arising out of the application or use of any product or circuit, and specifically disclaims any and all liability, including without limitation special, consequential or incidental damages. Buyer is responsible for its products and applications using ON Semiconductor products, including compliance with all laws, regulations and safety requirements or standards, regardless of any support or applications information provided by ON Semiconductor. "Typical" parameters which may be provided in ON Semiconductor data sheets and/or specifications can and do vary in different applications and actual performance may vary over time. All operating parameters, including "Typicals" must be validated for each customer application by customer's technical experts. ON Semiconductor does not convey any license under its patent rights nor the rights of others. ON Semiconductor products are not designed, intended, or authorized for use as a critical component in life support systems or any FDA Class 3 medical devices or medical devices with a same or similar classification in a foreign jurisdiction or any devices intended for implantation in the human body. Should Buyer purchase or use ON Semiconductor products for any such unintended or unauthorized application, Buyer shall indemnify and hold ON Semiconductor and its officers, employees, subsidiaries, affiliates, and distributors harmless against all claims, costs, damages, and expenses, and reasonable attorney fees arising out of, directly or indirectly, any claim of personal injury or death associated with such unintended or unauthorized use, even if such claim alleges that ON Semiconductor was negligent regarding the design or manufacture of the part. ON Semiconductor is an Equal Opportunity/Affirmative Action Employer. This literature is subject to all applicable copyright laws and is not for resale in any manner.

PUBLICATION ORDERING INFORMATION

LITERATURE FULFILLMENT:

Literature Distribution Center for ON Semiconductor
19521 E. 32nd Pkwy, Aurora, Colorado 80011 USA
Phone: 303-675-2175 or 800-344-3860 Toll Free USA/Canada
Fax: 303-675-2176 or 800-344-3867 Toll Free USA/Canada
Email: orderlit@onsemi.com

N. American Technical Support: 800-282-9855 Toll Free
USA/Canada
Europe, Middle East and Africa Technical Support:
Phone: 421 33 790 2910
Japan Customer Focus Center
Phone: 81-3-5817-1050

ON Semiconductor Website: www.onsemi.com
Order Literature: <http://www.onsemi.com/orderlit>
For additional information, please contact your local
Sales Representative