



**MICROCHIP**

---

**PIC32MZ DA Family Starter Kit  
User's Guide**

---

**Note the following details of the code protection feature on Microchip devices:**

- Microchip products meet the specification contained in their particular Microchip Data Sheet.
- Microchip believes that its family of products is one of the most secure families of its kind on the market today, when used in the intended manner and under normal conditions.
- There are dishonest and possibly illegal methods used to breach the code protection feature. All of these methods, to our knowledge, require using the Microchip products in a manner outside the operating specifications contained in Microchip's Data Sheets. Most likely, the person doing so is engaged in theft of intellectual property.
- Microchip is willing to work with the customer who is concerned about the integrity of their code.
- Neither Microchip nor any other semiconductor manufacturer can guarantee the security of their code. Code protection does not mean that we are guaranteeing the product as "unbreakable."

Code protection is constantly evolving. We at Microchip are committed to continuously improving the code protection features of our products. Attempts to break Microchip's code protection feature may be a violation of the Digital Millennium Copyright Act. If such acts allow unauthorized access to your software or other copyrighted work, you may have a right to sue for relief under that Act.

---

Information contained in this publication regarding device applications and the like is provided only for your convenience and may be superseded by updates. It is your responsibility to ensure that your application meets with your specifications. MICROCHIP MAKES NO REPRESENTATIONS OR WARRANTIES OF ANY KIND WHETHER EXPRESS OR IMPLIED, WRITTEN OR ORAL, STATUTORY OR OTHERWISE, RELATED TO THE INFORMATION, INCLUDING BUT NOT LIMITED TO ITS CONDITION, QUALITY, PERFORMANCE, MERCHANTABILITY OR FITNESS FOR PURPOSE. Microchip disclaims all liability arising from this information and its use. Use of Microchip devices in life support and/or safety applications is entirely at the buyer's risk, and the buyer agrees to defend, indemnify and hold harmless Microchip from any and all damages, claims, suits, or expenses resulting from such use. No licenses are conveyed, implicitly or otherwise, under any Microchip intellectual property rights unless otherwise stated.

*Microchip received ISO/TS-16949:2009 certification for its worldwide headquarters, design and wafer fabrication facilities in Chandler and Tempe, Arizona; Gresham, Oregon and design centers in California and India. The Company's quality system processes and procedures are for its PIC® MCUs and dsPIC® DSCs, KEELOQ® code hopping devices, Serial EEPROMs, microperipherals, nonvolatile memory and analog products. In addition, Microchip's quality system for the design and manufacture of development systems is ISO 9001:2000 certified.*

**QUALITY MANAGEMENT SYSTEM  
CERTIFIED BY DNV  
= ISO/TS 16949 =**

**Trademarks**

The Microchip name and logo, the Microchip logo, AnyRate, AVR, AVR logo, AVR Freaks, BeaconThings, BitCloud, CryptoMemory, CryptoRF, dsPIC, FlashFlex, flexPWR, Heldo, JukeBlox, KEELOQ, KEELOQ logo, Kleer, LANCheck, LINK MD, maXStylus, maXTouch, MediaLB, megaAVR, MOST, MOST logo, MPLAB, OptoLyzer, PIC, picoPower, PICSTART, PIC32 logo, Prochip Designer, QTouch, RightTouch, SAM-BA, SpyNIC, SST, SST Logo, SuperFlash, tinyAVR, UNI/O, and XMEGA are registered trademarks of Microchip Technology Incorporated in the U.S.A. and other countries.

ClockWorks, The Embedded Control Solutions Company, EtherSynch, Hyper Speed Control, HyperLight Load, IntelliMOS, mTouch, Precision Edge, and Quiet-Wire are registered trademarks of Microchip Technology Incorporated in the U.S.A.

Adjacent Key Suppression, AKS, Analog-for-the-Digital Age, Any Capacitor, AnyIn, AnyOut, BodyCom, chipKIT, chipKIT logo, CodeGuard, CryptoAuthentication, CryptoCompanion, CryptoController, dsPICDEM, dsPICDEM.net, Dynamic Average Matching, DAM, ECAN, EtherGREEN, In-Circuit Serial Programming, ICSP, Inter-Chip Connectivity, JitterBlocker, KleerNet, KleerNet logo, Mindi, MiWi, motorBench, MPASM, MPF, MPLAB Certified logo, MPLIB, MPLINK, MultiTRAK, NetDetach, Omniscient Code Generation, PICDEM, PICDEM.net, PICKit, PICtail, PureSilicon, QMatrix, RightTouch logo, REAL ICE, Ripple Blocker, SAM-ICE, Serial Quad I/O, SMART-I.S., SQI, SuperSwitcher, SuperSwitcher II, Total Endurance, TSHARC, USBCheck, VariSense, ViewSpan, WiperLock, Wireless DNA, and ZENA are trademarks of Microchip Technology Incorporated in the U.S.A. and other countries.

SQTP is a service mark of Microchip Technology Incorporated in the U.S.A.

Silicon Storage Technology is a registered trademark of Microchip Technology Inc. in other countries.

GestIC is a registered trademark of Microchip Technology Germany II GmbH & Co. KG, a subsidiary of Microchip Technology Inc., in other countries.

All other trademarks mentioned herein are property of their respective companies.

© 2017, Microchip Technology Incorporated, All Rights Reserved.

ISBN: 978-1-5224-1679-1

## Object of Declaration: PIC32MZ DA Family Starter Kit User's Guide

### EU Declaration of Conformity

This declaration of conformity is issued by the manufacturer.

The development/evaluation tool is designed to be used for research and development in a laboratory environment. This development/evaluation tool is not a Finished Appliance, nor is it intended for incorporation into Finished Appliances that are made commercially available as single functional units to end users under EU EMC Directive 2004/108/EC and as supported by the European Commission's Guide for the EMC Directive 2004/108/EC (8th February 2010).

This development/evaluation tool complies with EU RoHS2 Directive 2011/65/EU.

This development/evaluation tool, when incorporating wireless and radio-telecom functionality, is in compliance with the essential requirement and other relevant provisions of the R&TTE Directive 1999/5/EC and the FCC rules as stated in the declaration of conformity provided in the module datasheet and the module product page available at [www.microchip.com](http://www.microchip.com).

For information regarding the exclusive, limited warranties applicable to Microchip products, please see Microchip's standard terms and conditions of sale, which are printed on our sales documentation and available at [www.microchip.com](http://www.microchip.com).

Signed for and on behalf of Microchip Technology Inc. at Chandler, Arizona, USA.

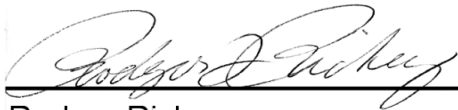

Rodger Richey  
Director of Development Tools



Date

# PIC32MZ DA Family Starter Kit User's Guide

---

NOTES:



# PIC32MZ DA FAMILY STARTER KIT USER'S GUIDE

---

---

## Table of Contents

---

---

<b>Preface</b> .....	<b>7</b>
<b>Chapter 1. Introduction</b>	
1.1 Kit Contents .....	14
1.2 Block Diagram .....	14
1.3 Starter Kit Functionality and Features .....	15
<b>Chapter 2. Hardware</b>	
2.1 Hardware Features .....	23
<b>Appendix A. Schematics</b>	
A.1 Schematics .....	27
<b>Appendix B. Bill of Materials</b>	
B.1 PIC32MZ2064DAx288 Daughter Card Bill of Materials .....	41
B.2 PIC32MZ2064DAx169 Daughter Card Bill of Materials .....	43
B.3 PIC32MZ DA SK Base Board Bill of Materials .....	44
B.4 LAN8740A PHY Daughter Board Bill of Materials .....	47
<b>Worldwide Sales and Service</b> .....	<b>48</b>

# PIC32MZ DA Family Starter Kit User's Guide

---

NOTES:



# PIC32MZ DA FAMILY STARTER KIT USER'S GUIDE

## Preface

### NOTICE TO CUSTOMERS

All documentation becomes dated, and this manual is no exception. Microchip tools and documentation are constantly evolving to meet customer needs, so some actual dialogs and/or tool descriptions may differ from those in this document. Please refer to our web site ([www.microchip.com](http://www.microchip.com)) to obtain the latest documentation available.

Documents are identified with a “DS” number. This number is located on the bottom of each page, in front of the page number. The numbering convention for the DS number is “DSXXXXXXXXA”, where “XXXXXXXX” is the document number and “A” is the revision level of the document.

For the most up-to-date information on development tools, see the MPLAB® X IDE online help. Select the Help menu, and then Topics to open a list of available online help files.

## INTRODUCTION

This chapter contains general information that will be useful to know before using the PIC32MZ DA Family Starter Kit. Items discussed in this chapter include:

- [Document Layout](#)
- [Conventions Used in this Guide](#)
- [Recommended Reading](#)
- [The Microchip Web Site](#)
- [Development Systems Customer Change Notification Service](#)
- [Customer Support](#)
- [Document Revision History](#)

## DOCUMENT LAYOUT

This document describes how to use the PIC32MZ DA Family Starter Kit (also referred to as “starter kit”) as a development tool to emulate and debug firmware on a target board. This user’s guide is composed of the following chapters:

- **Chapter 1. “Introduction”** provides a brief overview of the starter kit, highlighting its features and uses.
- **Chapter 2. “Hardware”** provides the hardware descriptions of the starter kit.
- **Appendix A. “Schematics”** provides a block diagram, board layouts, and detailed schematics of the starter kit.
- **Appendix B. “Bill of Materials”** provides the bill of materials for the components used in the design and manufacture of the starter kit.

# PIC32MZ DA Family Starter Kit User's Guide

## CONVENTIONS USED IN THIS GUIDE

This manual uses the following documentation conventions:

### DOCUMENTATION CONVENTIONS

Description	Represents	Examples
Italic characters	Referenced books	<i>MPLAB X IDE User's Guide</i>
	Emphasized text	...is the <i>only</i> compiler...
Initial caps	A window	the Output window
	A dialog	the Settings dialog
	A menu selection	select Enable Programmer
Quotes	A field name in a window or dialog	"Save project before build"
Underlined, italic text with right angle bracket	A menu path	<u><i>File &gt; Save</i></u>
Bold characters	A dialog button	Click <b>OK</b>
	A tab	Click the <b>Power</b> tab
Text in angle brackets < >	A key on the keyboard	Press <Enter>, <F1>
Plain Courier New	Sample source code	#define START
	Filenames	autoexec.bat
	File paths	c:\mcc18\h
	Keywords	_asm, _endasm, static
	Command-line options	-Opa+, -Opa-
	Bit values	0, 1
	Constants	0xFF, 'A'
<i>Italic Courier New</i>	A variable argument	<i>file.o</i> , where <i>file</i> can be any valid filename
Square brackets [ ]	Optional arguments	mcc18 [options] <i>file</i> [options]
Curly brackets and pipe character: {   }	Choice of mutually exclusive arguments; an OR selection	errorlevel {0 1}
Ellipses...	Replaces repeated text	var_name [, var_name...]
	Represents code supplied by user	void main (void) { ... }
Notes	A Note presents information that we want to re-emphasize, either to help you avoid a common pitfall or to make you aware of operating differences between some device family members. A Note can be in a box, or when used in a table or figure, it is located at the bottom of the table or figure.	<b>Note:</b> This is a standard note box.
		<b>CAUTION</b> <b>This is a caution note.</b> <b>Note 1:</b> This is a note used in a table.



## RECOMMENDED READING

This user's guide describes how to use the PIC32MZ DA Family Starter Kit. The following Microchip documents are available and recommended as supplemental reference resources.

### **PIC32MZ Graphics DA Family Data Sheet (DS60001361)**

Refer to this document for detailed information on PIC32MZ DA family of devices. Reference information found in this data sheet includes:

- Device memory maps
- Device pinout and packaging details
- Device electrical specifications
- List of peripherals included on the devices

### **MPLAB® XC32 C/C++ Compiler User's Guide (DS50001686)**

This document details the use of Microchip's MPLAB XC32 C/C++ compiler to develop an application.

### **MPLAB® X IDE User's Guide (DS50002027)**

Refer to this document for more information pertaining to the installation and implementation of the MPLAB X IDE software, as well as the MPLAB SIM Simulator software that is included with it.

### **Universal Serial Bus Specification and Associated Documents**

The Universal Serial Bus is defined by the USB 2.0 specification and its associated supplements and class-specific documents. These documents are available from the USB Implementers Forum, see their web site at: <http://www.usb.org>.

## THE MICROCHIP WEB SITE

Microchip provides online support via our web site at <http://www.microchip.com>. This web site makes files and information easily available to customers. Accessible by most Internet browsers, the web site contains the following information:

- **Product Support** – Data sheets and errata, application notes and sample programs, design resources, user's guides and hardware support documents, latest software releases and archived software
- **General Technical Support** – Frequently Asked Questions (FAQs), technical support requests, online discussion groups, Microchip consultant program member listings
- **Business of Microchip** – Product selector and ordering guides, latest Microchip press releases, listings of seminars and events; and listings of Microchip sales offices, distributors and factory representatives

# PIC32MZ DA Family Starter Kit User's Guide

---

## DEVELOPMENT SYSTEMS CUSTOMER CHANGE NOTIFICATION SERVICE

Microchip's customer notification service helps keep customers current on Microchip products. Subscribers will receive e-mail notification whenever there are changes, updates, revisions or errata related to a specified product family or development tool of interest.

To register, access the Microchip web site at [www.microchip.com](http://www.microchip.com), click on Customer Change Notification and follow the registration instructions.

The Development Systems product group categories are:

- **Compilers** – The latest information on Microchip C compilers and other language tools
- **Emulators** – The latest information on the Microchip in-circuit emulator, MPLAB REAL ICE™
- **In-Circuit Debuggers** – The latest information on the Microchip in-circuit debugger, MPLAB ICD 3
- **MPLAB X IDE** – The latest information on Microchip MPLAB X IDE, the Windows® Integrated Development Environment for development systems tools
- **Programmiers** – The latest information on Microchip programmers including the PICkit™ 3 development programmer

## CUSTOMER SUPPORT

Users of Microchip products can receive assistance through several channels:

- Distributor or Representative
- Local Sales Office
- Field Application Engineer (FAE)
- Technical Support

Customers should contact their distributor, representative or field application engineer (FAE) for support. Local sales offices are also available to help customers. A listing of sales offices and locations is included in the back of this document.

Technical support is available through the web site at: <http://support.microchip.com>.

## DOCUMENT REVISION HISTORY

### **Revision A (May 2017)**

This is the initial released version of this user's guide.

# PIC32MZ DA Family Starter Kit User's Guide

---

NOTES:



# PIC32MZ DA FAMILY STARTER KIT USER'S GUIDE

---

---

## Chapter 1. Introduction

---

---

Thank you for purchasing a Microchip Technology PIC32MZ DA Family Starter Kit. This starter kit provides a low-cost modular development system for Microchip's line of 32-bit microcontrollers.

The starter kit is available in four versions:

- PIC32MZ Embedded Graphics with External DRAM (DA) Starter Kit (P/N: DM320008)
- PIC32MZ Embedded Graphics with External DRAM (DA) Starter Kit (Crypto) (P/N: DM320008-C)
- PIC32MZ Embedded Graphics with Stacked DRAM (DA) Starter Kit (P/N: DM320010)
- PIC32MZ Embedded Graphics with Stacked DRAM (DA) Starter Kit (Crypto) (P/N: DM320010-C)

The four versions of the starter kit which are facilitated through a common base board (referred to as PIC32MZ DA SK Base Board) and four different CPU Daughter Cards (referred to as PIC32MZ2064DAx288 Daughter Card and PIC32MZ2064DAx169 Daughter Card) are given below:

- DM320008 comes with PIC32MZ2064DAA288 Daughter Card
- DM320008-C comes with PIC32MZ2064DAB288 Daughter Card
- DM320010 comes with PIC32MZ2064DAG169 Daughter Card
- DM320010-C has PIC32MZ2064DAH169 Daughter Card

Any configuration of the PIC32 Embedded Graphics Starter Kit can be used in conjunction with Multimedia Expansion Board II (MEB-II) at <http://www.microchip.com/meb2> to exercise the embedded graphics features.

For a free Microchip demonstration code and additional information, please visit the MPLAB Harmony page at: <http://www.microchip.com/MPLABHarmony>.

The MPLAB Harmony Integrated Software Framework includes several demonstrations that have configurations for the PIC32MZ DA Starter Kit. These demonstrations are available in the <install-dir>/apps folder of the MPLAB Harmony installation, where <install-dir> is either C:/microchip/harmony/<version> (for Windows OS) or ~/microchip/harmony/<version> (for MAC or Linux OS).

For additional information on demonstrations and building/running steps, refer to the documents available in the <install-dir>/doc folder.

This chapter covers the following topics:

- [Kit Contents](#)
- [Starter Kit Functionality and Features](#)

# PIC32MZ DA Family Starter Kit User's Guide

## 1.1 KIT CONTENTS

The PIC32MZ DA Starter Kit contains the following items:

- One PIC32MZ Embedded Graphics (DA) Starter Kit
- One LAN8740A Ethernet PHY Daughter Board
- One Type-A male to Micro-B USB cable (to communicate with the PIC32 DEBUG port)
- One ETH cable
- Information sheet

**Note:** If you are missing any part of the kit, contact a Microchip sales office for assistance. A list of Microchip offices for sales and service is provided on the last page of this document.

## 1.2 BLOCK DIAGRAM

Figure 1-1 illustrates the high-level block diagram of the PIC32MZ DA Starter Kit.

**FIGURE 1-1: HIGH-LEVEL BLOCK DIAGRAM OF THE PIC32MZ DA STARTER KIT**

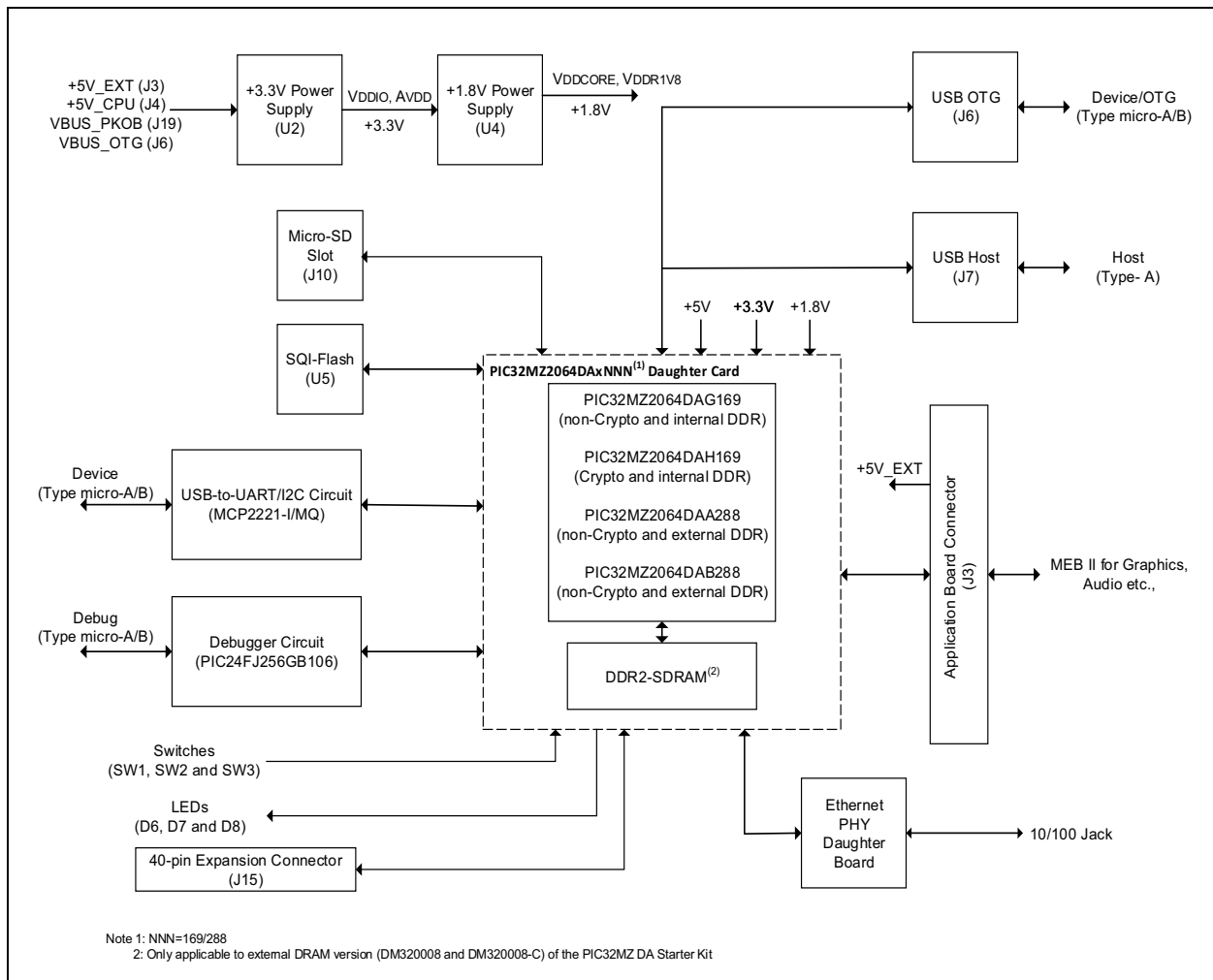

## 1.3 STARTER KIT FUNCTIONALITY AND FEATURES

### 1.3.1 Development Board

Representations of the layout of the development board included in the PIC32MZ DA Family Starter Kit are shown in [Figure 1-2](#) through [Figure 1-7](#).

The top assembly of the PIC32MZ DA SK Base Board includes these key features, as indicated in [Figure 1-2](#).

1. USB Micro-B power supply connector (J4).
2. Headers to connect PIC32MZ2064DAx288/PIC32MZ2064DAx169 CPU Daughter Cards (J2, J3).
3. Micro-SD slot (J10).
4. Headers for flexible Ethernet PHY options (J9).
5. USB Type-A connector for PIC32 USB host based applications (J7).
6. USB Micro-B connector for USB-to-UART communication (J5).
7. Three push button switches for user-defined inputs (S1, S2, and S3).
8. Three user-defined indicator LEDs (D3, D4, and D5).
9. Jumper for using or disconnecting the on-board debugger (J17).
10. Connector for an external debugger, such as MPLAB<sup>®</sup> REAL ICE or MPLAB ICD 3 (J12).
11. 40-pin expansion connector for adding external boards (J15).

**Note:** When running self-powered USB device applications, open the jumper JP1 to prevent possibly back-feeding voltage onto the VBUS from one port on the host to another (or from one host to another).

For details on these features, refer to [Chapter 2. “Hardware”](#).

**FIGURE 1-2: PIC32MZ DA SK BASE BOARD LAYOUT (TOP VIEW)**

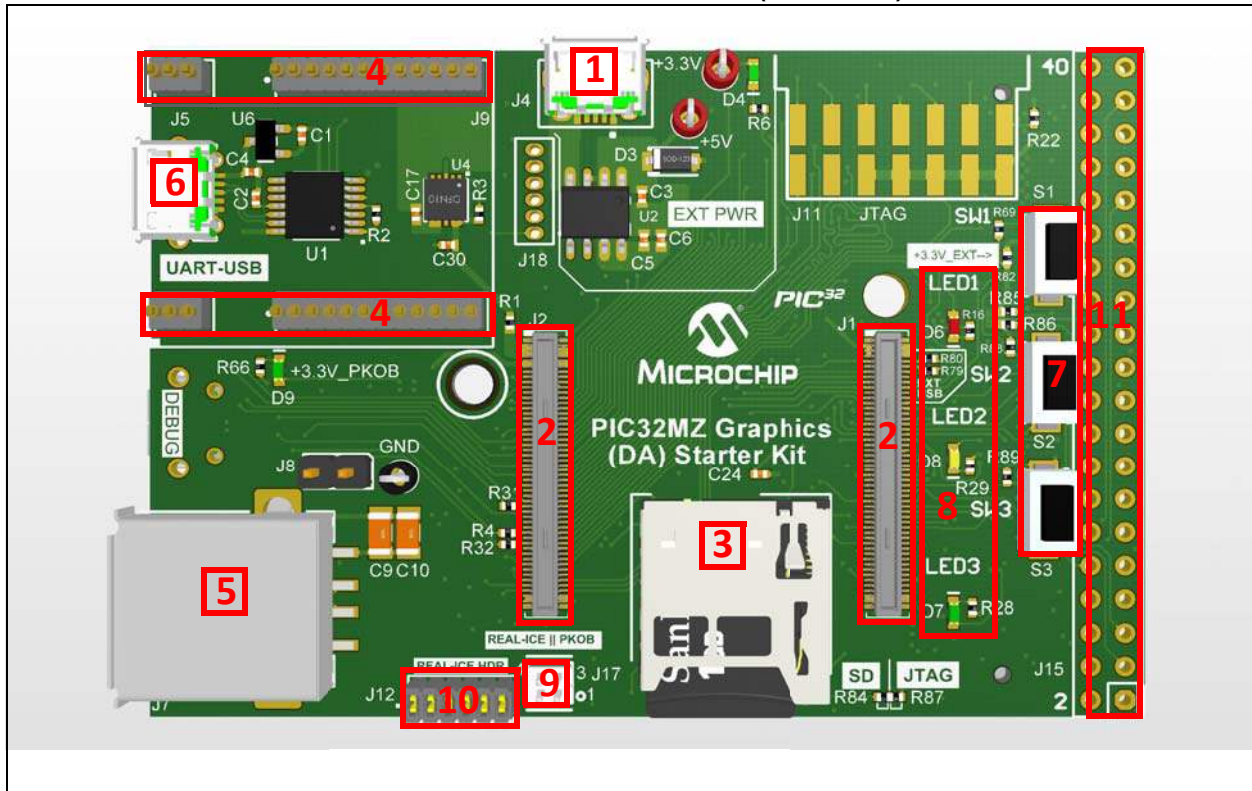

# PIC32MZ DA Family Starter Kit User's Guide

The bottom assembly of the PIC32MZ DA SK Base Board includes these key features, as indicated in [Figure 1-3](#).

1. USB Micro-B connector for on-board debugger (J19).
2. USB Type Micro-AB receptacle for OTG and USB device connectivity for PIC32 OTG/Device-based applications (J6).
3. PIC24FJ256GB106 USB microcontroller for on-board debugging (U7).
4. SST26VF032B SQI-Flash Memory (U5).
5. 50 MHz Ethernet PHY oscillator (Y1).
6. 168-pin Hirose connector for various application boards, such as MEB-II (J3).

**FIGURE 1-3: PIC32MZ DA SK BASE BOARD LAYOUT (BOTTOM VIEW)**

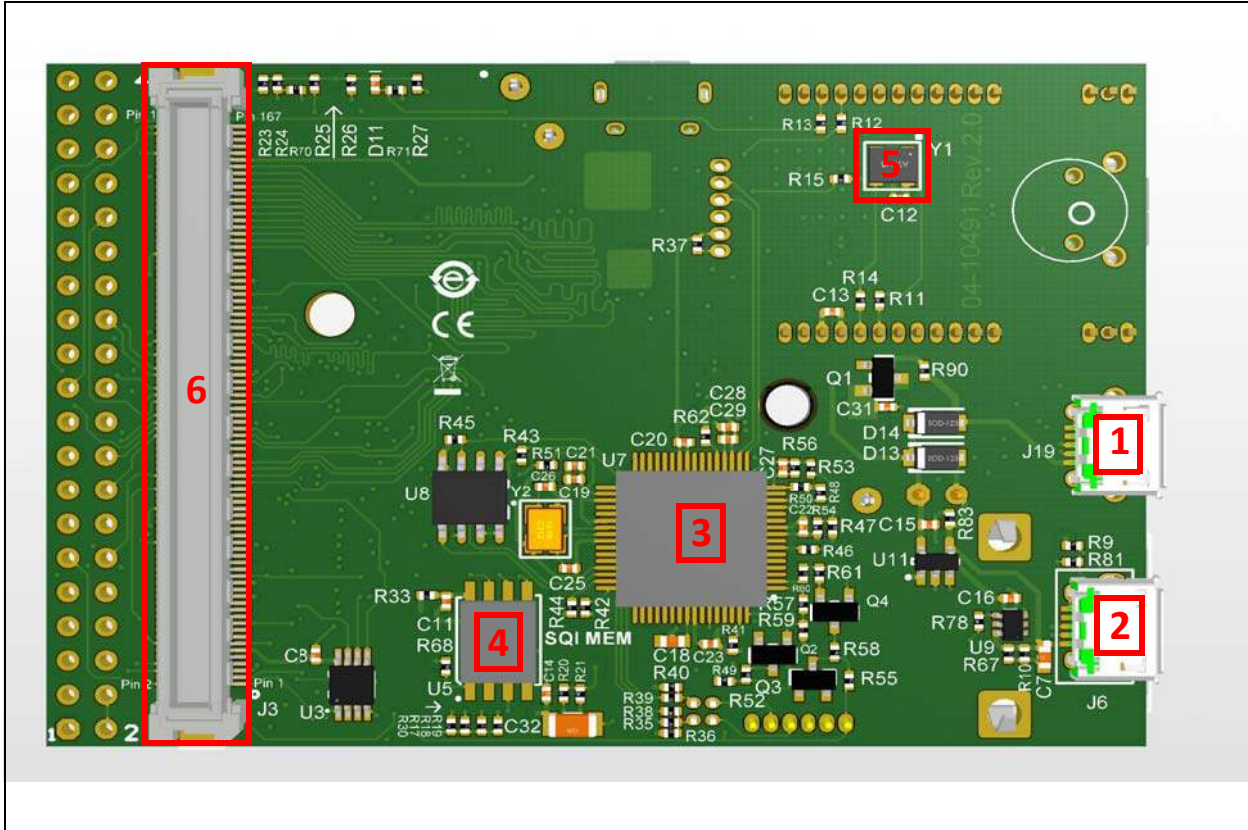



The top assembly of the PIC32MZ2064DAx288 Daughter Card includes these key features, as indicated in [Figure 1-4](#).

1. PIC32MZ2064DAA288 (DM320008) or PIC32MZ2064DAB288 (DM320008-C) (U1).
2. Micron 1 Gbit DDR2-SDRAM (MT47H64M16NF-25E) (U3).
3. 24 MHz oscillator (Y1).
4. 24 MHz crystal (Y3) and 32.768 kHz clock (Y2).

**Note:** Y2 and Y3 are 'Do Not Populate' (DNP).

5. 1.8V Regulator (power supply for DDR2-SDRAM, V<sub>DDR1V8</sub> and V<sub>DDCORE</sub>) (MIC69101) (J7).
6. 3.3V Power LED (LD2).

**FIGURE 1-4: PIC32MZ2064DAx288 DAUGHTER CARD LAYOUT (TOP VIEW)**

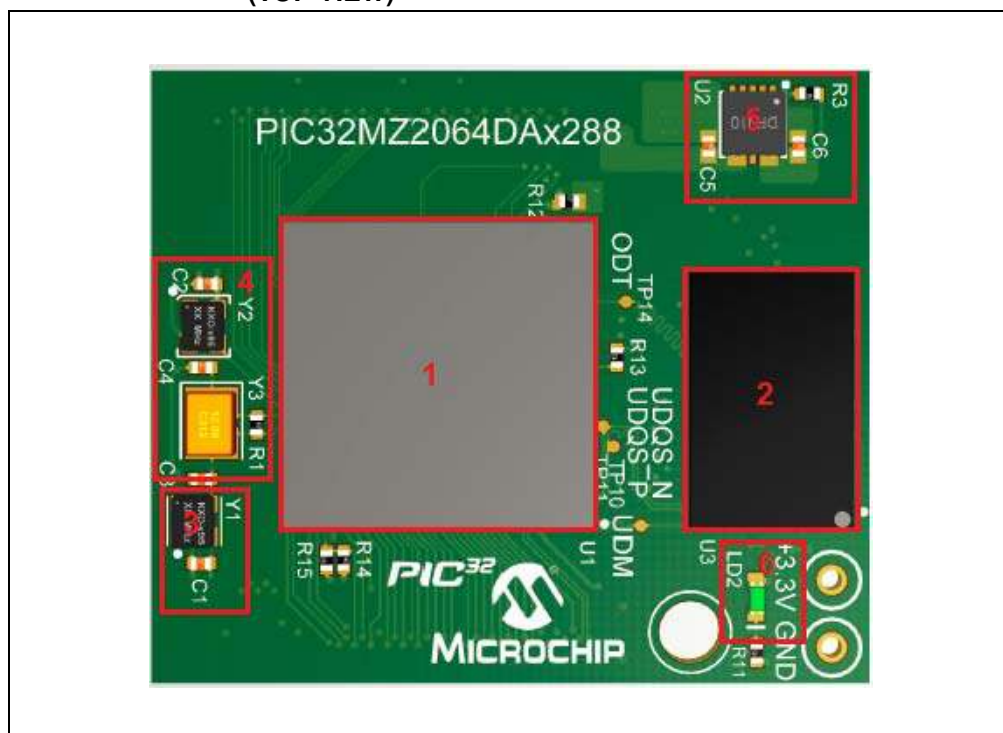

# PIC32MZ DA Family Starter Kit User's Guide

The bottom assembly of the PIC32MZ2064DAx288 Daughter Card includes these key features, as indicated in [Figure 1-5](#).

1. Headers to connect the PIC32MZ DA SK Base Board Daughter Cards.

**FIGURE 1-5: PIC32MZ2064DAx288 DAUGHTER CARD LAYOUT (BOTTOM VIEW)**

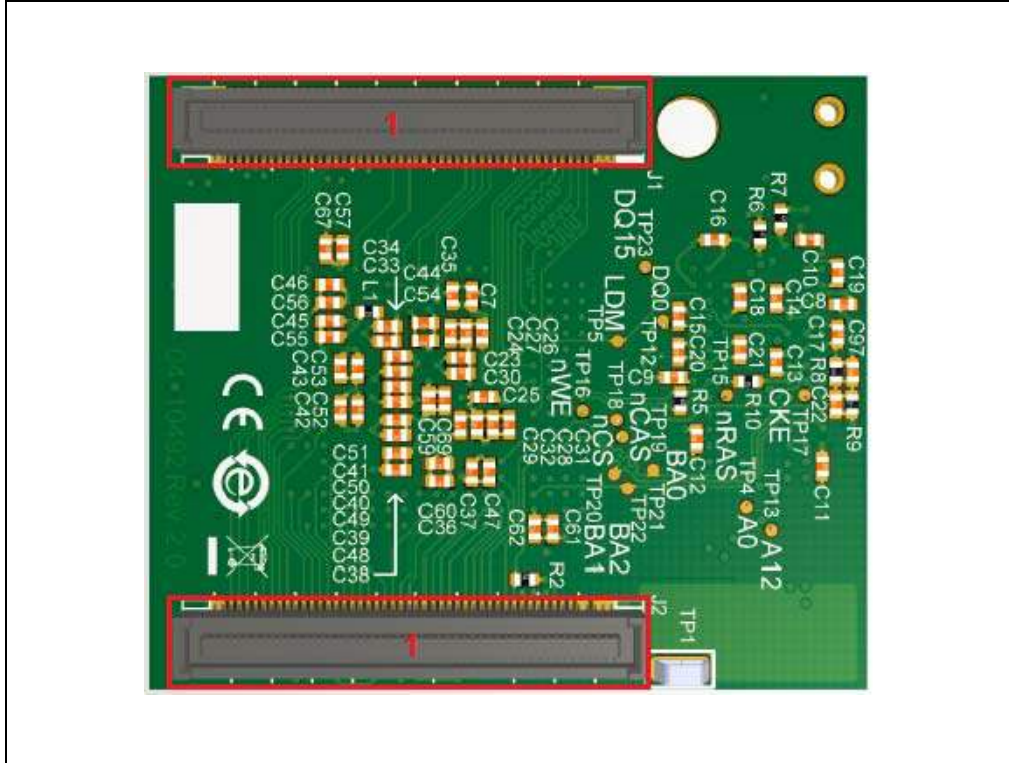

The top assembly of the PIC32MZ2064DAx169 Daughter Card includes these key features, as indicated in Figure 1-6:

1. PIC32MZ2064DAA169 (DM320010) or PIC32MZ2064DAB169 (DM320010-C) (U1).
2. 24 MHz oscillator (Y2).
3. 24 MHz crystal (Y3).

**Note:** Y3 is 'Do Not Populate' (DNP).

4. 32.768 kHz crystal (Y1)

**Note:** Y1 is 'Do Not Populate' (DNP).

5. 1.8V Regulator (power supply for DDR2-SDRAM, V<sub>DDR1V8</sub> and V<sub>DDCORE</sub>) (MIC69101) (J7).
6. 3.3V Power LED (LD2).

**FIGURE 1-6: PIC32MZ2064DAx169 DAUGHTER CARD LAYOUT (TOP VIEW)**

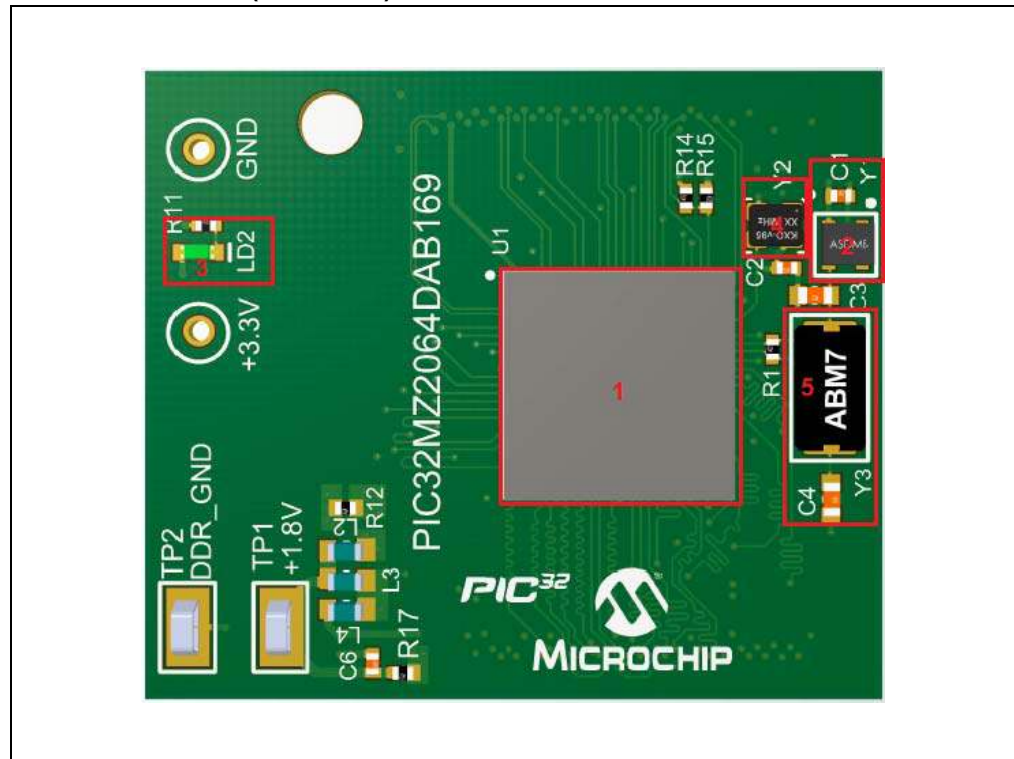

# PIC32MZ DA Family Starter Kit User's Guide

The bottom assembly of the PIC32MZ2064DAx169 Daughter Card includes these key features, as indicated in [Figure 1-7](#).

1. Headers to connect the PIC32MZ DA SK Base Board Daughter Cards.

**FIGURE 1-7: PIC32MZ2064DAx169 DAUGHTER CARD LAYOUT (BOTTOM VIEW)**

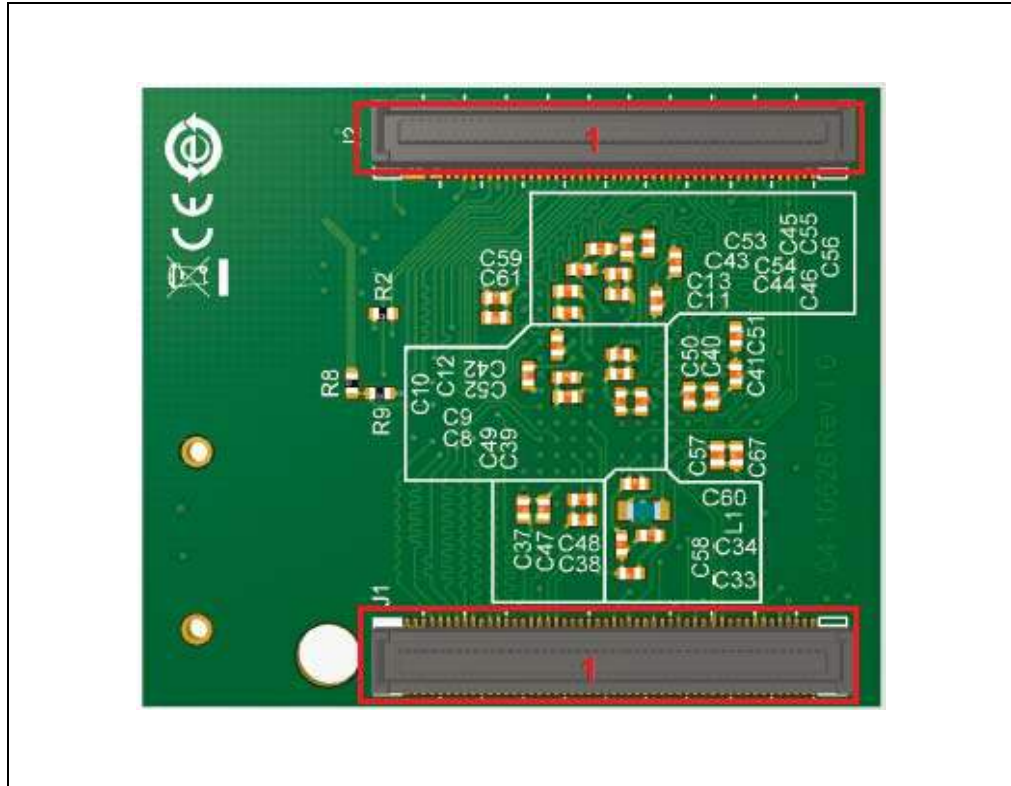

## 1.3.2 LAN8740A PHY Daughter Board

Representation of the layout of the daughter board included in the PIC32MZ DA Family Starter Kit is shown in [Figure 1-8](#) and [Figure 1-9](#).

**FIGURE 1-8: DAUGHTER BOARD LAYOUT (TOP VIEW)**

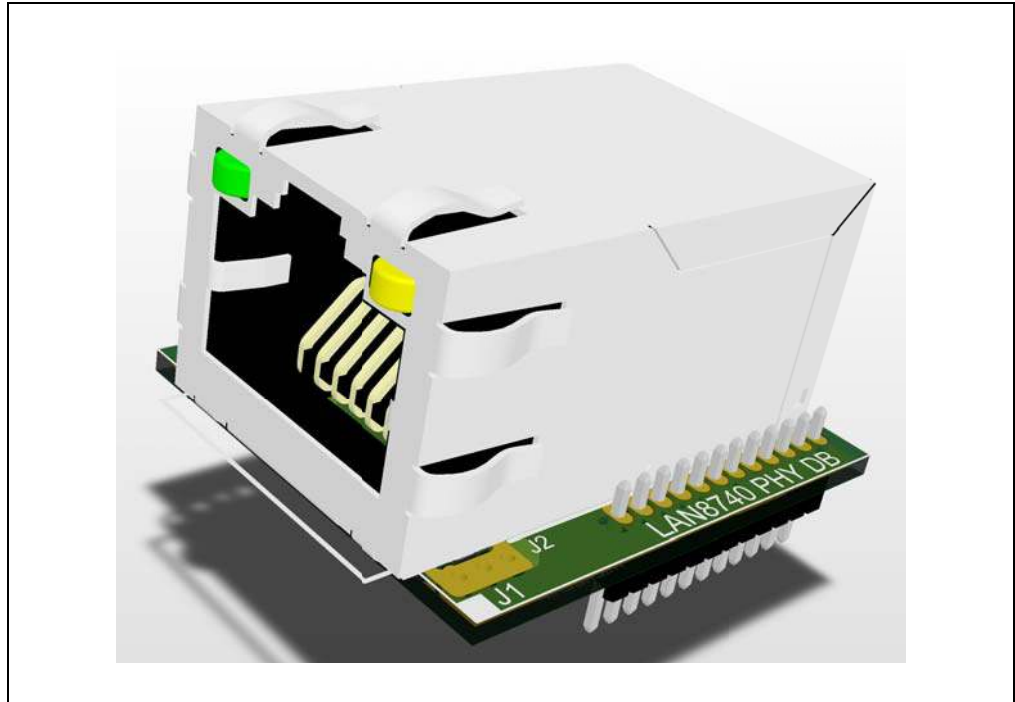

**FIGURE 1-9: DAUGHTER BOARD LAYOUT (BOTTOM VIEW)**

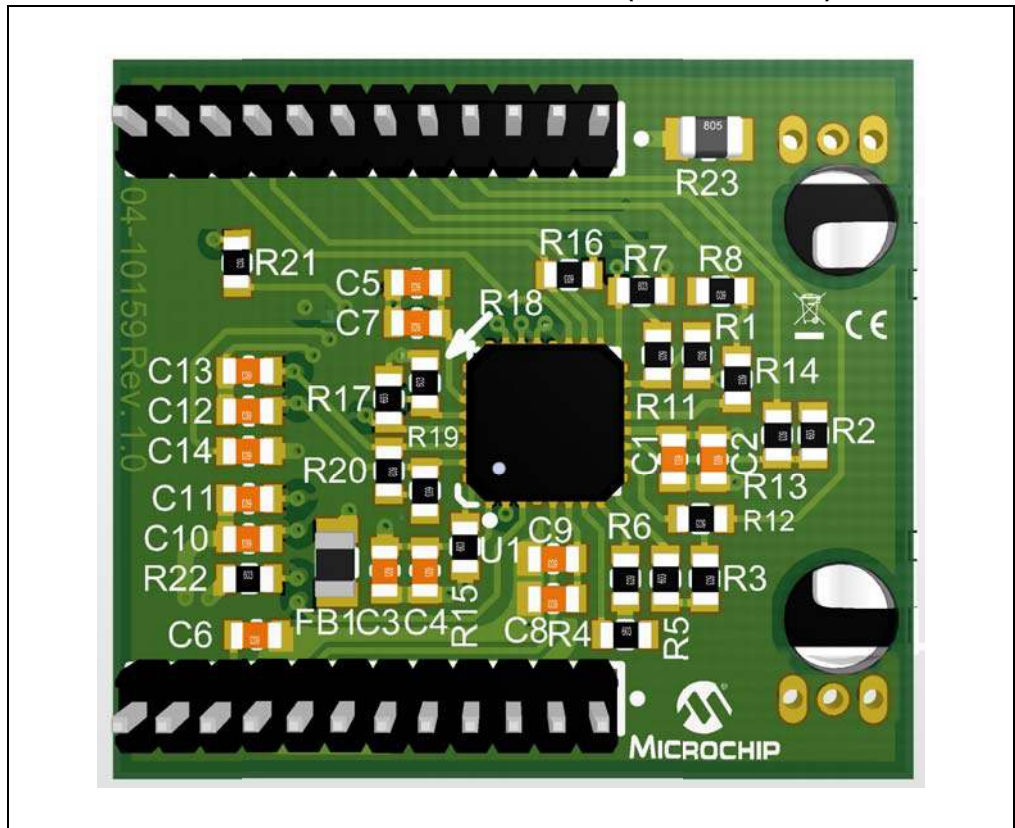

# PIC32MZ DA Family Starter Kit User's Guide

---

NOTES:

---

---

## Chapter 2. Hardware

---

---

This chapter describes the hardware features of the PIC32MZ DA Starter Kit.

### 2.1 HARDWARE FEATURES

The following key features of the starter kit are presented in the order given in [Section 1.3 “Starter Kit Functionality and Features”](#). You can refer to [Figure 1-2](#) through [Figure 1-7](#) for their locations on the development board.

#### 2.1.1 Processor Support

Depending on the starter kit that you have purchased, the development board comes with a CPU Daughter Card containing a permanently mounted (i.e., soldered) processor as given below:

- PIC32MZ Embedded Graphics External DRAM (DA) Starter Kit (DM320008): PIC32MZ2064DAA288
- PIC32MZ Embedded Graphics External DRAM (DA) Starter Kit (Crypto) (DM320008-C): PIC32MZ2064DAB288
- PIC32MZ Embedded Graphics Stacked DRAM (DA) Starter Kit (DM320010): PIC32MZ2064DAG169
- PIC32MZ Embedded Graphics Stacked DRAM (DA) Starter Kit (Crypto) (DM320010-C): PIC32MZ2064DAA169

#### 2.1.2 Power Supply

There are four ways to supply power to the starter kit:

- Through USB Micro-B connector (J4) – This enables using a wall adapter to supply more power than traditional USB as needed by the most applications (preferred).
- Through USB Micro-B DEBUG connector (J19). This connector supports debugging/programming by MPLAB tools through PKOB<sup>®</sup> interface.
- Through USB Micro-USB connector (J6).
- An external application board with a regulated DC power supply that provides +5V can be connected to the application board connector that is provided on the bottom side of the board (J3).

One green LED (LD2) on the PIC32MZ2064DAx288 or PIC32MZ2064DAx169 CPU Daughter Card is provided to indicate the power supply to the PIC32 device.

#### 2.1.3 Graphics Connectivity

Multimedia Expansion Board II (MEB-II) is required to exercise embedded graphics features on the PIC32MZ DA devices. MEB-II comes with a 4.3” WQVGA (480” x 272”) PCAP display to showcase graphics. In addition, there is one 5.0” WVGA PACP Display Board that can be used to exercise higher resolution (800” x 480”) graphics. Both of these boards provide 24-bit color.

PIC32MZ Embedded Graphics Starter Kit has been designed with a 168-pin modular expansion interface, which allows the extendibility to MEB-II.

## 2.1.4 Debug USB Connectivity

The starter kit includes a PIC24FJ256GB106 USB microcontroller that provides debugger connectivity over USB. The PIC24FJ256GB106 MCU is hard-wired to the PIC32 device to provide protocol translation through the I/O pins of the PIC24FJ256GB106 MCU to the In-Circuit Serial Programming™ (ICSP™) pins of the PIC32 device.

If an external debugger, such as MPLAB REAL ICE or MPLAB ICD3 are used with the starter kit, it is necessary to disconnect the on-board debugger from the PIC32 device, by removing the JP17 jumper. When the on-board debugger is required, replace the JP17 jumper. When the JP17 jumper is installed, pin 1 must be connected to pin 3, and pin 2 must be connected to pin 4.

## 2.1.5 PIC32 USB Connectivity

Users can connect to the PIC32 USB microcontroller using anyone of the following modes:

- Host Mode – Connect the device to the Type-A connector J7, which is located on the top of the starter kit. Using this method, a maximum of 400 mA can be supplied from the debug USB port to the host port. If full 500 mA supply is needed, an external supply must be connected to the application board.
- Device Mode – Connect the debug Mini-B USB cable to port J6, and then connect the starter kit to the host by using a cable with a Type-B micro-connector to the starter kit's Micro-A/B port J6, which can be located on the bottom of the board. The other end of the cable must have a Type-A connector, to connect it to a USB host.
- OTG Mode – Connect the starter kit to the OTG device by using an OTG Micro-A/B cable to the Micro-A/B port J6, which is located on the bottom of the board.

## 2.1.6 External Memory Connectivity

The following three external memory interfaces are available through hardware:

- DDR2-SDRAM – 128 MB of DDR2-SDRAM is mounted on the PIC32MZ2064DAx288 Daughter Card for the External DRAM version of the starter kits (DM320008, DM320008-C). Whereas 32 MB of DDR2-SDRAM is available within the package for the stacked DRAM version of the starter kits (DM320010, DM320010-C).
- Micro-SD slot – Supports SD, SDHC, and SDXC cards at default speed (12.5 MB/s) and high speed (25 MB/s).
- SQI Flash – 4 MB of SST26VF032B Serial Quad Flash is mounted on the bottom of the PIC32MZ DA SK Base Board.

## 2.1.7 Switches

Push-button switches provide the following functionalities:

- SW1: Active-low switch connected to RB13
- SW2: Active-low switch connected to RB12
- SW3: Active-low switch connected to RB14

The push-button switches do not have any debounce circuitry and require the use of internal pull-up resistors. This enables the user to investigate software debounce techniques. When Idle, the switches are pulled high (+3.3V), and when pressed, they are grounded.



## 2.1.8 LEDs

The LEDs, RH0 through RH2, are connected to PORTH of the processor. The LATH pins are set high to light the LEDs.

## 2.1.9 Oscillator Options

A 24 MHz oscillator circuit is connected to the on-board microcontroller and this oscillator circuit functions as the controller's primary oscillator. Depending on which is populated on the starter kit board, a 24 MHz crystal may be used instead of the 24 MHz oscillator circuit.

Use of an external crystal is required to develop USB applications. The USB-specification dictates a frequency tolerance of  $\pm 0.25\%$  for high speed, and non-USB applications can use the internal oscillators.

The starter kit also has provisions for an external secondary 32 kHz oscillator; however, it is not populated. A suitable oscillator, ECS-3X8, can be obtained from Digi-Key: P/N-X801-ND CMR200TB32.768KDZFTR.

The PIC24FJ256GB106 is independently clocked and has its own 12 MHz crystal.

## 2.1.10 168-pin Modular Expansion Connector

The PIC32MZ DA Family Starter Kit has been designed with a 168-pin modular expansion interface, which allows the board to provide basic generic functionality and easy extendability to new technologies as they become available. Refer to [Table 2-1](#) for starter kit connector part numbers.

**TABLE 2-1: STARTER KIT CONNECTOR PART NUMBERS**

Connector	HIROSE Electric PN
Starter Kit Connector	FX10A-168P-SV1(71)
Application Board Connector	FX10A-168S-SV

## 2.1.11 Ethernet PHY

The Microchip LAN8740A PHY Daughter Board is populated with a low-power, small-footprint, 10/100 Fast Ethernet LAN8740A PHY, which features Energy Efficient Ethernet (IEEE 802.3az) and Wake-on-LAN functionality. This daughter board is designed for easy development of RMII Ethernet control applications when it is connected into a compatible PIC32 starter kit.

To use a different Ethernet PHY, other than what is offered, visit the microchipDIRECT website ([www.microchipdirect.com](http://www.microchipdirect.com)) for a list of alternate options.

## 2.1.12 USB-to-UART/I<sup>2</sup>C Communication

To facilitate application debug and development, a MCP2221 USB-to-UART/I<sup>2</sup>C device (U1) is available. The MCP2221 creates a virtual COM port on the personal computer when a mini-USB cable is connected between J11 and the host computer. To download the driver for the MCP2221, visit the MCP2221 product page ([www.microchip.com/MCP2221](http://www.microchip.com/MCP2221)).

# PIC32MZ DA Family Starter Kit User's Guide

Table 2-2 lists the MCP2221 UART and I<sup>2</sup>C pins that are connected to the PIC32MZ DA device.

**TABLE 2-2: MCP2221 UART PIN CONNECTIONS**

MCP2221 (Note 1)		PIC32MZ DA Device		PIC32MZ Device UART/I <sup>2</sup> C Function
Pin #	Function	Pin #	Full Pin Name	
4	RX	61	EBIA2/AN23/C2INC/RPG9/PMA2/RG9	U2TX
5	TX	14	PGED1/AN0/RPB0/CTED2/RB0	U2RX
9	SCL	16	RPF8/SCL3/RF8	SCL3
10	SDA	15	RPF2/SDA3/RF2	SDA3

**Note 1:** The CTS and RTS functions are not required, but are available if desired. The MCP2221 configuration utility can be used to turn those functions on and off.

## 2.1.13 40-pin Expansion Connector

On the back of the starter kit is a 40-pin (2 x 20) header (J15) which can be used to add expansion boards to the starter kit. The header provides 2-pin UART (through UART4 or UART6), I<sup>2</sup>C (through I2C2), SPI (through SPI1) and GPIO capabilities. Table 2-3 provides the pins and the functions available through them.

**TABLE 2-3: J15 CONNECTIONS**

Function 1	Function 2	Pin #	Pin #	Function 2	Function 1
—	+3V3	1	2	+5V	—
RF2	SDA2	3	4	+5V	—
RF8	SCL2	5	6	GND	—
RE4	GPIO	7	8	UxTX	RC3
—	GND	9	10	UxRX	RE8
RE7	GPIO	11	12	GPIO	RH3
RB8	GPIO	13	14	GND	—
RA9	GPIO	15	16	GPIO	RB4
—	+3V3	17	18	GPIO	RH4
RG8	MOSI	19	20	GND	—
RD7	MISO	21	22	GPIO	RH6
RG6/SCK2	SCLK	23	24	CE0	RD0
—	GND	25	26	CE1	RD14
RB2	GPIO	27	28	No Connect	—
RK1	GPIO	29	30	GND	—
RK2	GPIO	31	32	GPIO	RJ2
RG9	GPIO	33	34	GND	—
RB0	GPIO	35	36	GPIO	RB15
RH7	GPIO	37	38	GPIO	RH12
—	GND	39	40	GPIO	RD15

## Appendix A. Schematics

---

---

### A.1 SCHEMATICS

The PIC32MZ DA Family Starter Kit schematics are as follows:

- PIC32MZ2064DAx288 Daughter Card ([Figure A-1](#) through [Figure A-4](#))
- PIC32MZ2064DAx169 Daughter Card ([Figure A-5](#) through [Figure A-7](#))
- PIC32MZ DA SK Base Board ([Figure A-8](#) through [Figure A-12](#))
- LAN8740 PHY Daughter Card ([Figure A-13](#))

# PIC32MZ DA Family Starter Kit User's Guide

FIGURE A-1: PIC32MZ2064DAX288 DAUGHTER CARD SCHEMATICS (1 OF 4)

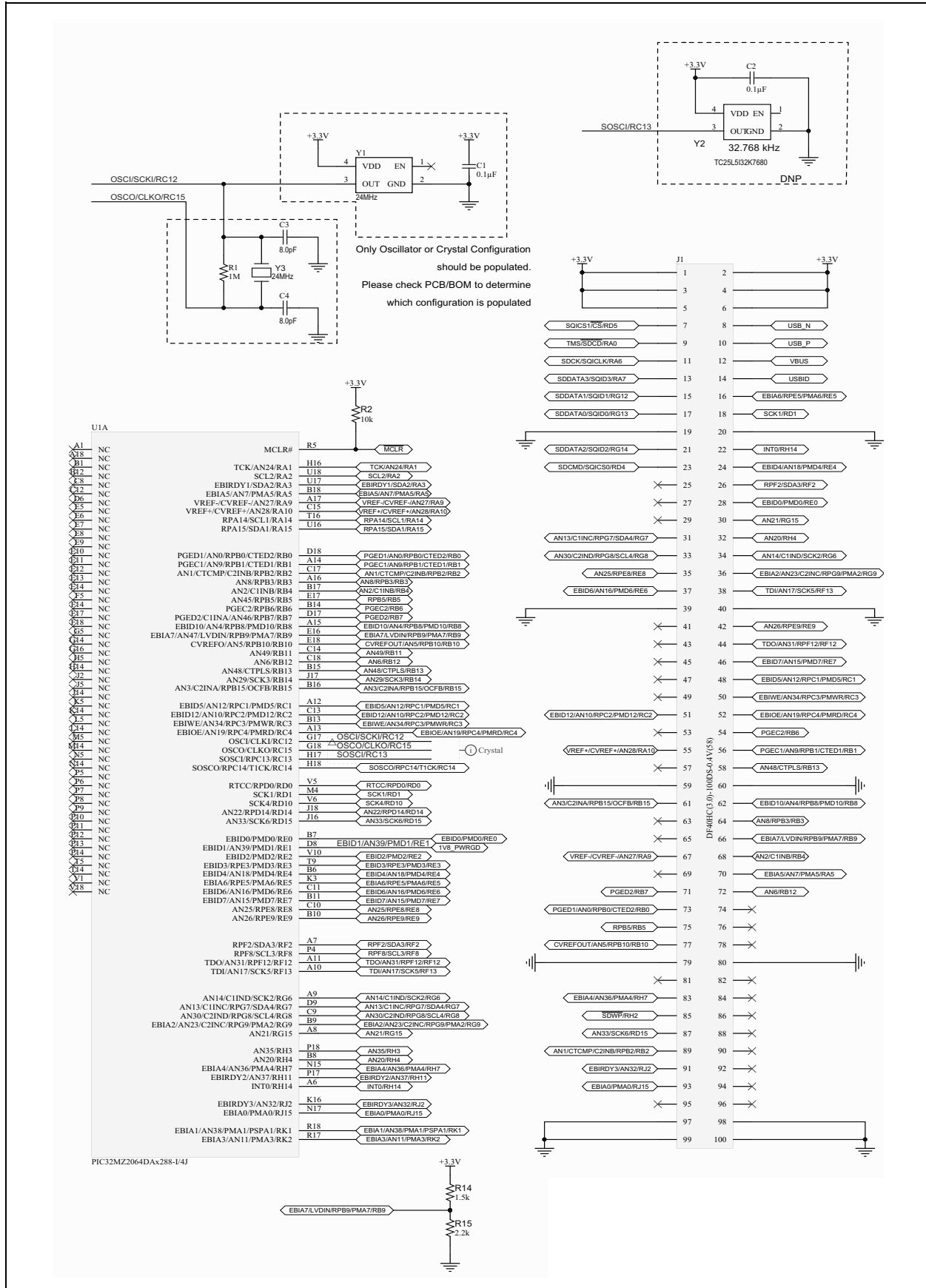

FIGURE A-2: PIC32MZ2064DAX288 DAUGHTER CARD SCHEMATICS (2 OF 4)

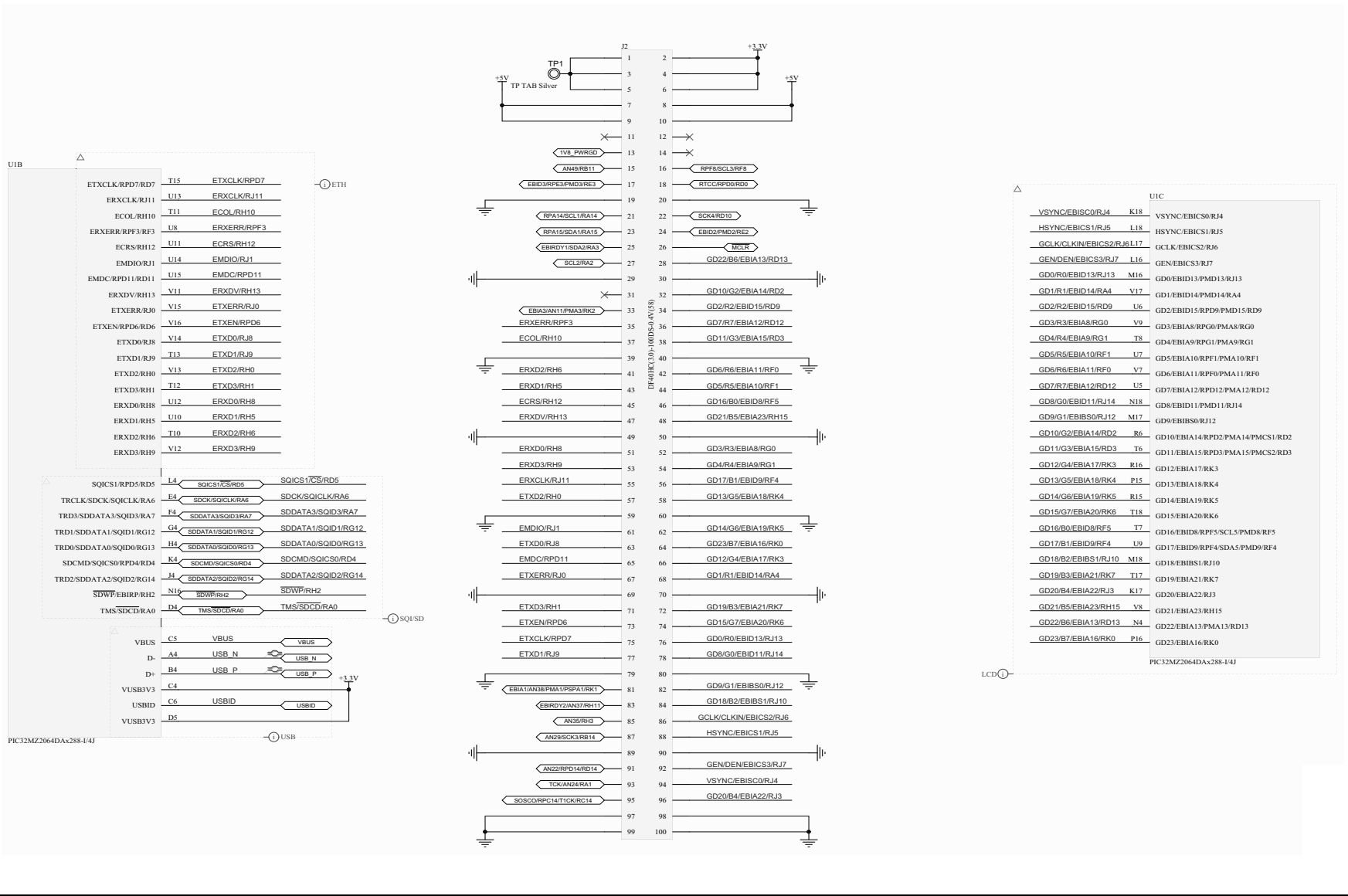
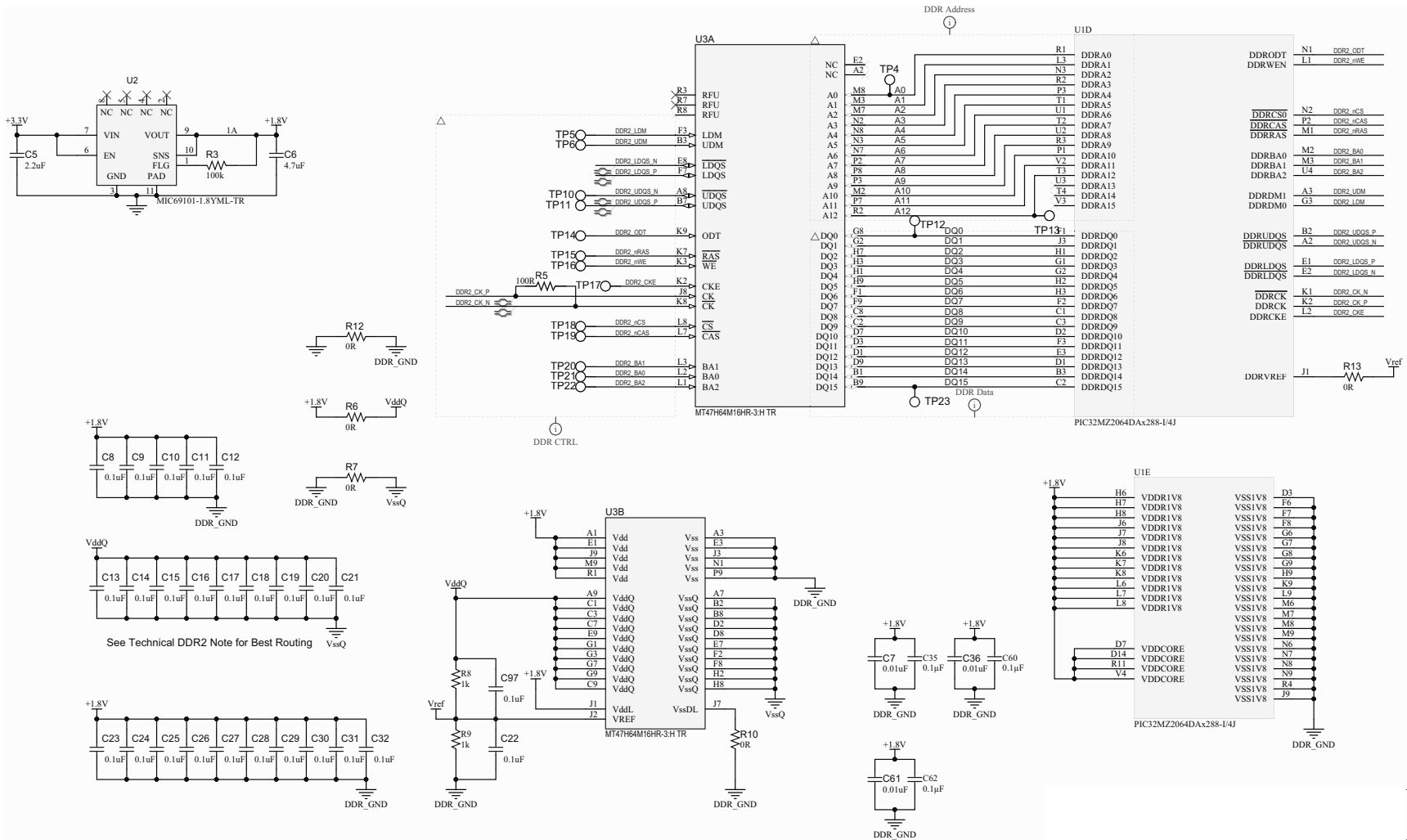
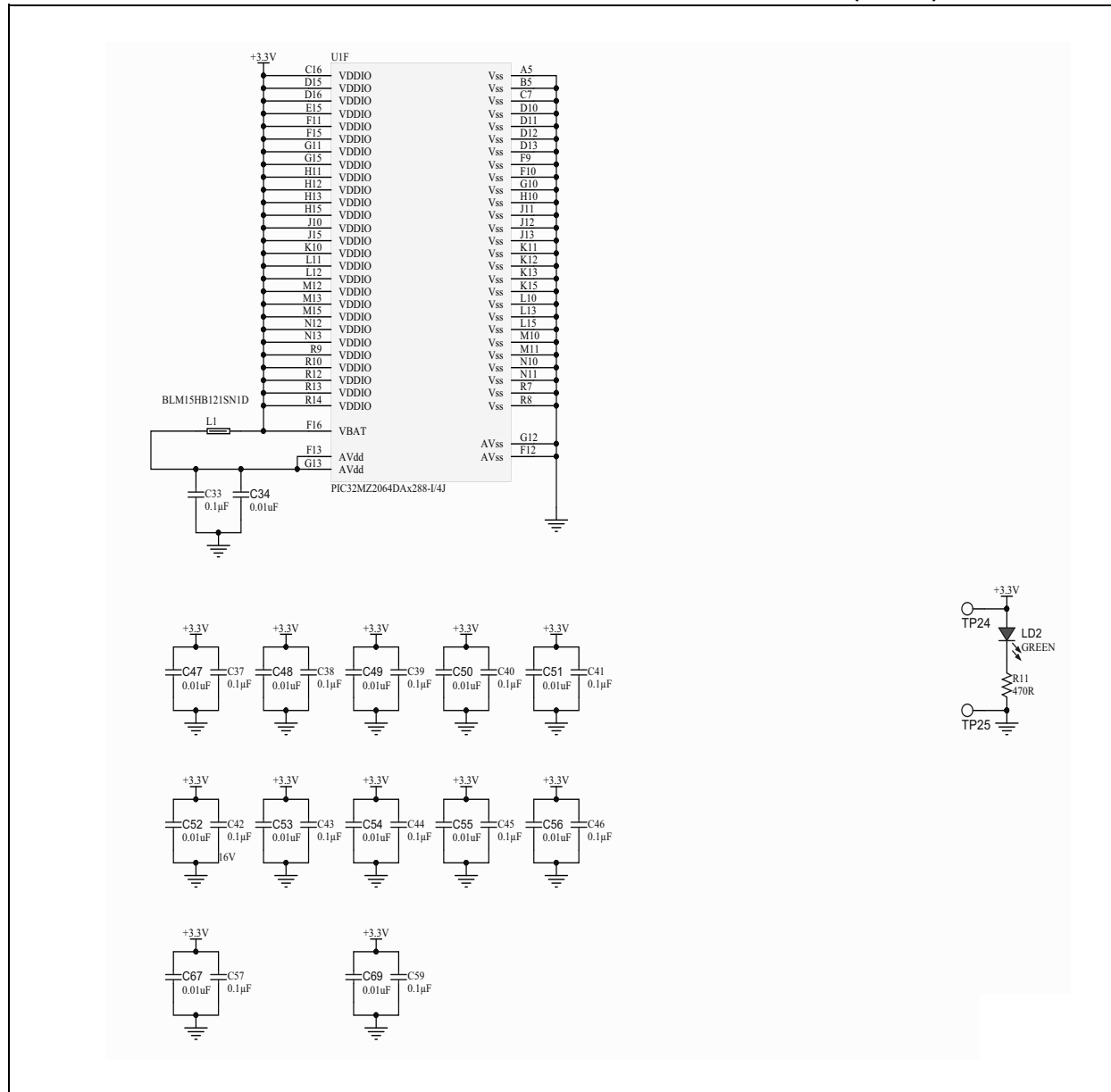

FIGURE A-3: PIC32MZ2064DAX288 DAUGHTER CARD SCHEMATICS (3 OF 4)



**FIGURE A-4: PIC32MZ2064DAX288 DAUGHTER CARD SCHEMATICS (4 OF 4)**



# PIC32MZ DA Family Starter Kit User's Guide

FIGURE A-5: PIC32MZ2064DAX169 DAUGHTER CARD SCHEMATICS (1 OF 3)

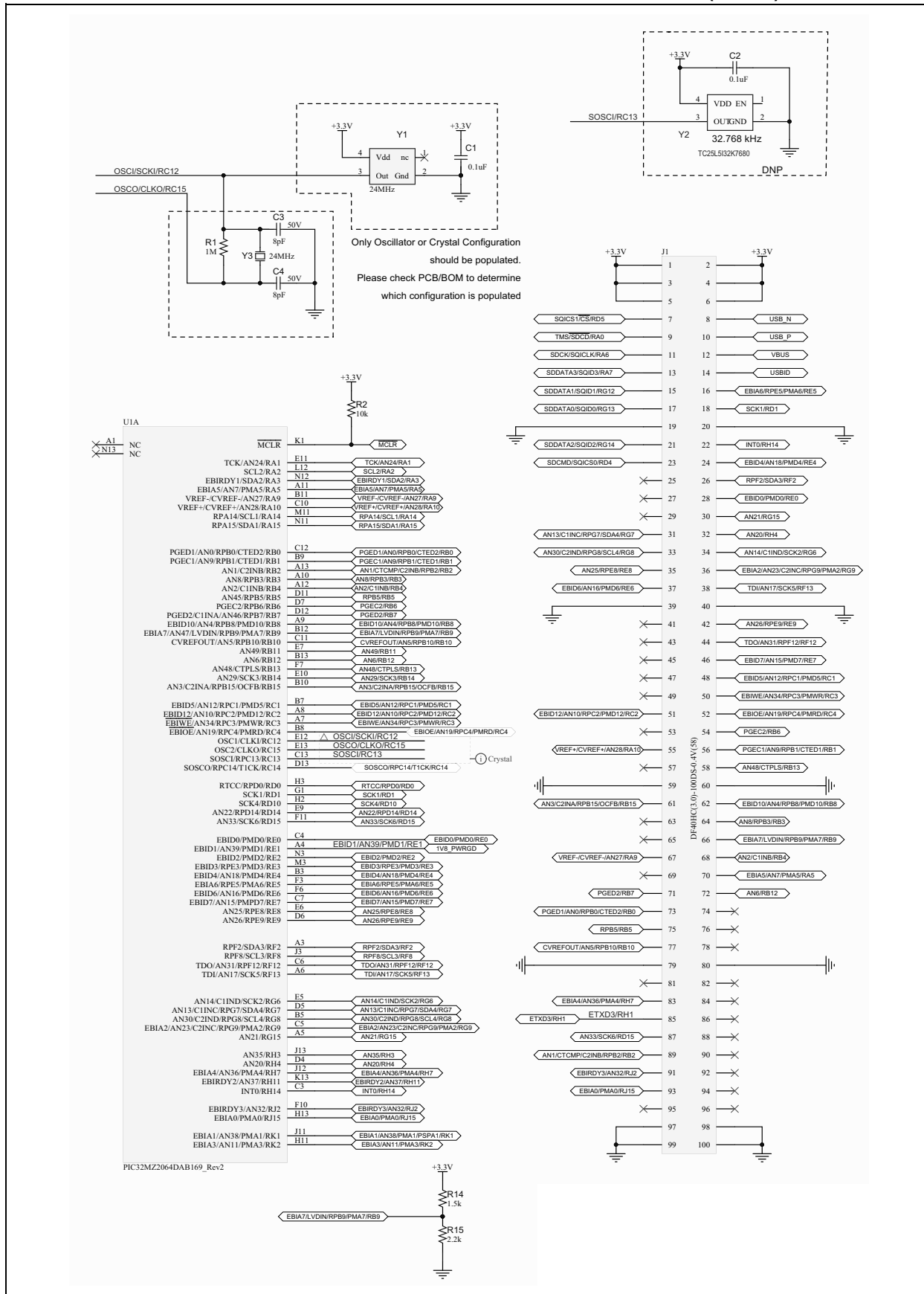
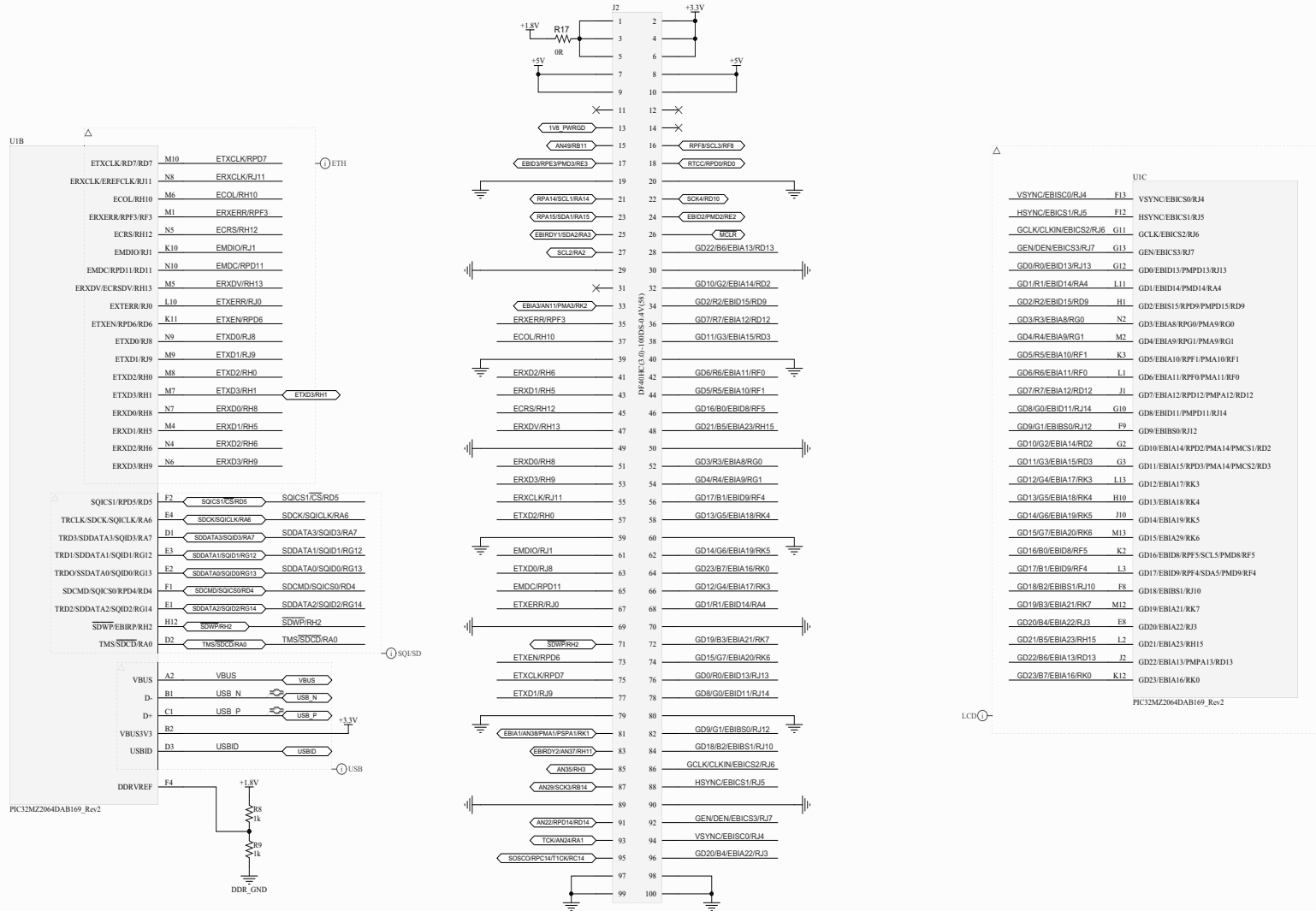



FIGURE A-6: PIC32MZ2064DAX169 DAUGHTER CARD SCHEMATICS (2 OF 3)



# PIC32MZ DA Family Starter Kit User's Guide

FIGURE A-7: PIC32MZ2064DAX169 DAUGHTER CARD SCHEMATICS (3 OF 3)

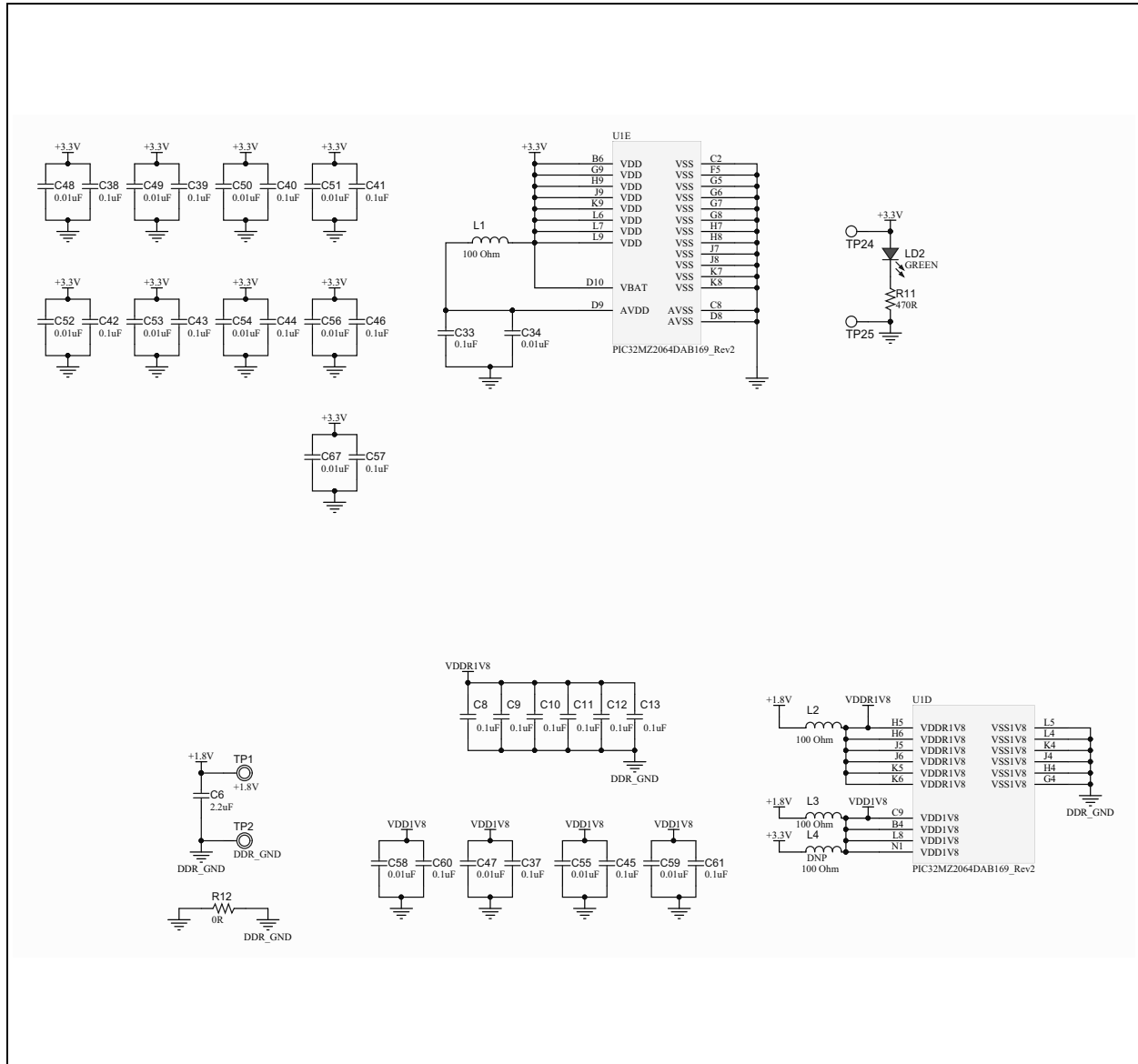

FIGURE A-8: PIC32MZ DA SK BASE BOARD SCHEMATICS (1 OF 5)

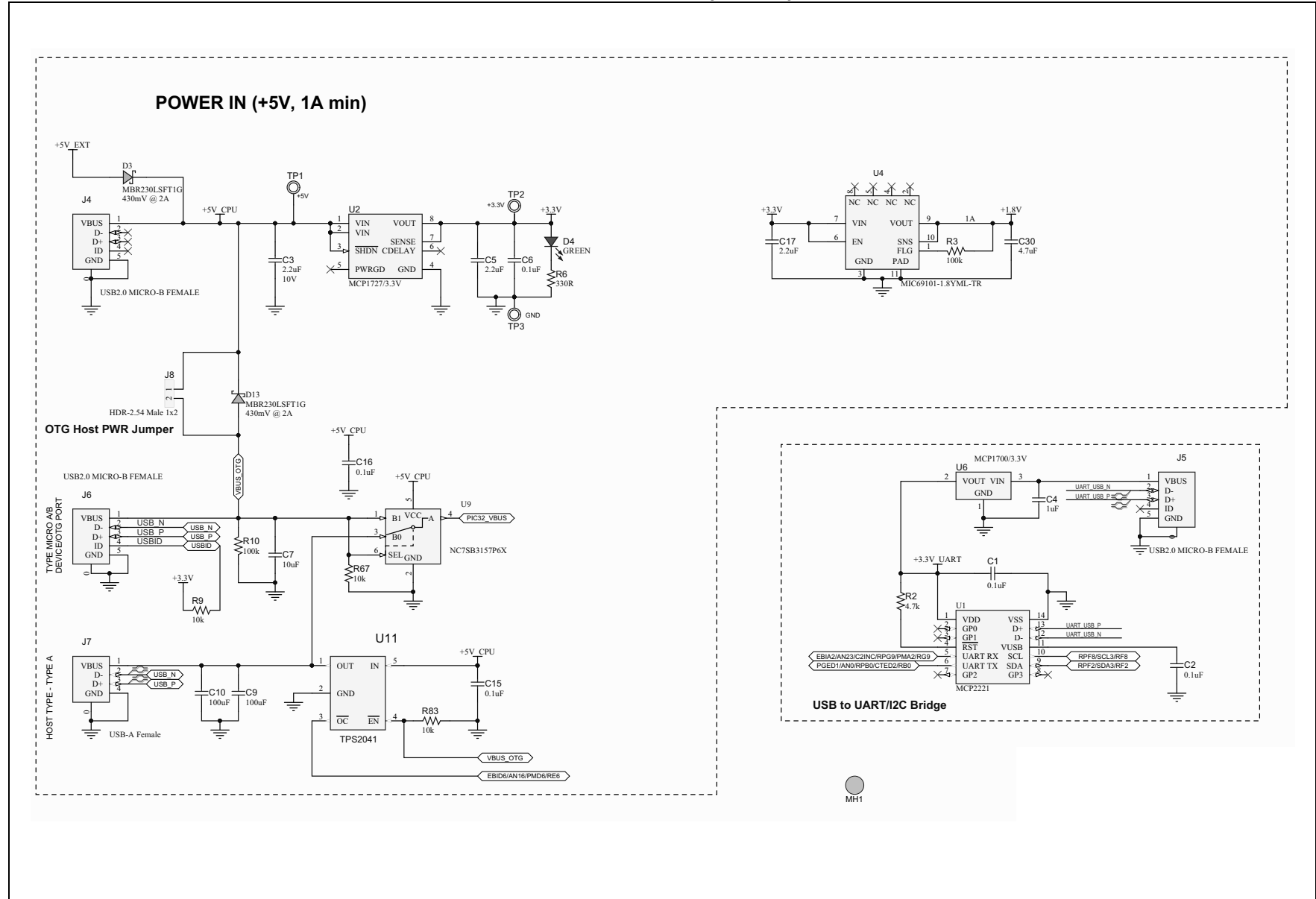
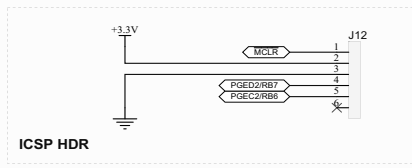
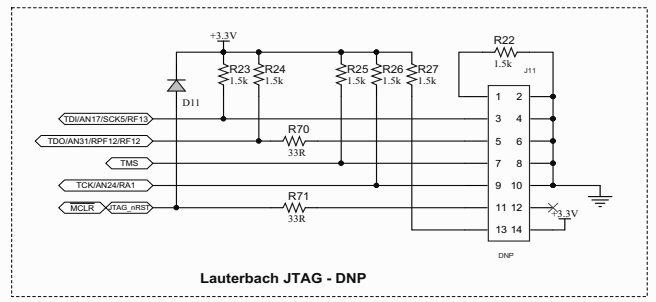
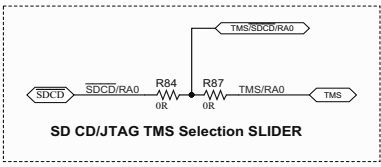
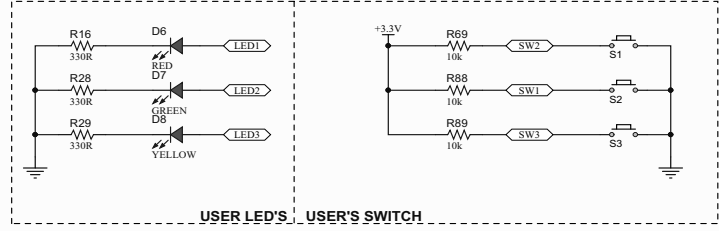
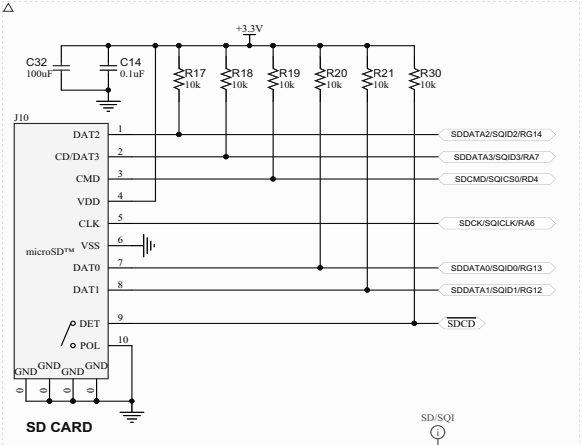
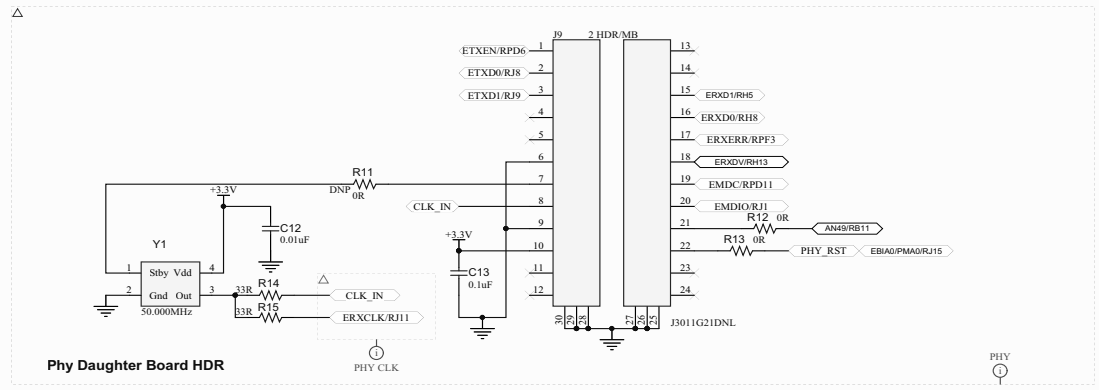
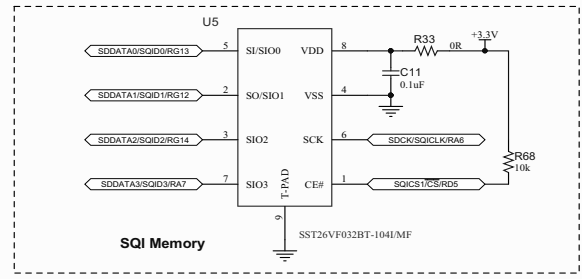

FIGURE A-9: PIC32MZ DA SK BASE BOARD SCHEMATICS (2 OF 5)



**FIGURE A-10: PIC32MZ DA SK BASE BOARD SCHEMATICS (3 OF 5)**

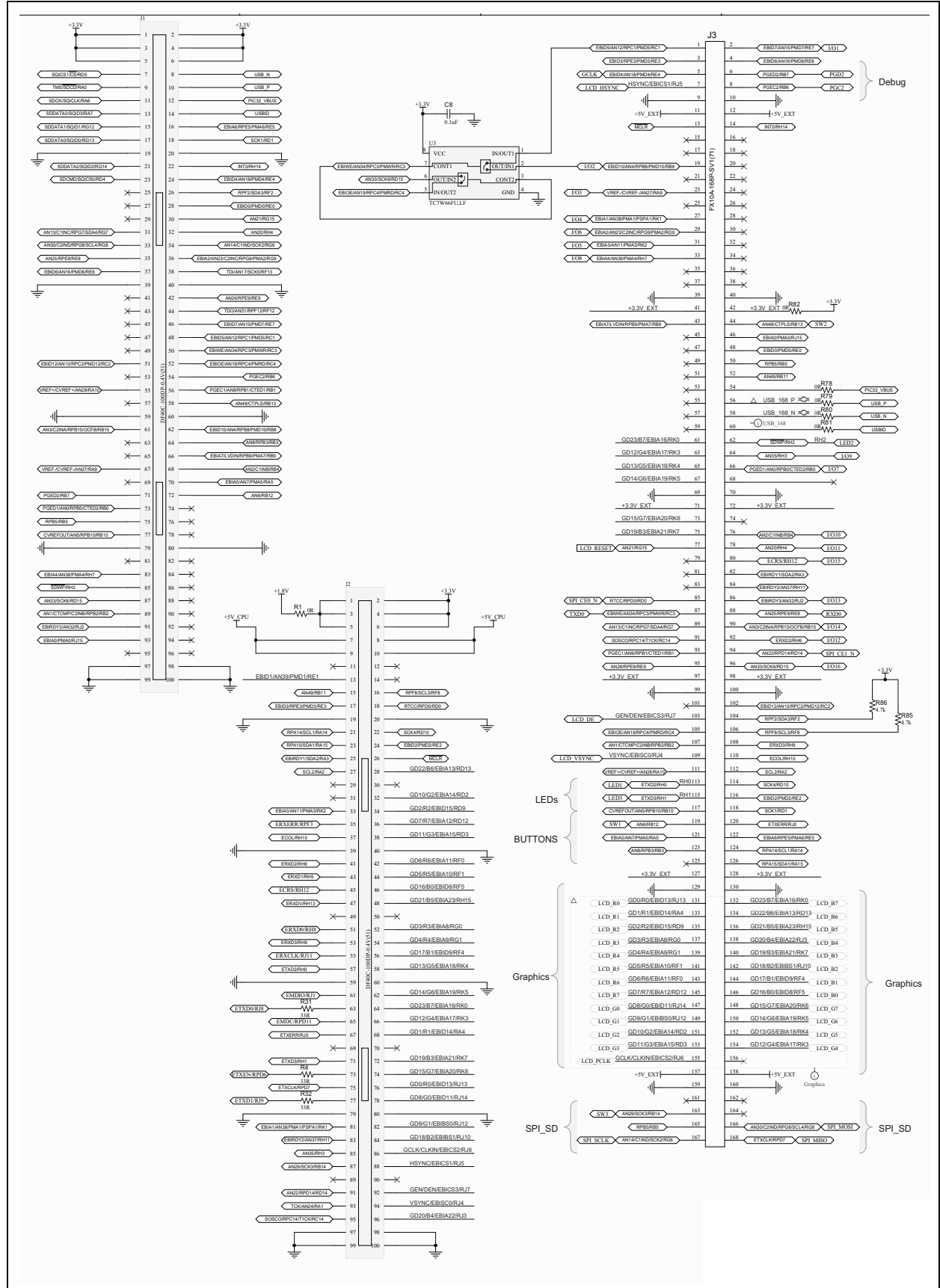

FIGURE A-11: PIC32MZ DA SK BASE BOARD SCHEMATICS (4 OF 5)

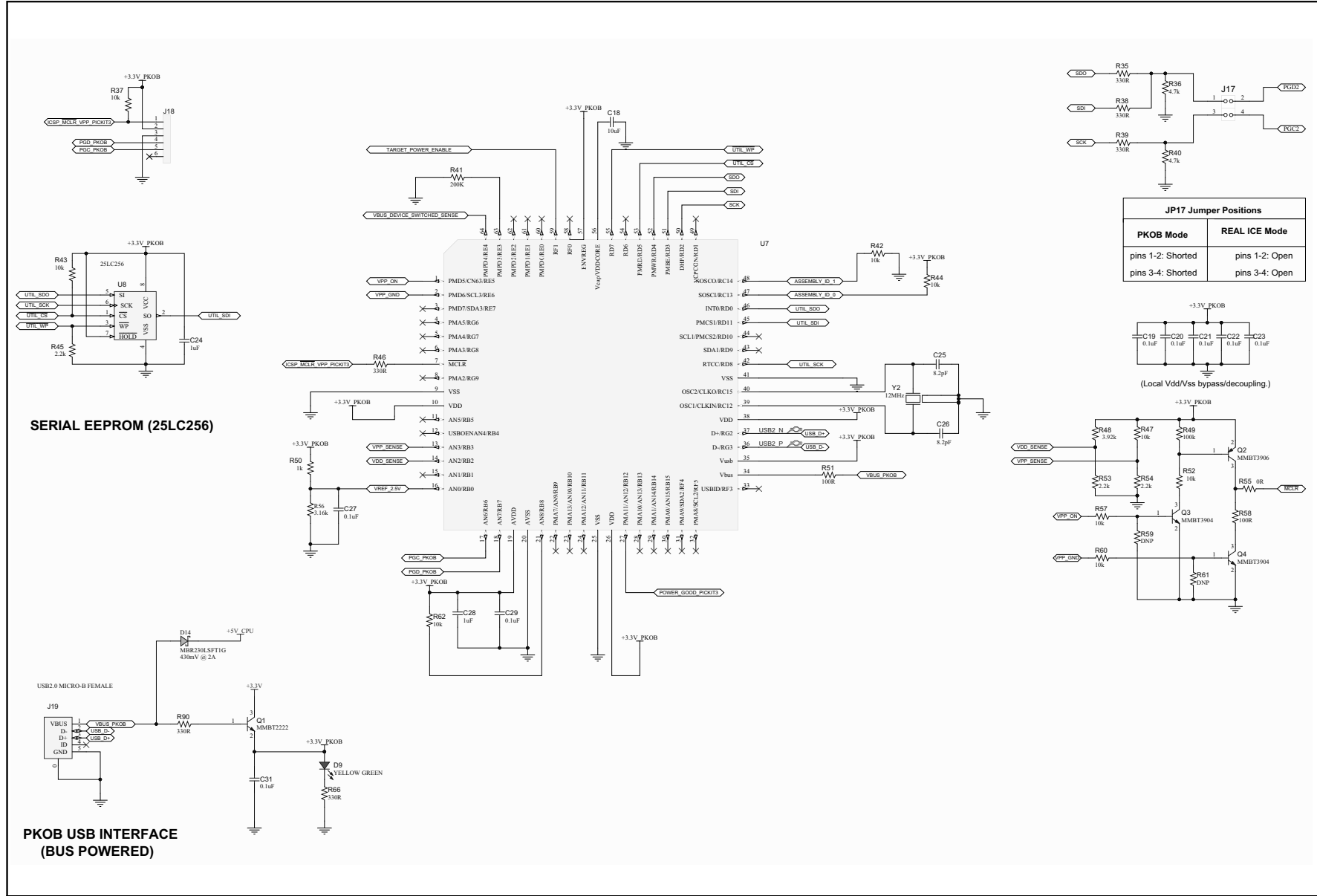
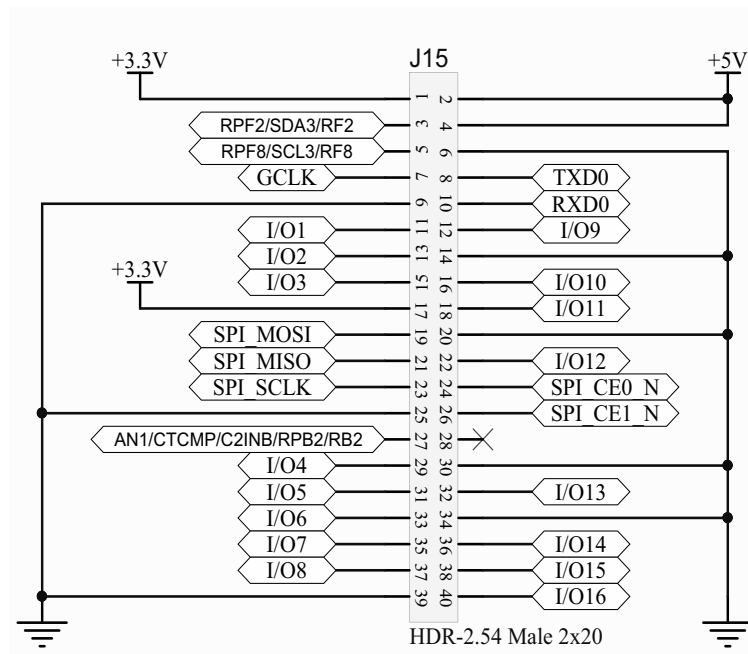

FIGURE A-12: PIC32MZ DA SK BASE BOARD SCHEMATICS (5 OF 5)









# PIC32MZ DA FAMILY STARTER KIT USER'S GUIDE

## Appendix B. Bill of Materials

### B.1 PIC32MZ2064DAX288 DAUGHTER CARD BILL OF MATERIALS

TABLE B-1: PIC32MZ2064DAX288 DAUGHTER CARD BILL OF MATERIALS

Quantity	Reference	Description	Manufacturer	Part No.
44	C1, C2, C8, C9, C10, C11, C12, C13, C14, C15, C16, C17, C18, C19, C20, C21, C22, C23, C24, C25, C26, C27, C28, C29, C30, C31, C32, C33, C35, C37, C38, C39, C40, C41, C42, C43, C44, C45, C46, C57, C59, C60, C62, C97	CAP CER 0.1uF 16V 10% X7R SMD 0402	Murata	GRM155R71C104KA88D
16	C7, C34, C36, C47, C48, C49, C50, C51, C52, C53, C54, C55, C56, C61, C67, C69	CAP CER 0.01uF 16V 10% X7R SMD 0402	KEMET	C0402C103K4RACTU
1	C6	CAP CER 4.7uF 6.3V 20% X5R SMD 0402	Murata	GRM155R60J475ME47D
1	C5	CAP CER 2.2uF 10V 10% X5R 0402	Murata	GRM155R60J475ME47D
1	L1	FILTER CHIP 120 OHM 300MA 0402	Murata	BLM15HB121SN1D
1	LD2	DIO LED GREEN 1.7V 20mA SMD 0603	OSRAM	LG L29K-G2J1-24-Z
1	R2	RES TKF 10k 5% 1/10W SMD 0402	Panasonic	ERJ-2GEJ103X
1	R3	RES TKF 100k 1% 1/10W SMD 0402	Panasonic	ERJ-2RKF1003X
1	R5	RES TKF 100R 5% 1/16W SMD 0402	Yageo	RC0402JR-07100RL
5	R6, R7, R10, R12, R13	RES TKF 0R SMD 0402	Panasonic	ERJ-2GE0R00X
2	R8, R9	RES SMD 1K OHM 1% 1/16W 0402	Stackpole Inc.	RMCF0402FT1K00
1	R11	RES 470 OHM 1/16W 1% 0402 SMD	Rohm Semiconductor	MCR01MRTF4700
1	R14	RES TKF 1.5k 5% 1/16W SMD 0402	Rohm Semiconductor	MCR01MRTJ152
1	R15	RES TKF 2.2k 1% 1/10W SMD 0402	Panasonic	ERJ-2RKF2201X
1	Y1	ASDMB-24.000MHZ-LC-T	Abracon LLC	ASDMB-24.000MHZ-LC-T
1	U2	IC REG LDO 1.8V 1A 10MLF	Microchip Technology	MIC69101-1.8YML-TR
1	TP24	TEST POINT PC MINI .040"D RED	Keystone Electronics	5000
1	TP25	TEST POINT PC MINI .040"D BLACK	Keystone Electronics	5001
1	TP1	CON TP TAB Silver Mini 3.8x2.03 SMD	Keystone Electronics	5019
2	J1, J2	CONN RCPT 100POS 0.4MM SMD GOLD	Hirose Electric Co Ltd	DF40HC(3.0)-100DS-0.4V(58)
1	U3	IC DDR2 SDRAM 1GBIT 3NS 84FBGA	Micron Technology	MT47H64M16HR-3:H TR
1	U1	288 pin PIC32 BGA Non-Crypto	Microchip Technology	PIC32MZ2064DAB288-I/4J

# PIC32MZ DA Family Starter Kit User's Guide

**TABLE B-1: PIC32MZ2064DAx288 DAUGHTER CARD BILL OF MATERIALS (CONTINUED)**

Quantity	Reference	Description	Manufacturer	Part No.
DNP	TP4, TP5, TP6, TP10, TP11, TP12, TP13, TP14, TP15, TP16, TP17, TP18, TP19, TP20, TP21, TP22, TP23			
DNP	C3, C4	CAP CER 8PF 50V NP0 0603	TDK Corporation	C1608C0G1H080D080AA
DNP	R1	RES SMD 1M OHM 1% 1/10W 0402	Panasonic	ERJ-2RKF1004X
DNP	Y3	CRYSTAL 24.000MHZ 8PF SMD	AVX Corp/Kyocera Corp	CX3225GA24000D0PTVZ1
DNP	Y2	OSCILLATOR 32.768KHZ 3.3V SMD	CTS-Frequency Controls	TC25L5I32K7680

## B.2 PIC32MZ2064DAx169 DAUGHTER CARD BILL OF MATERIALS

TABLE B-2: PIC32MZ2064DAx169 DAUGHTER CARD BILL OF MATERIALS

Quantity	Reference	Description	Manufacturer	Part No.
22	C1, C2, C8, C9, C10, C11, C12, C13, C33, C37, C38, C39, C40, C41, C42, C43, C44, C45, C46, C57, C60, C61	CAP CER 0.1uF 16V 10% X7R SMD 0402	Murata	GRM155R71C104KA88D
14	C34, C47, C48, C49, C50, C51, C52, C53, C54, C55, C56, C58, C59, C67	CAP CER 0.01uF 16V 10% X7R SMD 0402	KEMET	C0402C103K4RACTU
1	C6	CAP CER 2.2uF 10V 10% X5R SMD 0402	Murata	GRM155R61A225KE95D
2	J1, J2	100 pin Recept, Center Strip SMD (P0.4mm)	Hirose Electric Co Ltd	DF40HC(3.0)-100DS-0.4V(58)
3	L1, L2, L3	FERRITE CHIP 100 OHM 2A 0603	TDK Corporation	MPZ1608Y101B
1	LD2	DIO LED GREEN 1.7V 20mA SMD 0603	OSRAM	LG L29K-G2J1-24-Z
1	R2	RES TKF 10k 5% 1/10W SMD 0402	Panasonic	ERJ-2GEJ103X-T
2	R8, R9	RES SMD 1K OHM 1% 1/16W 0402	Stackpole Inc.	RMCF0402FT1K00
1	R11	RES TKF 470R 5% 1/16W SMD 0402	Panasonic	ERJ-2GEJ471X
2	R12, R17	RES TKF 0R SMD 0402	Panasonic	ERJ-2GE0R00X
1	R14	RES TKF 1.5k 5% 1/16W SMD 0402	Rohm Semiconductor	MCR01MRTJ152
1	R15	RES TKF 2.2k 1% 1/10W SMD 0402	Panasonic	ERJ-2RKF2201X
1	Y1	OSC MEMS 24.000 MHZ SMD	Abracon Corporation	ASDMB-24.000MHZ-LC-T
1	U1	PIC32MZ 169BGA Non-crptyo	Microchip Technology	PIC32MZ2064DAH169-I/BG
DNP	C3, C4	CAP CER 8pF 50V 0.5pF C0G SMD 0603	Murata	GRM1885C1H8R0DZ01D
DNP	L4	FERRITE CHIP 100 OHM 2A 0603	TDK Corporation	MPZ1608Y101B
DNP	R1	RES TKF 1M 1% 1/16W SMD 0402	Yageo	RC0402FR-071ML
DNP	Y3	CRYSTAL 24MHz 18pF SMD ABM7	Abracon LLC	ABM7-24.000MHZ-D2Y-T
DNP	TP24	TEST POINT PC MINI .040"D RED	Keystone Electronics	5000
DNP	TP25	TEST POINT PC MINI .040"D BLACK	Keystone Electronics	5001
DNP	Y2	OSC XO 32.768KHZ CMOS SMD	CTS-Frequency Controls	TC25L5I32K7680
DNP	TP1, TP2	CON TP TAB Silver Mini 3.8x2.03 SMD	Keystone Electronics	5019

# PIC32MZ DA Family Starter Kit User's Guide

## B.3 PIC32MZ DA SK BASE BOARD BILL OF MATERIALS

TABLE B-3: PIC32MZ DA SK BASE BOARD BILL OF MATERIALS

Quantity	Reference	Description	Manufacturer	Part No.
1	C12	CAP CER 0.01uF 16V 10% X7R SMD 0402	KEMET	C0402C103K4RACTU
17	C1, C2, C6, C8, C11, C13, C14, C15, C16, C19, C20, C21, C22, C23, C27, C29, C31	CAP CER 0.1uF 16V 10% X7R SMD 0402	Murata	GRM155R71C104KA88D
3	C4, C24, C28	CAP CER 1uF 10V 10% X5R 0402	Murata	GRM155R61A105KE15D
2	C7, C18	CAP CER 10uF 10V 20% X5R SMD 0603	Panasonic	ECJ-1VB1A106M
3	C9, C10, C32	CAP CER 100uF 10V 20% X5R SMD 1206	TDK Corporation	C3216X5R1A107M160AC
1	C30	CAP CER 4.7uF 6.3V 20% X5R SMD 0402	Murata	GRM155R60J475ME47D
3	C3, C5, C17	CAP CER 2.2uF 10V 10% X5R 0402	Murata	GRM155R61A225KE95D
2	C25, C26	CAP CER 8.2pF 50V 0.25pF NP0 0402	Johanson Technology Inc	500R07S8R2CV4T
2	J1, J2	CONN HDR 100POS 0.4MM SMD GOLD	Hirose Electric Co Ltd	DF40C-100DP-0.4V(51)
1	J3	CONN HEADER 168POS W/POST SMD	Hirose Electric Co Ltd	FX10A-168P-SV1(71)
4	J4, J5, J6, J19	CON USB2.0 MICRO-B FEMALE TH/SMD R/A	FCI	10118194-0001LF
1	J7	CON USB USB-A Female SMD R/A	ASSMANN Electronic	AU-Y1006-R
1	J8	CON HDR-2.54 Male 1x2 Gold 5.84MH TH VERT	FCI	77311-118-02LF
2	J9	MOD LAN8740 PHY Daughter Board	Sullins Connector Solutions	LPPB121NFFN-RC
2	@J9	3 Position Header Connector 0.050" (1.27mm) Through Hole Gold	Sullins Connector Solutions	LPPB031NFFN-RC
1	J10	MICRO SD PUSH/PUSH SMALL 8C	Molex, LLC	5033981892
1	J17	HDR_JMPR_2X2_TH_0.05"	Samtec	FTS-102-01-F-D
1	@J17	CONN JUMPER SHORTING 1.27MM GOLD	Sullins Connector Solutions	NPB02DVFN-RC
3	D4, D7, D9	DIO LED GREEN 2.1V 20mA 2.4mcd Diffuse SMD 0603	Stanley Electric Co	BG1111C-TR
1	D8	DIO LED YELLOW 2.2V 25mA 3.4mcd Diffuse SMD 0603	Stanley Electric Co	AY1111C-TR
1	D6	DIO LED RED 1.7V 25mA 11.7mcd Diffuse SMD 0603	Stanley Electric Co	BR1111C-TR
3	D3, D13, D14	DIODE SCHOTTKY 30V 2A SOD123L	ON Semiconductor	MBR230LSFT1G
3	S1, S2, S3	SWITCH TACTILE SPST-NO 0.05A 12V	C&K Components	PTS635SK25SMTR LFS
1	TP3	MISC, TEST POINT MULTI PURPOSE MINI BLACK	Keystone	5001
2	TP1, TP2	MISC, TEST POINT MULTI PURPOSE MINI RED	Keystone	5000
1	Y2	CRYSTAL 12MHz 8pF SMD NX3225SA	NDK	NX3225SA-12.000000MHZ
1	Y1	OSC MEMS 50.000 MHz_1.8V~3.3V SMD	Abrakon Corporation	ASEMB-50.000MHZ-LC-T
3	R3, R10, R49	RES TKF 100k 1% 1/10W SMD 0402	Panasonic	ERJ-2RKF1003X
1	R50	RES TKF 1k 1% 1/10W SMD 0402	Panasonic	ERJ-2RKF1001X
3	R45, R53, R54	RES TKF 2.2k 1% 1/10W SMD 0402	Panasonic	ERJ-2RKF2201X

# Bill of Materials

Quantity	Reference	Description	Manufacturer	Part No.
10	R6, R16, R28, R29, R35, R38, R39, R46, R66, R90	RES TKF 330R 5% 1/10W SMD 0402	Panasonic	ERJ-2GEJ331X
1	R41	RES TKF 200k 1% 1/10W SMD 0402	Panasonic	ERJ-2RKF2003X
5	R4, R14, R15, R31, R32	RES TKF 33R 1% 1/16W SMD 0402	Rohm Semiconductor	MCR01MRTF33R0
5	R2, R36, R40, R85, R86	RES TKF 4.7k 5% 1/10W SMD 0402	Panasonic	ERJ-2GEJ472X
22	R9, R17, R18, R19, R20, R21, R30, R37, R42, R43, R44, R47, R52, R57, R60, R62, R68, R69, R67, R83, R88, R89	RES TKF 10k 1% 1/10W SMD 0402	Panasonic	ERJ-2RKF1002X
2	R51, R58	RES TKF 100R 5% 1/16W SMD 0402	Yageo	RC0402JR-07100RL
11	R1, R12, R13, R33, R55, R78, R79, R80, R81, R82, R84	RES TKF 0R 1/16W SMD 0402	Yageo	RC0402JR-070RL
1	R56	RES SMD 3.16K OHM 1% 1/10W 0402	Panasonic	ERJ-2RKF3161X
1	R48	RES TKF 3.92K 1% 1/16W SMD 0402	Yageo	RC0402FR-073K92L
1	U3	IC BILATERAL SWITCH DUAL SM8	Toshiba	+E14
1	U9	IC SWITCH SPDT SC70-6	Fairchild Semiconductor	NC7SB3157P6X
1	U11	IC PWR DIST SWITCH SNGL SOT23-5	Texas Instruments	TPS2041BDBVRG4
2	Q3, Q4	TRANS BJT NPN MMBT3904 40V 200mA 310mW SOT-23-3	Diodes Incorporated	MMBT3904-7
1	Q2	TRANS BJT PNP MMBT3906 -40V -200mA 300mW SOT-23-3	Central Semiconductor	CMPT3906-PST-LEADFREE
1	Q1	TRANS BJT NPN MMBT2222 30V 600mA 350mW SOT-23-3	Fairchild Semiconductor	MMBT2222
1	Rubber Foot	BUMPER SQUARE BLK (L10.5xW10.5xH2.5mm)	3M	SJ-5007
1	U8	MCHP MEMORY SERIAL EEPROM 256k SPI 25LC256-I/SN SOIC-8	Microchip Technology	25LC256T-I/SN
1	U6	MCHP ANALOG LDO 3.3V MCP1700T-3302E/TT SOT-23-3	Microchip Technology	MCP1700T-3302E/TT
1	U2	MCHP ANALOG LDO 3.3V MCP1727-3302E/SN SOIC-8	Microchip Technology	MCP1727-3302E/SN
1	U5	IC FLASH 32MBIT 8QFN_Modified Pads	Microchip Technology	SST26VF032BT-104I/SM
1	U7	PIC® IC 16-Bit 32MHz 256KB 64-TQFP (10x10)	Microchip Technology	PIC24FJ256GB106-I/PT
1	U4	LDO 1.8V 1A_10MLF (3x3)	Microchip Technology	MIC69101-1.8YML-TR
1	U1	MCHP INTERFACE USB I2C UART MCP2221-I/ST TSSOP-14	Microchip Technology	MCP2221-I/ST
DNP	R11, R59, R61, R87, R70, R84, R71			
DNP	R22, R23, R24, R25, R26, R27			

# PIC32MZ DA Family Starter Kit User's Guide

---

Quantity	Reference	Description	Manufacturer	Part No.
DNP	D11	DIODE GEN PURP 75V 150MA 0402	Comchip Technology	CDSQR4148-HF
DNP	J11	Terminal Strip, Dual Row Horizontal, Surface Mount, 0.100" Pitch, 14 Pins		
DNP	J15	CON HDR-2.54 Male 2x20 Gold 5.84MH TH VERT	Samtec	TSW-120-07-G-D
DNP	J12, J18	CON HDR-1.27 Female 1x6 Gold TH VERT	Samtec	SLM-106-01-G-S

## B.4 LAN8740A PHY DAUGHTER BOARD BILL OF MATERIALS

**TABLE B-4: LAN8740A PHY DAUGHTER BOARD BILL OF MATERIALS**

Quantity	Reference	Description	Manufacturer	Part No.
4	C1, C3, C7, C8	Cap, Ceramic, 1 $\mu$ F, 16V X5R	TDK Corporation	C1608X5R1C105K
4	C2, C4, C5, C6	Cap, Ceramic, 0.1 $\mu$ F, 50V X7R	TDK Corporation	C1608X7R1H104M
1	C9	CAP 470 $\mu$ F 50V CERAMIC X7R 0603	Yageo	CC0603KRX7R9BB471
1	C14	CAP CER 0.022 $\mu$ F 50V 20% X7R 0603	Murata	GRM188R71H223MA01D
1	FB1	FERRITE CHIP 600 OHM 500 mA 0805	TDK Corporation	MMZ2012Y601B
2	J1	TWO CONN HEADER .050" 12 POS PCB GOLD	Sullins Connector	GRPB121VWVN-RC
2	@J1	TWO CONN HEADER .050" 3 POS PCB GOLD	Sullins Connector	GRPB031VWVN-RC
1	J2	CONN MAGJACK 1 PORT 100 BASE-TX	Pulse	J3011G21DNL
6	R1, R2, R3, R4, R6, R8	RES 4.70K OHM 1/10W 1% 0603 SMD	Panasonic - ECG	ERJ-3EKF4701V
2	R5, R16	RES 10K OHM 1/10W 1% 0603 SMD	Stackpole Inc.	RMCF0603FT10K0
1	R7	RES 1.50K OHM 1/10W 1% 0603 SMD	Vishay Dale	CRCW06031K50FKEA
4	R11, R12, R13, R14	RES 33 OHM 1/10W 1% 0603 SMD	Stackpole Inc.	RMCF0603FT33R0
1	R15	RES 12.1K OHM 1/10W 1% 0603 SMD	Stackpole Inc.	RMCF0603FT12K1
4	R17, R18, R19, R20	RES TF 1/10W 49.9 OHM 1% 0603	Stackpole Inc.	RMCF0603FG49R9
2	R21, R22	RES TF 1/10W 249 OHM 1% 0603	Stackpole Inc.	RMCF0603FG249R
1	R23	RES 0.0 OHM 1/4W 0805 SMD	Yageo	RC0805JR-070RL
1	U1	TX/RX Ethernet 32-pin QFN	Microchip Technology	LAN8740A-EN
DNP	C10, C11, C12, C13	CAP CER 12 $\mu$ F 50V 5% NPO 0603	Yageo	CC0603JRNPO9BN120
DNP	R24	DNP (0603 pads)		



# MICROCHIP

## Worldwide Sales and Service

### AMERICAS

**Corporate Office**  
2355 West Chandler Blvd.  
Chandler, AZ 85224-6199  
Tel: 480-792-7200  
Fax: 480-792-7277  
Technical Support:  
<http://www.microchip.com/support>  
Web Address:  
[www.microchip.com](http://www.microchip.com)

**Atlanta**  
Duluth, GA  
Tel: 678-957-9614  
Fax: 678-957-1455

**Austin, TX**  
Tel: 512-257-3370

**Boston**  
Westborough, MA  
Tel: 774-760-0087  
Fax: 774-760-0088

**Chicago**  
Itasca, IL  
Tel: 630-285-0071  
Fax: 630-285-0075

**Cleveland**  
Independence, OH  
Tel: 216-447-0464  
Fax: 216-447-0643

**Dallas**  
Addison, TX  
Tel: 972-818-7423  
Fax: 972-818-2924

**Detroit**  
Novi, MI  
Tel: 248-848-4000

**Houston, TX**  
Tel: 281-894-5983

**Indianapolis**  
Noblesville, IN  
Tel: 317-773-8323  
Fax: 317-773-5453

**Los Angeles**  
Mission Viejo, CA  
Tel: 949-462-9523  
Fax: 949-462-9608

**New York, NY**  
Tel: 631-435-6000

**San Jose, CA**  
Tel: 408-735-9110

**Canada - Toronto**  
Tel: 905-673-0699  
Fax: 905-673-6509

### ASIA/PACIFIC

**Asia Pacific Office**  
Suites 3707-14, 37th Floor  
Tower 6, The Gateway  
Harbour City, Kowloon

**Hong Kong**  
Tel: 852-2943-5100  
Fax: 852-2401-3431

**Australia - Sydney**  
Tel: 61-2-9868-6733  
Fax: 61-2-9868-6755

**China - Beijing**  
Tel: 86-10-8569-7000  
Fax: 86-10-8528-2104

**China - Chengdu**  
Tel: 86-28-8665-5511  
Fax: 86-28-8665-7889

**China - Chongqing**  
Tel: 86-23-8980-9588  
Fax: 86-23-8980-9500

**China - Dongguan**  
Tel: 86-769-8702-9880

**China - Guangzhou**  
Tel: 86-20-8755-8029

**China - Hangzhou**  
Tel: 86-571-8792-8115  
Fax: 86-571-8792-8116

**China - Hong Kong SAR**  
Tel: 852-2943-5100  
Fax: 852-2401-3431

**China - Nanjing**  
Tel: 86-25-8473-2460  
Fax: 86-25-8473-2470

**China - Qingdao**  
Tel: 86-532-8502-7355  
Fax: 86-532-8502-7205

**China - Shanghai**  
Tel: 86-21-3326-8000  
Fax: 86-21-3326-8021

**China - Shenyang**  
Tel: 86-24-2334-2829  
Fax: 86-24-2334-2393

**China - Shenzhen**  
Tel: 86-755-8864-2200  
Fax: 86-755-8203-1760

**China - Wuhan**  
Tel: 86-27-5980-5300  
Fax: 86-27-5980-5118

**China - Xian**  
Tel: 86-29-8833-7252  
Fax: 86-29-8833-7256

### ASIA/PACIFIC

**Asia Pacific Office**  
Suites 3707-14, 37th Floor  
Tower 6, The Gateway  
Harbour City, Kowloon

**Hong Kong**  
Tel: 852-2943-5100  
Fax: 852-2401-3431

**Australia - Sydney**  
Tel: 61-2-9868-6733  
Fax: 61-2-9868-6755

**China - Beijing**  
Tel: 86-10-8569-7000  
Fax: 86-10-8528-2104

**China - Chengdu**  
Tel: 86-28-8665-5511  
Fax: 86-28-8665-7889

**China - Chongqing**  
Tel: 86-23-8980-9588  
Fax: 86-23-8980-9500

**China - Dongguan**  
Tel: 86-769-8702-9880

**China - Guangzhou**  
Tel: 86-20-8755-8029

**China - Hangzhou**  
Tel: 86-571-8792-8115  
Fax: 86-571-8792-8116

**China - Hong Kong SAR**  
Tel: 852-2943-5100  
Fax: 852-2401-3431

**China - Nanjing**  
Tel: 86-25-8473-2460  
Fax: 86-25-8473-2470

**China - Qingdao**  
Tel: 86-532-8502-7355  
Fax: 86-532-8502-7205

**China - Shanghai**  
Tel: 86-21-3326-8000  
Fax: 86-21-3326-8021

**China - Shenyang**  
Tel: 86-24-2334-2829  
Fax: 86-24-2334-2393

**China - Shenzhen**  
Tel: 86-755-8864-2200  
Fax: 86-755-8203-1760

**China - Wuhan**  
Tel: 86-27-5980-5300  
Fax: 86-27-5980-5118

**China - Xian**  
Tel: 86-29-8833-7252  
Fax: 86-29-8833-7256

### EUROPE

**Austria - Wels**  
Tel: 43-7242-2244-39  
Fax: 43-7242-2244-393

**Denmark - Copenhagen**  
Tel: 45-4450-2828  
Fax: 45-4485-2829

**Finland - Espoo**  
Tel: 358-9-4520-820

**France - Paris**  
Tel: 33-1-69-53-63-20  
Fax: 33-1-69-30-90-79

**France - Saint Cloud**  
Tel: 33-1-30-60-70-00

**Germany - Garching**  
Tel: 49-8931-9700

**Germany - Haan**  
Tel: 49-2129-3766400

**Germany - Heilbronn**  
Tel: 49-7131-67-3636

**Germany - Karlsruhe**  
Tel: 49-721-625370

**Germany - Munich**  
Tel: 49-89-627-144-0  
Fax: 49-89-627-144-44

**Germany - Rosenheim**  
Tel: 49-8031-354-560

**Israel - Ra'anana**  
Tel: 972-9-744-7705

**Italy - Milan**  
Tel: 39-0331-742611  
Fax: 39-0331-466781

**Italy - Padova**  
Tel: 39-049-7625286

**Netherlands - Drunen**  
Tel: 31-416-690399  
Fax: 31-416-690340

**Norway - Trondheim**  
Tel: 47-7289-7561

**Poland - Warsaw**  
Tel: 48-22-3325737

**Romania - Bucharest**  
Tel: 40-21-407-87-50

**Spain - Madrid**  
Tel: 34-91-708-08-90  
Fax: 34-91-708-08-91

**Sweden - Gothenberg**  
Tel: 46-31-704-60-40

**Sweden - Stockholm**  
Tel: 46-8-5090-4654

**UK - Wokingham**  
Tel: 44-118-921-5800  
Fax: 44-118-921-5820

11/07/16