

Part Number: D3I0810S

Electrical Specifications

Frequency Range (GHz):	0.8 – 1.0
Isolation (dB):	20 MIN
Insertion Loss (dB):	0.4 MAX
VSWR:	1.25:1 MIN
Forward Power (W):	250 AVG 750 PK
Reflective Power (W):	10 AVG

Mechanical/Environmental Specifications

Connector Type:	SMA
Connector Body:	Passivated stainless steel
Connector Pin:	Gold plated copper
Load Body:	Brass
Magnetic Shunt:	Nickel plated CRS
Operational Temp:	-20°C to +65°C
Weight (oz)	2.8 MAX

D3I0810S Dimensions

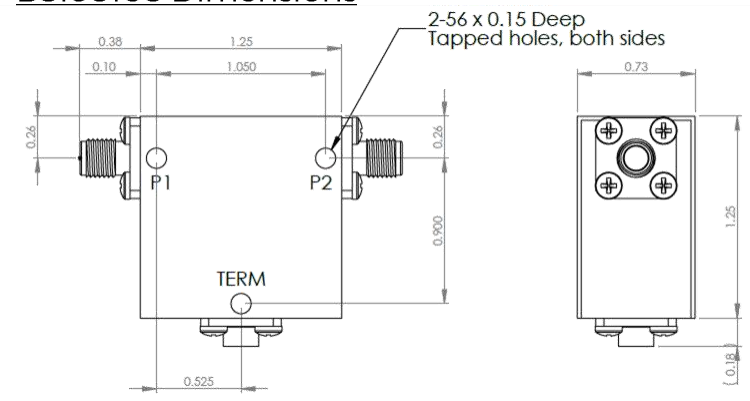

D3I0810S-3 Dimensions

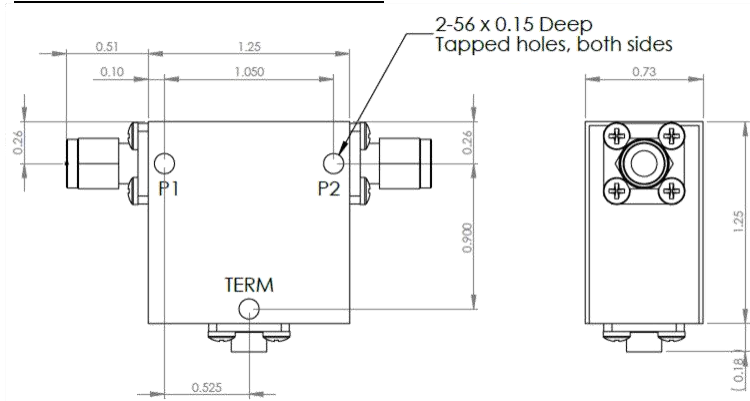

Dimensions are in inches
Tolerance

XX	±0.03
XXX	±0.010

Type of Device	PN Suffix	Connector Configuration Input / Output	PN Example
Single and Dual Junction Isolator, 2-Port Device	N/A	Female / Female	D3I0810S
	-1	Male / Female	D3I0810S-1
	-2	Female / Male	D3I0810S-2
	-3	Male / Male	D3I0810S-3



MEASURED DATA

Part Number: D3I0810S, +25°C

