

G13LOC-P03LTQ0-0000 series_l, type_g1

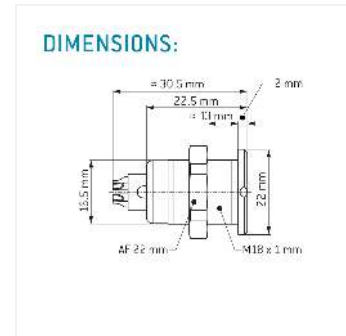

General information

Part number	G13LOC-P03LTQ0-0000
Termination	solder
Size	3
Locking principle	break , push
Coding	0_key

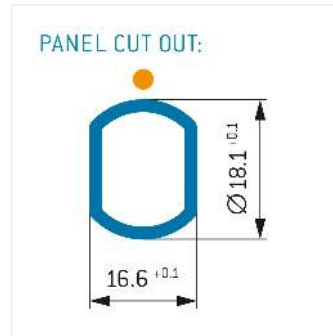
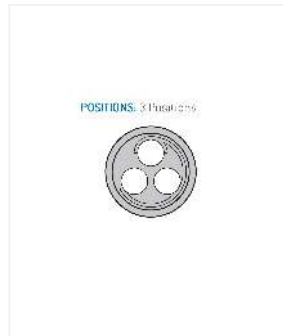
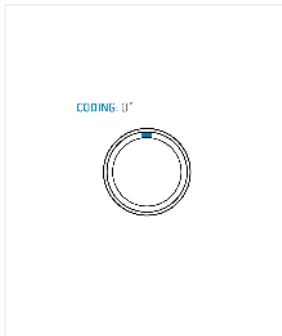

Contact insert description

Number of contacts	3
Contact type	sockets
Contact diameter	20mm
Insulator material	peek
Wire cross section	14_awg
Termination	solder
Termination diameter	185mm

reverse_gender_on_request

Technical information

Max. creepage and air clearance distance	20_mm	17_mm
Nominal current single contact	18_a	iec_60512_5_2
Nominal current insert	18 A	vde_0298_4
Test voltage	18_kv_ac	sae_13441

safety_text

Mechanical and environmental data

Degree of protection*	ip50
Operating temperature	40_120_c
Mating cycles	5000

mated_unmated

Material and surface treatments

Housing	m_chrome
Contact	cu_alloy_gold

safety_text_2
ul_text
illustrative_text