

PAGE 1/2	ISSUE 10-10-18B	SERIES ATTENUATOR	PART NUMBER R420710110
----------	-----------------	-----------------------------	-------------------------------

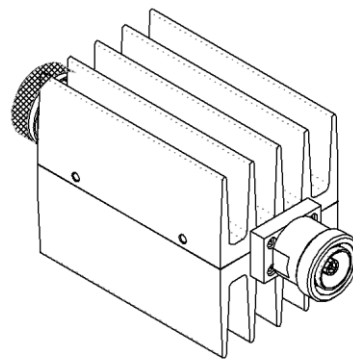

All dimensions are in mm. Tolerances according ISO 2768 m-H

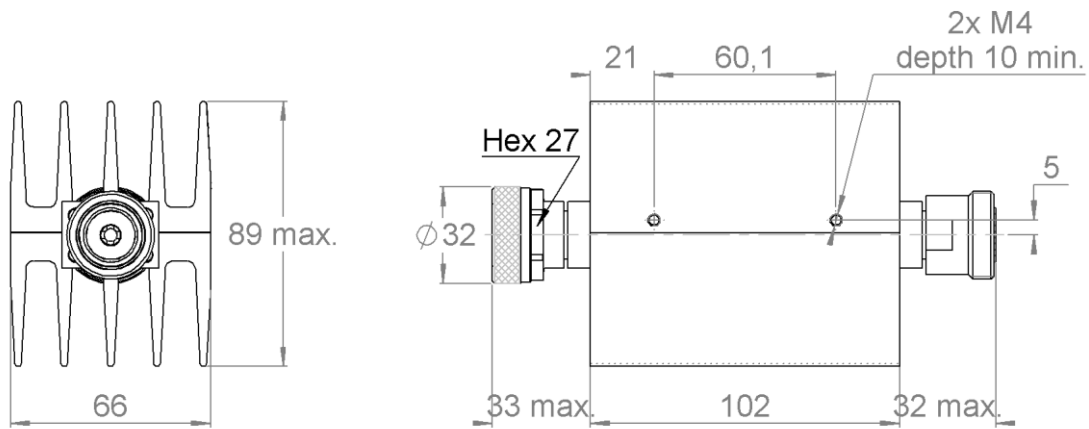

COMPONENTS	MATERIALS	PLATING (μm)
Body	BRASS	BBR 3
Male center contact	BERYLLIUM COPPER	GOLD 0.5 OVER NICKEL PHOSPHORUS 2
Female center contact	BERYLLIUM COPPER	GOLD 0.5 OVER NICKEL PHOSPHORUS 2
Outer contact	BRASS	BBR 0.5 OVER SILVER 5
Insulator	PTFE	
Gasket	SILICONE RUBBER	
Substrate	ALUMINA	
Resistor	THICK FILM	
Others parts	ALUMINIUM	BLACK PAINTING

PAGE 2/2	ISSUE 10-10-18B	SERIES ATTENUATOR	PART NUMBER R420710110
----------	------------------------	-----------------------------	-------------------------------

ELECTRICAL CHARACTERISTICS

Frequency (GHz)	DC - 1	1 - 2	2 - 3
V.S.W.R (≤)	1.10	1.25	1.30
Deviation(±dB)	1	1	1.5

Operating Frequency Range	DC - 3	GHz
Impedance	50	Ω
Nominal Attenuation	10	dB
Peak power at 25°C (1μs, 1%)	5000	W
Average power at 25°C	100	W (Free Air Cooled)
		W (Conduction Cooled)

MECHANICAL CHARACTERISTICS

Connectors	7-16	Male Female	IEC 169-4
Weight	870,4900 g		

ENVIRONMENTAL CHARACTERISTICS

Operating temperature range	-55 /+125 °C
Storage temperature range	-55 /+125 °C

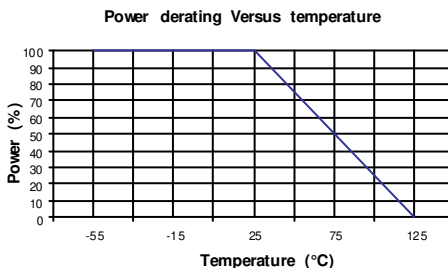

SPECIFICATION

OTHER CHARACTERISTICS