

BLF4G10-160

UHF power LDMOS transistor

Rev. 01 — 22 June 2007

Product data sheet

1. Product profile

1.1 General description

160 W LDMOS power transistor for base station applications at frequencies from 800 MHz to 1000 MHz.

Table 1. Typical performance

RF performance at $T_{case} = 25^{\circ}\text{C}$ in a common source class-AB test circuit.

Mode of operation	f (MHz)	V _{DS} (V)	P _L (W)	P _{L(AV)} (W)	G _p (dB)	η_D (%)	ACPR ₄₀₀ (dBc)	ACPR ₆₀₀ (dBc)	ACPR ₇₅₀ (dBc)	ACPR ₁₉₈₀ (dBc)	EVM _{rms} (%)	IMD3 (dBc)
CW	894	28	200	-	19.0	59	-	-	-	-	-	-
2-tone	894	28	-	80	19.7	42.5	-	-	-	-	-	-29
GSM EDGE	894	28	-	80	19.7	41.5	-61 ^[1]	-72 ^[1]	-	-	3.0	-
CDMA	881.5	28	-	40	19.0	29.5	-	-	-45 ^[2]	-64 ^[2]	-	-

[1] ACPR₄₀₀ and ACPR₆₀₀ at 30 kHz resolution bandwidth.

[2] Test signal: IS-95, with PAR = 9.9 dB at 0.01 % probability.

CAUTION



This device is sensitive to ElectroStatic Discharge (ESD). Therefore care should be taken during transport and handling.

1.2 Features

- Typical GSM EDGE performance at $f = 894$ MHz, $V_{DS} = 28$ V and $I_{Dq} = 900$ mA:
 - ◆ Average output power = 80 W
 - ◆ Gain = 19.7 dB
 - ◆ Efficiency = 41.5 %
 - ◆ ACPR₄₀₀ = -61 dBc
 - ◆ ACPR₆₀₀ = -72 dBc
 - ◆ EVM_{rms} = 3.0 %
- Easy power control
- Excellent ruggedness
- High efficiency
- Excellent thermal stability
- Designed for broadband operation (800 MHz to 1000 MHz)
- Internally matched for ease of use

1.3 Applications

- RF power amplifiers for GSM, GSM EDGE and CDMA base stations and multi carrier applications in the 800 MHz to 1000 MHz frequency range.

2. Pinning information

Table 2. Pinning

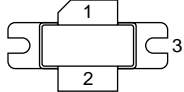
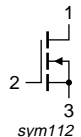
Pin	Description	Simplified outline	Symbol
1	drain		
2	gate		
3	source		

[1] Connected to flange

3. Ordering information

Table 3. Ordering information

Type number	Package		
	Name	Description	Version
BLF4G10-160	-	flanged LDMOST ceramic package; 2 mounting holes; 2 leads	SOT502A

4. Limiting values

Table 4. Limiting values

In accordance with the Absolute Maximum Rating System (IEC 60134).

Symbol	Parameter	Conditions	Min	Max	Unit
V_{DS}	drain-source voltage		-	65	V
V_{GS}	gate-source voltage		-0.5	+15	V
I_D	drain current		-	15	A
T_{stg}	storage temperature		-65	+150	°C
T_j	junction temperature		-	200	°C

5. Thermal characteristics

Table 5. Thermal characteristics

Symbol	Parameter	Conditions	Typ	Max	Unit
$R_{th(j-case)}$	thermal resistance from junction to case	$T_{case} = 80\text{ °C};$ $P_L = 50\text{ W}$	0.55	0.64	K/W

6. Characteristics

Table 6. Characteristics

$T_j = 25\text{ }^\circ\text{C}$; unless otherwise specified.

Symbol	Parameter	Conditions	Min	Typ	Max	Unit
$V_{(BR)DSS}$	drain-source breakdown voltage	$V_{GS} = 0\text{ V}$; $I_D = 2.1\text{ mA}$	65	-	-	V
$V_{GS(th)}$	gate-source threshold voltage	$V_{DS} = 10\text{ V}$; $I_D = 230\text{ mA}$	2.5	2.9	3.5	V
V_{GSq}	gate-source quiescent voltage	$V_{DS} = 28\text{ V}$; $I_D = 900\text{ mA}$	2.65	3.15	3.65	V
I_{DSS}	drain leakage current	$V_{GS} = 0\text{ V}$; $V_{DS} = 28\text{ V}$	-	-	5	μA
I_{DSX}	drain cut-off current	$V_{GS} = V_{GS(th)} + 6\text{ V}$; $V_{DS} = 10\text{ V}$	35	42	-	A
I_{GSS}	gate leakage current	$V_{GS} = 15\text{ V}$; $V_{DS} = 0\text{ V}$	-	-	420	nA
g_{fs}	forward transconductance	$V_{DS} = 10\text{ V}$; $I_D = 7.5\text{ A}$	-	11	-	S
$R_{DS(on)}$	drain-source on-state resistance	$V_{GS} = V_{GS(th)} + 6\text{ V}$; $I_D = 7.5\text{ A}$	-	0.065	-	Ω
C_{rs}	feedback capacitance	$V_{GS} = 0\text{ V}$; $V_{DS} = 28\text{ V}$; $f = 1\text{ MHz}$	-	3.0	-	pF

7. Application information

Table 7. Application information

Mode of operation: 2-tone; $f_1 = 894\text{ MHz}$; $f_2 = 894.2\text{ MHz}$; RF performance at $V_{DS} = 28\text{ V}$;
 $I_{Dq} = 900\text{ mA}$; $T_{case} = 25\text{ }^\circ\text{C}$; unless otherwise specified; in a class-AB test circuit.

Symbol	Parameter	Conditions	Min	Typ	Max	Unit
G_p	power gain	$P_{L(PEP)} = 160\text{ W}$	18.5	19.7	-	dB
RL_{in}	input return loss	$P_{L(PEP)} = 160\text{ W}$	-	-10	-6	dB
η_D	drain efficiency	$P_{L(PEP)} = 160\text{ W}$	40	42.5	-	%
IMD3	third order intermodulation distortion	$P_{L(PEP)} = 160\text{ W}$	-	-29	-26	dBc
IMD5	fifth order intermodulation distortion	$P_{L(PEP)} = 160\text{ W}$	-	-38	-35	dBc
IMD7	seventh order intermodulation distortion	$P_{L(PEP)} = 160\text{ W}$	-	-57	-53	dBc

7.1 Ruggedness in class-AB operation

The BLF4G10-160 is capable of withstanding a load mismatch corresponding to $VSWR = 10 : 1$ through all phases under the following conditions: $V_{DS} = 28\text{ V}$;
 $I_{Dq} = 900\text{ mA}$; $P_L = 160\text{ W (CW)}$; $f = 894\text{ MHz}$.

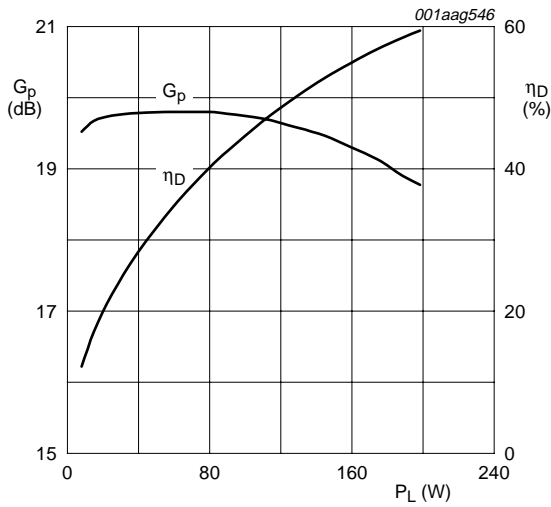

$V_{DS} = 28\text{ V}$; $I_{Dq} = 900\text{ mA}$; $T_{case} = 25\text{ }^{\circ}\text{C}$;
 $f = 894\text{ MHz}$.

Fig 1. One-tone CW power gain and drain efficiency as functions of load power; typical values

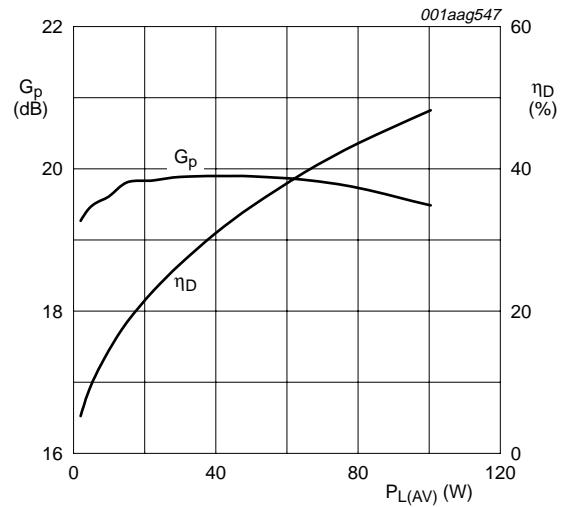

$V_{DS} = 28\text{ V}$; $I_{Dq} = 900\text{ mA}$; $T_{case} = 25\text{ }^{\circ}\text{C}$;
 $f = 894\text{ MHz}$.

Fig 2. Two-tone power gain and drain efficiency as functions of average load power; typical values

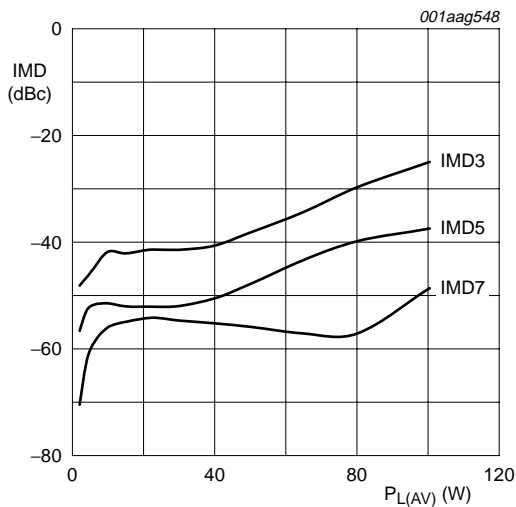

$V_{DS} = 28\text{ V}$; $I_{Dq} = 900\text{ mA}$; $T_{case} = 25\text{ }^{\circ}\text{C}$;
 $f = 894\text{ MHz}$.

Fig 3. Intermodulation distortion a function of average load power; typical values

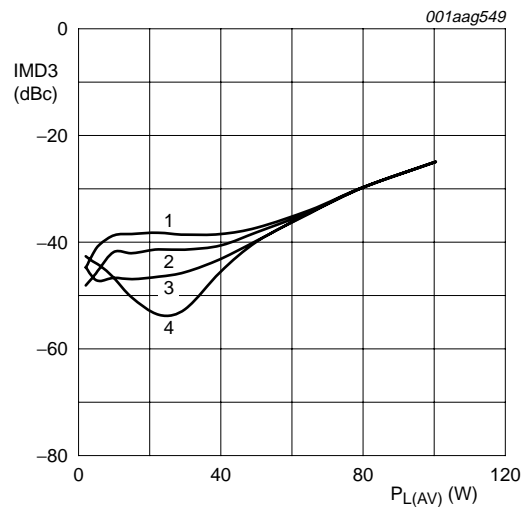

$V_{DS} = 28\text{ V}$; $T_{case} = 25\text{ }^{\circ}\text{C}$; $f = 894\text{ MHz}$.

- (1) $I_{Dq} = 800\text{ mA}$.
- (2) $I_{Dq} = 900\text{ mA}$.
- (3) $I_{Dq} = 1000\text{ mA}$.
- (4) $I_{Dq} = 1100\text{ mA}$.

Fig 4. IMD3 as a function of average load power; typical values

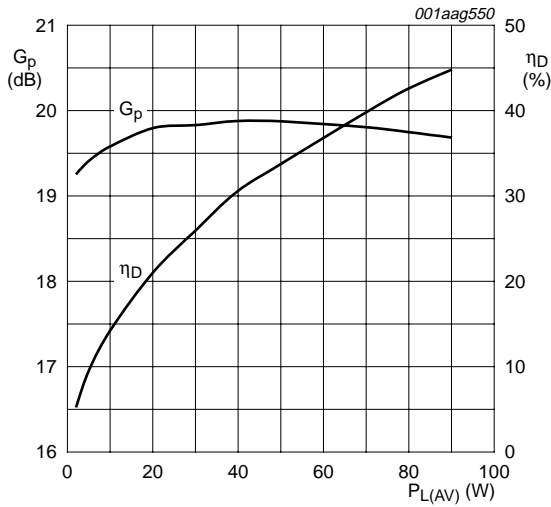

$V_{DS} = 28\text{ V}$; $I_{DQ} = 900\text{ mA}$; $T_{case} = 25\text{ }^\circ\text{C}$;
 $f = 894\text{ MHz}$.

Fig 5. GSM EDGE power gain and drain efficiency as functions of average load power; typical values

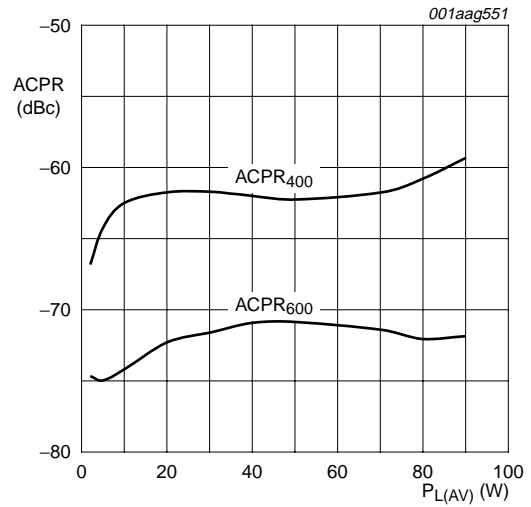

$V_{DS} = 28\text{ V}$; $I_{DQ} = 900\text{ mA}$; $T_{case} = 25\text{ }^\circ\text{C}$;
 $f = 894\text{ MHz}$.

Fig 6. GSM EDGE ACPR at 400 kHz and at 600 kHz as a function of average load power; typical values

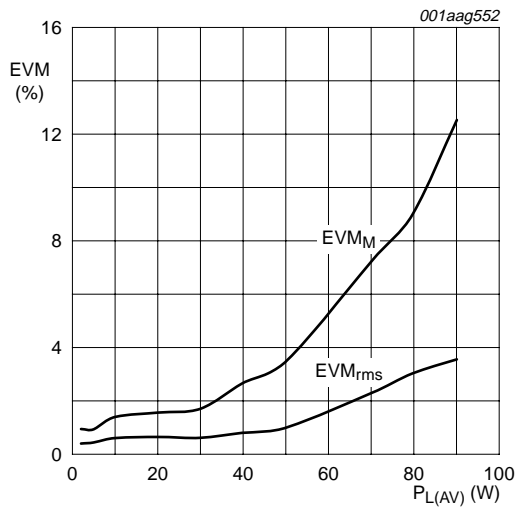

$V_{DS} = 28\text{ V}$; $I_{DQ} = 900\text{ mA}$; $T_{case} = 25\text{ }^\circ\text{C}$;
 $f = 894\text{ MHz}$.

Fig 7. GSM EDGE rms EVM and peak EVM as functions of average load power; typical values

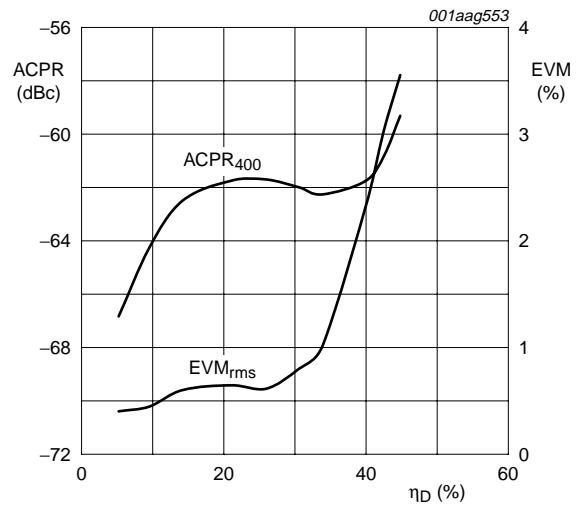

$V_{DS} = 28\text{ V}$; $I_{DQ} = 900\text{ mA}$; $T_{case} = 25\text{ }^\circ\text{C}$;
 $f = 894\text{ MHz}$.

Fig 8. GSM EDGE ACPR and rms EVM as functions of drain efficiency; typical values

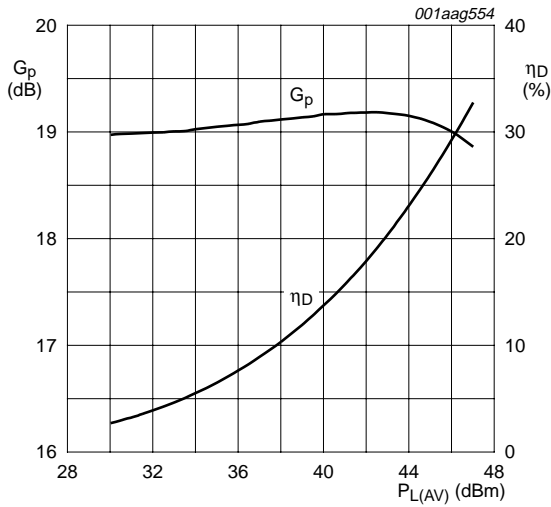

$V_{DS} = 28\text{ V}$; $I_{Dq} = 1100\text{ mA}$; $f = 881.5\text{ MHz}$.
 Test signal: IS-95 with PAR = 9.9 dB at 0.01 % probability.

Fig 9. CDMA power gain and drain efficiency as functions of average load power; typical values, measured in a CDMA demo test circuit

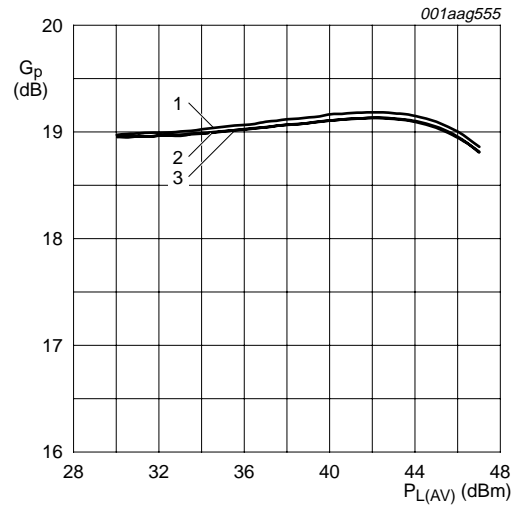

$V_{DS} = 28\text{ V}$; $I_{Dq} = 1100\text{ mA}$.

- (1) $f = 869\text{ MHz}$.
- (2) $f = 881.5\text{ MHz}$.
- (3) $f = 894\text{ MHz}$.

Fig 10. CDMA power gain as a function of average load power at various frequencies; typical values, measured in a CDMA demo test circuit

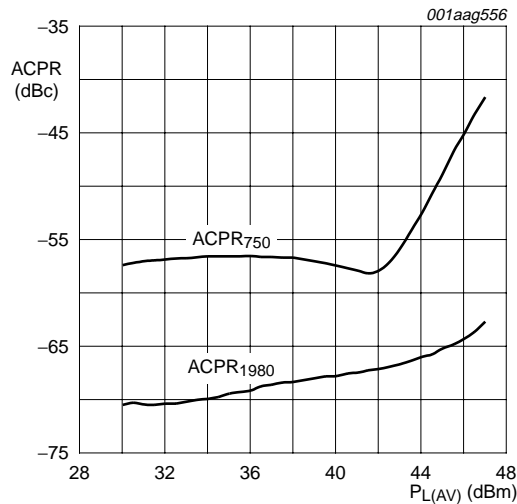

$V_{DS} = 28\text{ V}$; $I_{Dq} = 1100\text{ mA}$; $T_{case} = 25\text{ }^\circ\text{C}$; $f = 881.5\text{ MHz}$.

Fig 11. CDMA ACPR at 750 kHz and at 1980 kHz as functions of average load power; typical values, measured in a CDMA demo test circuit

8. Test information

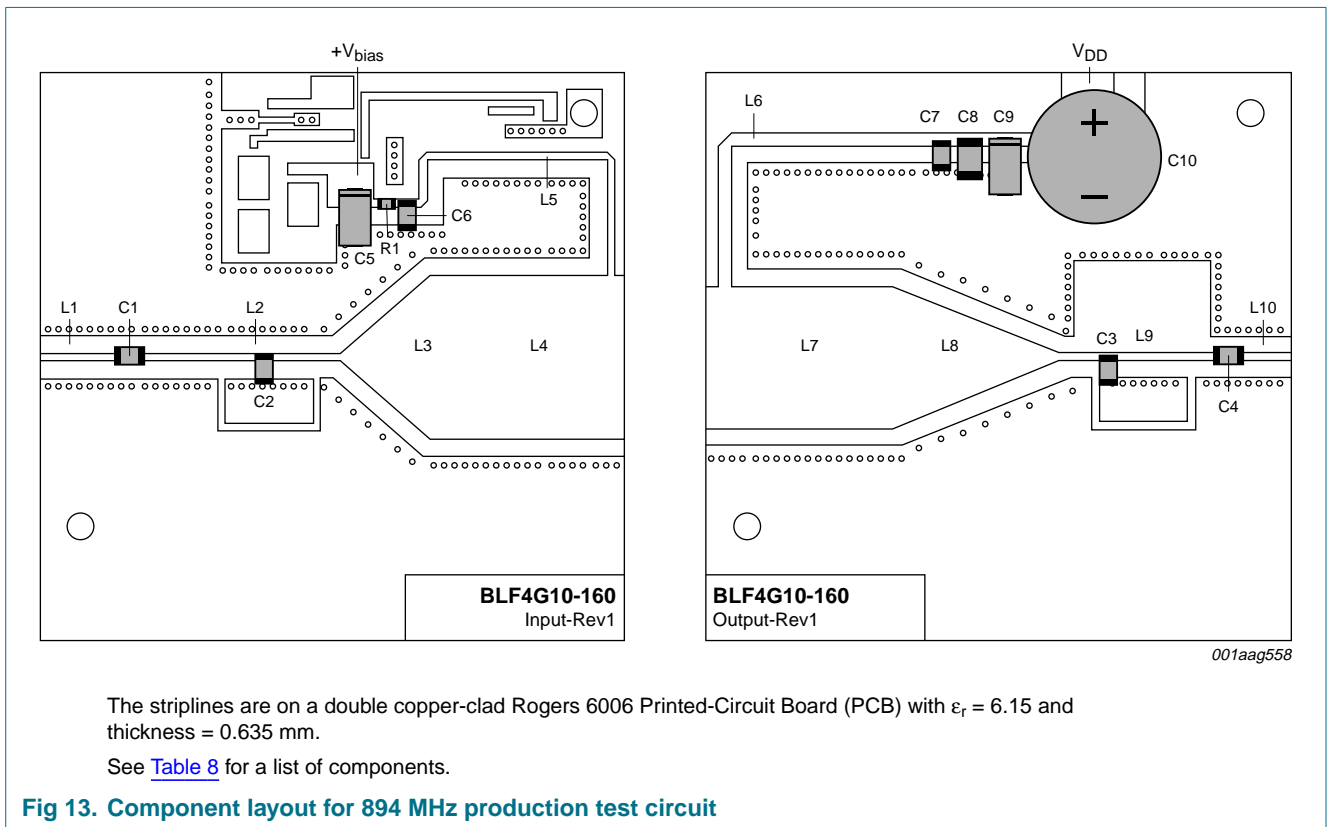
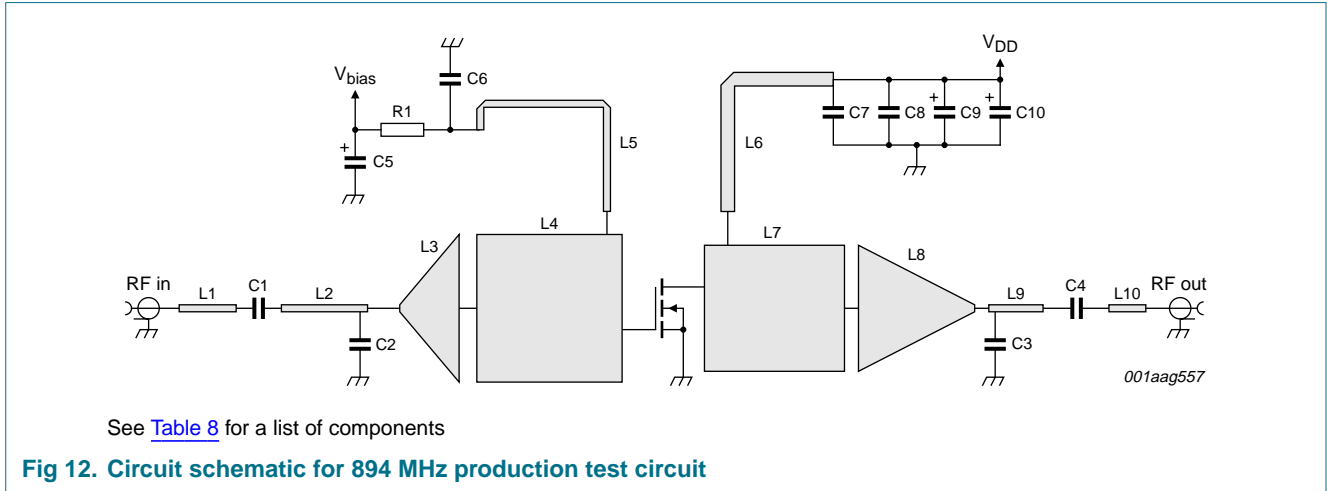

Table 8. List of components (see Figure 12 and Figure 13).

Component	Description	Value	Remarks
C1, C4, C6, C7	multilayer ceramic chip capacitor	68 pF	[1]
C2	multilayer ceramic chip capacitor	1.5 pF	[1]
C3	multilayer ceramic chip capacitor	1.4 pF	[1]
C5, C9	tantalum capacitor	10 μ F	
C8	ceramic capacitor	1 μ F	1812X7R105KL2AB
C10	electrolytic capacitor	220 μ F	
L1	stripline	-	[2] (W \times L) 0.914 mm \times 10.160 mm
L2	stripline	-	[2] (W \times L) 0.914 mm \times 24.384 mm
L3	tapered stripline	-	[2] (W1 \times W2 \times L) 0.914 mm \times 19.812 mm \times 11.024 mm
L4	stripline	-	[2] (W \times L) 19.812 mm \times 21.438 mm
L5	stripline	-	[2] (W \times L) 0.914 mm \times 42.342 mm
L6	stripline	-	[2] (W \times L) 1.524 mm \times 42.418 mm
L7	stripline	-	[2] (W \times L) 17.221 mm \times 22.479 mm
L8	tapered stripline	-	[2] (W1 \times W2 \times L) 17.221 mm \times 0.914 mm \times 20.625 mm
L9	stripline	-	[2] (W \times L) 0.914 mm \times 19.126 mm
L10	stripline	-	[2] (W \times L) 0.914 mm \times 6.858 mm
R1	SMD resistor	5.1 Ω	

[1] American Technical Ceramics type 100B or capacitor of same quality.

[2] The striplines are on a double copper-clad Rogers 6006 Printed-Circuit Board (PCB) with $\epsilon_r = 6.15$ and thickness = 0.635 mm.

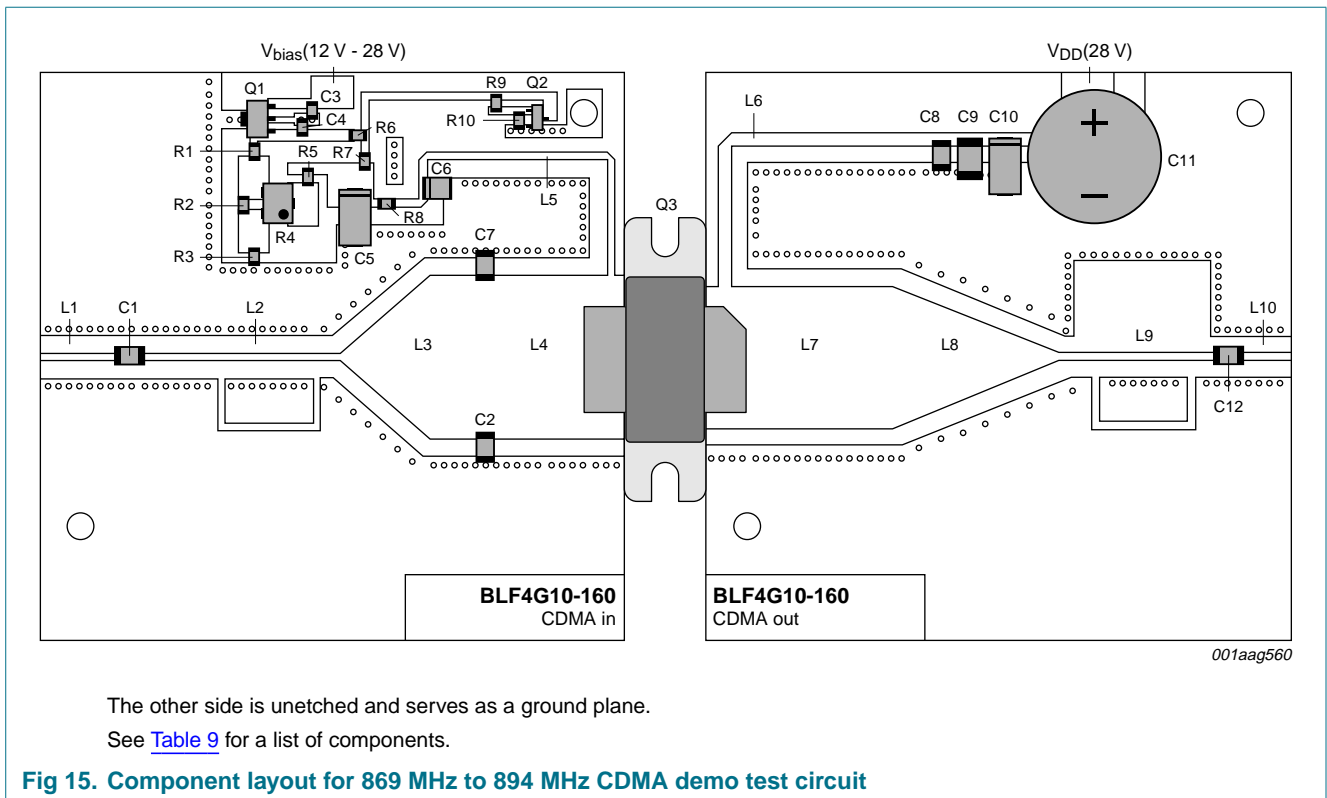
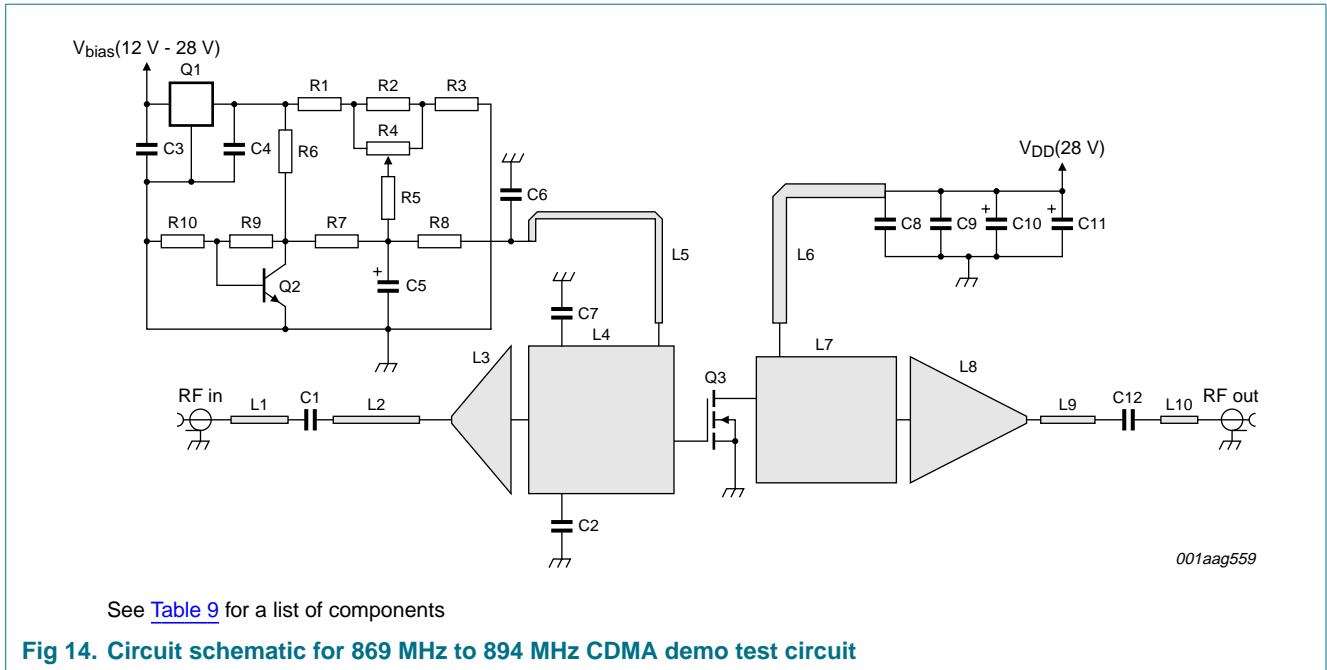

Table 9. List of components (see Figure 14 and Figure 15).

Component	Description	Value	Remarks
C1, C6, C8	multilayer ceramic chip capacitor	68 pF	[1]
C2, C7	multilayer ceramic chip capacitor	1.3 pF	[1]
C3, C4	ceramic capacitor	100 nF	
C5, C10	tantalum capacitor	10 μ F	
C9	ceramic capacitor	1 μ F	
C11	electrolytic capacitor	2200 μ F	
C12	multilayer ceramic chip capacitor	18 pF	[1]
L1	stripline	-	[2] (W \times L) 0.914 mm \times 10.160 mm
L2	stripline	-	[2] (W \times L) 0.914 mm \times 24.384 mm
L3	tapered stripline	-	[2] (W1 \times W2 \times L) 0.914 mm \times 19.812 mm \times 11.024 mm
L4	stripline	-	[2] (W \times L) 19.812 mm \times 21.438 mm
L5	stripline	-	[2] (W \times L) 0.914 mm \times 42.342 mm
L6	stripline	-	[2] (W \times L) 1.524 mm \times 42.418 mm
L7	stripline	-	[2] (W \times L) 17.221 mm \times 22.479 mm
L8	tapered stripline	-	[2] (W1 \times W2 \times L) 17.221 mm \times 0.914 mm \times 20.625 mm
L9	stripline	-	[2] (W \times L) 0.914 mm \times 19.126 mm
L10	stripline	-	[2] (W \times L) 0.914 mm \times 6.858 mm
R1, R2	SMD resistor	430 Ω	
R3	SMD resistor	300 Ω	
R4	potentiometer	200 Ω	
R5	SMD resistor	2 k Ω	
R6	SMD resistor	1.1 k Ω	
R7	SMD resistor	11 k Ω	
R8	SMD resistor	5.1 Ω	
R9	SMD resistor	5.1 k Ω	
R10	SMD resistor	910 Ω	
Q1	voltage regulator	-	78L08
Q2	transistor	-	2N2222
Q3	BLF4G10-160	-	

[1] American Technical Ceramics type 100B or capacitor of same quality.

[2] The striplines are on a double copper-clad Rogers 6006 Printed-Circuit Board (PCB) with $\epsilon_r = 6.15$ and thickness = 0.635 mm.

9. Package outline

Flanged LDMOST ceramic package; 2 mounting holes; 2 leads

SOT502A

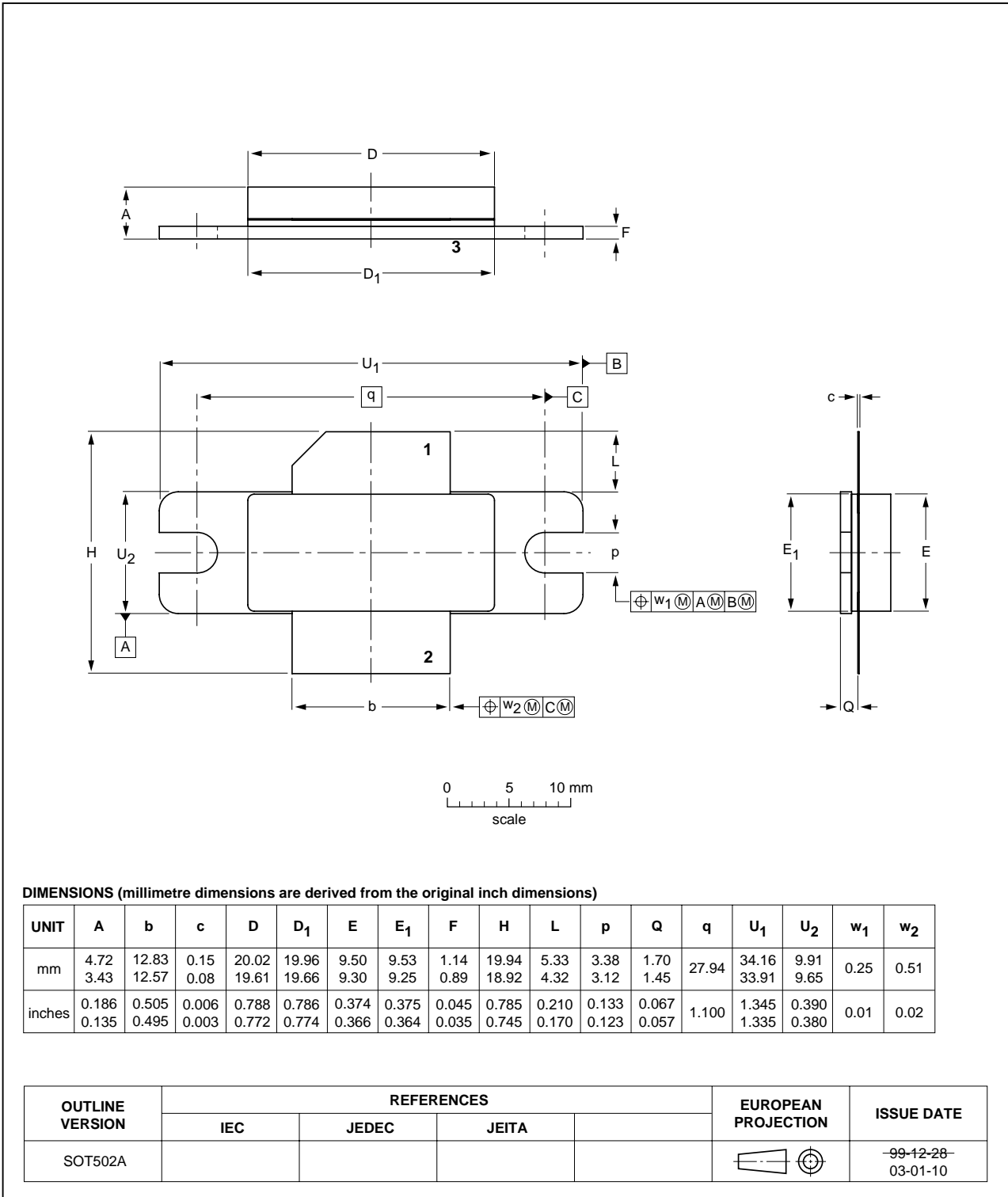

Fig 16. Package outline SOT502A

10. Abbreviations

Table 10. Abbreviations

Acronym	Description
CDMA	Code Division Multiple Access
CW	Continuous Waveform
EDGE	Enhanced Data GSM Environment
EVM	Error Vector Magnitude
GSM	Global System for Mobile communications
IS-95	CDMA Interim Standard 95
LDMOS	Laterally Diffused Metal Oxide Semiconductor
LDMOST	Laterally Diffused Metal-Oxide Semiconductor Transistor
PAR	Peak-to-Average power Ratio
RF	Radio Frequency
RMS	Root Mean Square
SMD	Surface-Mount Device
VSWR	Voltage Standing-Wave Ratio

11. Revision history

Table 11. Revision history

Document ID	Release date	Data sheet status	Change notice	Supersedes
BLF4G10-160_1	20070622	Product data sheet	-	-

12. Legal information

12.1 Data sheet status

Document status ^{[1][2]}	Product status ^[3]	Definition
Objective [short] data sheet	Development	This document contains data from the objective specification for product development.
Preliminary [short] data sheet	Qualification	This document contains data from the preliminary specification.
Product [short] data sheet	Production	This document contains the product specification.

[1] Please consult the most recently issued document before initiating or completing a design.

[2] The term 'short data sheet' is explained in section "Definitions".

[3] The product status of device(s) described in this document may have changed since this document was published and may differ in case of multiple devices. The latest product status information is available on the Internet at URL <http://www.nxp.com>.

12.2 Definitions

Draft — The document is a draft version only. The content is still under internal review and subject to formal approval, which may result in modifications or additions. NXP Semiconductors does not give any representations or warranties as to the accuracy or completeness of information included herein and shall have no liability for the consequences of use of such information.

Short data sheet — A short data sheet is an extract from a full data sheet with the same product type number(s) and title. A short data sheet is intended for quick reference only and should not be relied upon to contain detailed and full information. For detailed and full information see the relevant full data sheet, which is available on request via the local NXP Semiconductors sales office. In case of any inconsistency or conflict with the short data sheet, the full data sheet shall prevail.

12.3 Disclaimers

General — Information in this document is believed to be accurate and reliable. However, NXP Semiconductors does not give any representations or warranties, expressed or implied, as to the accuracy or completeness of such information and shall have no liability for the consequences of use of such information.

Right to make changes — NXP Semiconductors reserves the right to make changes to information published in this document, including without limitation specifications and product descriptions, at any time and without notice. This document supersedes and replaces all information supplied prior to the publication hereof.

Suitability for use — NXP Semiconductors products are not designed, authorized or warranted to be suitable for use in medical, military, aircraft, space or life support equipment, nor in applications where failure or

malfunction of a NXP Semiconductors product can reasonably be expected to result in personal injury, death or severe property or environmental damage. NXP Semiconductors accepts no liability for inclusion and/or use of NXP Semiconductors products in such equipment or applications and therefore such inclusion and/or use is at the customer's own risk.

Applications — Applications that are described herein for any of these products are for illustrative purposes only. NXP Semiconductors makes no representation or warranty that such applications will be suitable for the specified use without further testing or modification.

Limiting values — Stress above one or more limiting values (as defined in the Absolute Maximum Ratings System of IEC 60134) may cause permanent damage to the device. Limiting values are stress ratings only and operation of the device at these or any other conditions above those given in the Characteristics sections of this document is not implied. Exposure to limiting values for extended periods may affect device reliability.

Terms and conditions of sale — NXP Semiconductors products are sold subject to the general terms and conditions of commercial sale, as published at <http://www.nxp.com/profile/terms>, including those pertaining to warranty, intellectual property rights infringement and limitation of liability, unless explicitly otherwise agreed to in writing by NXP Semiconductors. In case of any inconsistency or conflict between information in this document and such terms and conditions, the latter will prevail.

No offer to sell or license — Nothing in this document may be interpreted or construed as an offer to sell products that is open for acceptance or the grant, conveyance or implication of any license under any copyrights, patents or other industrial or intellectual property rights.

12.4 Trademarks

Notice: All referenced brands, product names, service names and trademarks are the property of their respective owners.

13. Contact information

For additional information, please visit: <http://www.nxp.com>

For sales office addresses, send an email to: salesaddresses@nxp.com

14. Contents

1 Product profile 1

1.1 General description 1

1.2 Features 1

1.3 Applications 2

2 Pinning information 2

3 Ordering information 2

4 Limiting values 2

5 Thermal characteristics 2

6 Characteristics 3

7 Application information 3

7.1 Ruggedness in class-AB operation 3

8 Test information 7

9 Package outline 11

10 Abbreviations 12

11 Revision history 12

12 Legal information 13

12.1 Data sheet status 13

12.2 Definitions 13

12.3 Disclaimers 13

12.4 Trademarks 13

13 Contact information 13

14 Contents 14

Please be aware that important notices concerning this document and the product(s) described herein, have been included in section 'Legal information'.



© NXP B.V. 2007.

All rights reserved.

For more information, please visit: <http://www.nxp.com>

For sales office addresses, please send an email to: salesaddresses@nxp.com

Date of release: 22 June 2007

Document identifier: BLF4G10-160_1