

STRADA-2X2-SCL

Type II/III (long) beam for very wide pole to pole distances. Ideal for pedestrian paths and residential roads. EN13201 P-classes.

SPECIFICATION:

Dimensions	50.0 x 50.0 mm
Height	7.8 mm
Fastening	pin, screw
ROHS compliant	yes ⓘ

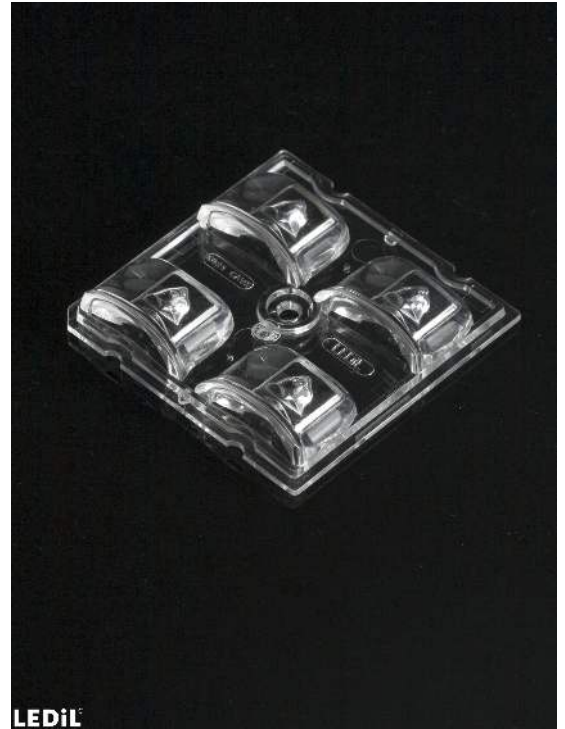

MATERIALS:

Component	Type	Material	Colour	Finish
STRADA-2X2-SCL	Multi-lens	PMMA	clear	





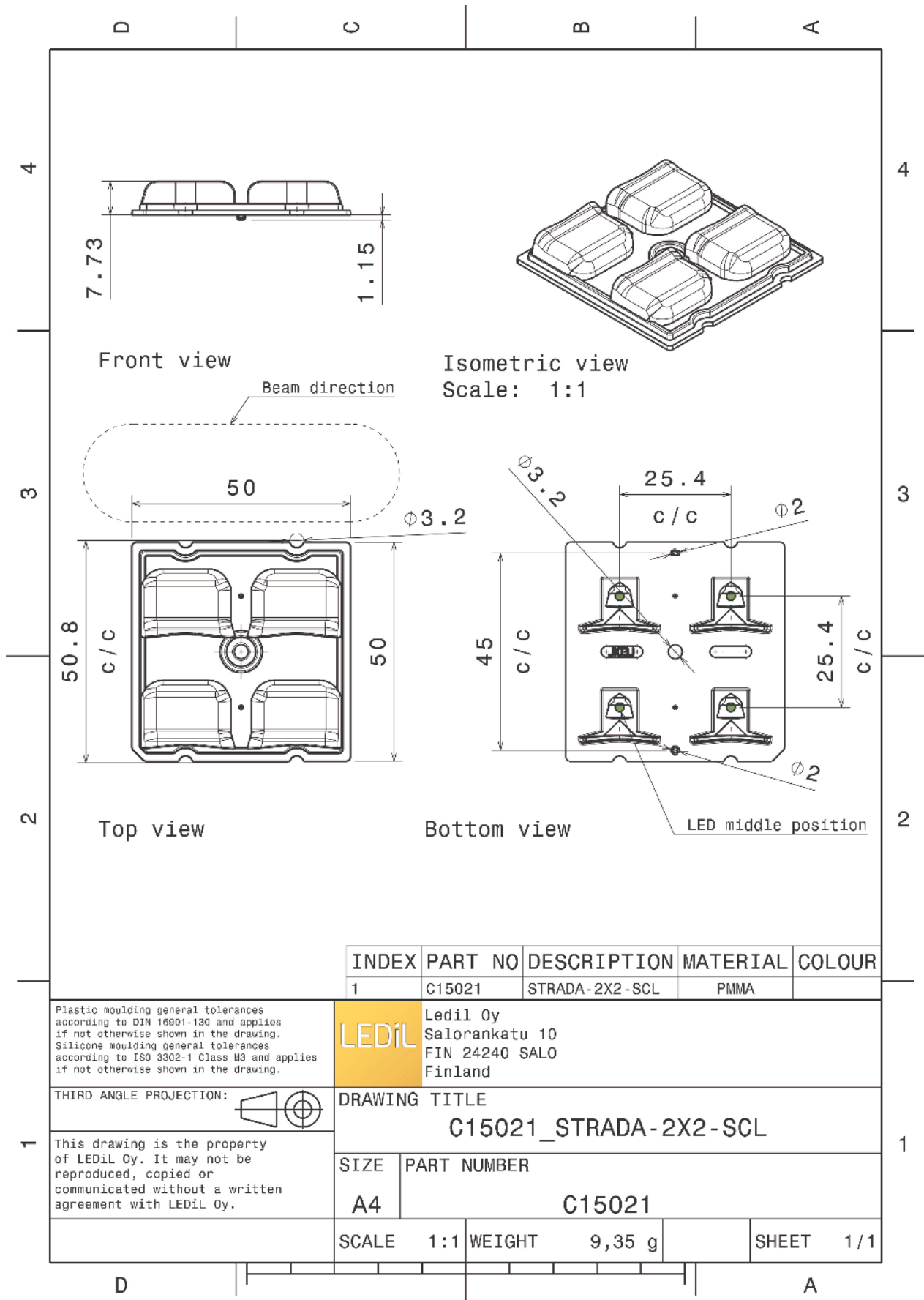



ORDERING INFORMATION:

Component	Qty in box	MOQ	MPQ	Box weight (kg)
C15021_STRADA-2X2-SCL » Box size: 480 x 280 x 300 mm	800	160	160	8.3

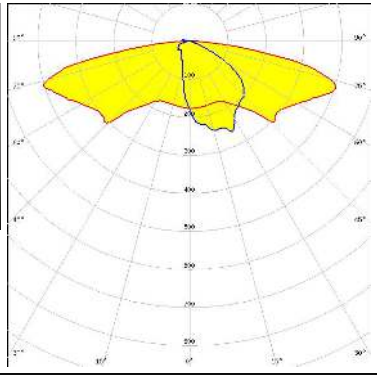

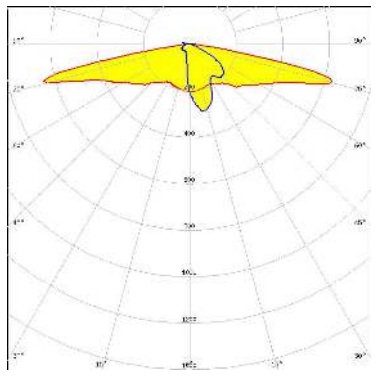

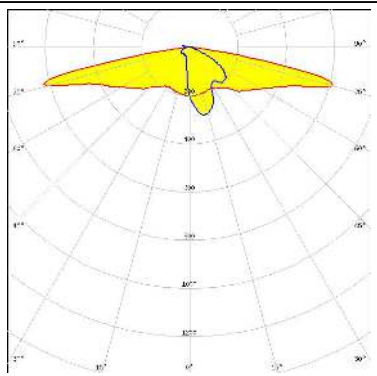

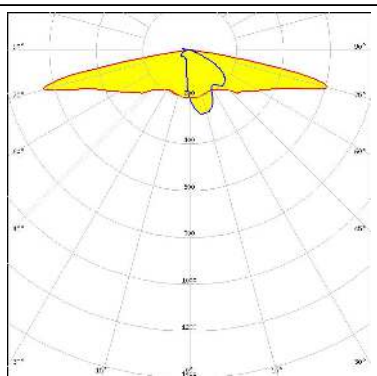

See also our general installation guide: www.ledil.com/installation_guide

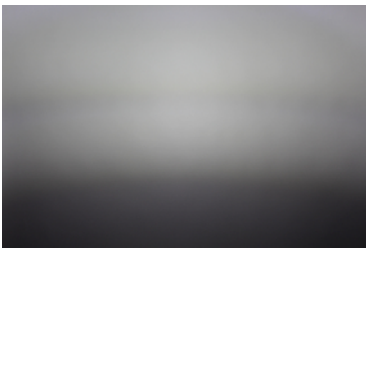
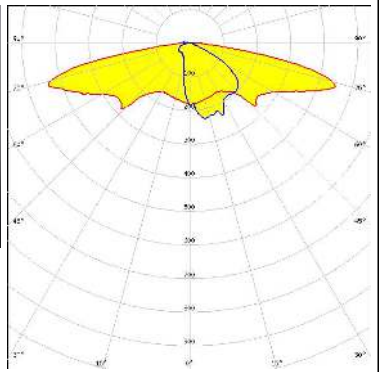
OPTICAL RESULTS (MEASURED):

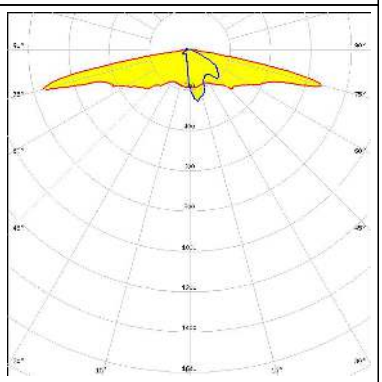
<p> LED Bridgelux SMD 5050</p> <p>FWHM / FWTM Asymmetric</p> <p>Efficiency 94 %</p> <p>Peak intensity 0.6 cd/lm</p> <p>LEDs/each optic 1</p> <p>Light colour White</p> <p>Required components:</p>		
<p> LED QUICK FLUX XTP 2x4 xxx LS G5</p> <p>FWHM / FWTM Asymmetric</p> <p>Efficiency 94 %</p> <p>Peak intensity 1 cd/lm</p> <p>LEDs/each optic 1</p> <p>Light colour White</p> <p>Required components:</p>		
<p> LED QUICK FLUX XTP 2x6 xxx LS G5</p> <p>FWHM / FWTM Asymmetric</p> <p>Efficiency 94 %</p> <p>Peak intensity 1 cd/lm</p> <p>LEDs/each optic 1</p> <p>Light colour White</p> <p>Required components:</p>		
<p> LED QUICK FLUX XTP 2x8 xxx LS G5</p> <p>FWHM / FWTM Asymmetric</p> <p>Efficiency 94 %</p> <p>Peak intensity 1 cd/lm</p> <p>LEDs/each optic 1</p> <p>Light colour White</p> <p>Required components:</p>		

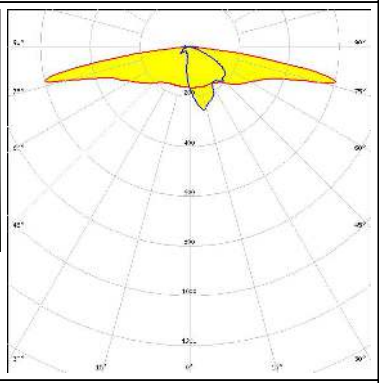
OPTICAL RESULTS (MEASURED):

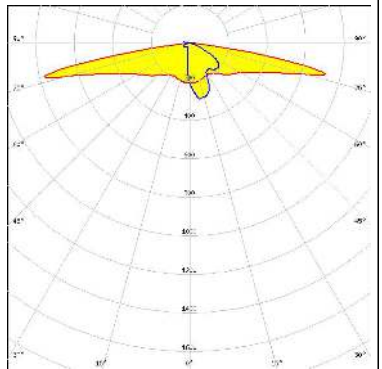
<p>CREE ⇄ LED</p> <p>LED: XD16 FWHM / FWTM: Asymmetric Efficiency: 94 % Peak intensity: 0.8 cd/lm LEDs/each optic: 4 Light colour: White Required components:</p>		
<p>CREE ⇄ LED</p> <p>LED: XD16 FWHM / FWTM: Asymmetric Efficiency: 94 % Peak intensity: 1.1 cd/lm LEDs/each optic: 1 Light colour: White Required components:</p>		
<p>CREE ⇄ LED</p> <p>LED: XM-L3 FWHM / FWTM: Asymmetric Efficiency: 94 % Peak intensity: 1.1 cd/lm LEDs/each optic: 1 Light colour: White Required components:</p>		
<p>CREE ⇄ LED</p> <p>LED: XP-G2 FWHM / FWTM: Asymmetric Efficiency: 94 % Peak intensity: 1.2 cd/lm LEDs/each optic: 1 Light colour: White Required components:</p>		

OPTICAL RESULTS (MEASURED):

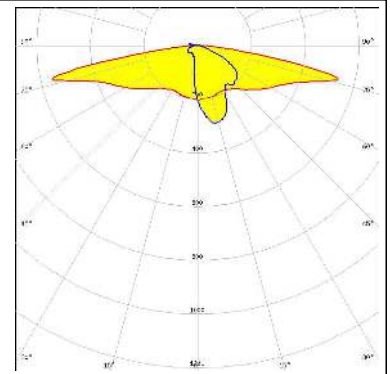
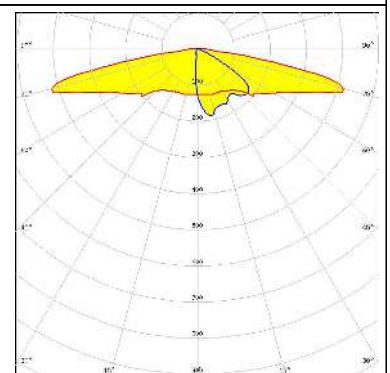
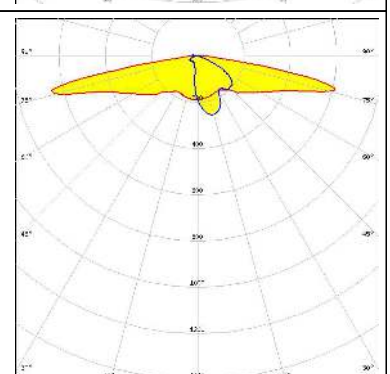
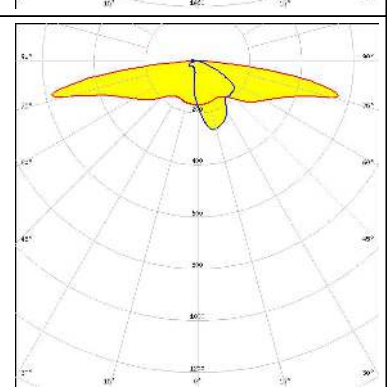
<p>CREE → LED</p> <p>LED XP-G2 HE FWHM / FWTM Asymmetric Efficiency 94 % Peak intensity 1 cd/lm LEDs/each optic 1 Light colour White Required components:</p>	
<p>CREE → LED</p> <p>LED XP-G3 FWHM / FWTM Asymmetric Efficiency 67 % Peak intensity 0.7 cd/lm LEDs/each optic 1 Light colour White Required components: C17677_STRADA-2X2-SHD-BLK</p>	
<p>CREE → LED</p> <p>LED XP-G3 FWHM / FWTM Asymmetric Efficiency 94 % Peak intensity 1 cd/lm LEDs/each optic 1 Light colour White Required components:</p>	
<p>CREE → LED</p> <p>LED XP-L HD FWHM / FWTM Asymmetric Efficiency 94 % Peak intensity 0.9 cd/lm LEDs/each optic 1 Light colour White Required components:</p>	

OPTICAL RESULTS (MEASURED):

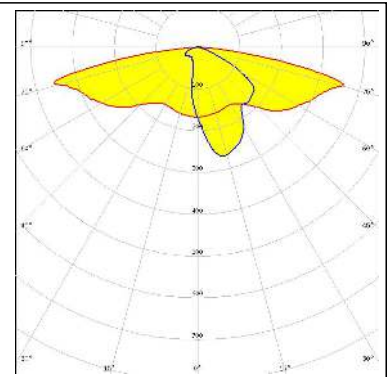
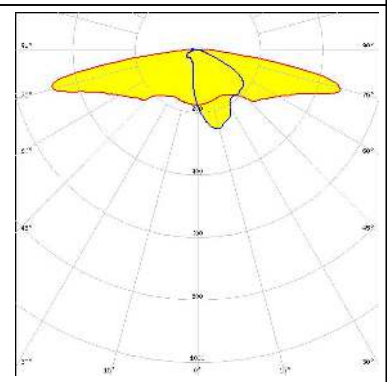
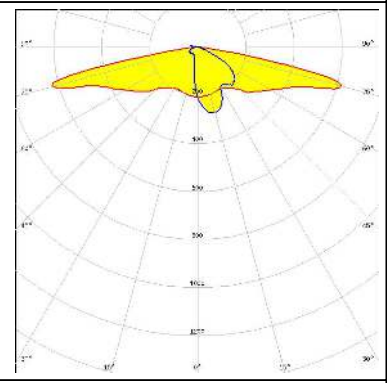
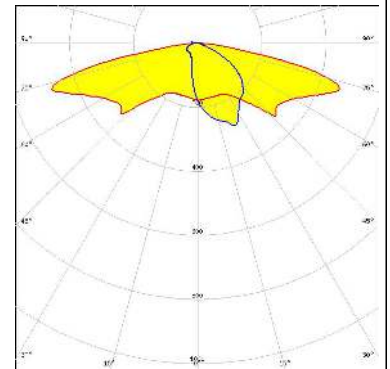
<p>CREE LED</p> <p>LED: XP-L HD FWHM / FWTM: Asymmetric Efficiency: 78 % Peak intensity: 0.6 cd/lm LEDs/each optic: 1 Light colour: White Required components: Protective plate, glass</p>	
<p>CREE LED</p> <p>LED: XP-L2 FWHM / FWTM: Asymmetric Efficiency: 94 % Peak intensity: 0.8 cd/lm LEDs/each optic: 1 Light colour: White Required components:</p>	
<p>ELECTRIO</p> <p>LED: EHP-2x8-3535 FWHM / FWTM: Asymmetric Efficiency: 96 % Peak intensity: 1 cd/lm LEDs/each optic: 1 Light colour: White Required components:</p>	
<p>ELECTRIO</p> <p>LED: EHP-2x8-5050 FWHM / FWTM: Asymmetric Efficiency: 96 % Peak intensity: 0.6 cd/lm LEDs/each optic: 1 Light colour: White Required components:</p>	

OPTICAL RESULTS (MEASURED):

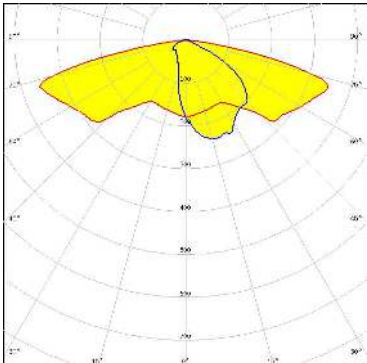
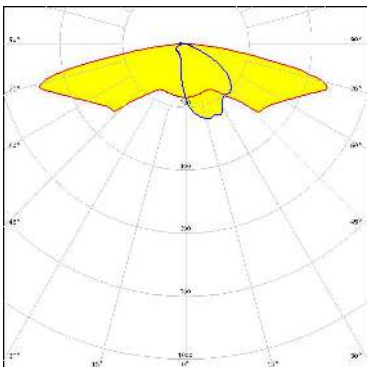
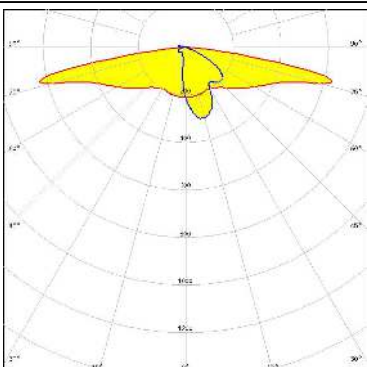
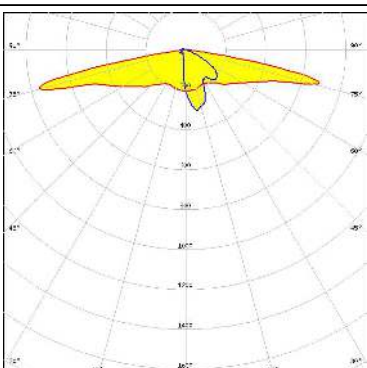
<p>LUMILEDS</p> <p>LED LUXEON 5050 Round LES</p> <p>FWHM / FWTM Asymmetric</p> <p>Efficiency 83 %</p> <p>Peak intensity 0.5 cd/lm</p> <p>LEDs/each optic 1</p> <p>Light colour White</p> <p>Required components:</p> <p>Protective plate, glass</p>	
<p>LUMILEDS</p> <p>LED LUXEON 5050 Round LES</p> <p>FWHM / FWTM Asymmetric</p> <p>Efficiency 94 %</p> <p>Peak intensity 0.7 cd/lm</p> <p>LEDs/each optic 1</p> <p>Light colour White</p> <p>Required components:</p>	
<p>LUMILEDS</p> <p>LED LUXEON HL2X</p> <p>FWHM / FWTM Asymmetric</p> <p>Efficiency 95 %</p> <p>Peak intensity 0.9 cd/lm</p> <p>LEDs/each optic 1</p> <p>Light colour White</p> <p>Required components:</p>	
<p>LUMILEDS</p> <p>LED LUXEON TX</p> <p>FWHM / FWTM Asymmetric</p> <p>Efficiency 94 %</p> <p>Peak intensity 1 cd/lm</p> <p>LEDs/each optic 1</p> <p>Light colour White</p> <p>Required components:</p>	

OPTICAL RESULTS (MEASURED):

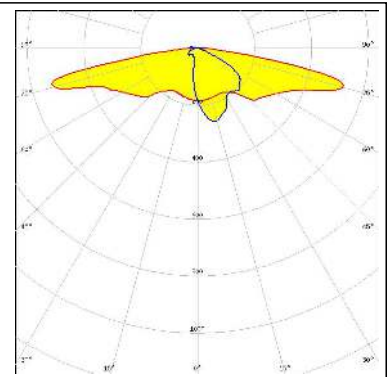
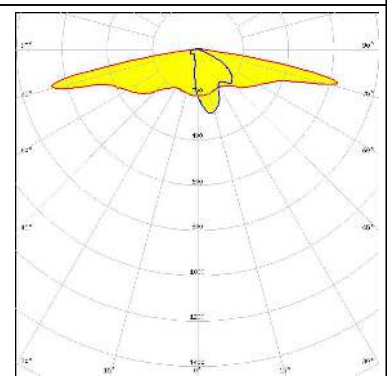
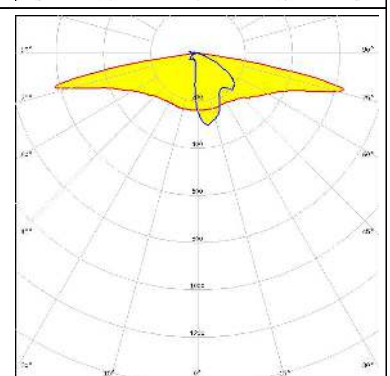
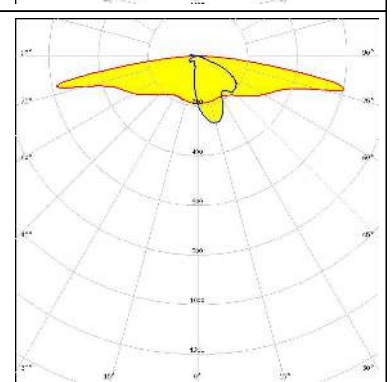
<p>LUMILEDS</p> <p>LED LUXEON V</p> <p>FWHM / FWTM Asymmetric</p> <p>Efficiency 94 %</p> <p>Peak intensity 0.8 cd/lm</p> <p>LEDs/each optic 1</p> <p>Light colour White</p> <p>Required components:</p>	
<p>LUMILEDS</p> <p>LED LUXEON V2</p> <p>FWHM / FWTM Asymmetric</p> <p>Efficiency 94 %</p> <p>Peak intensity 1 cd/lm</p> <p>LEDs/each optic 1</p> <p>Light colour White</p> <p>Required components:</p>	
<p>MST <i>Your solutions</i></p> <p>LED RecLED 122x50mm 1900lm 730 2x4 Opt G1</p> <p>FWHM / FWTM Asymmetric</p> <p>Efficiency 95 %</p> <p>Peak intensity 0.9 cd/lm</p> <p>LEDs/each optic 1</p> <p>Light colour White</p> <p>Required components:</p>	
<p>NICHIA</p> <p>LED NVSW319B</p> <p>FWHM / FWTM Asymmetric</p> <p>Efficiency 94 %</p> <p>Peak intensity 1.1 cd/lm</p> <p>LEDs/each optic 1</p> <p>Light colour White</p> <p>Required components:</p>	

OPTICAL RESULTS (MEASURED):

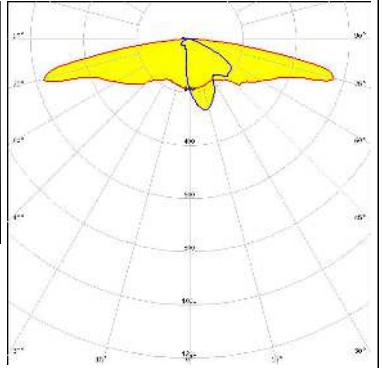
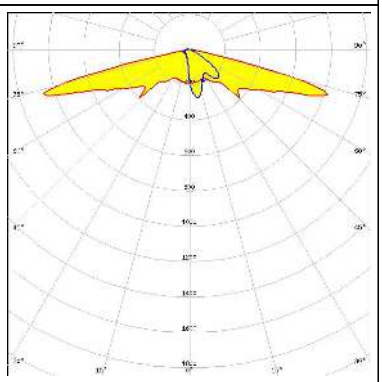
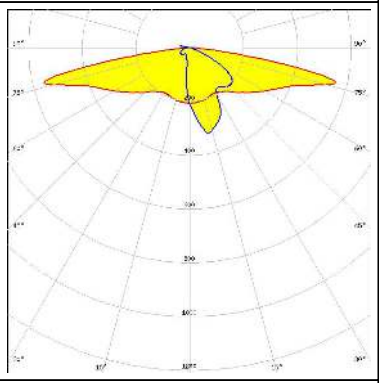
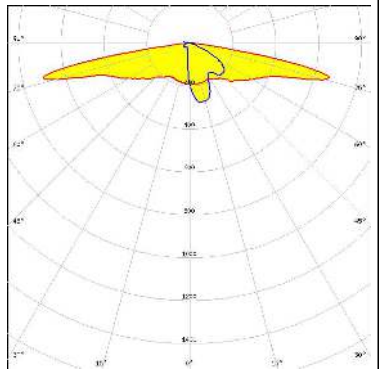
<p>NICHIA</p> <p>LED NVSW3x9A FWHM / FWTM Asymmetric Efficiency 94 % Peak intensity 0.9 cd/lm LEDs/each optic 1 Light colour White Required components:</p>		
<p>NICHIA</p> <p>LED NVSxE21A FWHM / FWTM Asymmetric Efficiency 94 % Peak intensity 0.4 cd/lm LEDs/each optic 1 Light colour White Required components:</p>		
<p>OSRAM</p> <p>LED PL-BRICK HP 3800 2x8 SSG FWHM / FWTM Asymmetric Efficiency 94 % Peak intensity 0.9 cd/lm LEDs/each optic 1 Light colour White Required components:</p>		
<p>OSRAM</p> <p>LED PrevaLED Brick HP 2x8 FWHM / FWTM Asymmetric Efficiency 94 % Peak intensity 1.1 cd/lm LEDs/each optic 1 Light colour White Required components:</p>		

OPTICAL RESULTS (MEASURED):

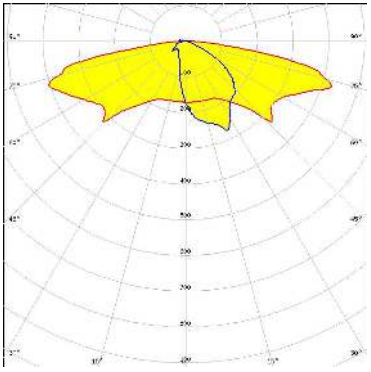
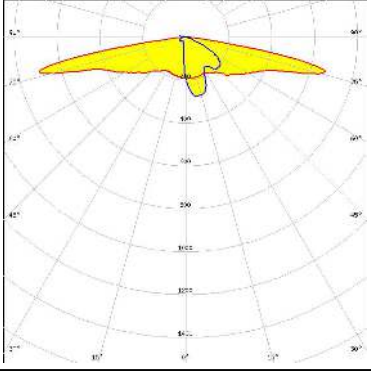
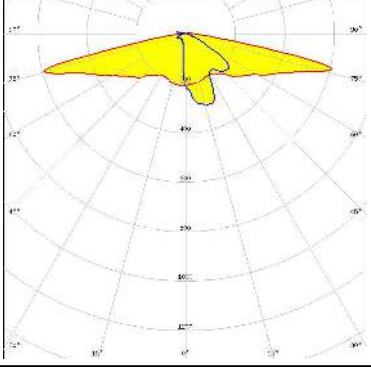
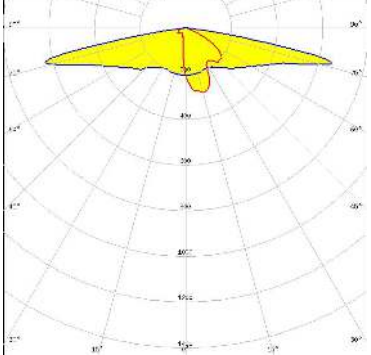
<p>OSRAM Opto Semiconductors</p> <p>LED Duris S8</p> <p>FWHM / FWTM Asymmetric</p> <p>Efficiency 95 %</p> <p>Peak intensity 0.6 cd/lm</p> <p>LEDs/each optic 1</p> <p>Light colour White</p> <p>Required components:</p>	
<p>OSRAM Opto Semiconductors</p> <p>LED OSLOM Square CSSRM2/CSSRM3</p> <p>FWHM / FWTM Asymmetric</p> <p>Efficiency 94 %</p> <p>Peak intensity 1.1 cd/lm</p> <p>LEDs/each optic 1</p> <p>Light colour White</p> <p>Required components:</p>	
<p>OSRAM Opto Semiconductors</p> <p>LED OSLOM Square PC</p> <p>FWHM / FWTM Asymmetric</p> <p>Efficiency 94 %</p> <p>Peak intensity 0.9 cd/lm</p> <p>LEDs/each optic 1</p> <p>Light colour White</p> <p>Required components:</p>	
<p>PHILIPS</p> <p>LED Fortimo FastFlex LED 2x8 DA G4</p> <p>FWHM / FWTM Asymmetric</p> <p>Efficiency 94 %</p> <p>Peak intensity 1 cd/lm</p> <p>LEDs/each optic 1</p> <p>Light colour White</p> <p>Required components:</p>	

OPTICAL RESULTS (MEASURED):

PHILIPS

LED Fortimo FastFlex LED 2x8 DA G4+
 FWHM / FWTM Asymmetric
 Efficiency 94 %
 Peak intensity 1 cd/lm
 LEDs/each optic 1
 Light colour White
 Required components:

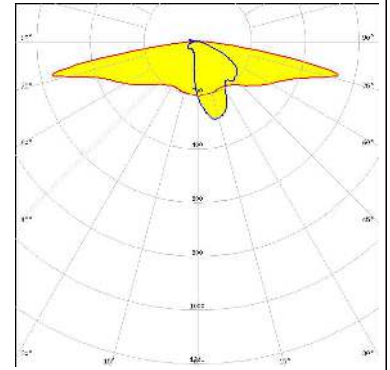

PHILIPS

LED Fortimo FastFlex LED 2x8 DA G5
 FWHM / FWTM Asymmetric
 Efficiency 95 %
 Peak intensity 1 cd/lm
 LEDs/each optic 1
 Light colour White
 Required components:

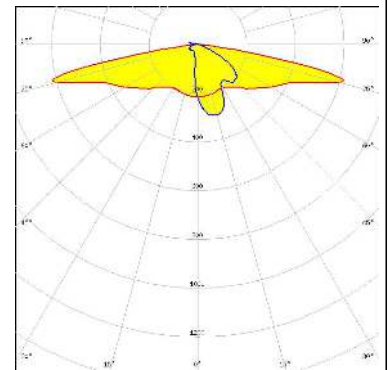

SAMSUNG

LED HiLOM RC12 Z (LH181B)
 FWHM / FWTM Asymmetric
 Efficiency 95 %
 Peak intensity 1 cd/lm
 LEDs/each optic 1
 Light colour White
 Required components:

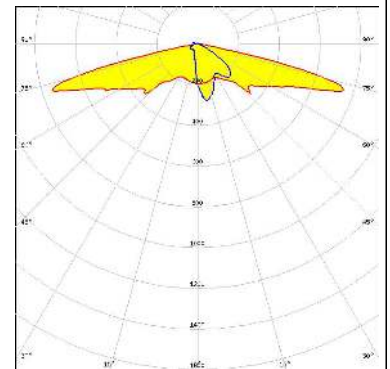

SAMSUNG

LED HiLOM RH12 Z (LH351C)
 FWHM / FWTM Asymmetric
 Efficiency 95 %
 Peak intensity 0.9 cd/lm
 LEDs/each optic 1
 Light colour White
 Required components:

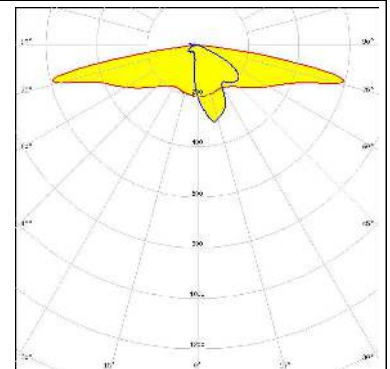

OPTICAL RESULTS (MEASURED):

SAMSUNG

LED HiLOM RH16 (LH351C)
 FWHM / FWTM Asymmetric
 Efficiency 94 %
 Peak intensity 0.9 cd/m
 LEDs/each optic 1
 Light colour White
 Required components:

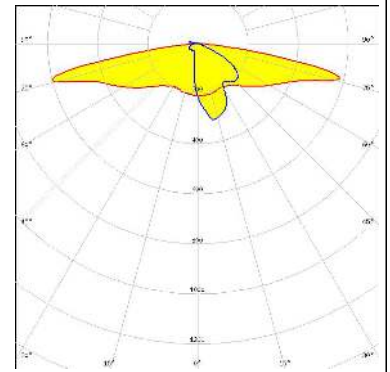

SAMSUNG

LED HiLOM RM12 Z (LH502C)
 FWHM / FWTM Asymmetric
 Efficiency 95 %
 Peak intensity 0.6 cd/m
 LEDs/each optic 1
 Light colour White
 Required components:

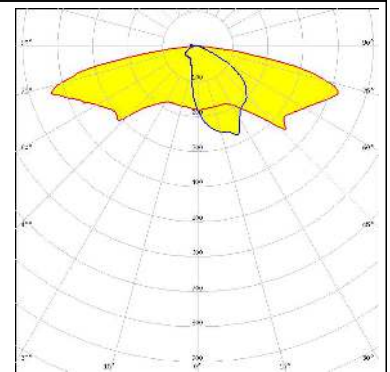

SAMSUNG

LED HiLOM RM16 Z (LH502C)
 FWHM / FWTM Asymmetric
 Efficiency 96 %
 Peak intensity 0.6 cd/m
 LEDs/each optic 1
 Light colour White
 Required components:

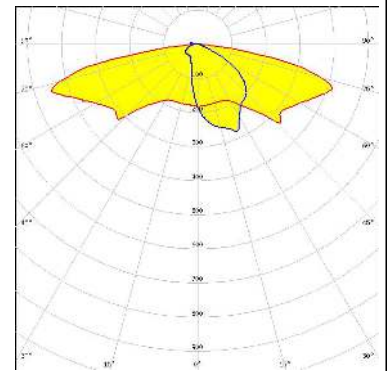

SAMSUNG

LED HiLOM RM8 Z (LH502C)
 FWHM / FWTM Asymmetric
 Efficiency 96 %
 Peak intensity 0.7 cd/m
 LEDs/each optic 1
 Light colour White
 Required components:

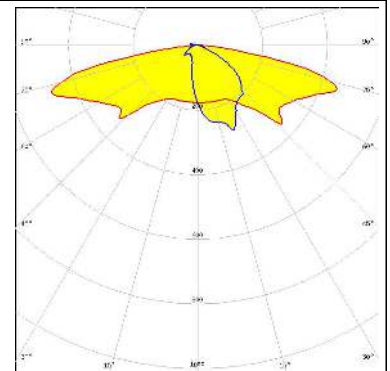

OPTICAL RESULTS (MEASURED):

SAMSUNG

LED LH351B
 FWHM / FWTM Asymmetric
 Efficiency 94 %
 Peak intensity 0.9 cd/lm
 LEDs/each optic 1
 Light colour White
 Required components:

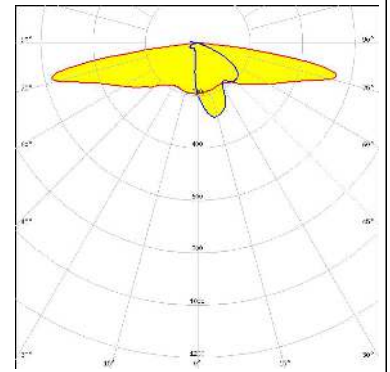

SAMSUNG

LED LH351C
 FWHM / FWTM Asymmetric
 Efficiency 94 %
 Peak intensity 0.9 cd/lm
 LEDs/each optic 1
 Light colour White
 Required components:

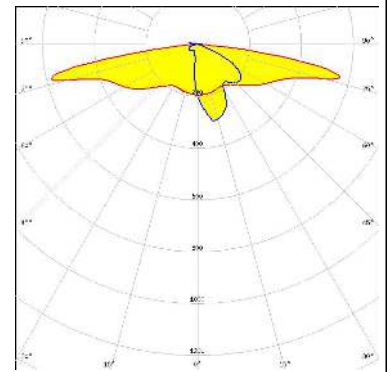

SAMSUNG

LED LH351D
 FWHM / FWTM Asymmetric
 Efficiency 93 %
 Peak intensity 0.7 cd/lm
 LEDs/each optic 1
 Light colour White
 Required components:

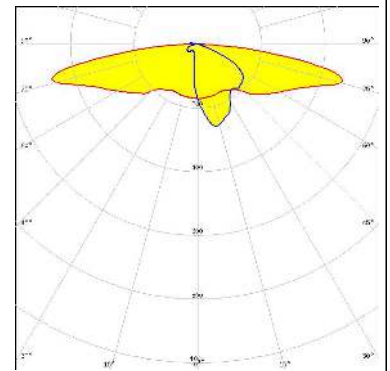

SAMSUNG

LED LH508A
 FWHM / FWTM Asymmetric
 Efficiency 94 %
 Peak intensity 0.7 cd/lm
 LEDs/each optic 1
 Light colour White
 Required components:

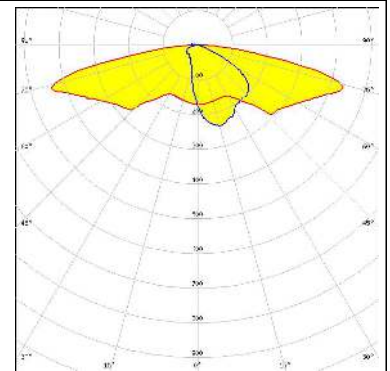

OPTICAL RESULTS (MEASURED):

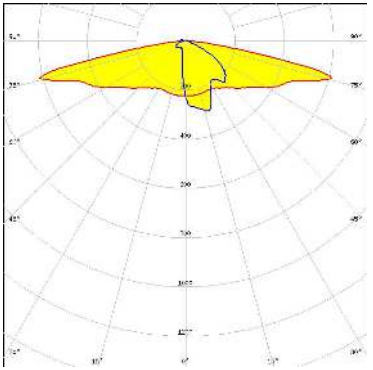
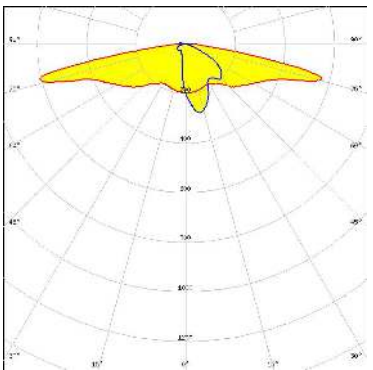
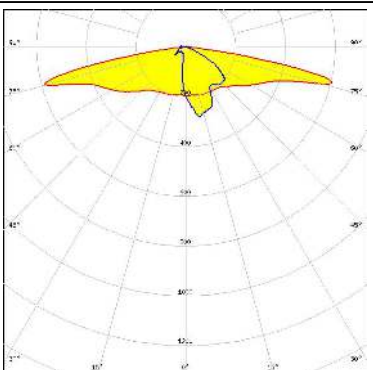
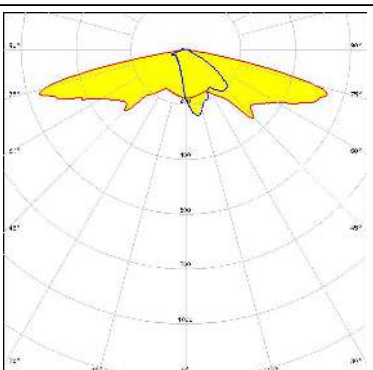
<p>SEITEC Elektronik GmbH</p> <p>LED LED-Pa-L15c2W11c2-xxx-C050-01 FWHM / FWTM Asymmetric Efficiency 96 % Peak intensity 1.1 cd/lm LEDs/each optic 1 Light colour White Required components:</p>	
<p>SEIOUL SEMICONDUCTOR</p> <p>LED Z5M3 FWHM / FWTM Asymmetric Efficiency 94 % Peak intensity 1 cd/lm LEDs/each optic 1 Light colour White Required components:</p>	
<p>SEIOUL SEMICONDUCTOR</p> <p>LED Z5M4 FWHM / FWTM Asymmetric Efficiency 95 % Peak intensity 1 cd/lm LEDs/each optic 1 Light colour White Required components:</p>	
<p>SEIOUL SEMICONDUCTOR</p> <p>LED Z8Y22 FWHM / FWTM Asymmetric Efficiency 94 % Peak intensity 0.9 cd/lm LEDs/each optic 1 Light colour White Required components:</p>	

OPTICAL RESULTS (MEASURED):

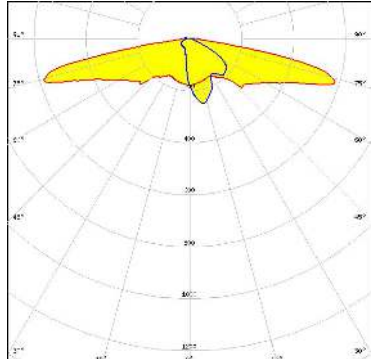
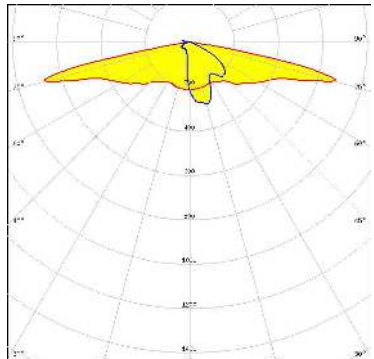
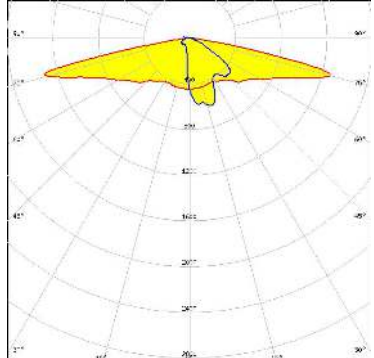
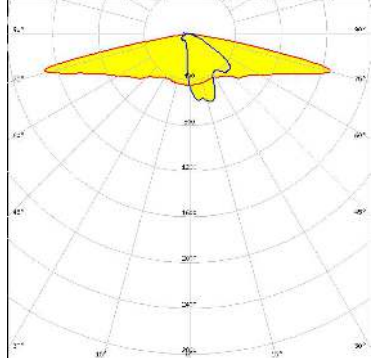
<p> SECHIL SEMICONDUCTOR</p> <p>LED Z8Y22P FWHM / FWTM Asymmetric Efficiency 94 % Peak intensity 1 cd/lm LEDs/each optic 1 Light colour White Required components:</p>	
<p>TRIDONIC</p> <p>LED RLE 2x8 4000lm HP EXC2 OTD FWHM / FWTM Asymmetric Efficiency 94 % Peak intensity 1 cd/lm LEDs/each optic 1 Light colour White Required components:</p>	
<p>TRIDONIC</p> <p>LED RLE G1 49x121mm 2000lm xxx EXC OTD FWHM / FWTM Asymmetric Efficiency 94 % Peak intensity 0.9 cd/lm LEDs/each optic 1 Light colour White Required components:</p>	
<p>TRIDONIC</p> <p>LED RLE G1 49x133mm 2000lm xxx EXC OTD FWHM / FWTM Asymmetric Efficiency 94 % Peak intensity 0.9 cd/lm LEDs/each optic 1 Light colour White Required components:</p>	

OPTICAL RESULTS (MEASURED):

TRIDONIC

LED RLE G1 49x223mm 4000lm xxx EXC OTD
FWHM / FWTM Asymmetric
Efficiency 94 %
Peak intensity 0.9 cd/lm
LEDs/each optic 1
Light colour White
Required components:

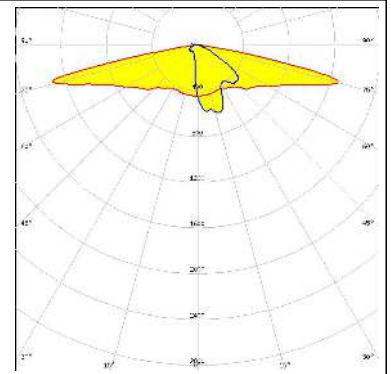

TRIDONIC



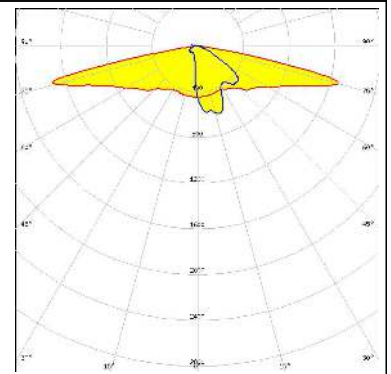

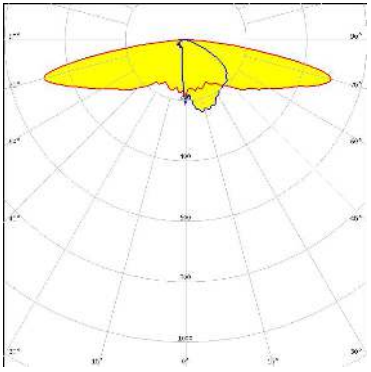
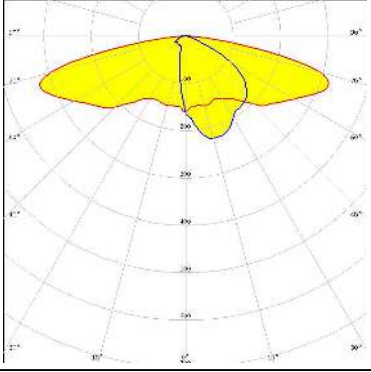
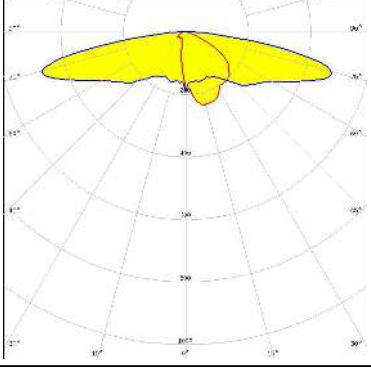
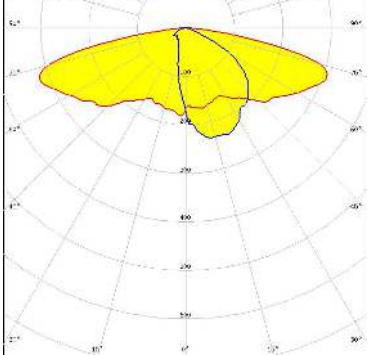

LED RLE G1 49x245mm 4000lm xxx EXC OTD
FWHM / FWTM Asymmetric
Efficiency 94 %
Peak intensity 0.9 cd/lm
LEDs/each optic 1
Light colour White
Required components:

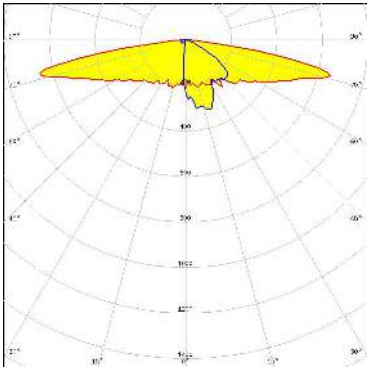

OPTICAL RESULTS (SIMULATED):

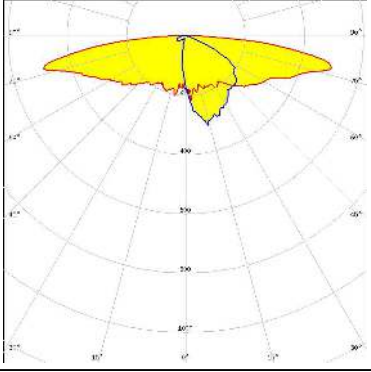
<p>CREE LED</p> <p>LED: J Series 5050 Round LES FWHM / FWTM: Asymmetric Efficiency: 92 % Peak intensity: 0.7 cd/lm LEDs/each optic: 1 Light colour: White Required components:</p>	
<p>CREE LED</p> <p>LED: J Series 5050 Round LES FWHM / FWTM: Asymmetric Efficiency: 74 % Peak intensity: 0.4 cd/lm LEDs/each optic: 1 Light colour: White Required components:</p> <p>Protective plate, glass</p>	
<p>CREE LED</p> <p>LED: J Series 5050 Round LES FWHM / FWTM: Asymmetric Efficiency: 92 % Peak intensity: 0.7 cd/lm LEDs/each optic: 1 Light colour: White Required components:</p>	
<p>CREE LED</p> <p>LED: J Series 5050B 6V K Class FWHM / FWTM: Asymmetric Efficiency: 76 % Peak intensity: 0.4 cd/lm LEDs/each optic: 1 Light colour: White Required components:</p> <p>Protective plate, glass</p>	

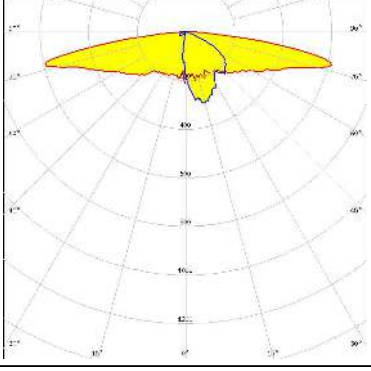
OPTICAL RESULTS (SIMULATED):

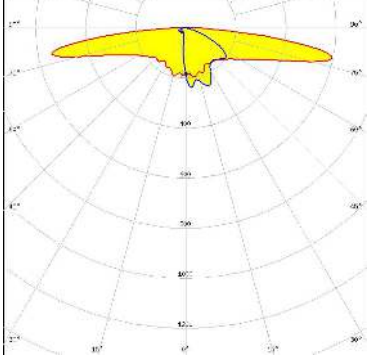
	<p>LED XB-H FWHM / FWTM Asymmetric Efficiency % LEDs/each optic 1 Light colour White Required components:</p>	
	<p>LED XHP35 HD FWHM / FWTM Asymmetric Efficiency % LEDs/each optic 1 Light colour White Required components:</p>	
	<p>LED XM-L2 FWHM / FWTM Asymmetric Efficiency % LEDs/each optic 1 Light colour White Required components:</p>	
	<p>LED XP-E2 FWHM / FWTM Asymmetric Efficiency 91 % Peak intensity 0.7 cd/lm LEDs/each optic 1 Light colour White Required components:</p>	

OPTICAL RESULTS (SIMULATED):

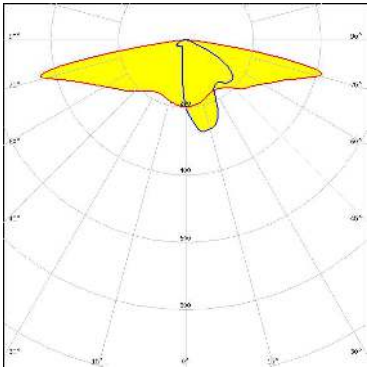
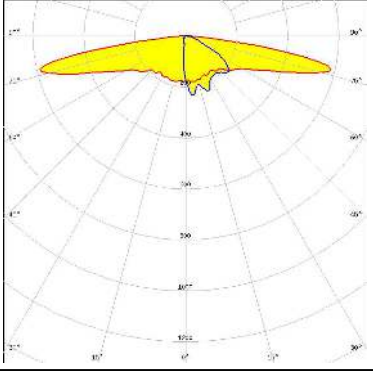
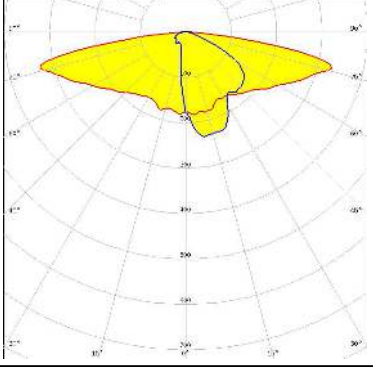
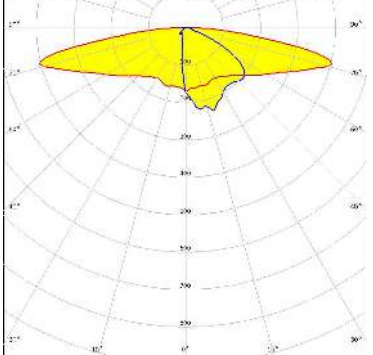
<p>CREE LED</p> <p>LED: XP-G2 FWHM / FWTM: Asymmetric Efficiency: 75 % Peak intensity: 0.6 cd/lm LEDs/each optic: 1 Light colour: White Required components: Protective plate, glass</p>	
<p>CREE LED</p> <p>LED: XP-G2 FWHM / FWTM: Asymmetric Efficiency: 81 % Peak intensity: 0.8 cd/lm LEDs/each optic: 1 Light colour: White Required components: C17580_STRADA-2X2-SHD-WHT</p>	
<p>CREE LED</p> <p>LED: XP-G3 FWHM / FWTM: Asymmetric Efficiency: 72 % Peak intensity: 0.4 cd/lm LEDs/each optic: 1 Light colour: White Required components: Protective plate, glass</p>	
<p>CREE LED</p> <p>LED: XP-G3 FWHM / FWTM: Asymmetric Efficiency: 79 % Peak intensity: 0.6 cd/lm LEDs/each optic: 1 Light colour: White Required components: C17580_STRADA-2X2-SHD-WHT</p>	

OPTICAL RESULTS (SIMULATED):

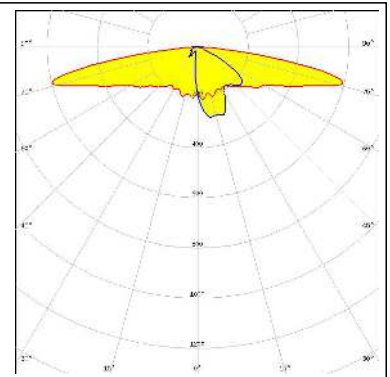
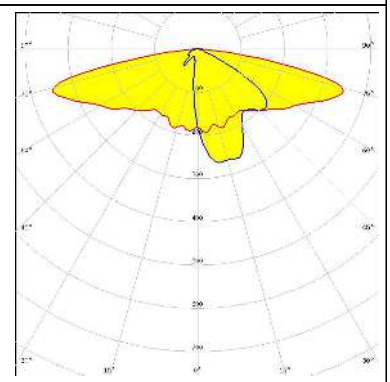
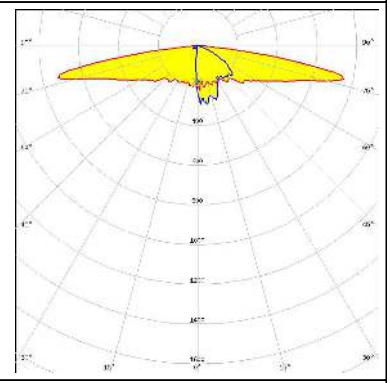
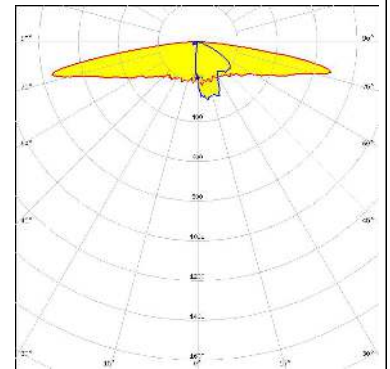
<p>CREE → LED</p> <p>LED: XP-G4 FWHM / FWTM: Asymmetric Efficiency: 93 % Peak intensity: 0.7 cd/lm LEDs/each optic: 1 Light colour: White Required components:</p>	
<p>CREE → LED</p> <p>LED: XP-G4 FWHM / FWTM: Asymmetric Efficiency: 76 % Peak intensity: 0.5 cd/lm LEDs/each optic: 1 Light colour: White Required components:</p> <p style="background-color: #ADD8E6; padding: 2px; display: inline-block;">Protective plate, glass</p>	
<p>CREE → LED</p> <p>LED: XP-L HI FWHM / FWTM: Asymmetric Efficiency: % LEDs/each optic: 1 Light colour: White Required components:</p>	
<p>CREE → LED</p> <p>LED: XT-E FWHM / FWTM: Asymmetric Efficiency: % LEDs/each optic: 1 Light colour: White Required components:</p>	

OPTICAL RESULTS (SIMULATED):

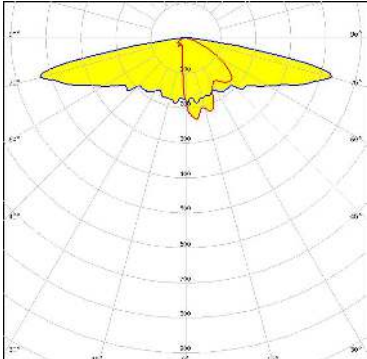
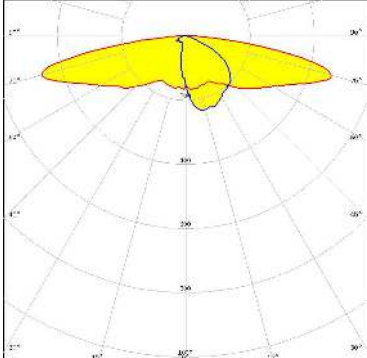
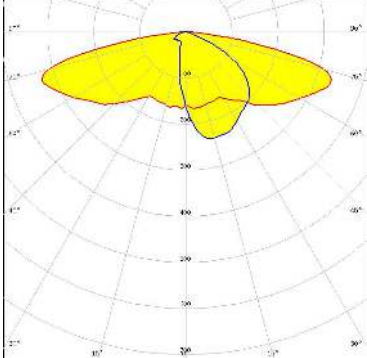
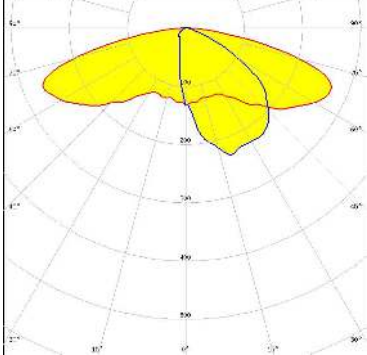
<p>CREE LED</p> <p>LED: XT-E FWHM / FWTM: Asymmetric Efficiency: 73 % Peak intensity: 0.5 cd/lm LEDs/each optic: 1 Light colour: White Required components: Protective plate, glass</p>	
<p>LUMILEDS</p> <p>LED: LUXEON 5050 Square LES FWHM / FWTM: Asymmetric Efficiency: 92 % Peak intensity: 0.6 cd/lm LEDs/each optic: 1 Light colour: White Required components:</p>	
<p>LUMILEDS</p> <p>LED: LUXEON 5050 Square LES FWHM / FWTM: Asymmetric Efficiency: 79 % Peak intensity: 0.4 cd/lm LEDs/each optic: 1 Light colour: White Required components: Protective plate, glass</p>	
<p>LUMILEDS</p> <p>LED: LUXEON 5050 Square LES FWHM / FWTM: Asymmetric Efficiency: 67 % Peak intensity: 0.4 cd/lm LEDs/each optic: 1 Light colour: White Required components: C17580_STRADA-2X2-SHD-WHT Protective plate, glass</p>	

OPTICAL RESULTS (SIMULATED):

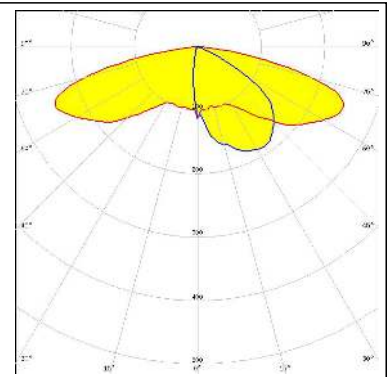
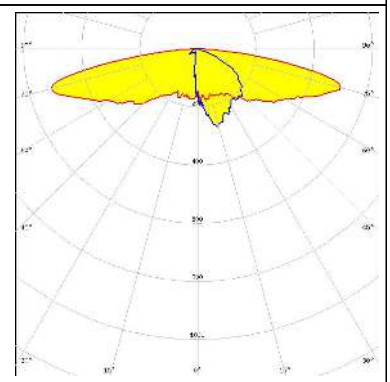
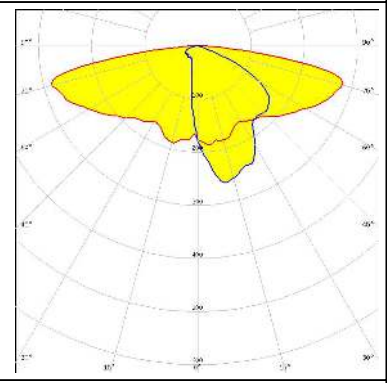
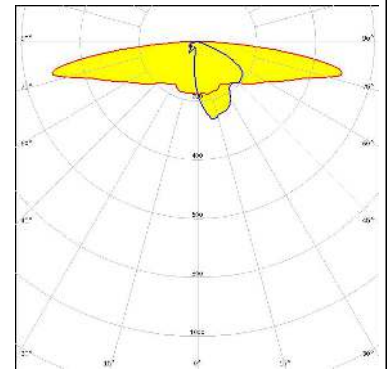
<p>LUMILEDS</p> <p>LED: LUXEON 5050 Square LES</p> <p>FWHM / FWTM: Asymmetric</p> <p>Efficiency: 56 %</p> <p>Peak intensity: 0.4 cd/lm</p> <p>LEDs/each optic: 1</p> <p>Light colour: White</p> <p>Required components: C17677_STRADA-2X2-SHD-BLK</p> <p>Protective plate, glass</p>	
<p>LUMILEDS</p> <p>LED: LUXEON 5258</p> <p>FWHM / FWTM: Asymmetric</p> <p>Efficiency: %</p> <p>LEDs/each optic: 1</p> <p>Light colour: White</p> <p>Required components:</p>	
<p>LUMILEDS</p> <p>LED: LUXEON HL2X</p> <p>FWHM / FWTM: Asymmetric</p> <p>Efficiency: 73 %</p> <p>Peak intensity: 0.4 cd/lm</p> <p>LEDs/each optic: 1</p> <p>Light colour: White</p> <p>Required components:</p> <p>Protective plate, glass</p>	
<p>LUMILEDS</p> <p>LED: LUXEON HL2X-D</p> <p>FWHM / FWTM: Asymmetric</p> <p>Efficiency: 92 %</p> <p>Peak intensity: 0.7 cd/lm</p> <p>LEDs/each optic: 1</p> <p>Light colour: White</p> <p>Required components:</p>	

OPTICAL RESULTS (SIMULATED):

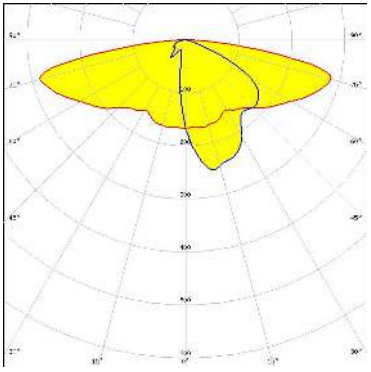
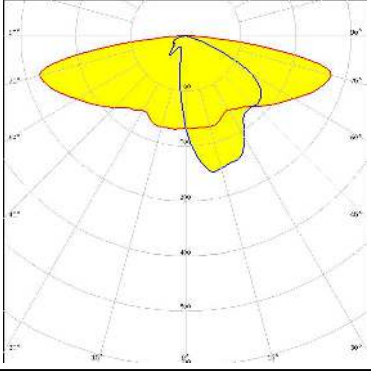
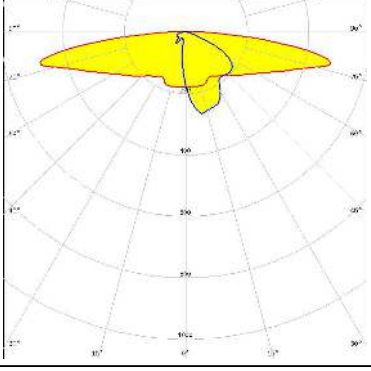
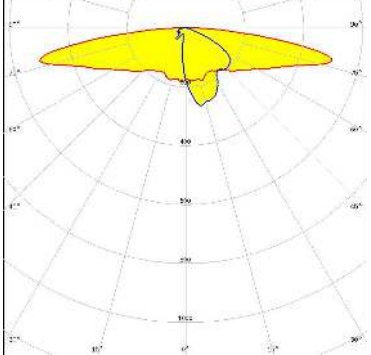
<p>LUMILEDS</p> <p>LED: LUXEON HL2X-D</p> <p>FWHM / FWTM: Asymmetric</p> <p>Efficiency: 73 %</p> <p>Peak intensity: 0.4 cd/lm</p> <p>LEDs/each optic: 1</p> <p>Light colour: White</p> <p>Required components:</p> <p>Protective plate, glass</p>	
<p>LUMILEDS</p> <p>LED: LUXEON HL2X-P</p> <p>FWHM / FWTM: Asymmetric</p> <p>Efficiency: 72 %</p> <p>Peak intensity: 0.4 cd/lm</p> <p>LEDs/each optic: 1</p> <p>Light colour: White</p> <p>Required components:</p> <p>Protective plate, glass</p>	
<p>LUMILEDS</p> <p>LED: LUXEON HL2X-P</p> <p>FWHM / FWTM: Asymmetric</p> <p>Efficiency: 92 %</p> <p>Peak intensity: 0.6 cd/lm</p> <p>LEDs/each optic: 1</p> <p>Light colour: White</p> <p>Required components:</p>	
<p>LUMILEDS</p> <p>LED: LUXEON XR-HL2X (L2H2-xxxxxxxMLU010)</p> <p>FWHM / FWTM: Asymmetric</p> <p>Efficiency: 92 %</p> <p>Peak intensity: 0.7 cd/lm</p> <p>LEDs/each optic: 1</p> <p>Light colour: White</p> <p>Required components:</p>	

OPTICAL RESULTS (SIMULATED):

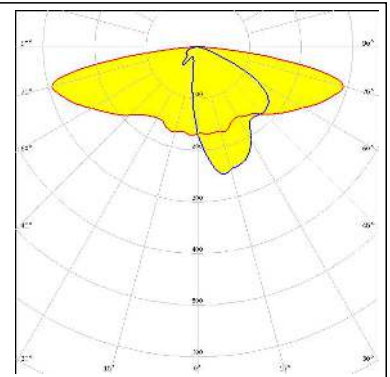
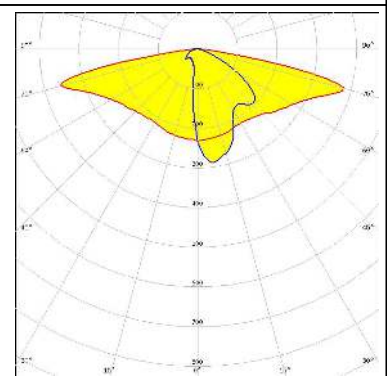
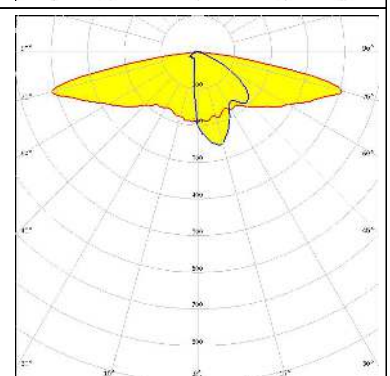
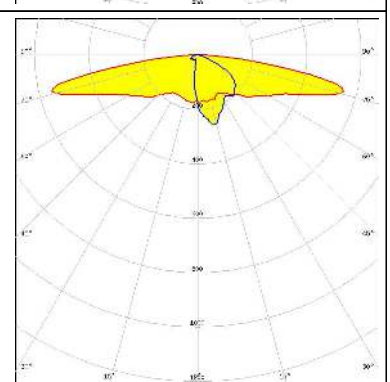
<p>LUMILEDS</p> <p>LED LUXEON XR-HL2X (L2H2-xxxxxxxMLU010)</p> <p>FWHM / FWTM Asymmetric</p> <p>Efficiency 73 %</p> <p>Peak intensity 0.4 cd/lm</p> <p>LEDs/each optic 1</p> <p>Light colour White</p> <p>Required components:</p> <p>Protective plate, glass</p>	
<p>MST <i>Your solutions</i></p> <p>LED RecLED 122x50mm 1900lm 730 2x4 Opt G1</p> <p>FWHM / FWTM Asymmetric</p> <p>Efficiency 77 %</p> <p>Peak intensity 0.5 cd/lm</p> <p>LEDs/each optic 1</p> <p>Light colour White</p> <p>Required components:</p> <p>Protective plate, glass</p>	
<p>NICHIA</p> <p>LED NF2x757G</p> <p>FWHM / FWTM Asymmetric</p> <p>Efficiency 75 %</p> <p>Peak intensity 0.5 cd/lm</p> <p>LEDs/each optic 1</p> <p>Light colour White</p> <p>Required components:</p> <p>Protective plate, glass</p>	
<p>NICHIA</p> <p>LED NV4WB35AM</p> <p>FWHM / FWTM Asymmetric</p> <p>Efficiency 92 %</p> <p>Peak intensity 0.8 cd/lm</p> <p>LEDs/each optic 1</p> <p>Light colour White</p> <p>Required components:</p>	

OPTICAL RESULTS (SIMULATED):

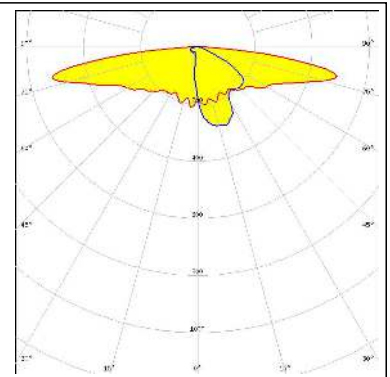
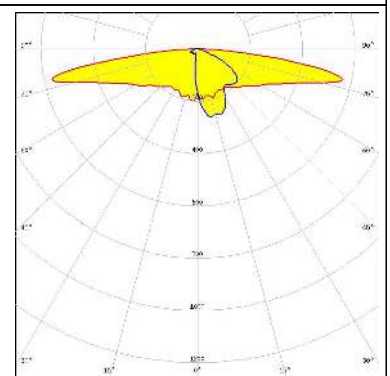
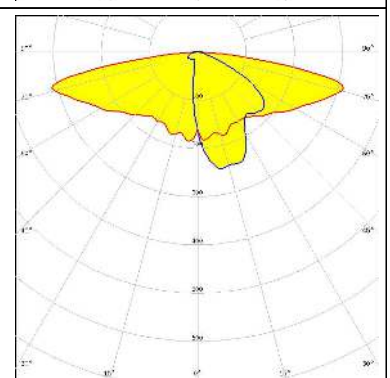
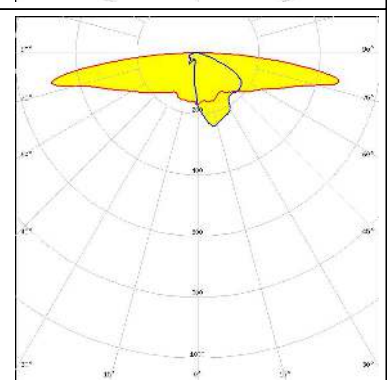
<p>NICHIA</p> <p>LED: NVSW219D FWHM / FWTM: Asymmetric Efficiency: 91 % Peak intensity: 0.7 cd/lm LEDs/each optic: 1 Light colour: White Required components:</p>	
<p>NICHIA</p> <p>LED: NVSW219F FWHM / FWTM: Asymmetric Efficiency: 90 % Peak intensity: 0.7 cd/lm LEDs/each optic: 1 Light colour: White Required components:</p>	
<p>NICHIA</p> <p>LED: NVSW219F FWHM / FWTM: Asymmetric Efficiency: 71 % Peak intensity: 0.4 cd/lm LEDs/each optic: 1 Light colour: White Required components:</p> <p style="background-color: #ADD8E6; padding: 2px;">Protective plate, glass</p>	
<p>NICHIA</p> <p>LED: NVSW519A FWHM / FWTM: Asymmetric Efficiency: 89 % Peak intensity: 0.7 cd/lm LEDs/each optic: 1 Light colour: White Required components:</p>	

OPTICAL RESULTS (SIMULATED):

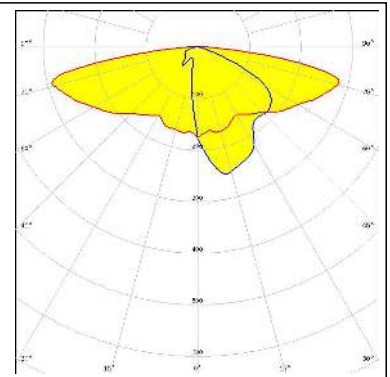
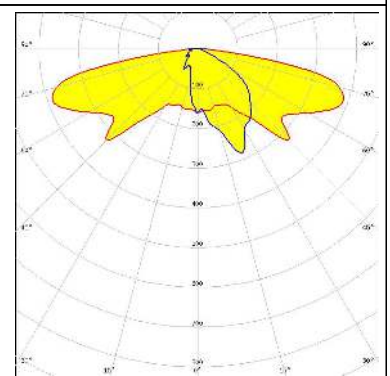
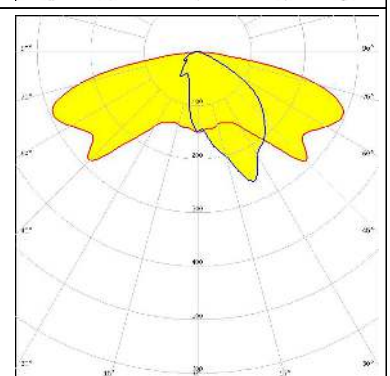
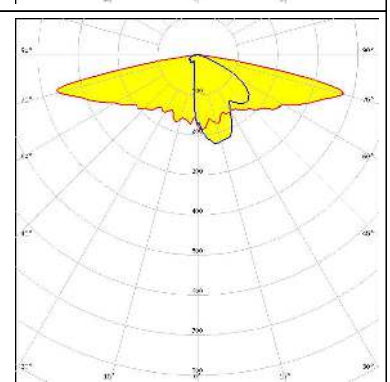
<p>NICHIA</p> <p>LED: NVSW519A FWHM / FWTM: Asymmetric Efficiency: 76 % Peak intensity: 0.4 cd/lm LEDs/each optic: 1 Light colour: White Required components:</p> <p>Protective plate, glass</p>	
<p>NICHIA</p> <p>LED: NVSxE21A FWHM / FWTM: Asymmetric Efficiency: 93 % Peak intensity: 0.5 cd/lm LEDs/each optic: 4 Light colour: White Required components:</p>	
<p>NICHIA</p> <p>LED: NVSxE21A FWHM / FWTM: Asymmetric Efficiency: 77 % Peak intensity: 0.4 cd/lm LEDs/each optic: 4 Light colour: White Required components:</p> <p>Protective plate, glass</p>	
<p>NICHIA</p> <p>LED: NVSxx19B/NVSxx19C FWHM / FWTM: Asymmetric Efficiency: 69 % Peak intensity: 0.5 cd/lm LEDs/each optic: 1 Light colour: White Required components:</p> <p>Protective plate, glass</p>	

OPTICAL RESULTS (SIMULATED):

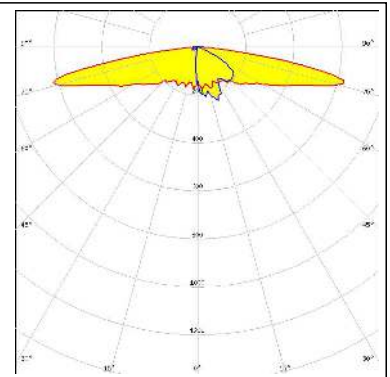
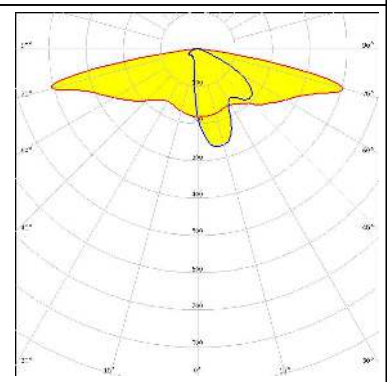
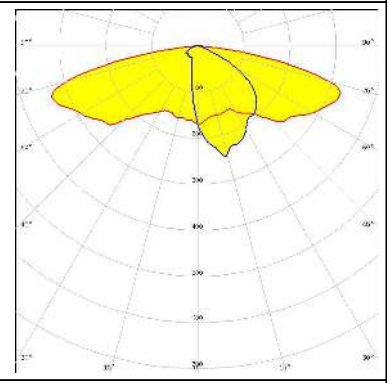
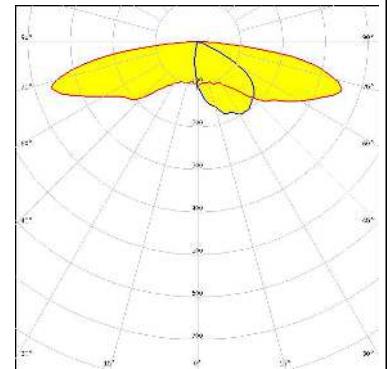
<p>NICHIA</p> <p>LED: NVSxx19B/NVSxx19C FWHM / FWTM: Asymmetric Efficiency: 87 % Peak intensity: 0.8 cd/lm LEDs/each optic: 1 Light colour: White Required components:</p>	
<p>OSRAM</p> <p>LED: PrevaLED Brick HP 2x8 FWHM / FWTM: Asymmetric Efficiency: 75 % Peak intensity: 0.5 cd/lm LEDs/each optic: 1 Light colour: White Required components:</p> <p>Protective plate, glass</p>	
<p>OSRAM <small>Opto Semiconductors</small></p> <p>LED: Duris S8 FWHM / FWTM: Asymmetric Efficiency: 76 % Peak intensity: 0.4 cd/lm LEDs/each optic: 1 Light colour: White Required components:</p> <p>Protective plate, glass</p>	
<p>OSRAM <small>Opto Semiconductors</small></p> <p>LED: Duris S8 FWHM / FWTM: Asymmetric Efficiency: 70 % Peak intensity: 0.5 cd/lm LEDs/each optic: 1 Light colour: White Required components:</p> <p>C17677_STRADA-2X2-SHD-BLK</p>	

OPTICAL RESULTS (SIMULATED):

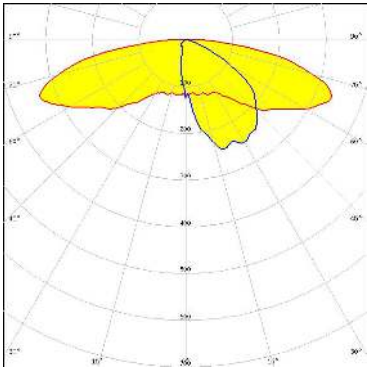
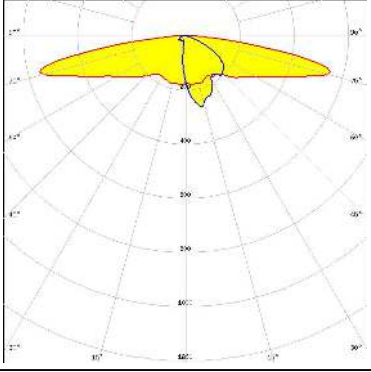
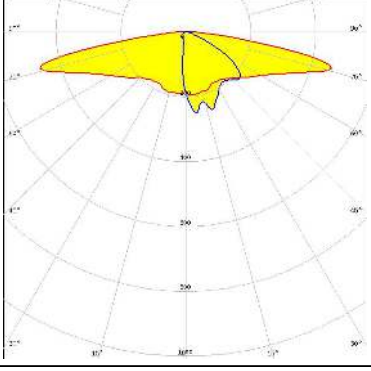
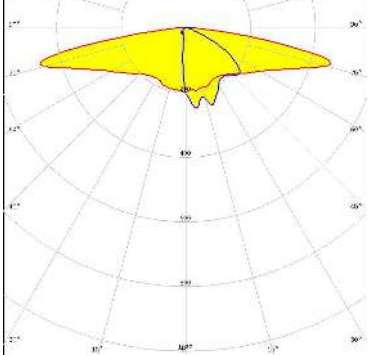
<p>OSRAM Opto Semiconductors</p> <p>LED Duris S8</p> <p>FWHM / FWTM Asymmetric</p> <p>Efficiency 79 %</p> <p>Peak intensity 0.5 cd/lm</p> <p>LEDs/each optic 1</p> <p>Light colour White</p> <p>Required components: C17580_STRADA-2X2-SHD-WHT</p>	
<p>OSRAM Opto Semiconductors</p> <p>LED OSCONIQ P 3737 (3W version)</p> <p>FWHM / FWTM Asymmetric</p> <p>Efficiency 91 %</p> <p>Peak intensity 0.7 cd/lm</p> <p>LEDs/each optic 1</p> <p>Light colour White</p> <p>Required components:</p>	
<p>OSRAM Opto Semiconductors</p> <p>LED OSLON Square CSSRM2/CSSRM3</p> <p>FWHM / FWTM Asymmetric</p> <p>Efficiency 80 %</p> <p>Peak intensity 0.6 cd/lm</p> <p>LEDs/each optic 1</p> <p>Light colour White</p> <p>Required components: C17580_STRADA-2X2-SHD-WHT</p>	
<p>OSRAM Opto Semiconductors</p> <p>LED OSLON Square CSSRM2/CSSRM3</p> <p>FWHM / FWTM Asymmetric</p> <p>Efficiency 80 %</p> <p>Peak intensity 0.6 cd/lm</p> <p>LEDs/each optic 1</p> <p>Light colour White</p> <p>Required components: C17677_STRADA-2X2-SHD-BLK</p>	

OPTICAL RESULTS (SIMULATED):

OSRAM

Opto Semiconductors

LED OSLON Square CSSRM2/CSSRM3
 FWHM / FWTM Asymmetric
 Efficiency 74 %
 Peak intensity 0.5 cd/lm
 LEDs/each optic 1
 Light colour White
 Required components:

Protective plate, glass

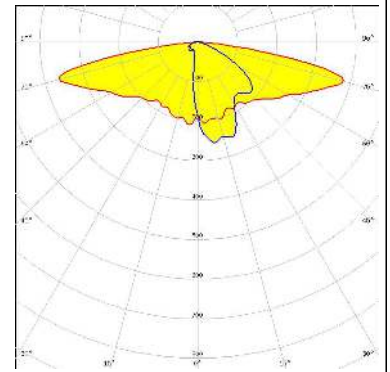

OSRAM

Opto Semiconductors

LED OSLON Square CSSRM2/CSSRM3
 FWHM / FWTM Asymmetric
 Efficiency 62 %
 Peak intensity 0.4 cd/lm
 LEDs/each optic 1
 Light colour White
 Required components:

C17580_STRADA-2X2-SHD-WHT

Protective plate, glass

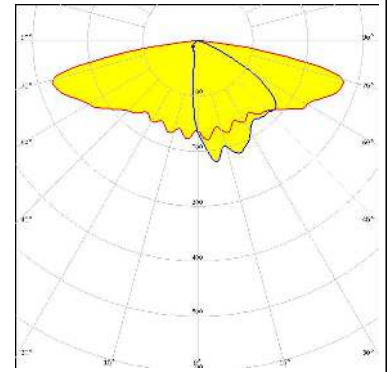

PHILIPS

LED Fortimo FastFlex LED 2x8 DA G5
 FWHM / FWTM Asymmetric
 Efficiency 77 %
 Peak intensity 0.5 cd/lm
 LEDs/each optic 1
 Light colour White
 Required components:

Protective plate, glass

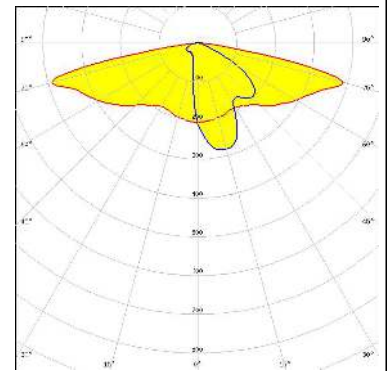

PHILIPS

LED Fortimo FastFlex LED 2x8 DA HE
 FWHM / FWTM Asymmetric
 Efficiency 75 %
 Peak intensity 0.4 cd/lm
 LEDs/each optic 1
 Light colour White
 Required components:

Protective plate, glass

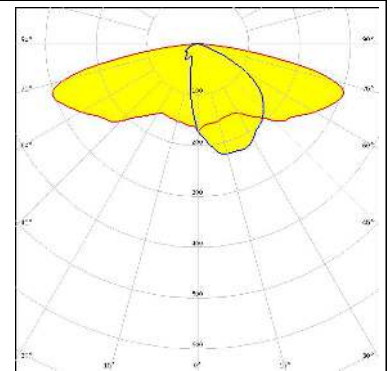

OPTICAL RESULTS (SIMULATED):

PHILIPS

LED Fortimo FastFlex LED 2x8 DA HE
 FWHM / FWTM Asymmetric
 Efficiency 93 %
 Peak intensity 0.6 cd/lm
 LEDs/each optic 1
 Light colour White
 Required components:

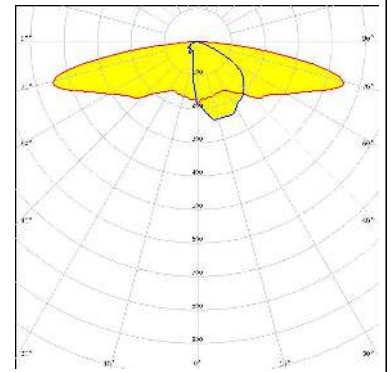

PHILIPS

LED Fortimo FastFlex LED 2x8 DAX G4
 FWHM / FWTM Asymmetric
 Efficiency 90 %
 Peak intensity 0.8 cd/lm
 LEDs/each optic 1
 Light colour White
 Required components:

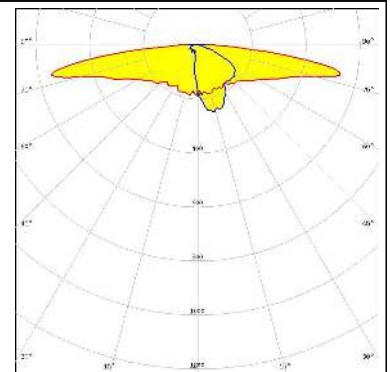

SAMSUNG

LED HiLOM RH12 Z (LH351C)
 FWHM / FWTM Asymmetric
 Efficiency 77 %
 Peak intensity 0.5 cd/lm
 LEDs/each optic 1
 Light colour White
 Required components:

Protective plate, glass

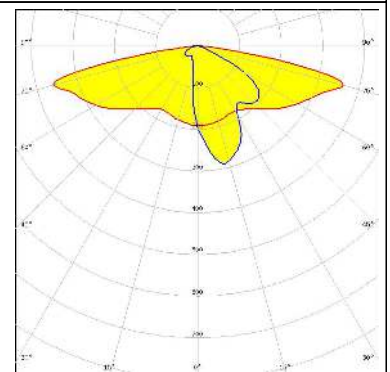

SAMSUNG

LED HiLOM RM8 Z (LH502C)
 FWHM / FWTM Asymmetric
 Efficiency 81 %
 Peak intensity 0.5 cd/lm
 LEDs/each optic 1
 Light colour White
 Required components:

Protective plate, glass

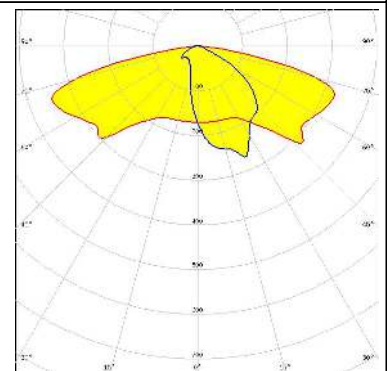

OPTICAL RESULTS (SIMULATED):

SAMSUNG

LED LH181B
 FWHM / FWTM Asymmetric
 Efficiency 92 %
 Peak intensity 0.8 cd/lm
 LEDs/each optic 1
 Light colour White
 Required components:

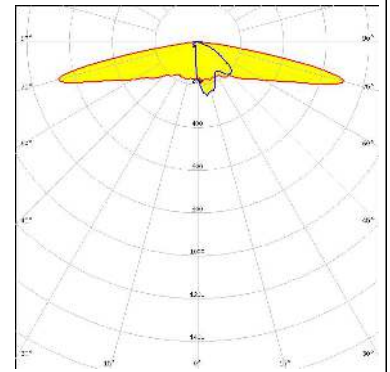

SAMSUNG

LED LH231B
 FWHM / FWTM Asymmetric
 Efficiency 90 %
 Peak intensity 0.8 cd/lm
 LEDs/each optic 1
 Light colour White
 Required components:

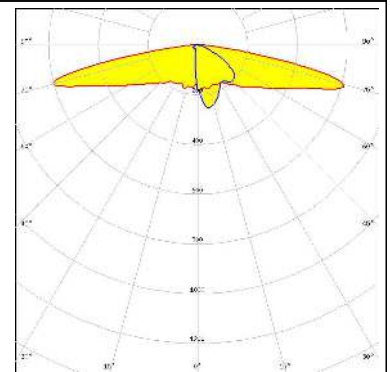

SAMSUNG

LED LH351B
 FWHM / FWTM Asymmetric
 Efficiency 59 %
 Peak intensity 0.4 cd/lm
 LEDs/each optic 1
 Light colour White
 Required components:
 C17677_STRADA-2X2-SHD-BLK

Protective plate, glass

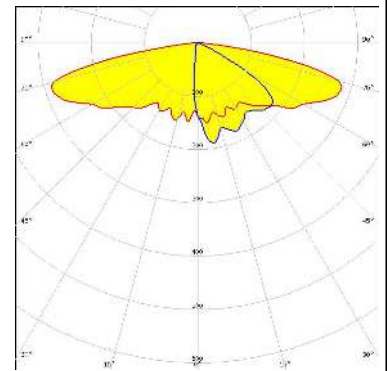

SAMSUNG

LED LH351B
 FWHM / FWTM Asymmetric
 Efficiency 73 %
 Peak intensity 0.4 cd/lm
 LEDs/each optic 1
 Light colour White
 Required components:

Protective plate, glass

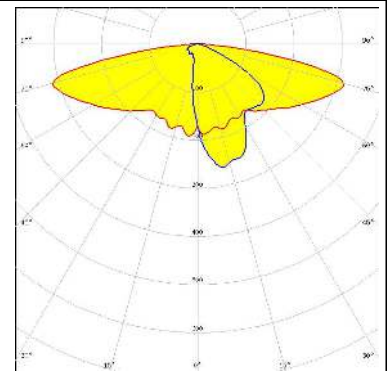

OPTICAL RESULTS (SIMULATED):

SAMSUNG

LED LH351C
 FWHM / FWTM Asymmetric
 Efficiency 68 %
 Peak intensity 0.4 cd/lm
 LEDs/each optic 1
 Light colour White
 Required components:
 C17580_STRADA-2X2-SHD-WHT

Protective plate, glass

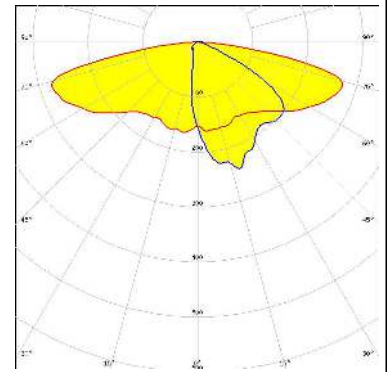

SAMSUNG

LED LH351C
 FWHM / FWTM Asymmetric
 Efficiency 59 %
 Peak intensity 0.4 cd/lm
 LEDs/each optic 1
 Light colour White
 Required components:
 C17677_STRADA-2X2-SHD-BLK

Protective plate, glass

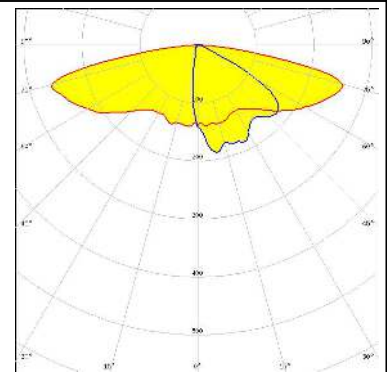

SAMSUNG

LED LH351C
 FWHM / FWTM Asymmetric
 Efficiency 75 %
 Peak intensity 0.4 cd/lm
 LEDs/each optic 1
 Light colour White
 Required components:

Protective plate, glass

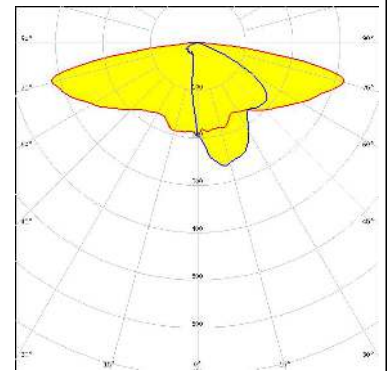





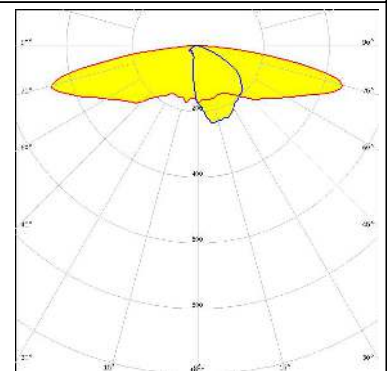

SAMSUNG

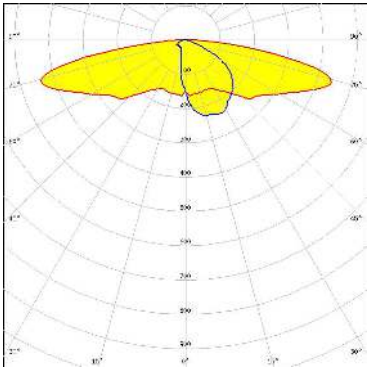

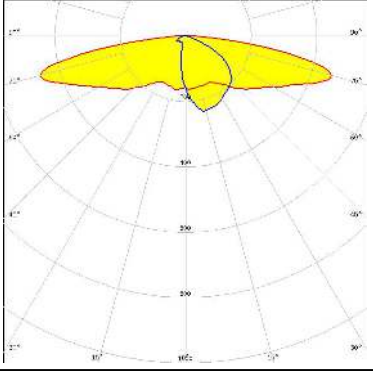

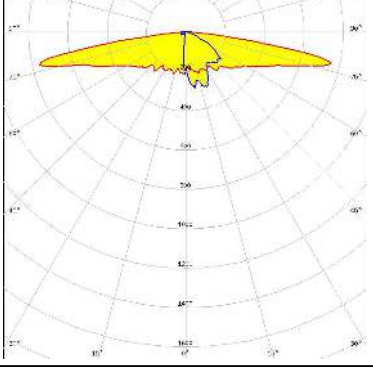

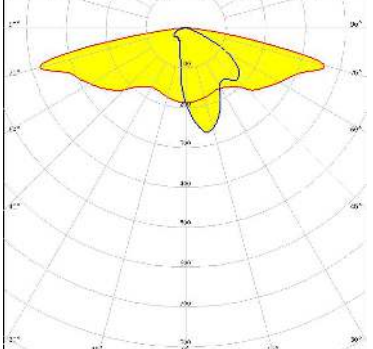
LED LH502D
 FWHM / FWTM Asymmetric
 Efficiency 91 %
 Peak intensity 0.6 cd/lm
 LEDs/each optic 1
 Light colour White
 Required components:

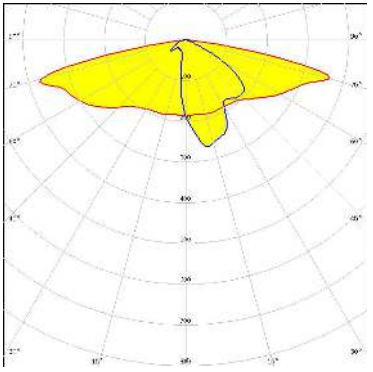

OPTICAL RESULTS (SIMULATED):

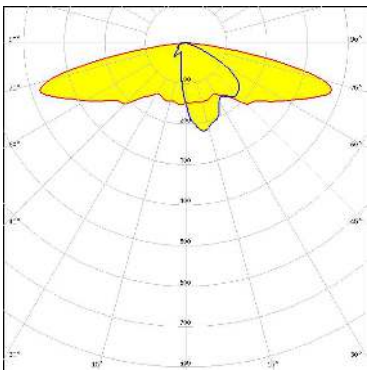
<p> SEOUL SEMICONDUCTOR</p> <p>LED MJT 5050</p> <p>FWHM / FWTM Asymmetric</p> <p>Efficiency 92 %</p> <p>Peak intensity 0.6 cd/lm</p> <p>LEDs/each optic 1</p> <p>Light colour White</p> <p>Required components:</p>	
<p> SEOUL SEMICONDUCTOR</p> <p>LED SEOUL DC 5050 6V</p> <p>FWHM / FWTM Asymmetric</p> <p>Efficiency 92 %</p> <p>Peak intensity 0.6 cd/lm</p> <p>LEDs/each optic 1</p> <p>Light colour White</p> <p>Required components:</p>	
<p> SEOUL SEMICONDUCTOR</p> <p>LED Z5M1/Z5M2</p> <p>FWHM / FWTM Asymmetric</p> <p>Efficiency %</p> <p>LEDs/each optic 1</p> <p>Light colour White</p> <p>Required components:</p>	
<p> SEOUL SEMICONDUCTOR</p> <p>LED Z5M3</p> <p>FWHM / FWTM Asymmetric</p> <p>Efficiency 75 %</p> <p>Peak intensity 0.5 cd/lm</p> <p>LEDs/each optic 1</p> <p>Light colour White</p> <p>Required components:</p> <div style="border: 1px solid black; background-color: #ADD8E6; padding: 2px; display: inline-block; margin-top: 5px;">Protective plate, glass</div>	

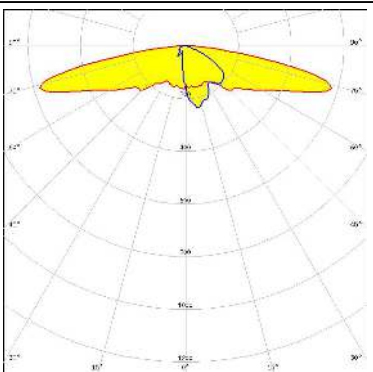
OPTICAL RESULTS (SIMULATED):

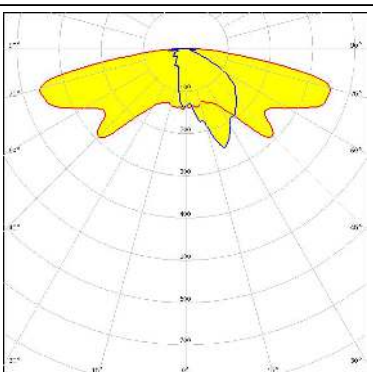
<p> SEOUL SEMICONDUCTOR</p> <p>LED: Z5M4 FWHM / FWTM: Asymmetric Efficiency: 77 % Peak intensity: 0.5 cd/lm LEDs/each optic: 1 Light colour: White</p> <p>Required components:</p> <p>Protective plate, glass</p>	
<p> SEOUL SEMICONDUCTOR</p> <p>LED: Z5M5 FWHM / FWTM: Asymmetric Efficiency: 75 % Peak intensity: 0.5 cd/lm LEDs/each optic: 1 Light colour: White</p> <p>Required components:</p> <p>Protective plate, glass</p>	
<p> SEOUL SEMICONDUCTOR</p> <p>LED: Z5M5 FWHM / FWTM: Asymmetric Efficiency: 93 % Peak intensity: 0.7 cd/lm LEDs/each optic: 1 Light colour: White</p> <p>Required components:</p>	
<p> SEOUL SEMICONDUCTOR</p> <p>LED: Z8Y19 FWHM / FWTM: Asymmetric Efficiency: 91 % Peak intensity: 0.5 cd/lm LEDs/each optic: 4 Light colour: White</p> <p>Required components:</p>	

OPTICAL RESULTS (SIMULATED):

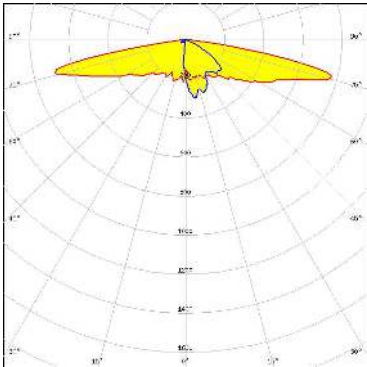
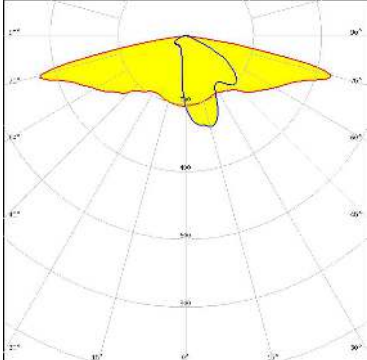
<p>TOSHIBA Leading Innovation »»</p> <p>LED TL1L4 FWHM / FWTM Asymmetric Efficiency % LEDs/each optic 1 Light colour White Required components:</p>	
<p>TRIDONIC</p> <p>LED RLE 2x8 4000lm HP EXC2 OTD FWHM / FWTM Asymmetric Efficiency 79 % Peak intensity 0.6 cd/lm LEDs/each optic 1 Light colour White Required components:</p> <p style="background-color: #ADD8E6; padding: 2px;">Protective plate, glass</p>	

GENERAL INFORMATION:

NOTE: The typical beam angle will be changed by different color, chip size and chip position tolerance. The typical total beam angle is the full angle measured where the luminous intensity is half of the peak value.

MATERIALS:

As part of our continuous research and improvement processes, and to ensure the best possible quality and availability of our products, LEDiL reserves the right to change material grades without notice.

PRODUCT DATA USER AGREEMENT AND DISCLAIMER:

The measured data in the provided downloadable LEDiL Product Datasheets and Mechanical 2D-Drawings is rounded and provided as reference for planning. LEDiL Oy's optical specifications have been verified by conducting performance testing of the products in accordance with the company's quality system. The reported data are averaged results of multiple measurements with typical variation. LEDiL Oy reserves the right to without prior notification make changes and improvements to its products.

LEDiL Oy assumes neither warranty, nor guarantee nor any other liability of any kind for the contents and correctness of the provided data. The provided data has been generated with highest diligence but the provided data may in reality not represent the complete possible variation range of all intrinsic parameters. Therefore, in certain cases a deviation from the provided data could occur.

LEDiL Oy reserves the right to undertake technical changes of its products without further notification which could lead to changes in the provided data. LEDiL Oy assumes no liability of any kind for the possible deviation from any provided data or any other damage resulting from the usage of the provided data.

The user agrees to this disclaimer and user agreement with the download or usage of the provided files.

LEDiL Oy

Joensuunkatu 13
FI-24240 SALO
Finland

LEDiL Inc.

228 West Page Street
Suite D
Sycamore IL 60178
USA

Ledil Optics Technology (Shenzhen) Co., Ltd.

405 , Block B
Casic Motor Building
Shenzhen 518057
P.R.CHINA

Local sales and technical support

[www.ledil.com/
where_to_buy](http://www.ledil.com/where_to_buy)

Shipping locations

Salo, Finland
Hong Kong, China

Distribution Partners

[www.ledil.com/
where_to_buy](http://www.ledil.com/where_to_buy)