

ezo-co2TM

Embedded NDIR CO2 Sensor

Reads	Gaseous CO2
Range	0 – 10,000 ppm
Calibration	Factory calibrated
Pressure	Atmosphere only
Response time	1 reading per second
Resolution	1 ppm
Accuracy	(+/- 5%) + (+/- 50 ppm)
Connector	5 lead data cable
Warmup time	10 seconds
Cable length	1 meter
Data protocol	UART & I²C
Default I ² C address	105 (0x69)
Data format	ASCII
Operating voltage	3.3V – 5V
Life expectancy	~5.5 years



Table of contents

Operating principle	6	Sensor warm-up	9
Physical properties	7	Calibration theory	10
Sensor properties	7	Custom calibration	10
Pin out	8	Default state	11
		Available data protocol	12

UART

UART mode	14
Receiving data from device	15
Sending commands to device	16
LED color definition	17
UART quick command page	18
LED control	19
Find	20
Continuous mode	21
Single reading mode	22
Alarm	23
Custom calibration	24
Enable/disable internal temp	25
Naming device	26
Device information	27
Response codes	28
Reading device status	29
Sleep mode/low power	30
Change baud rate	31
Protocol lock	32
Factory reset	33
Change to I2C mode	34
Manual switching to I2C	35

I²C

I ² C mode	37
Sending commands	38
Requesting data	39
Response codes	40
Processing delay	40
LED color definition	41
I²C quick command page	42
LED control	43
Find	44
Taking reading	45
Alarm	46
Custom calibration	47
Enable/disable internal temp	48
Naming device	49
Device information	50
Reading device status	51
Sleep mode/low power	52
Protocol lock	53
I ² C address change	54
Factory reset	55
Change to UART mode	56
Manual switching to UART	57

Datasheet change log	58
Firmware updates	59
Warranty	60

Attention

The EZO-CO2™ is 100% operational out of the box.
CALIBRATION IS UNNECESSARY

This sensor detects
GASEOUS CO2

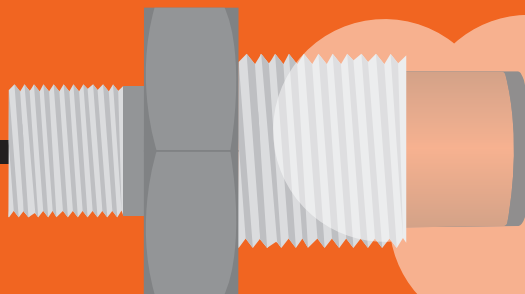

X

This sensor does not
read dissolved CO2.
DO NOT SUBMERGE!

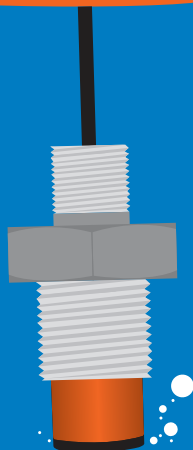

Attention

Do not point the sensor directly at bright lights

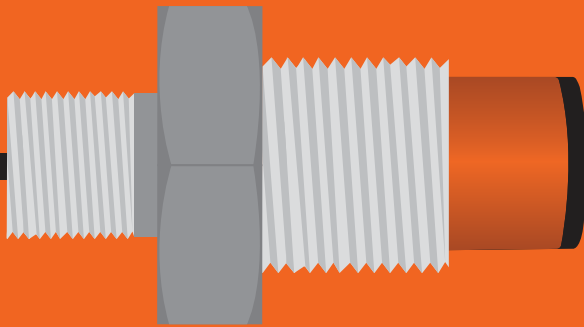

This CO2 sensor uses IR light to detect CO2.

Pointing the sensor directly at a bright light will give false readings. (it will not damage the sensor.)

If the CO2 sensor is returning false readings when in a bright environment, try attaching a PVC Tee to the sensor, to block the direct light.

(or just don't point the sensor at bright lights.)

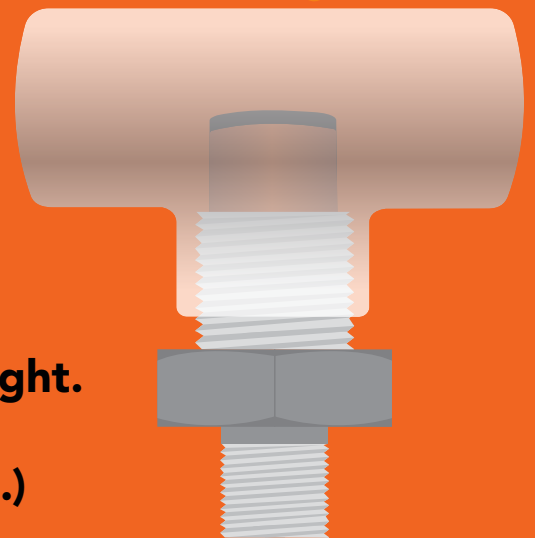

Attention

Do not mount CO2 sensors opposite each other.

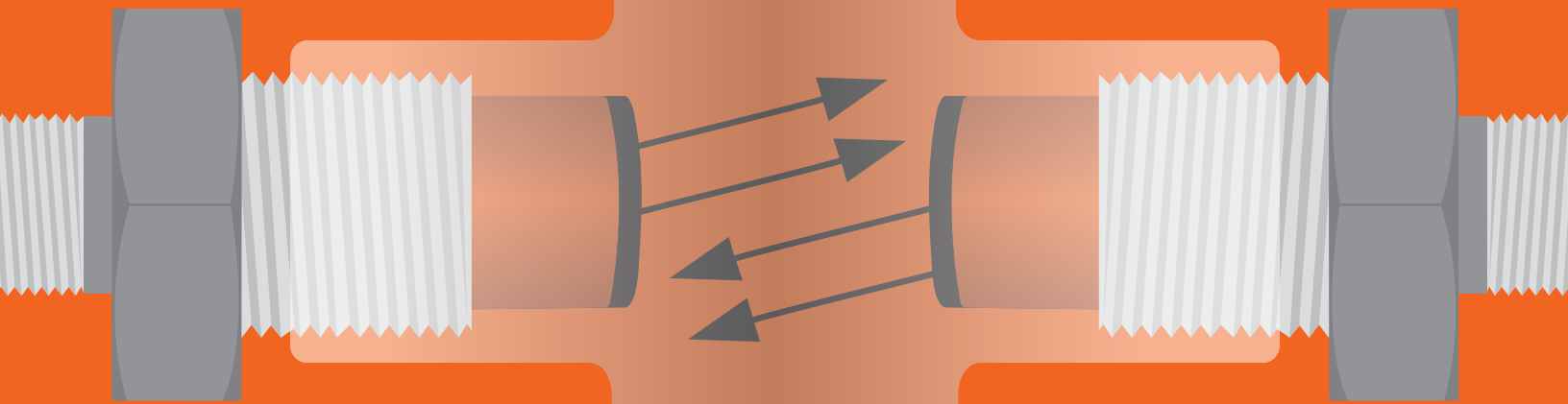

This CO2 sensor emits a small amount of IR light; the opposing sensor will detect that light. Over several hours the CO2 readings will become unstable and take on a sine wave appearance.

Operating principle

The Atlas Scientific EZO-CO2™ Embedded CO2 Sensor uses a non-dispersive infra-red (NDIR) gas detection cell to derive CO2 content in a gaseous matrix. The NDIR detection cell is a single wavelength spectrophotometer that has been specifically designed to detect 4.2µm infrared radiation.

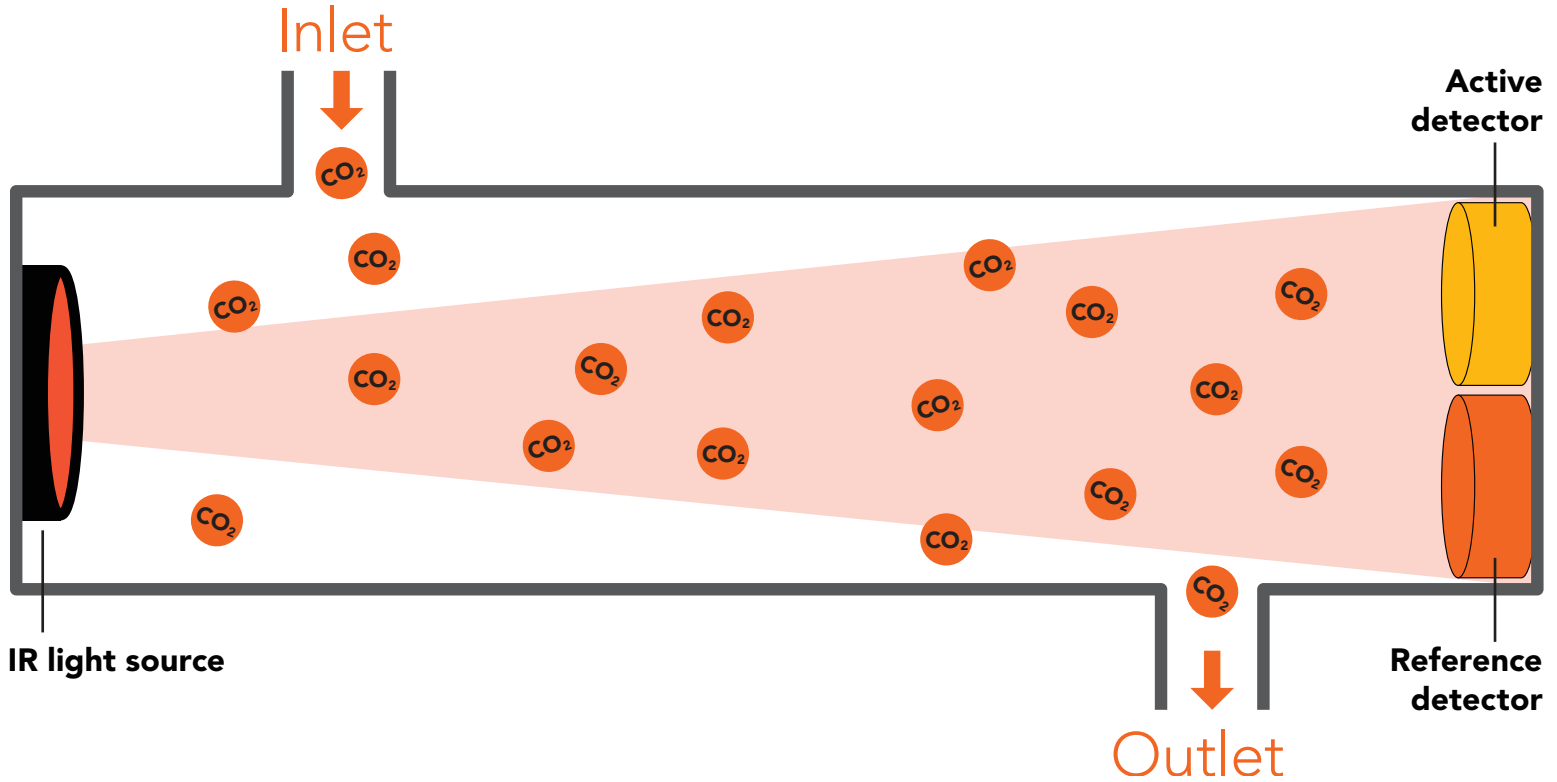

Gaseous CO₂ has a prominent absorption band centered at 4.2µm. CO₂ content is derived by quantifying how much light energy has been lost when it travels through a gaseous matrix over a fixed distance.

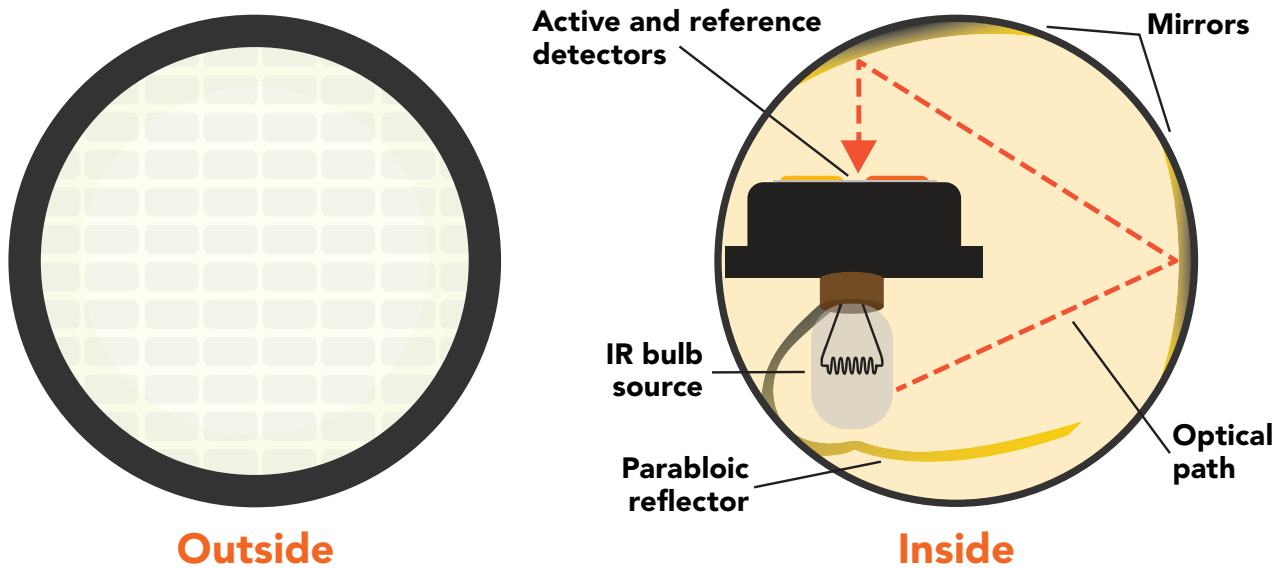

Physical properties

The EZO-CO₂™ sensor only detects gaseous CO₂ levels. This device cannot read dissolved CO₂ levels. **DO NOT SUBMERGE IN LIQUID.**

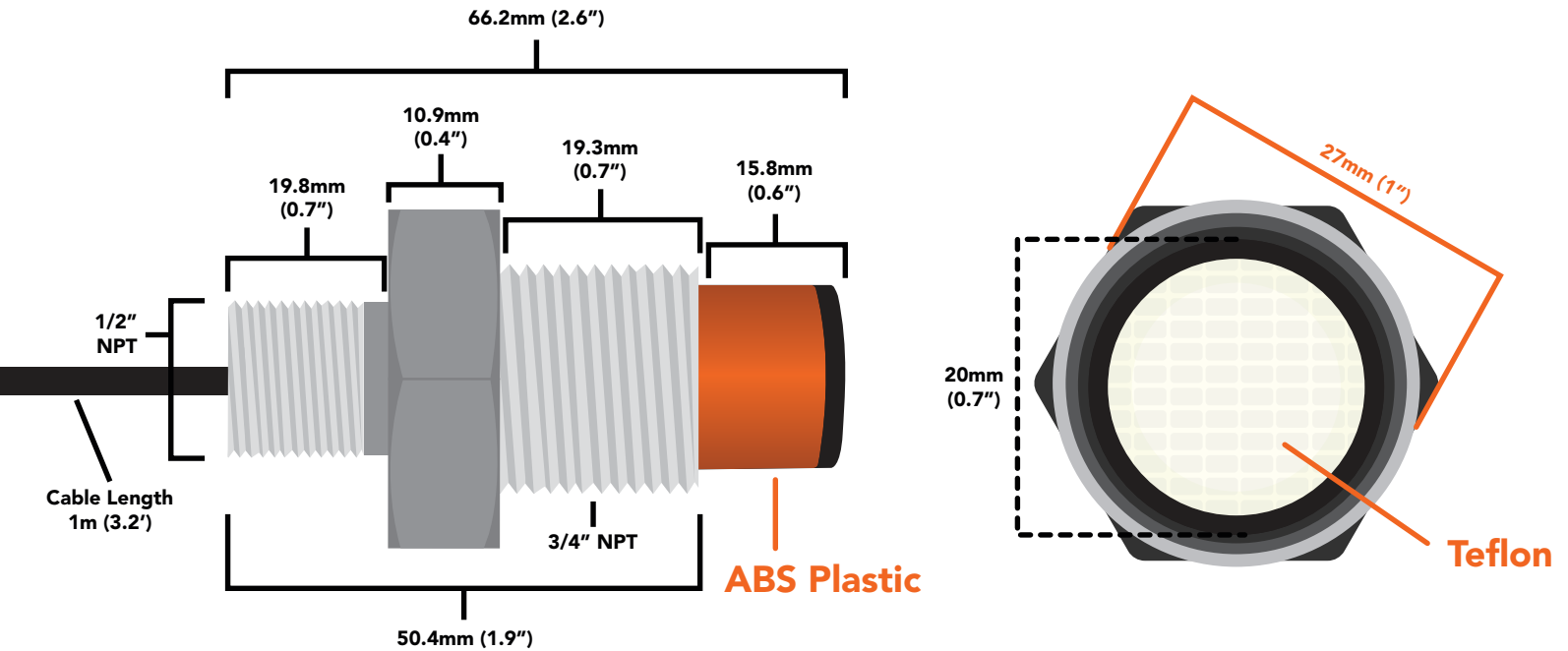

Weight 133g

Body 316 Stainless Steel

IP60



Sensor properties

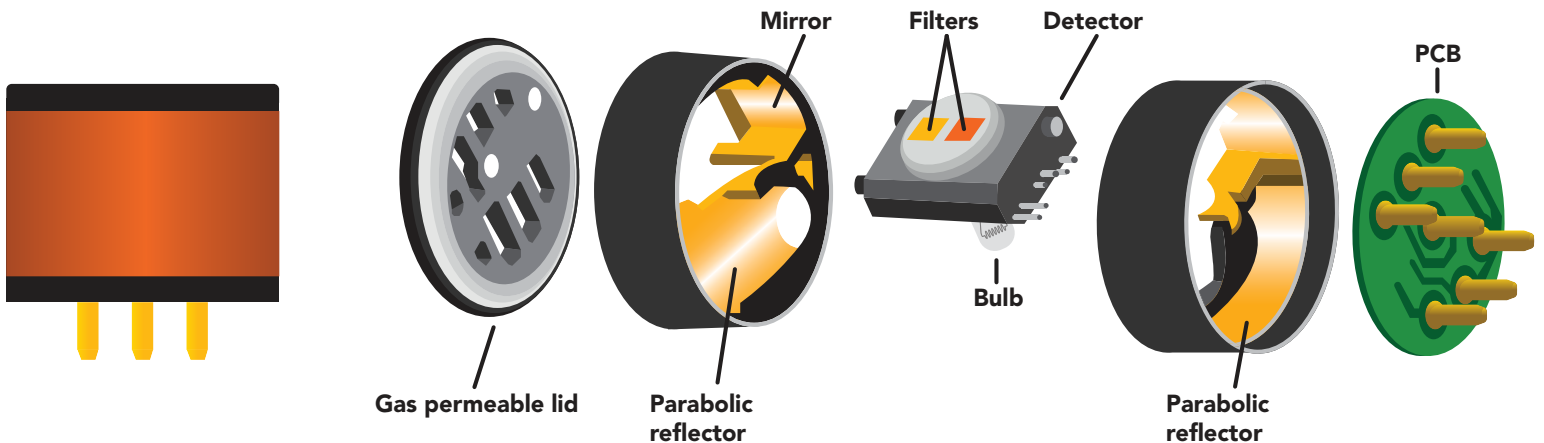

Pin out

Data and power cable pinout

White – RX/SCL
 Green – TX/SDA
 Black – GND
 Red – VCC
 Blue – ALM



The alarm pin will go high when a set CO2 level has been crossed.



If unused leave **ALM** floating. Do not connect **ALM** to **VCC** or **GND**.

See page **23** to enable CO2 level alarm in UART mode.

See page **46** to enable CO2 level alarm in I2C mode.

Power consumption

	LED	MAX	SLEEP
5V	ON	45 mA	3.4 mA
	OFF	44 mA	
3.3V	ON	42 mA	3.0 mA
	OFF	41 mA	

Absolute max ratings

Parameter	MIN	TYP	MAX
Storage temperature	-65 °C		75 °C
Operational temperature	-20 °C	25 °C	50 °C
VCC	3.3V	3.3V	5.5V

Humidity Range 0 to 95% rh non-condensing

IP60

Sensor warm-up

When the Atlas Scientific EZO-CO2™ Embedded CO2 Sensor is first powered on (or wakes up from sleep mode) the sensor must warm-up before it can output readings. The warm-up process takes 10 seconds to complete.

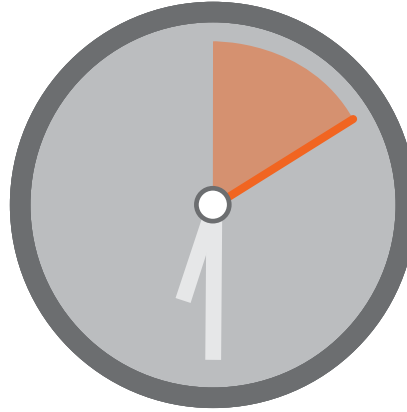
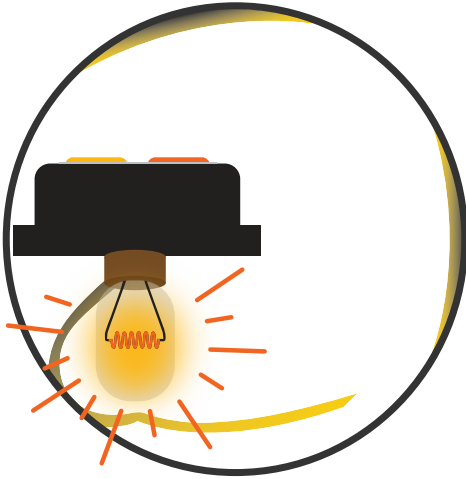

10 sec

During the first 10 seconds of operation the output will be: ***warm**

Once warming is finished, CO2 readings will be output. The device will continue to warm-up over several minutes. As the internal temperature stabilizes, so will the CO2 readings.

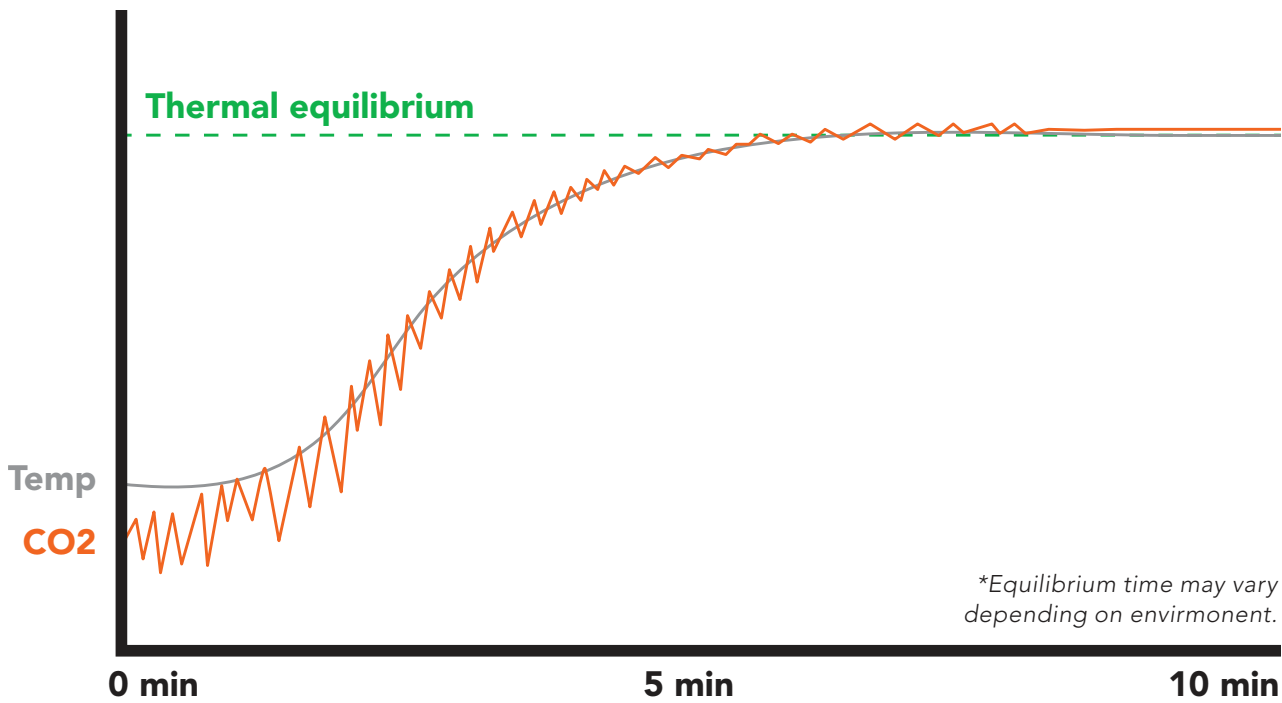

To see the internal temperature of the sensor and watch as it stabilizes, use the 'O' command found on page 25.

Calibration theory

The Atlas Scientific EZO-CO2™ Embedded CO2 Sensor comes pre-calibrated, and does not need to be recalibrated. Atlas Scientific performs a two-point factory calibration as part of the manufacturing process.

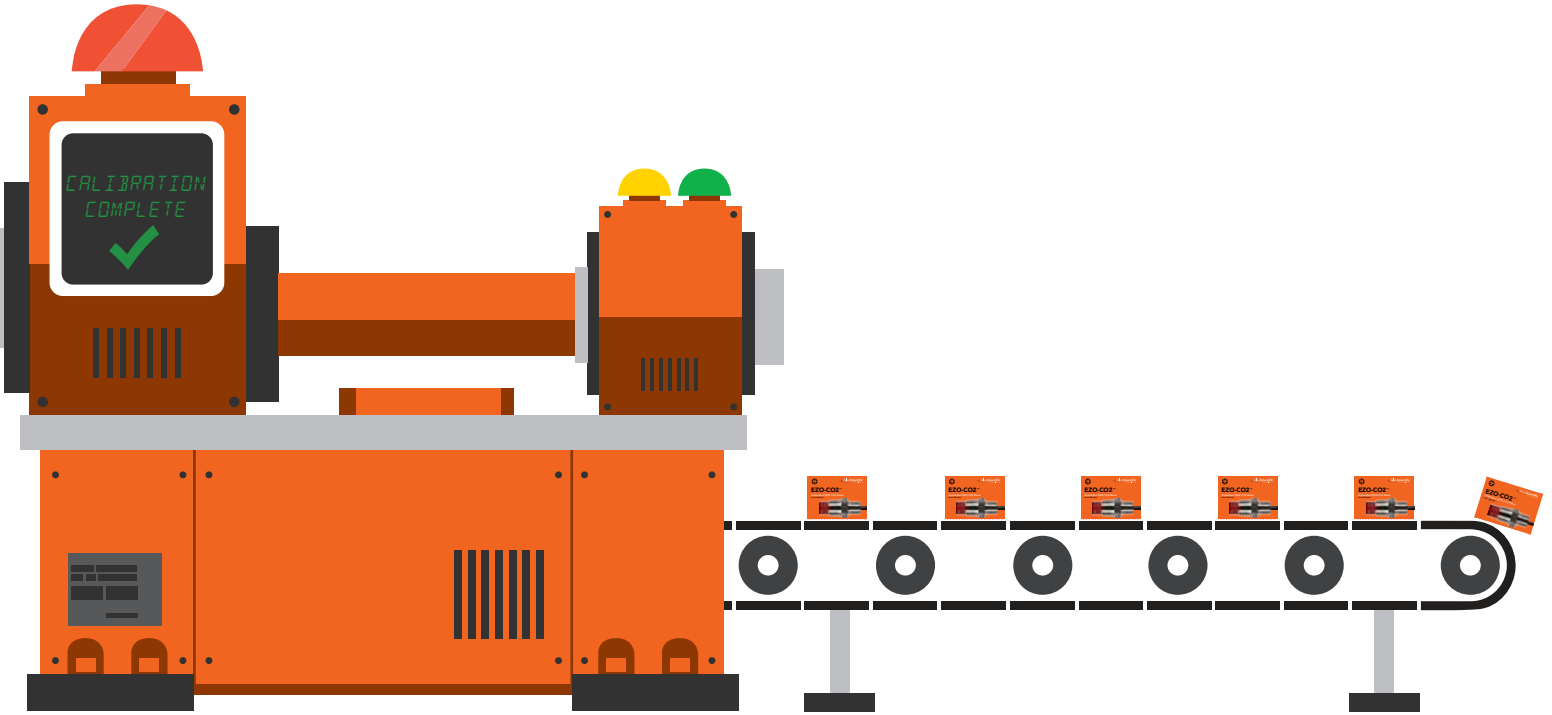

Low point calibration = 0 ppm
High point calibration = 4,000 ppm

The factory calibration data is permanently stored in the sensor and cannot be erased.

Custom calibration

One or two-point calibration can be done at any time. When custom calibration is used, factory calibration will be ignored. To revert back to the factory calibration simply clear the custom calibration.

See page [24](#) or [47](#) for custom calibration commands.

Default state

UART mode

Baud	9,600
Readings	continuous
Speed	1 second
LED	on

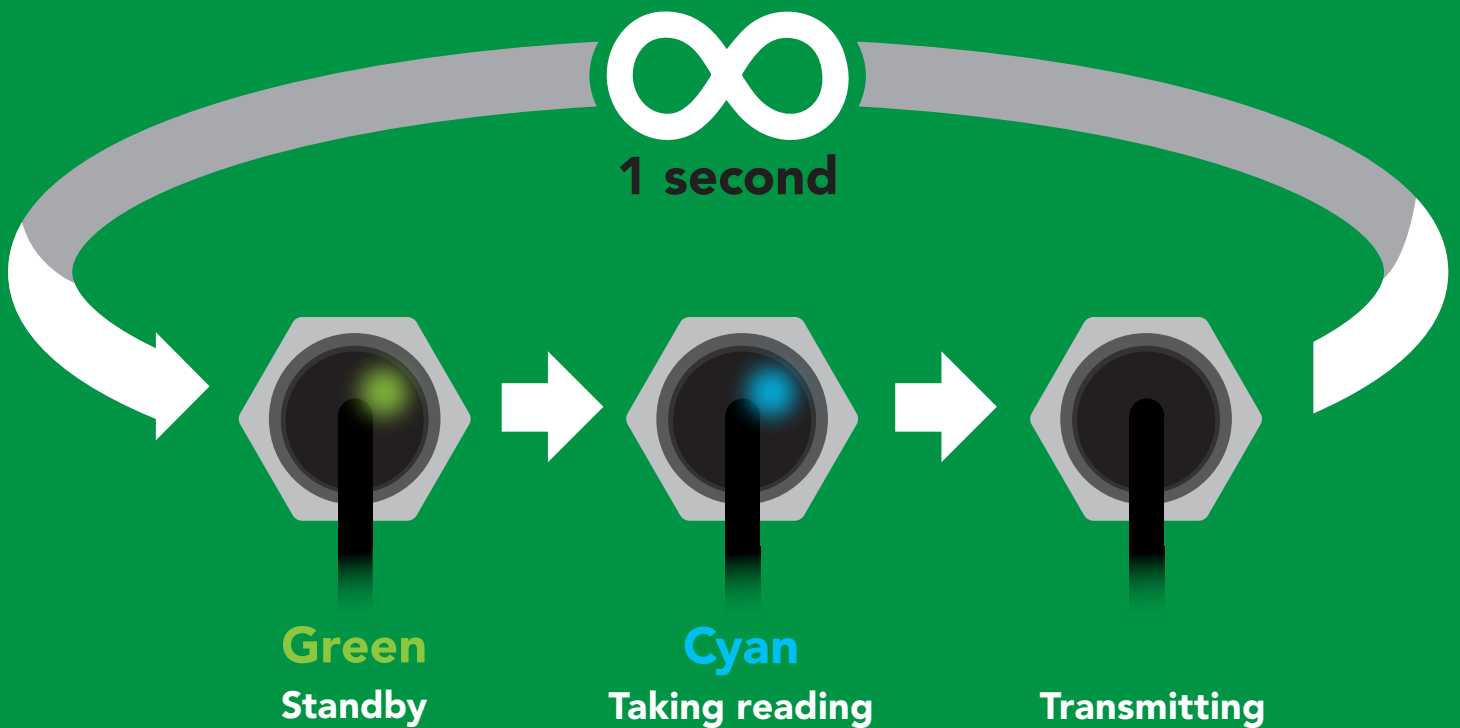

✓ Available data protocols

UART

default

I²C

✗ Unavailable data protocols

SPI

Analog

RS-485

Mod Bus

4–20mA

UART mode

Settings that are retained if power is cut

- Baud rate
- Calibration
- Continuous mode
- Device name
- Enable/disable response codes
- Hardware switch to I²C mode
- LED control
- Protocol lock
- Software switch to I²C mode

Settings that are **NOT** retained if power is cut

- Sleep mode

UART mode

8 data bits no parity
1 stop bit no flow control

Baud 300
1,200
2,400
9,600 default
19,200
38,400
57,600
115,200



Vcc 3.3V – 5V

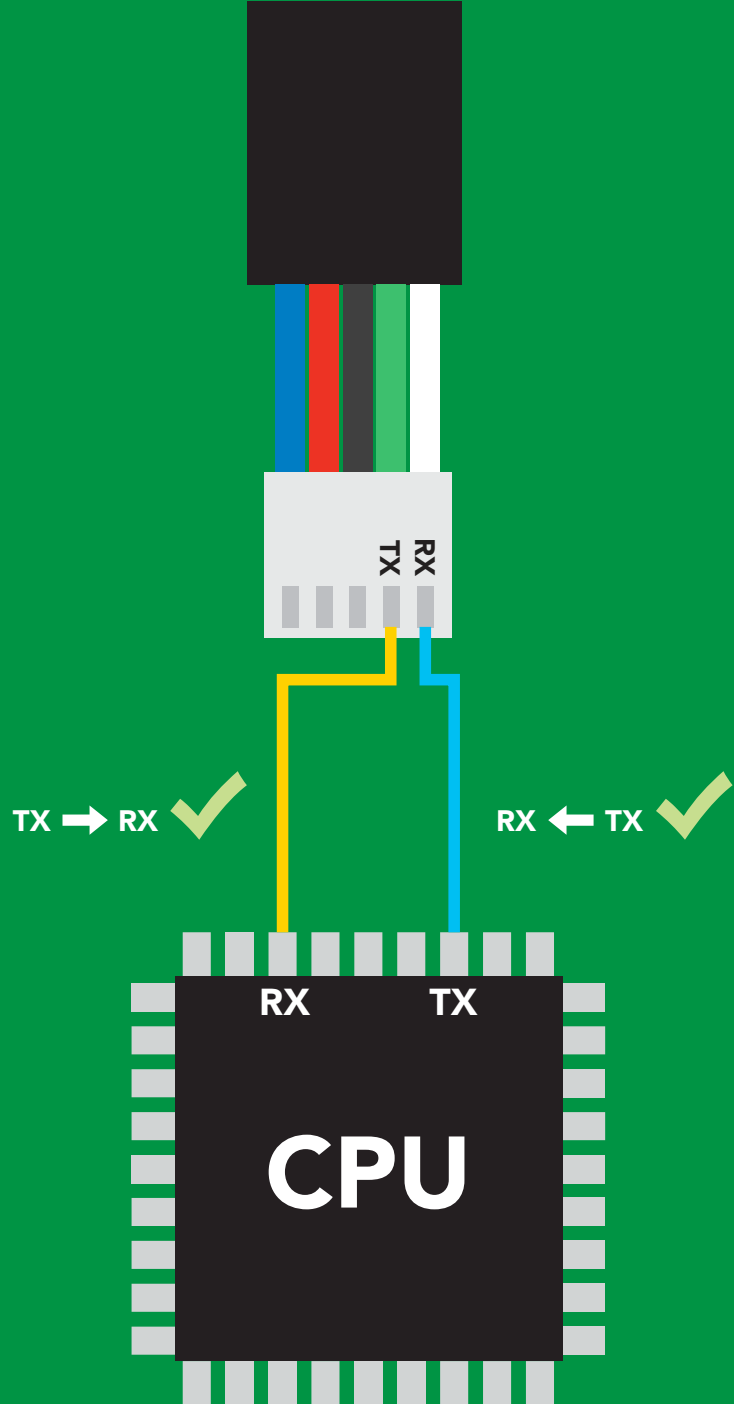

Data format

Reading	Gaseous CO2	Data type	unsigned int
Units	PPM	Decimal places	0
Encoding	ASCII	Smallest string	2 characters
Format	string	Largest string	12 characters
Terminator	carriage return		

Receiving data from device

2 parts

ASCII data string

Command

Carriage return <cr>

Terminator

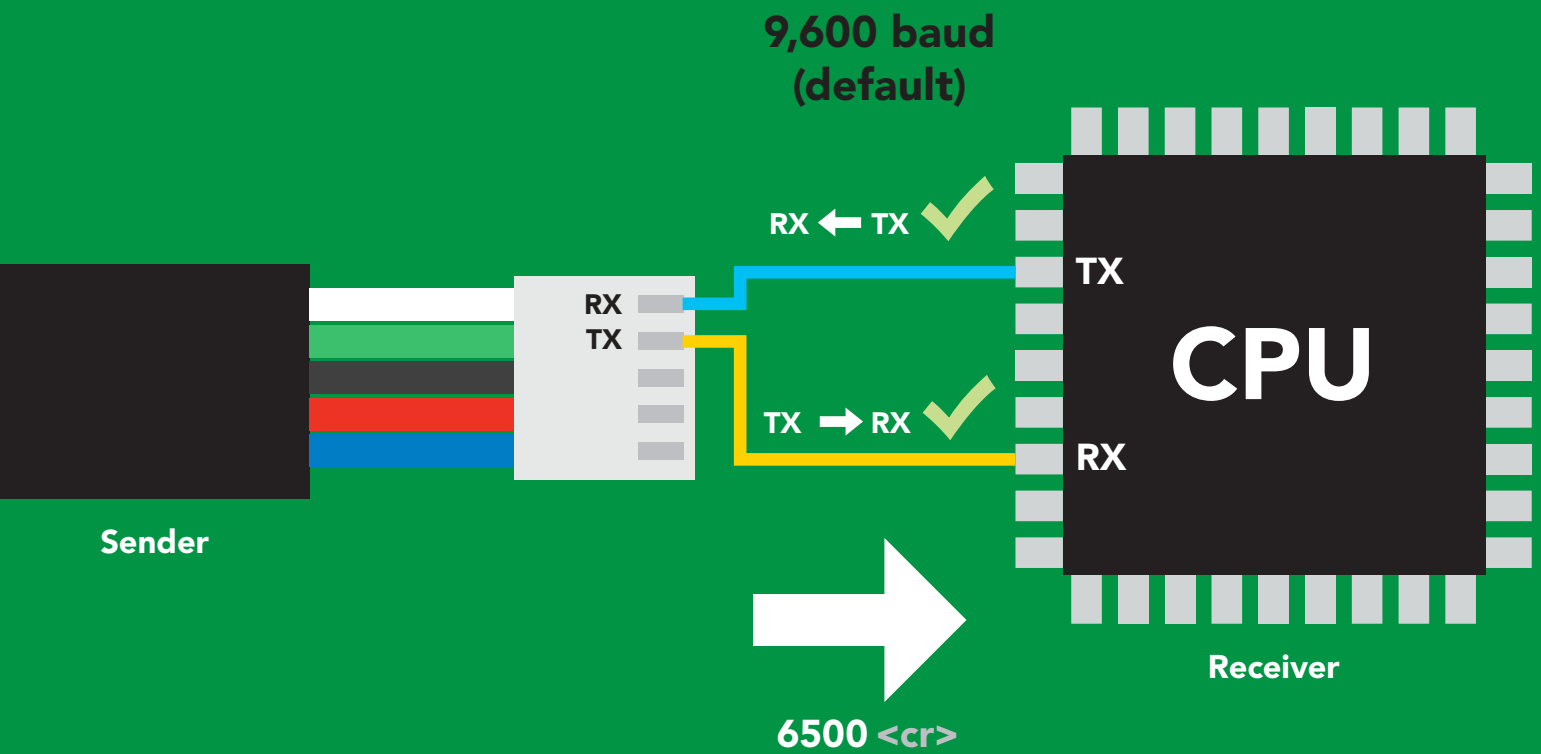

Advanced

ASCII: 6 5 0 0 <cr>

Hex: 36 35 30 30 0D

Dec: 54 53 48 48 13

Sending commands to device

2 parts

Command (not case sensitive)

ASCII data string

Carriage return <cr>

Terminator

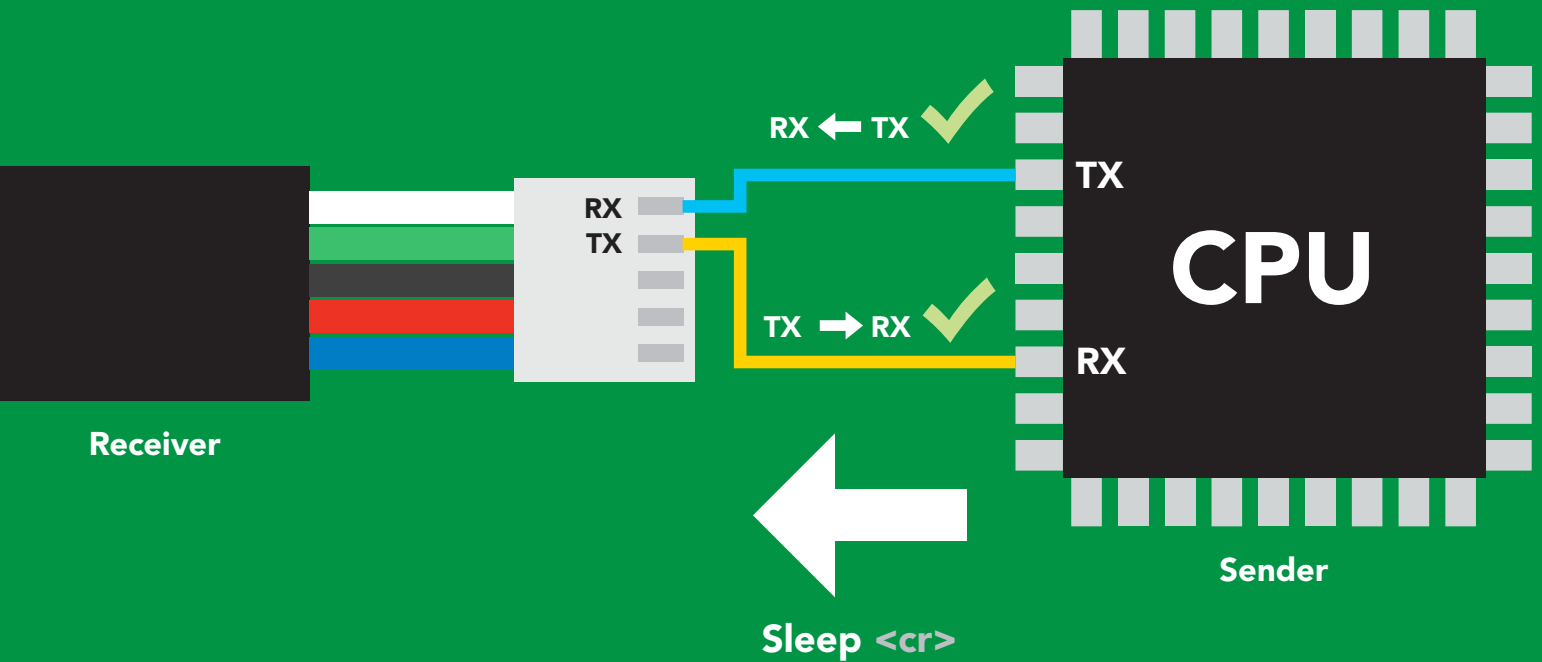

Advanced

ASCII: **S I e e p** <cr>

Hex: **53 6C 65 65 70** **0D**

Dec: **83 108 101 101 112** **13**

LED color definition



Green

UART standby



Cyan

Taking reading



Purple

Changing
baud rate

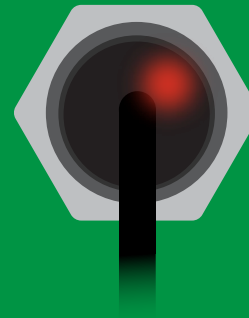

Red

Command
not understood

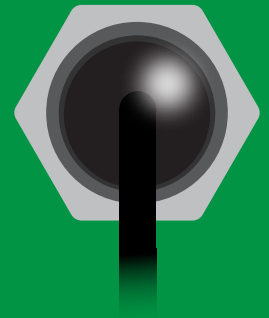

White

Find

5V

LED ON
+2.5 mA

3.3V

+1 mA

UART mode

command quick reference

All commands are ASCII strings or single ASCII characters.

Command	Function		Default state
Alarm	enable/disable alarm	pg. 23	n/a
Baud	change baud rate	pg. 31	9,600
C	enable/disable continuous mode	pg. 21	enabled
Cal	performs custom calibration	pg. 24	n/a
Factory	enable factory reset	pg. 33	n/a
Find	finds device with blinking white LED	pg. 20	n/a
i	device information	pg. 27	n/a
I2C	change to I ² C mode	pg. 34	not set
L	enable/disable LED	pg. 19	enabled
Name	set/show name of device	pg. 26	not set
O	enable/disable internal temperature	pg. 25	disabled
Plock	enable/disable protocol lock	pg. 32	n/a
R	returns a single reading	pg. 22	n/a
Sleep	enter sleep mode/low power	pg. 30	n/a
Status	retrieve Status Information	pg. 29	n/a
*OK	enable/disable response codes	pg. 28	n/a

LED control

Command syntax

L,1 <cr> LED on **default**

L,0 <cr> LED off

L,? <cr> LED state on/off?

Example

Response

L,1 <cr>

*OK <cr>

L,0 <cr>

*OK <cr>

L,? <cr>

?L,1 <cr> or ?L,0 <cr>

*OK <cr>



L,1



L,0

Find

Command syntax

This command will disable continuous mode
Send any character or command to terminate find.

Find <cr> LED rapidly blinks white, used to help find device

Example

Response

Find <cr>

*OK <cr>

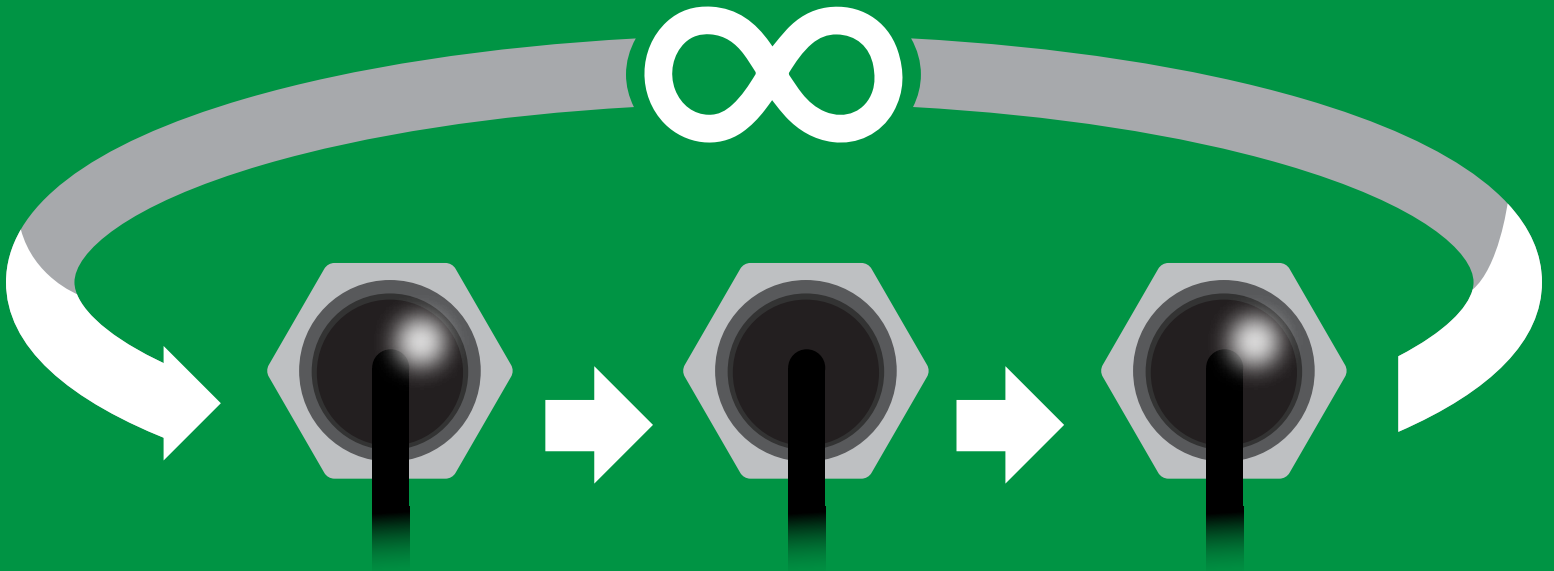

Continuous mode

Command syntax

- C,1 <cr>** enable continuous readings once per second **default**
- C,n <cr>** continuous readings every n seconds (n = 2 to 99 sec)
- C,0 <cr>** disable continuous readings
- C,? <cr>** continuous reading mode on/off?

Example

Response

C,1 <cr>

***OK <cr>**
CO2 (1 sec) <cr>
CO2 (2 sec) <cr>
CO2 (n sec) <cr>

C,30 <cr>

***OK <cr>**
CO2 (30 sec) <cr>
CO2 (60 sec) <cr>
CO2 (90 sec) <cr>

C,0 <cr>

***OK <cr>**

C,? <cr>

?C,1 <cr> or ?C,0 <cr> or ?C,30 <cr>
***OK <cr>**

Single reading mode

Command syntax

R <cr> takes single reading

Example

R <cr>

Response

6500 <cr>

*OK <cr>



Green
Standby



Cyan
Taking reading



Transmitting



1 second

Alarm

Command syntax

The alarm pin will = 1 when CO2 levels are > alarm set point. Alarm tolerance sets how far below the set point CO2 levels need to drop before the pin will = 0 again.

Alarm,en,[1,0] <cr> enable / disable alarm
Alarm,n <cr> sets alarm
Alarm,tol,n <cr> sets alarm tolerance (0 - 500 ppm)
Alarm,? <cr> alarm set?

Example

Response

Alarm,en,1 <cr>

***OK** <cr> Enable alarm

Alarm,1200 <cr>

***OK** <cr>

Alarm,tol,100 <cr>

***OK** <cr> CO2 level must fall 100 ppm below set point for alarm to reset.

Alarm,? <cr>

?,alarm,1200,100,1 <cr> if all are enabled

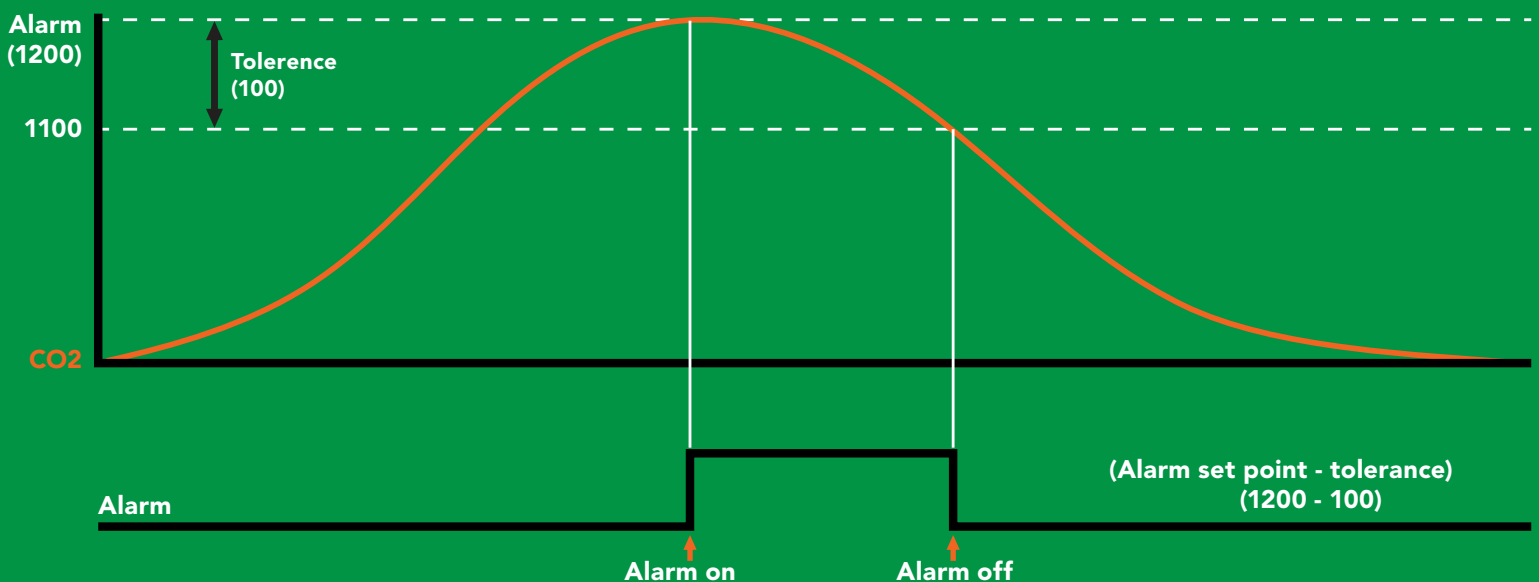

Custom calibration

Command syntax

High point calibration can be from 3,000 ppm to 5,000 ppm. Calibration outside of that range may lead to accuracy issues.

Cal,n	<cr>	calibrates the high point
Cal,0	<cr>	calibrates the zero point
Cal,clear	<cr>	restores calibration to factory settings
Cal,?	<cr>	device calibrated?

Example

Response

Cal,3900 <cr>

*OK <cr>

Cal,0 <cr>

*OK <cr>

Cal,clear <cr>

*OK <cr>

Cal,? <cr>

?Cal,0 <cr> or ?Cal,1 <cr> or ?Cal,2 <cr> or
no calibration only zero point calibration only high point calibration

?Cal,3 <cr> *OK <cr>
zero and high point calibration

This device comes pre-calibrated.

Custom calibration should not be performed without scientific grade calibration gasses.

Enable/disable internal temperature from output string

Command syntax

O,t,[1,0] <cr> enable or disable internal temperature

Example

Response

O,t,1 <cr>

***OK <cr>** enable temperature

O,t,0 <cr>

***OK <cr>** disable temperature

O,? <cr>

?O,ppm,t <cr> if internal temp is enabled

Enabling the internal temperature should only be used to confirm that the device is at thermal equilibrium. Refer to page 6

Naming device

Command syntax

Do not use spaces in the name

Name,n <cr> set name

Name, <cr> clears name

Name,? <cr> show name

n =

1 2 3 4 5 6 7 8 9 10 11 12 13 14 15 16

Up to 16 ASCII characters

Example

Response

Name, <cr>

*OK <cr> name has been cleared

Name,zzt <cr>

*OK <cr>

Name,? <cr>

?Name,zzt <cr>
*OK <cr>

Name,zzt



*OK <cr>

Name,?



?Name,zzt <cr>
*OK <cr>

Device information

Command syntax

```
i <cr> device information
```

Example

```
i <cr>
```

Response

```
?i,CO2,1.0 <cr>  
*OK <cr>
```

Response breakdown

```
?i, CO2, 1.0  
    ↑    ↑  
  Device Firmware
```

Response codes

Command syntax

- *OK,1** <cr> enable response **default**
- *OK,0** <cr> disable response
- *OK,?** <cr> response on/off?

Example

Response

R <cr>

6,500 <cr>
***OK** <cr>

***OK,0** <cr>

no response, ***OK** disabled

R <cr>

6,500 <cr> ***OK** disabled

***OK,?** <cr>

?*OK,1 <cr> or **?*OK,0** <cr>

Other response codes

- *ER** unknown command
- *OV** over volt ($VCC \geq 5.5V$)
- *UV** under volt ($VCC \leq 3.1V$)
- *RS** reset
- *RE** boot up complete, ready
- *SL** entering sleep mode
- *WA** wake up

These response codes
cannot be disabled

Reading device status

Command syntax

Status <cr> voltage at Vcc pin and reason for last restart

Example

```
Status <cr>
```

Response

```
?Status,P,5.038 <cr>  
*OK <cr>
```

Response breakdown

?Status,	P,	5.038
	↑	↑
Reason for restart		Voltage at Vcc

Restart codes

P	powered off
S	software reset
B	brown out
W	watchdog
U	unknown

Sleep mode/low power

Command syntax

Send any character or command to awaken device.

Sleep <cr> enter sleep mode/low power

Example

Response

Sleep <cr>

*OK <cr>

*SL <cr>

Any command

*WA <cr> wakes up device

5V

MAX
45 mA

SLEEP
3.4 mA

3.3V

42 mA

3.0 mA

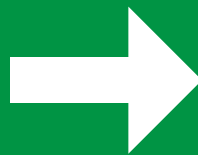

Sleep <cr>



Change baud rate

Command syntax

Baud,n <cr> change baud rate

Example

Baud,38400 <cr>

Response

*OK <cr>

Baud,? <cr>

?Baud,38400 <cr>

*OK <cr>

n =

- 300
- 1200
- 2400
- 9600 default**
- 19200
- 38400
- 57600
- 115200



Standby

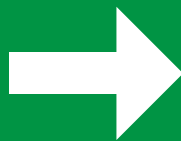

Baud,38400 <cr>

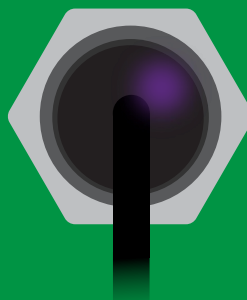

Changing
baud rate

*OK <cr>

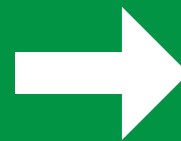

(reboot)



Standby

Protocol lock

Command syntax

Locks device to UART mode.

`Plock,1 <cr>` enable Plock

`Plock,0 <cr>` disable Plock **default**

`Plock,? <cr>` Plock on/off?

Example

Response

`Plock,1 <cr>`

`*OK <cr>`

`Plock,0 <cr>`

`*OK <cr>`

`Plock,? <cr>`

`?Plock,1 <cr>` or `?Plock,0 <cr>`

`Plock,1`



`*OK <cr>`

`I2C,100`

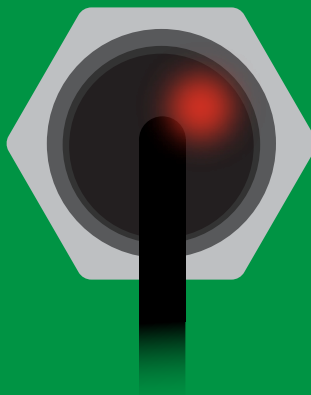

cannot change to I²C

`*ER <cr>`

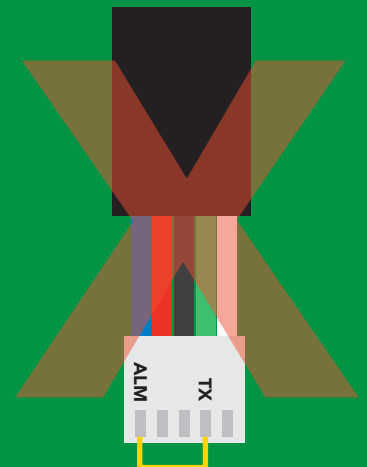

cannot change to I²C

Factory reset

Command syntax

Clears custom calibration
"*OK" enabled

`Factory <cr>` enable factory reset

Example

Response

`Factory <cr>`

`*OK <cr>`

`Factory <cr>`

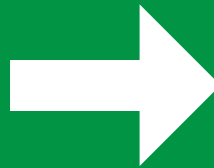

(reboot)



`*OK <cr>`

`*RS <cr>`

`*RE <cr>`

Baud rate will not change

Change to I²C mode

Command syntax

Default I²C address 105 (0x69)

I2C,n <cr> sets I²C address and reboots into I²C mode

n = any number 1 – 127

Example

Response

I2C,100 <cr>

*OK (reboot in I²C mode)

Wrong example

Response

I2C,139 <cr> n ≠ 127

*ER <cr>

I2C,100



Green
*OK <cr>

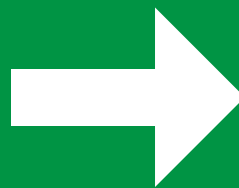

(reboot)



Blue
now in I²C mode

Manual switching to I²C

- Disconnect ground (power off)
- Disconnect TX and RX
- Connect TX to ALM
- Confirm RX is disconnected
- Connect ground (power on)
- Wait for LED to change from **Green** to **Blue**
- Disconnect ground (power off)
- Reconnect all data and power

Manually switching to I²C will set the I²C address to 105 (0x69)

Example

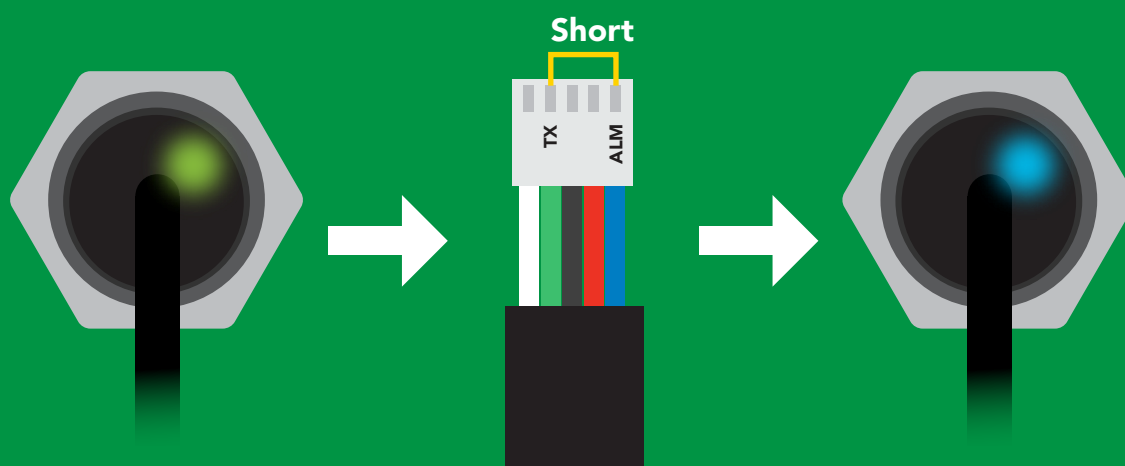

Wrong Example

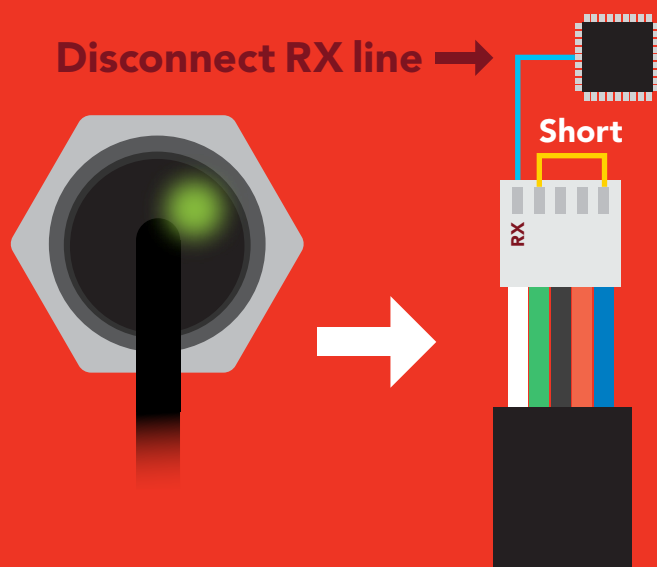

I²C mode

The I²C protocol is **considerably more complex** than the UART (RS-232) protocol. Atlas Scientific assumes the embedded systems engineer understands this protocol.

To set your EZO™ device into I²C mode [click here](#)

Settings that are retained if power is cut

- Calibration
- Change I²C address
- Hardware switch to UART mode
- LED control
- Protocol lock
- Software switch to UART mode

Settings that are **NOT** retained if power is cut

- Sleep mode

I²C mode

I²C address (0x01 – 0x7F)
105 (0x69) default

Vcc 3.3V – 5.5V

Clock speed 100 – 400 kHz

SDA 

SCL 



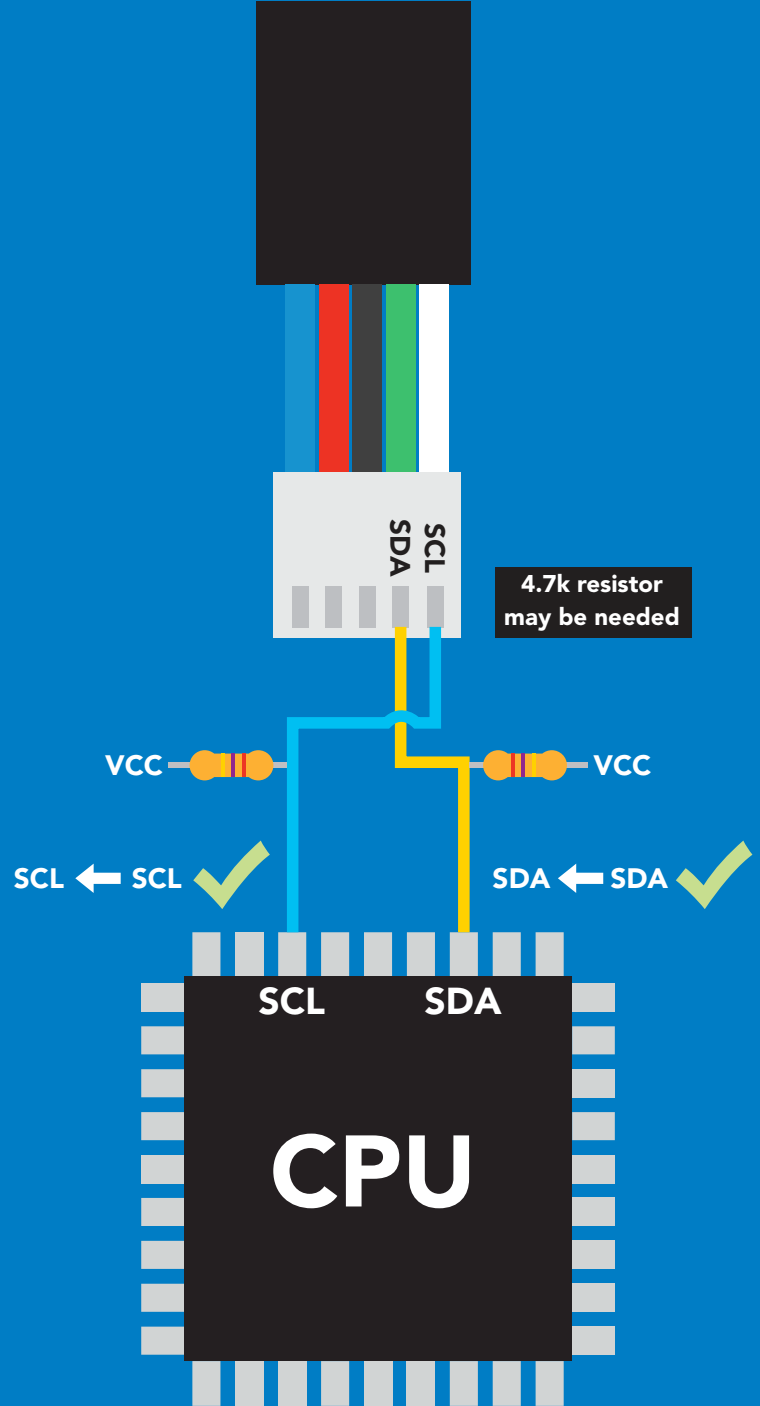

Data format

Reading **Gaseous CO₂**

Units **PPM**

Encoding **ASCII**

Format **string**

Data type **unsigned int**

Decimal places **0**

Smallest string **2 characters**

Largest string **12 characters**

Sending commands to device

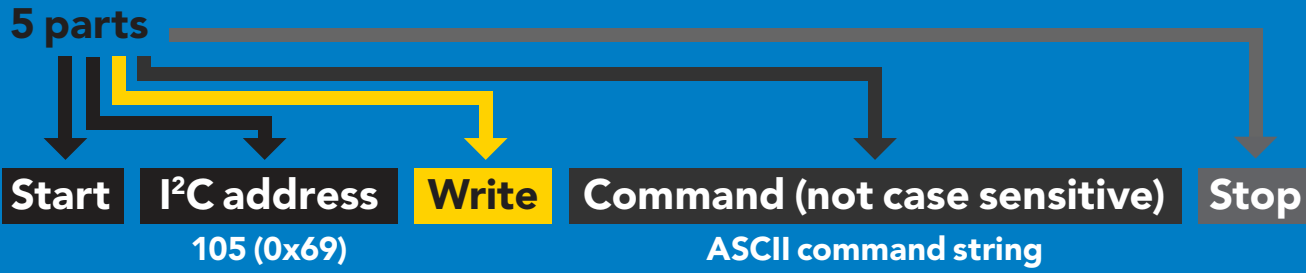

Example

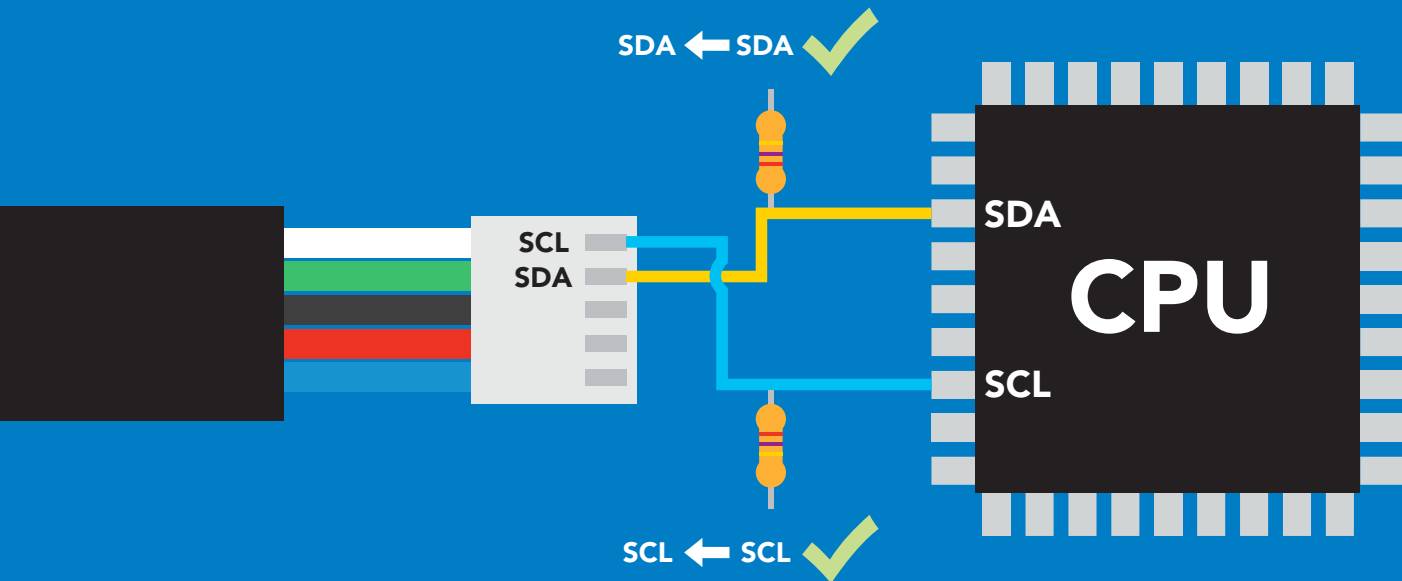

Advanced

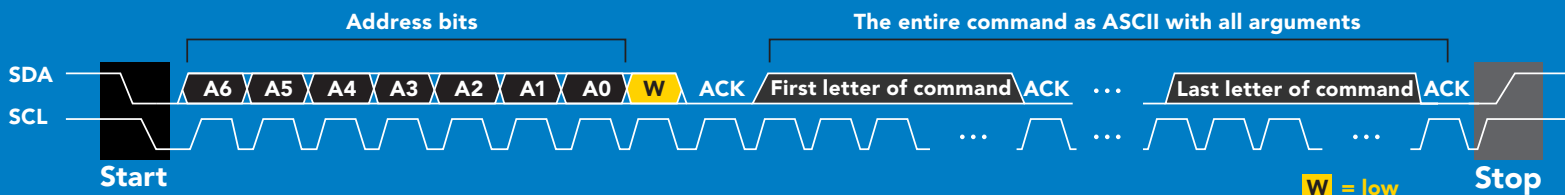

Requesting data from device

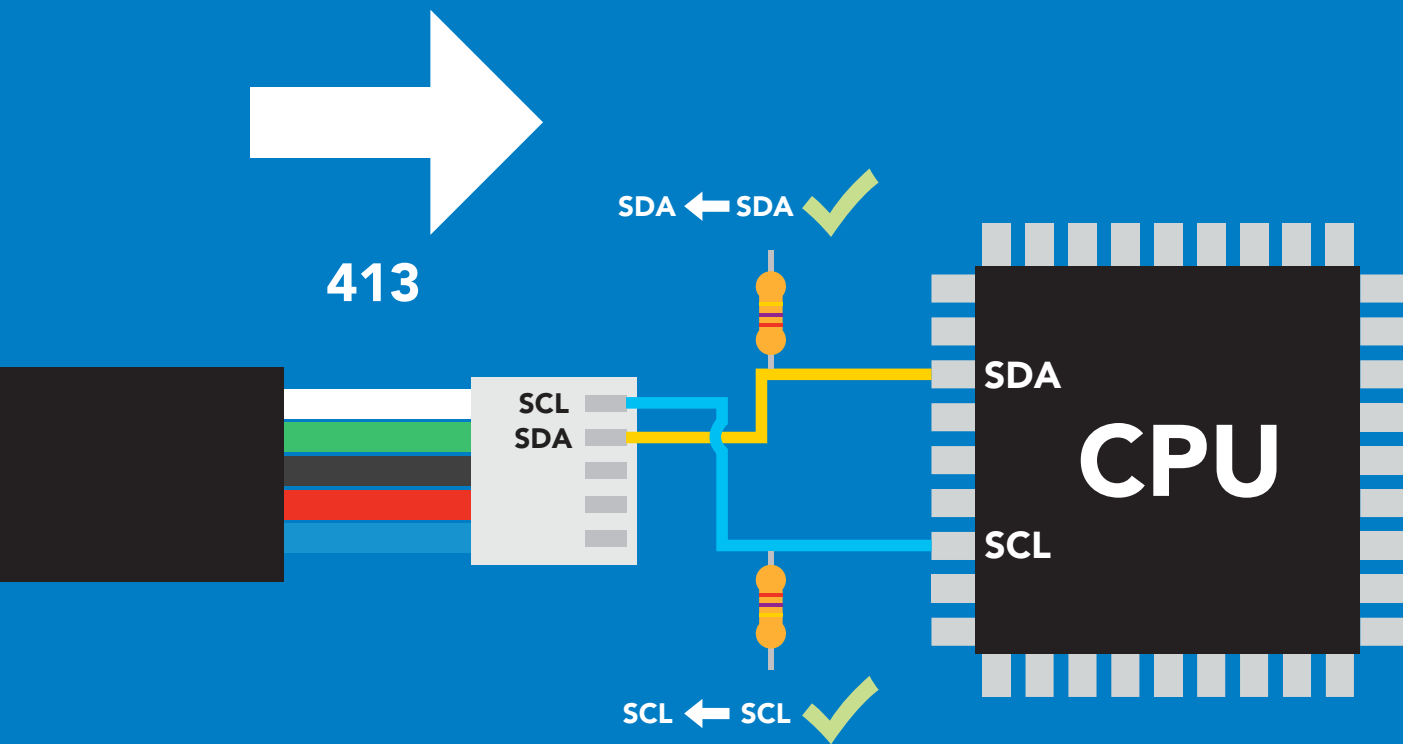
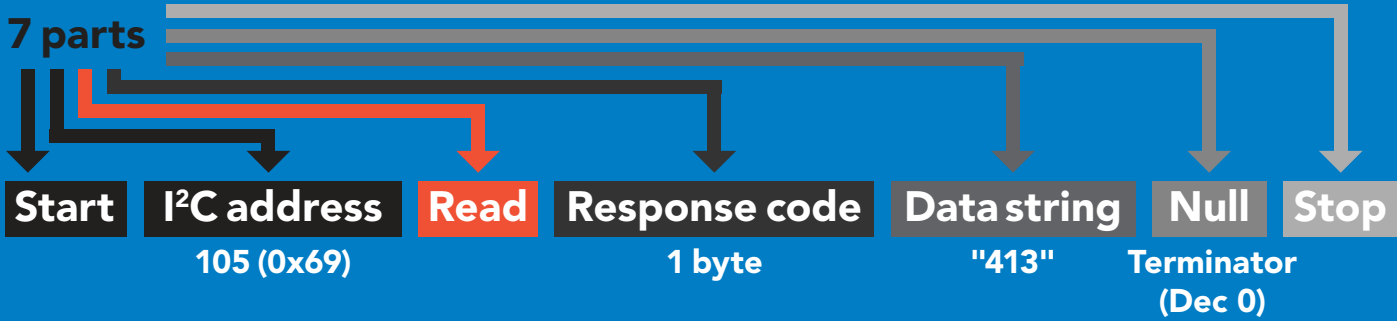

Advanced

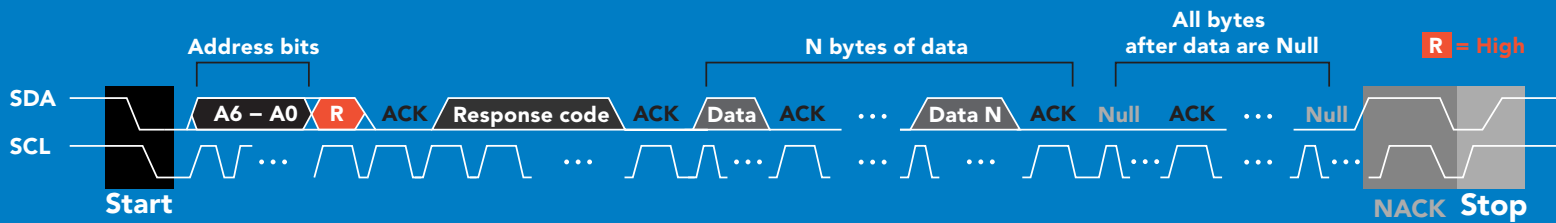

1 52 49 51 0 = 413

Dec ASCII Dec

Response codes & processing delay

After a command has been issued, a 1 byte response code can be read in order to confirm that the command was processed successfully.

Reading back the response code is completely optional, and is not required for normal operation.

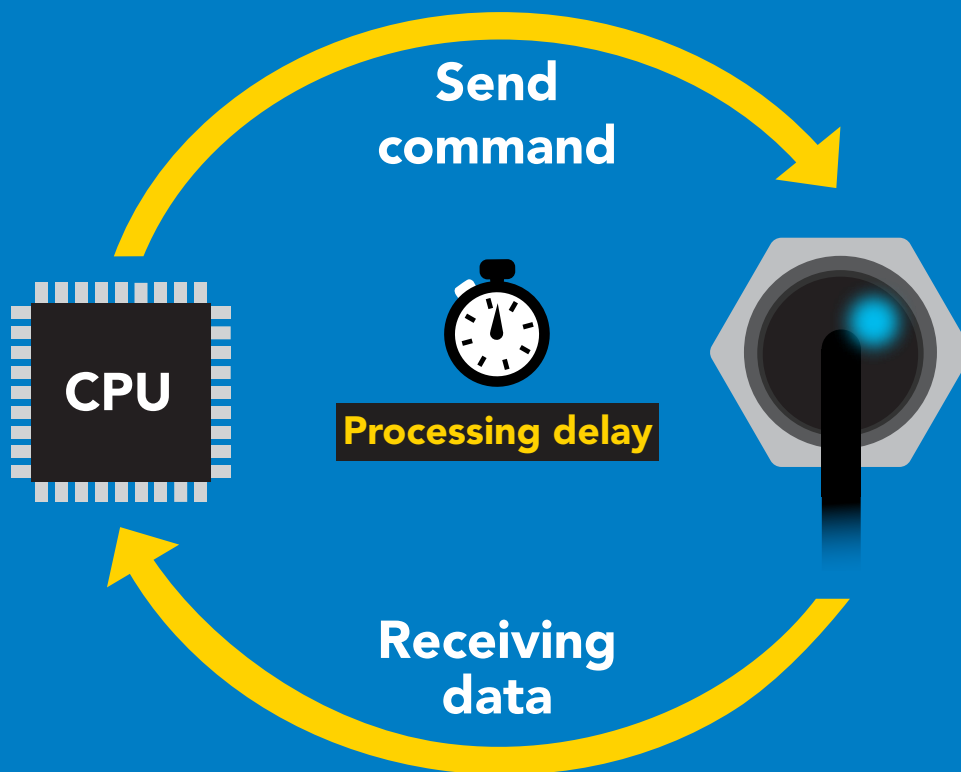

Example

```
I2C_start;  
I2C_address;  
I2C_write(EZO_command);  
I2C_stop;
```

```
delay(300);
```



```
Processing delay
```

```
I2C_start;  
I2C_address;  
Char[ ] = I2C_read;  
I2C_stop;
```

If there is no processing delay or the processing delay is too short, the response code will always be 254.

Response codes

Single byte, not string

255	no data to send
254	still processing, not ready
2	syntax error
1	successful request

LED color definition

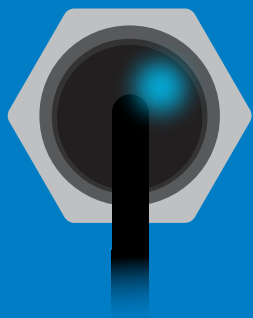

Blue

I²C standby



Green

Taking reading

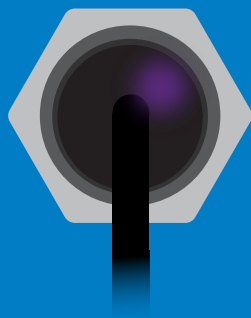

Purple

Changing
I²C address

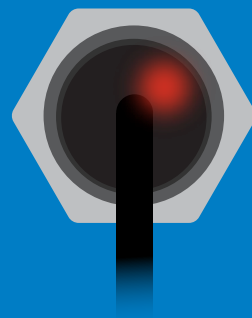

Red

Command
not understood

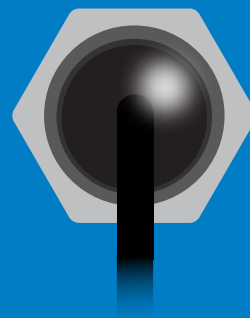

White

Find

5V	LED ON +2.5 mA
3.3V	+1 mA

I²C mode

command quick reference

All commands are ASCII strings or single ASCII characters.

Command	Function	
Alarm	enable/disable alarm	pg. 46
Baud	switch back to UART mode	pg. 56
Cal	performs custom calibration	pg. 47
Factory	enable factory reset	pg. 55
Find	finds device with blinking white LED	pg. 44
i	device information	pg. 50
I2C	change I ² C address	pg. 54
L	enable/disable LED	pg. 43
Name	set/show name of device	pg. 49
O	enable/disable internal temp	pg. 48
Plock	enable/disable protocol lock	pg. 57
R	returns a single reading	pg. 45
Sleep	enter sleep mode/low power	pg. 52
Status	retrieve status information	pg. 51

LED control

Command syntax

300ms  processing delay

- L,1 LED on **default**
- L,0 LED off
- L,? LED state on/off?

Example

Response

L,1

Wait 300ms

1	0
Dec	Null

L,0

Wait 300ms

1	0
Dec	Null

L,?



Wait 300ms

1	?L,1	0
Dec	ASCII	Null

or

Wait 300ms

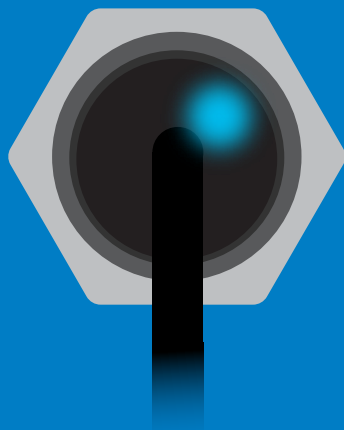
1	?L,0	0
Dec	ASCII	Null



L,1

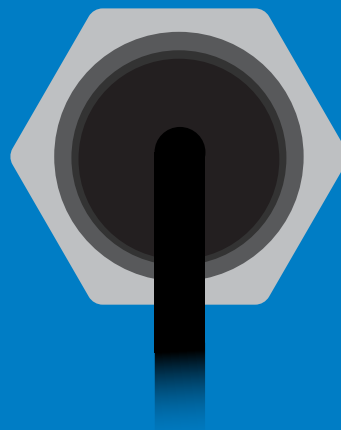

L,0

Find

300ms  processing delay

Command syntax

Find LED rapidly blinks white, used to help find device

Example

Response

Find

 Wait 300ms **1** Dec **0** Null

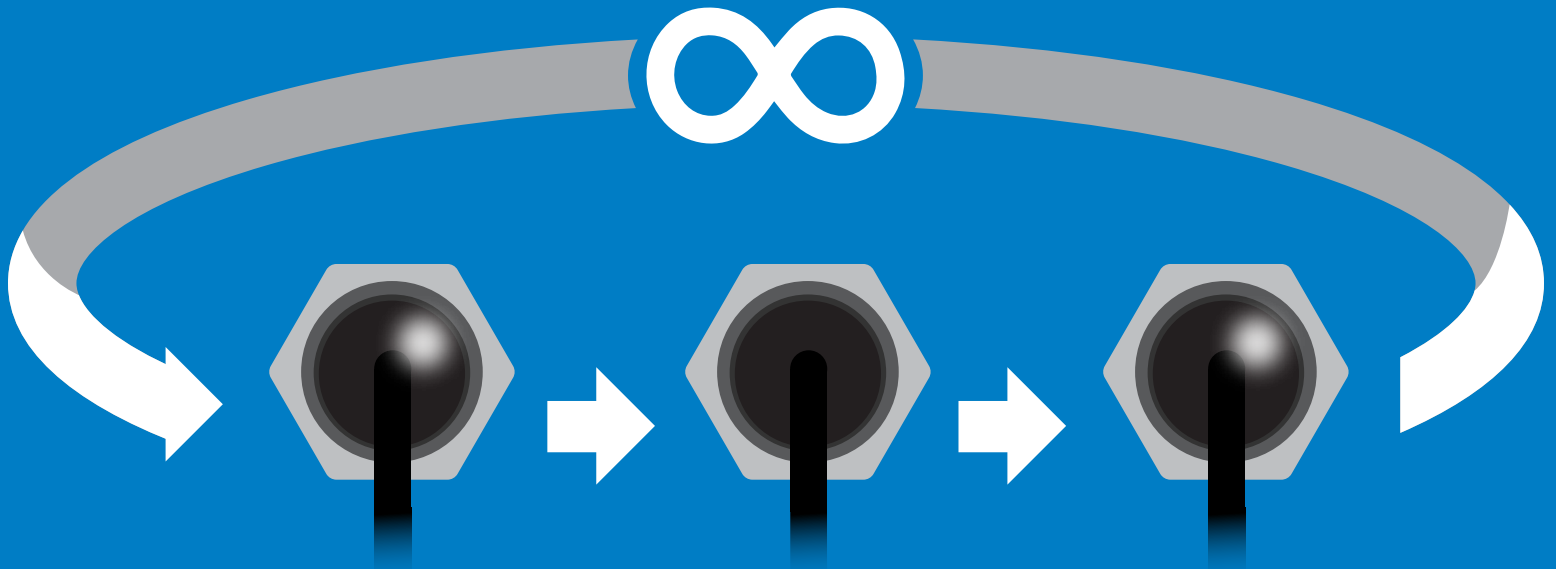

Taking reading

Command syntax

900ms  processing delay

R return 1 reading

Example

Response

R

 Wait 900ms **1** Dec **800** ASCII **0** Null

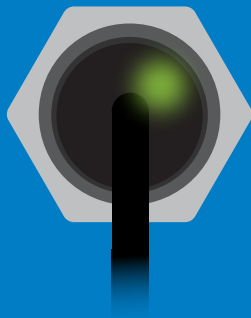

Green

Taking reading

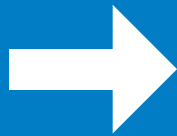

Wait 900ms

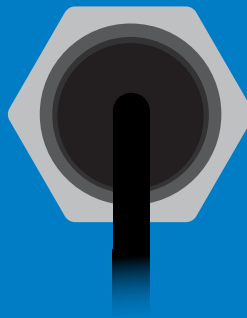

Transmitting

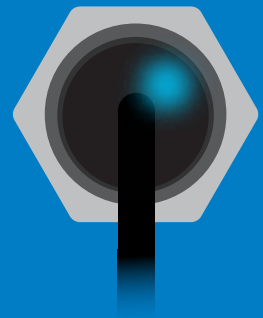
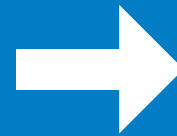

Cyan

Standby

Alarm

300ms  processing delay

Command syntax

The alarm pin will = 1 when CO2 levels are > alarm set point. Alarm tolerance sets how far below the set point CO2 levels need to drop before the pin will = 0 again.

- Alarm,en,[1,0] enable / disable alarm
- Alarm,n sets alarm
- Alarm,tol,n sets alarm tolerance (0 - 500 ppm)
- Alarm,? alarm set?

Example

Response

Alarm,en,1

 Wait 300ms **1** Dec **0** Null Enable alarm

Alarm,1200

 Wait 300ms **1** Dec **0** Null

Alarm,tol,100

 Wait 300ms **1** Dec **0** Null CO2 level must fall 100 ppm below set point for alarm to reset.

Alarm,?

 Wait 300ms **1** Dec **?,alarm,1200,100,1** ASCII **0** Null if all are enabled

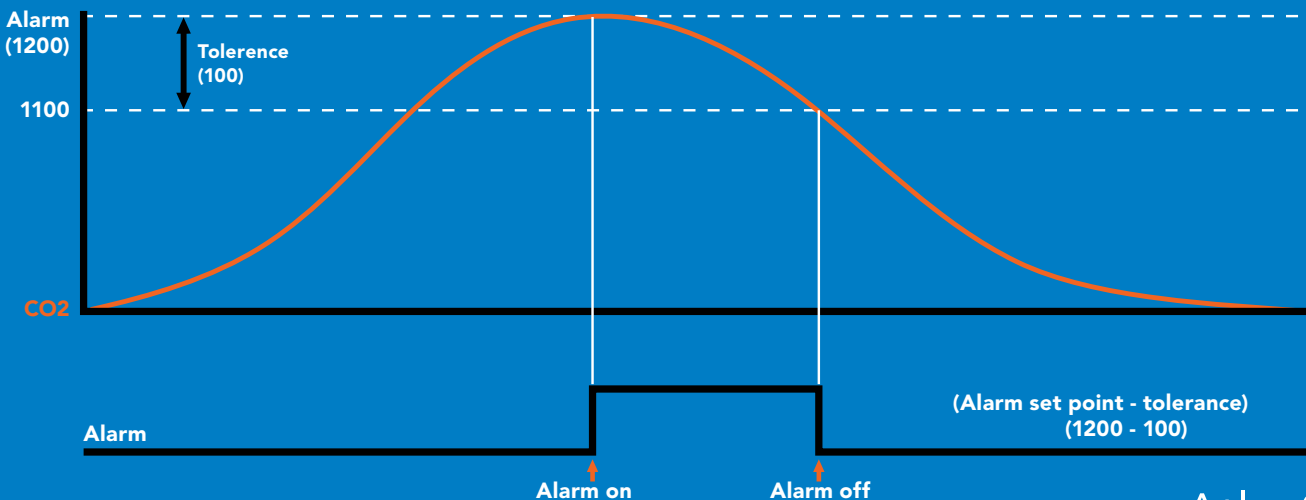

Custom calibration

900ms  processing delay

Command syntax

High point calibration can be from 3,000 ppm to 5,000 ppm. Calibration outside of that range may lead to accuracy issues.

Cal,n	calibrates the high point
Cal,0	calibrates the zero point
Cal,clear	restores calibration to factory settings
Cal,?	device calibrated?

Example

Response

Cal,3900

Wait 900ms 1 0
Dec Null

Cal,0

Wait 900ms 1 0
Dec Null

Cal,clear

Wait 300ms 1 0
Dec Null

Cal,?

Wait 300ms 1 ?Cal,0 0 or 1 ?Cal,1 0
Dec ASCII Null Dec ASCII Null
no calibration only zero point calibration

or 1 ?Cal,2 0 or 1 ?Cal,3 0
Dec ASCII Null Dec ASCII Null
only high point calibration zero and high point calibration

This device comes pre-calibrated.

Custom calibration should not be performed without scientific grade calibration gasses.

Enable/disable internal temperature from output string

Command syntax

300ms  processing delay

`O,t,[1,0]` enable or disable internal temperature

Example

Response

`O,t,1`

 **1** **0**
Wait 300ms Dec Null

enable temperature

`O,t,0`

 **1** **0**
Wait 300ms Dec Null

disable temperature

`O,?`

 **1** `?O,ppm,t` **0**
Wait 300ms Dec ASCII Null

if internal temp is enabled

Enabling the internal temperature should only be used to confirm that the device is at thermal equilibrium. Refer to page 6

Naming device

300ms  processing delay

Command syntax

Do not use spaces in the name

Name,n	set name	n =	1	2	3	4	5	6	7	8	9	10	11	12	13	14	15	16
Name,	clears name		Up to 16 ASCII characters															
Name,?	show name																	

Example

Response

Name,



1 0
Dec Null

name has been cleared

Name,zzt



1 0
Dec Null

Name,?



1 ?Name,zzt 0
Dec ASCII Null

Name,zzt

Name,?

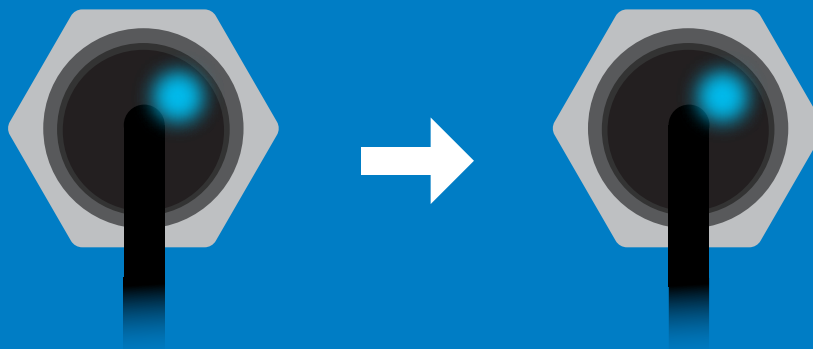

1 0

1 ?Name,zzt 0

Device information

Command syntax

300ms  processing delay

i device information

Example

Response

i



Wait 300ms

1

Dec

?i,CO2,1.00

ASCII

0

Null

Response breakdown

?i, CO2, 1.00
↑ ↑
Device Firmware

Reading device status

Command syntax

300ms  processing delay

Status voltage at Vcc pin and reason for last restart

Example

Response

Status

 **1** **?Status,P,5.038** **0**
Wait 300ms Dec ASCII Null

Response breakdown

?Status, **P,** **5.038**
Reason for restart Voltage at Vcc

Restart codes

P powered off
S software reset
B brown out
W watchdog
U unknown

Sleep mode/low power

Command syntax

Sleep enter sleep mode/low power

Send any character or command to awaken device.

Example

Response

Sleep

no response

Do not read status byte after issuing sleep command.

Any command

wakes up device

5V	STANDBY 45 mA	SLEEP 3.4 mA
3.3V	42 mA	3.0 mA



Standby

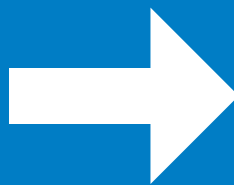

Sleep

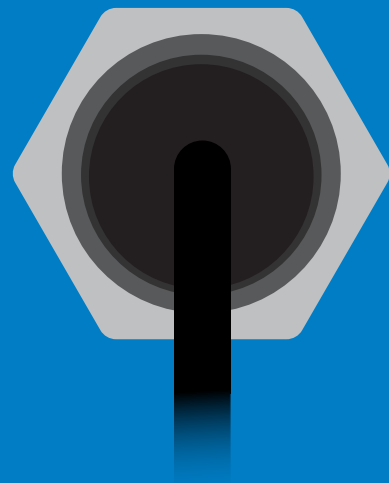

Sleep

Protocol lock

Command syntax

300ms  processing delay

Plock,1 enable Plock

Plock,0 disable Plock

Plock,? Plock on/off?

Locks device to I²C mode.

default

Example

Response

Plock,1

 Wait 300ms
1 0
Dec Null

Plock,0

 Wait 300ms
1 0
Dec Null

Plock,?

 Wait 300ms
1 ?Plock,1 0
Dec ASCII Null

Plock,1

Baud, 9600

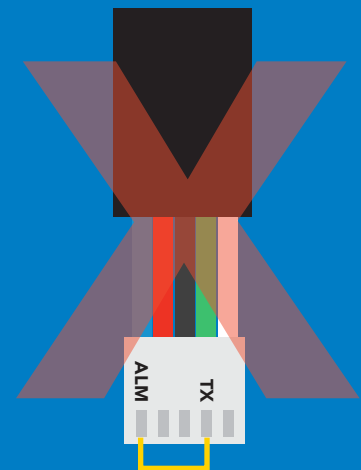
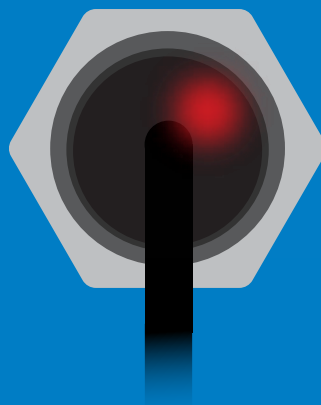
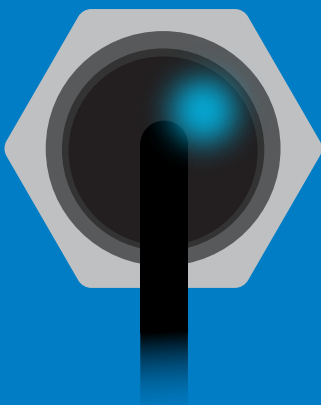

cannot change to UART

cannot change to UART

I²C address change

Command syntax

300ms  processing delay

I2C,n sets I²C address and reboots into I²C mode

Example

Response

I2C,101

device reboot
(no response given)

Warning!

Changing the I²C address will prevent communication between the circuit and the CPU until the CPU is updated with the new I²C address.

Default I²C address is 105 (0x69).

n = any number 1 – 127

I2C,101

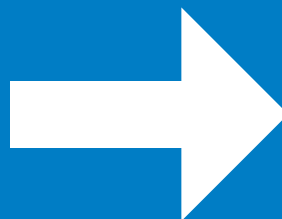

(reboot)



Factory reset

Command syntax

Factory reset will not take the device out of I²C mode.

Factory enable factory reset

I²C address will not change

Example

Response

Factory

device reboot
(no response given)

Clears custom calibration
LED on
Response codes enabled

Factory

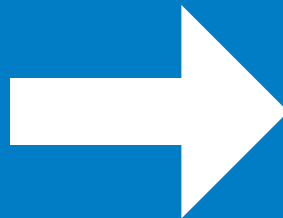
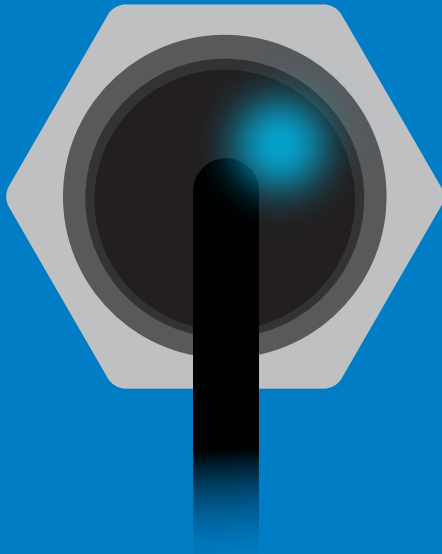

(reboot)

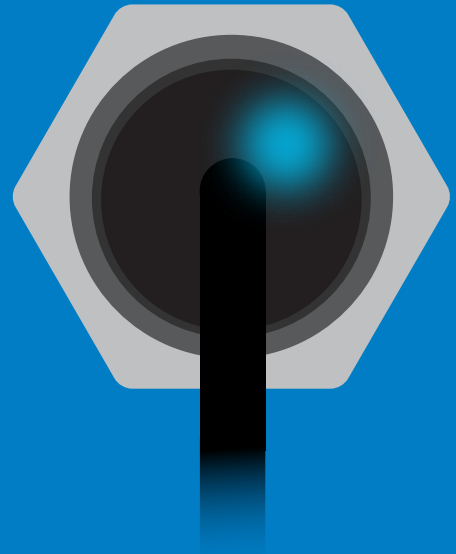

Change to UART mode

Command syntax

Baud,n switch from I²C to UART

Example

Baud,9600

Response

reboot in UART mode
(no response given)

n = [300
1200
2400
9600
19200
38400
57600
115200

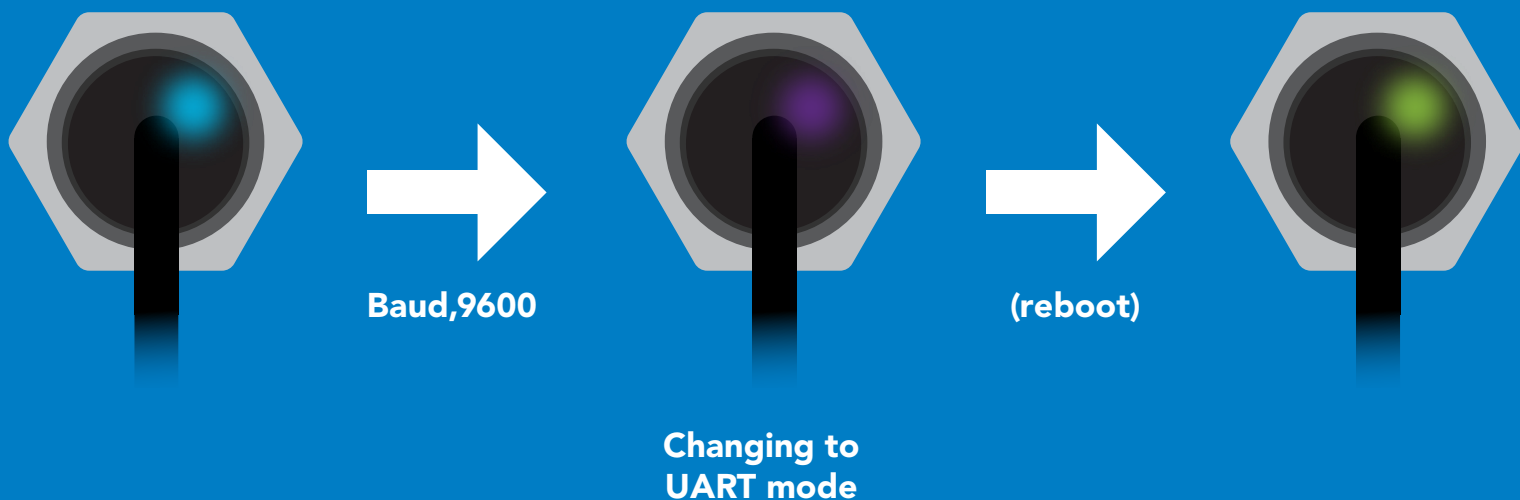

Manual switching to UART

- Disconnect ground (power off)
- Disconnect TX and RX
- Connect TX to ALM
- Confirm RX is disconnected
- Connect ground (power on)
- Wait for LED to change from Blue to Green
- Disconnect ground (power off)
- Reconnect all data and power

Example

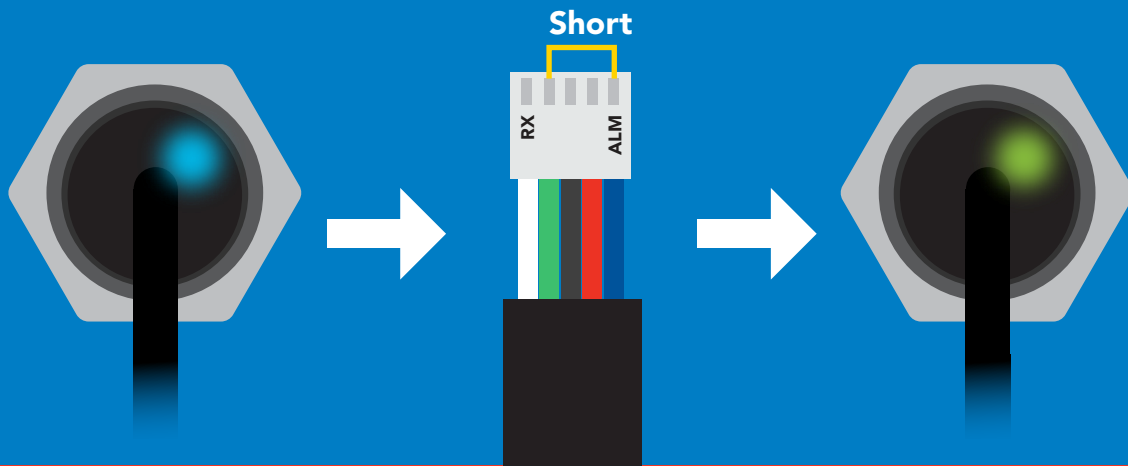

Wrong Example

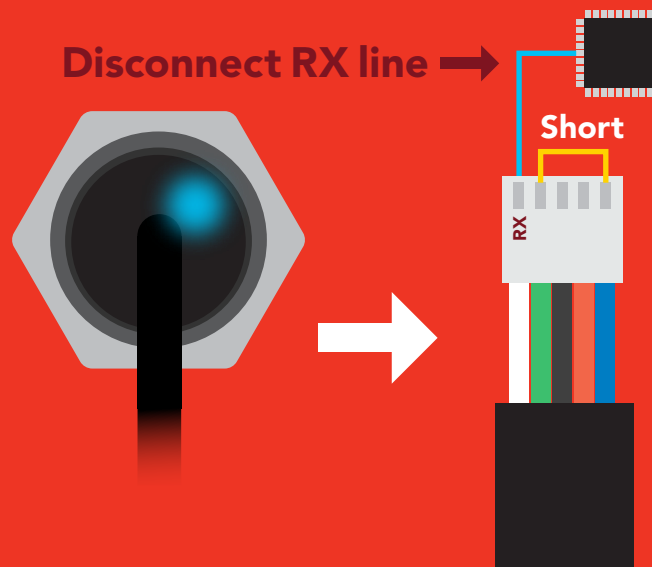

Datasheet change log

Datasheet V 2.0

Revised "Attention" information on page 5.

Datasheet V 1.9

Revised info on the cover page

Datasheet V 1.8

Revised accuracy listed on cover page.

Datasheet V 1.7

Removed Import/Export commands from datasheet.

Datasheet V 1.6

Revised naming device info on pages 28 & 53.

Datasheet V 1.5

Revised info for "Pin out" on page 8.

Datasheet V 1.4

Added life expectancy to the cover page, and moved Default state to pg 11.

Datasheet V 1.3

Added page about pointing the CO2 sensor at bright lights on pg 4.

Datasheet V 1.2

Revised response for the sleep command in UART mode on pg 29.

Datasheet V 1.1

Added more information on the Export calibration and Import calibration commands.

Datasheet V 1.0

New datasheet

Firmware updates

V1.00 – (Sept 12, 2018)

- Initial release

V2.00 – (Jan 24, 2020)

- Changes the lamp power supply to 5V with boost converter, stops CO2 readings from going below 0.

V2.01 – (Nov 06, 2020)

- Adjusts lamp frequency to fit the lamp signal into the ADC range more consistently.

Warranty

Atlas Scientific™ Warranties the EZO-CO2™ Embedded NDIR CO2 Sensor to be free of defect during the debugging phase of device implementation, or 30 days after receiving the EZO-CO2™ Embedded NDIR CO2 Sensor (which ever comes first).

The debugging phase

The debugging phase as defined by Atlas Scientific™ is the time period when the EZO-CO2™ Embedded NDIR CO2 Sensor is connected into a bread board, or shield. If the EZO-CO2™ Embedded NDIR CO2 Sensor is being debugged in a bread board, the bread board must be devoid of other components. If the EZO-CO2™ Embedded NDIR CO2 Sensor is being connected to a microcontroller, the microcontroller must be running code that has been designed to drive the EZO-CO2™ Embedded NDIR CO2 Sensor exclusively and output the EZO-CO2™ Embedded NDIR CO2 Sensor data as a serial string.

It is important for the embedded systems engineer to keep in mind that the following activities will void the EZO-CO2™ Embedded NDIR CO2 Sensor warranty:

- Soldering any part to the EZO-CO2™ Embedded NDIR CO2 Sensor.
- Running any code, that does not exclusively drive the EZO-CO2™ Embedded NDIR CO2 Sensor and output its data in a serial string.
- Embedding the EZO-CO2™ Embedded NDIR CO2 Sensor into a custom made device.
- Removing any potting compound.

Reasoning behind this warranty

Because Atlas Scientific™ does not sell consumer electronics; once the device has been embedded into a custom made system, Atlas Scientific™ cannot possibly warranty the EZO-CO2™ Embedded NDIR CO2 Sensor, against the thousands of possible variables that may cause the EZO-CO2™ Embedded NDIR CO2 Sensor to no longer function properly.

Please keep this in mind:

- 1. All Atlas Scientific™ devices have been designed to be embedded into a custom made system by you, the embedded systems engineer.**
- 2. All Atlas Scientific™ devices have been designed to run indefinitely without failure in the field.**
- 3. All Atlas Scientific™ devices can be soldered into place, however you do so at your own risk.**

Atlas Scientific™ is simply stating that once the device is being used in your application, Atlas Scientific™ can no longer take responsibility for the EZO-CO2™ Embedded NDIR CO2 Sensor continued operation. This is because that would be equivalent to Atlas Scientific™ taking responsibility over the correct operation of your entire device.