

National Semiconductor is now part of
Texas Instruments.

Search <http://www.ti.com/> for the latest technical
information and details on our current products and services.

LMP2011 Single/LMP2012 Dual High Precision, Rail-to-Rail Output Operational Amplifier

General Description

The LMP201x series are the first members of National's new LMP™ precision amplifier family. The LMP201X series offers unprecedented accuracy and stability in space-saving miniature packaging while also being offered at an affordable price. This device utilizes patented techniques to measure and continually correct the input offset error voltage. The result is an amplifier which is ultra stable over time and temperature. It has excellent CMRR and PSRR ratings, and does not exhibit the familiar 1/f voltage and current noise increase that plagues traditional amplifiers. The combination of the LMP201X characteristics makes it a good choice for transducer amplifiers, high gain configurations, ADC buffer amplifiers, DAC I-V conversion, and any other 2.7V-5V application requiring precision and long term stability.

Other useful benefits of the LMP201X are rail-to-rail output, a low supply current of 930 μ A, and wide gain-bandwidth product of 3 MHz. These extremely versatile features found in the LMP201X provide high performance and ease of use.

Features

(For $V_S = 5V$, Typical unless otherwise noted)

- Low guaranteed V_{OS} over temperature 60 μ V
- Low noise with no 1/f 35nV/ \sqrt{Hz}
- High CMRR 130 dB
- High PSRR 120 dB
- High A_{VOL} 130 dB
- Wide gain-bandwidth product 3MHz
- High slew rate 4V/ μ s
- Low supply current 930 μ A
- Rail-to-rail output 30mV
- No external capacitors required

Applications

- Precision instrumentation amplifiers
- Thermocouple amplifiers
- Strain gauge bridge amplifier

Connection Diagrams

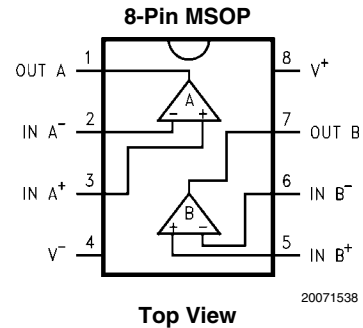
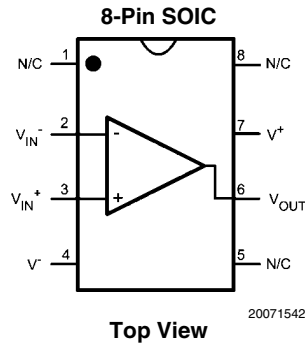
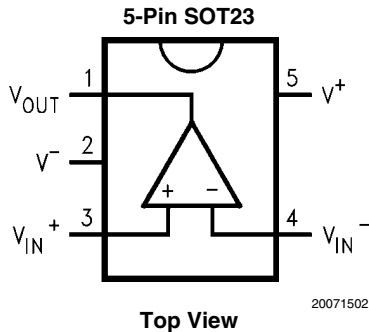

Ordering Information

Package	Part Number	Temperature Range	Package Marking	Transport Media	NSC Drawing
5-Pin SOT23	LMP2011MF	-40°C to 125°C	AN1A	1k Units Tape and Reel	MF05A
	LMP2011MFX			3k Units Tape and Reel	
8-Pin MSOP	LMP2012MM		AP1A	1k Units Tape and Reel	MUA08A
	LMP2012MMX			3.5k Units Tape and Reel	
8-Pin SOIC	LMP2011MA		LMP2011MA	95 Units/Rail	M08A
	LMP2011MAX			2.5k Units Tape and Reel	
	LMP2012MA	95 Units/Rail			
	LMP2012MAX	2.5k Units Tape and Reel			

Absolute Maximum Ratings (Note 1)

If Military/Aerospace specified devices are required, please contact the National Semiconductor Sales Office/Distributors for availability and specifications.

ESD Tolerance	
Human Body Model	2000V
Machine Model	200V
Supply Voltage	5.8V
Common-Mode Input Voltage	$-0.3 \leq V_{CM} \leq V_{CC} + 0.3V$
Lead Temperature (soldering 10 sec.)	+300°C

Differential Input Voltage	±Supply Voltage
Current at Input Pin	30 mA
Current at Output Pin	30 mA
Current at Power Supply Pin	50 mA

Operating Ratings (Note 1)

Supply Voltage	2.7V to 5.25V
Storage Temperature Range	-65°C to 150°C
Operating Temperature Range	-40°C to 125°C

2.7V DC Electrical Characteristics

Unless otherwise specified, all limits guaranteed for $T_J = 25^\circ\text{C}$, $V^+ = 2.7V$, $V^- = 0V$, $V_{CM} = 1.35V$, $V_O = 1.35V$ and $R_L > 1\text{ M}\Omega$. **Boldface** limits apply at the temperature extremes.

Symbol	Parameter	Conditions	Min (Note 3)	Typ (Note 2)	Max (Note 3)	Units
V_{OS}	Input Offset Voltage (LMP2011 only)			0.8	25 60	μV
	Input Offset Voltage (LMP2012 only)			0.8	36 60	
	Offset Calibration Time			0.5	10 12	ms
TCV_{OS}	Input Offset Voltage			0.015		$\mu\text{V}/^\circ\text{C}$
	Long-Term Offset Drift			0.006		$\mu\text{V}/\text{month}$
	Lifetime V_{OS} Drift			2.5		μV
I_{IN}	Input Current			-3		pA
I_{OS}	Input Offset Current			6		pA
R_{IND}	Input Differential Resistance			9		$\text{M}\Omega$
CMRR	Common Mode Rejection Ratio	$-0.3 \leq V_{CM} \leq 0.9V$	95	130		dB
		$0 \leq V_{CM} \leq 0.9V$	90			
PSRR	Power Supply Rejection Ratio		95 90	120		dB
A_{VOL}	Open Loop Voltage Gain	$R_L = 10\text{ k}\Omega$	95 90	130		dB
		$R_L = 2\text{ k}\Omega$	90 85	124		
V_O	Output Swing (LMP2011 only)	$R_L = 10\text{ k}\Omega$ to 1.35V $V_{IN}(\text{diff}) = \pm 0.5V$	2.665 2.655	2.68		V
				0.033	0.060 0.075	
	Output Swing (LMP2011 only)	$R_L = 2\text{ k}\Omega$ to 1.35V $V_{IN}(\text{diff}) = \pm 0.5V$	2.630 2.615	2.65		V
				0.061	0.085 0.105	
	Output Swing (LMP2012 only)	$R_L = 10\text{ k}\Omega$ to 1.35V $V_{IN}(\text{diff}) = \pm 0.5V$	2.64 2.63	2.68		V
				0.033	0.060 0.075	
Output Swing (LMP2012 only)	$R_L = 2\text{ k}\Omega$ to 1.35V $V_{IN}(\text{diff}) = \pm 0.5V$	2.615 2.6	2.65		V	
			0.061	0.085 0.105		

Symbol	Parameter	Conditions	Min (Note 3)	Typ (Note 2)	Max (Note 3)	Units
I_O	Output Current	Sourcing, $V_O = 0V$ $V_{IN(diff)} = \pm 0.5V$	5 3	12		mA
		Sinking, $V_O = 5V$ $V_{IN(diff)} = \pm 0.5V$	5 3	18		
I_S	Supply Current per Channel			0.919	1.20 1.50	mA

2.7V AC Electrical Characteristics

$T_J = 25^\circ C$, $V^+ = 2.7V$, $V^- = 0V$, $V_{CM} = 1.35V$, $V_O = 1.35V$, and $R_L > 1 M\Omega$. **Boldface** limits apply at the temperature extremes.

Symbol	Parameter	Conditions	Min (Note 3)	Typ (Note 2)	Max (Note 3)	Units
GBW	Gain-Bandwidth Product			3		MHz
SR	Slew Rate			4		V/ μs
θ_m	Phase Margin			60		Deg
G_m	Gain Margin			-14		dB
e_n	Input-Referred Voltage Noise			35		nV/ \sqrt{Hz}
i_n	Input-Referred Current Noise					pA/ \sqrt{Hz}
$e_{n,p-p}$	Input-Referred Voltage Noise	$R_S = 100\Omega$, DC to 10 Hz		850		nV _{pp}
t_{rec}	Input Overload Recovery Time			50		ms

5V DC Electrical Characteristics

Unless otherwise specified, all limits guaranteed for $T_J = 25^\circ C$, $V^+ = 5V$, $V^- = 0V$, $V_{CM} = 2.5V$, $V_O = 2.5V$ and $R_L > 1M\Omega$. **Boldface** limits apply at the temperature extremes.

Symbol	Parameter	Conditions	Min (Note 3)	Typ (Note 2)	Max (Note 3)	Units
V_{OS}	Input Offset Voltage (LMP2011 only)			0.12	25 60	μV
	Input Offset Voltage (LMP2012 only)			0.12	36 60	
	Offset Calibration Time			0.5	10 12	ms
TCV_{OS}	Input Offset Voltage			0.015		$\mu V/^\circ C$
	Long-Term Offset Drift			0.006		$\mu V/month$
	Lifetime V_{OS} Drift			2.5		μV
I_{IN}	Input Current			-3		pA
I_{OS}	Input Offset Current			6		pA
R_{IND}	Input Differential Resistance			9		M Ω
CMRR	Common Mode Rejection Ratio	$-0.3 \leq V_{CM} \leq 3.2$	100 90	130		dB
		$0 \leq V_{CM} \leq 3.2$				
PSRR	Power Supply Rejection Ratio		95 90	120		dB
A_{VOL}	Open Loop Voltage Gain	$R_L = 10 k\Omega$	105 100	130		dB
		$R_L = 2 k\Omega$	95 90	132		

Symbol	Parameter	Conditions	Min (Note 3)	Typ (Note 2)	Max (Note 3)	Units
V_O	Output Swing (LMP2011 only)	$R_L = 10\text{ k}\Omega$ to 2.5V $V_{IN}(\text{diff}) = \pm 0.5\text{V}$	4.96 4.95	4.978		V
				0.040	0.070 0.085	
		$R_L = 2\text{ k}\Omega$ to 2.5V $V_{IN}(\text{diff}) = \pm 0.5\text{V}$	4.895 4.875	4.919		V
				0.091	0.115 0.140	
	Output Swing (LMP2012 only)	$R_L = 10\text{ k}\Omega$ to 2.5V $V_{IN}(\text{diff}) = \pm 0.5\text{V}$	4.92 4.91	4.978		V
				0.040	0.080 0.095	
	$R_L = 2\text{ k}\Omega$ to 2.5V $V_{IN}(\text{diff}) = \pm 0.5\text{V}$	4.875 4.855	4.919		V	
			0.091	0.125 0.150		
I_O	Output Current	Sourcing, $V_O = 0\text{V}$ $V_{IN}(\text{diff}) = \pm 0.5\text{V}$	8 6	15		mA
		Sinking, $V_O = 5\text{V}$ $V_{IN}(\text{diff}) = \pm 0.5\text{V}$	8 6	17		
I_S	Supply Current per Channel			0.930	1.20 1.50	mA

5V AC Electrical Characteristics $T_J = 25^\circ\text{C}$, $V^+ = 5\text{V}$, $V^- = 0\text{V}$, $V_{CM} = 2.5\text{V}$, $V_O = 2.5\text{V}$, and $R_L > 1\text{M}\Omega$.
Boldface limits apply at the temperature extremes.

Symbol	Parameter	Conditions	Min (Note 3)	Typ (Note 2)	Max (Note 3)	Units
GBW	Gain-Bandwidth Product			3		MHz
SR	Slew Rate			4		V/ μs
θ_m	Phase Margin			60		deg
G_m	Gain Margin			-15		dB
e_n	Input-Referred Voltage Noise			35		$\text{nV}/\sqrt{\text{Hz}}$
i_n	Input-Referred Current Noise					$\text{pA}/\sqrt{\text{Hz}}$
$e_{n,p-p}$	Input-Referred Voltage Noise	$R_S = 100\Omega$, DC to 10 Hz		850		nV_{pp}
t_{rec}	Input Overload Recovery Time			50		ms

Note 1: Absolute Maximum Ratings indicate limits beyond which damage may occur. Operating Ratings indicate conditions for which the device is intended to be functional, but specific performance is not guaranteed. For guaranteed specifications and test conditions, see the Electrical Characteristics.

Note 2: Typical values represent the most likely parametric norm.

Note 3: Limits are 100% production tested at 25°C. Limits over the operating temperature range are guaranteed through correlations using statistical quality control (SQC) method.

Typical Performance Characteristics $T_A=25^\circ\text{C}$, $V_S=5\text{V}$ unless otherwise specified.

Supply Current vs. Supply Voltage

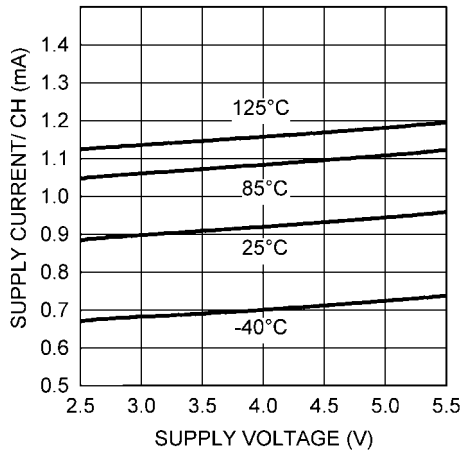

20071555

Offset Voltage vs. Supply Voltage

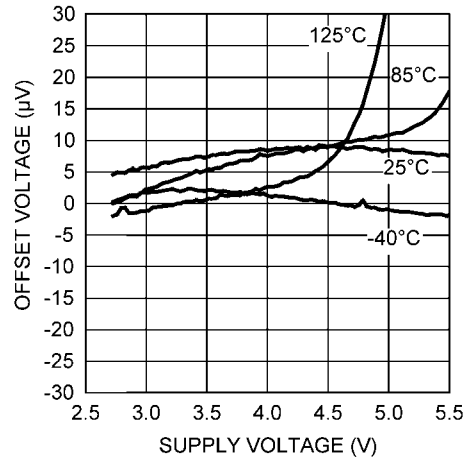

20071556

Offset Voltage vs. Common Mode

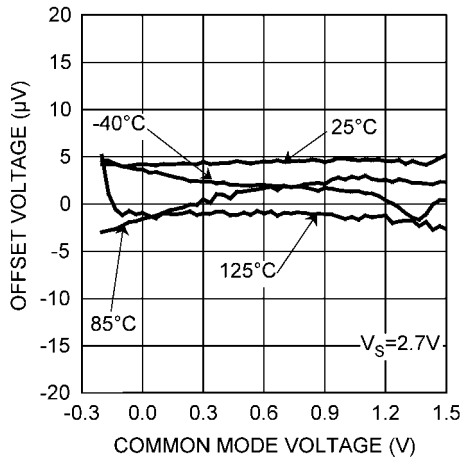

20071557

Offset Voltage vs. Common Mode

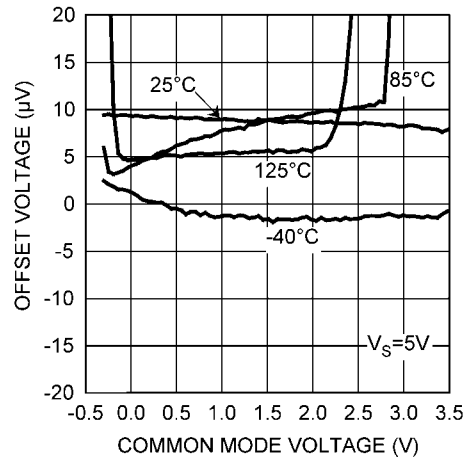

20071558

Voltage Noise vs. Frequency

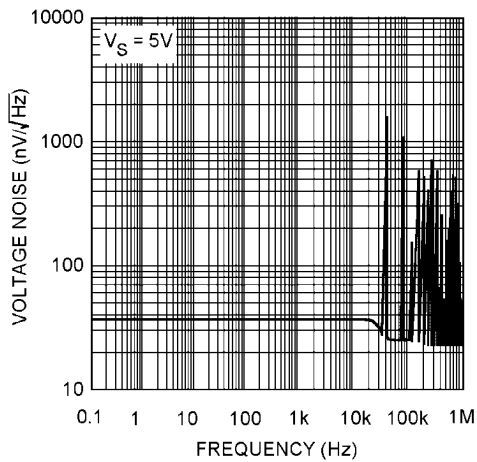

20071504

Input Bias Current vs. Common Mode

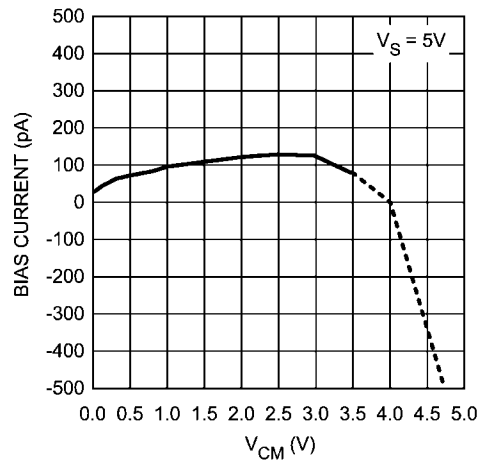

20071503

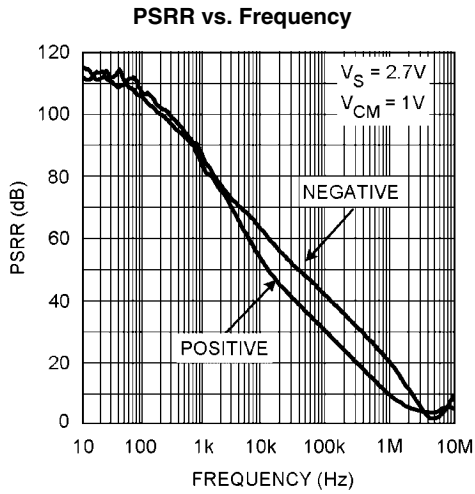

20071507

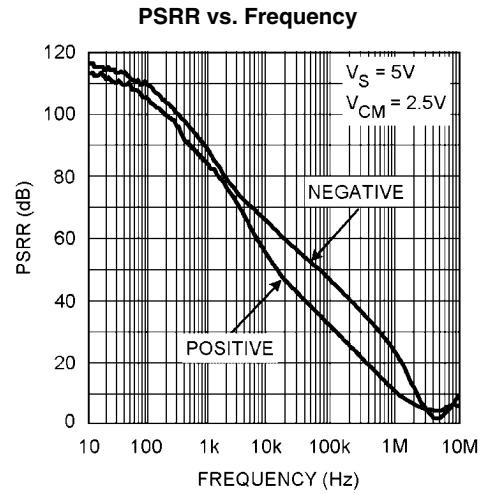

20071506

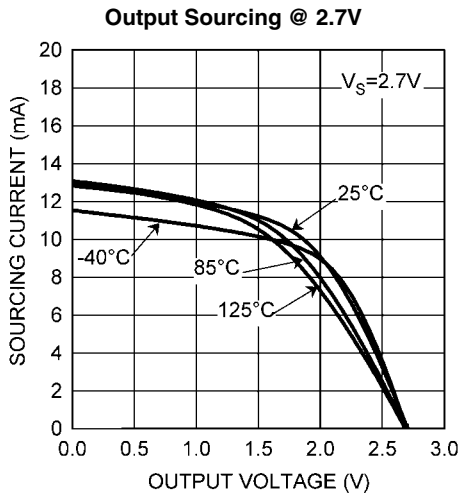

20071559

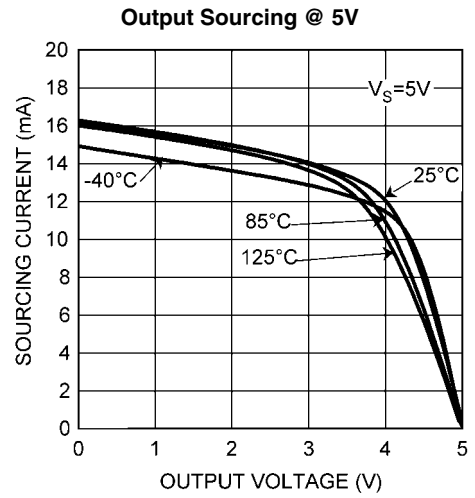

20071560

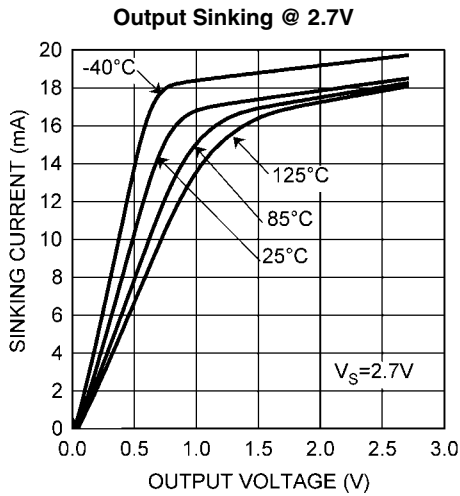

20071561

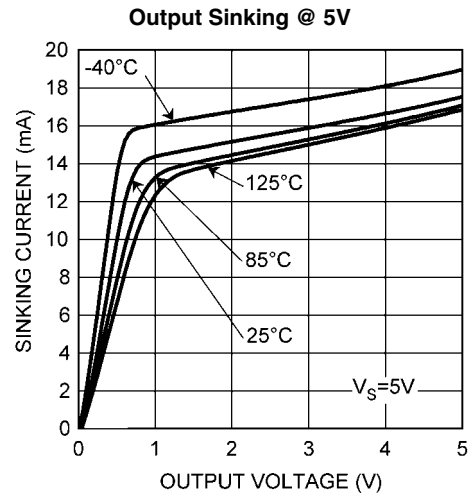

20071562

Max Output Swing vs. Supply Voltage

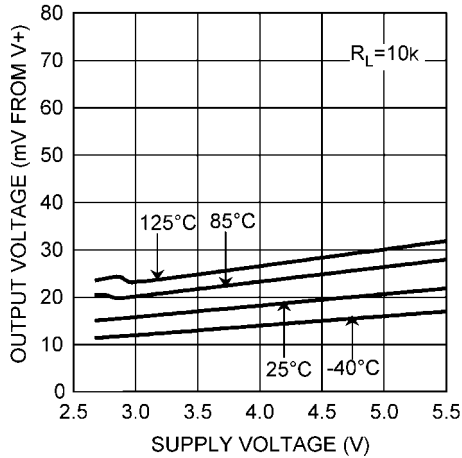

Max Output Swing vs. Supply Voltage

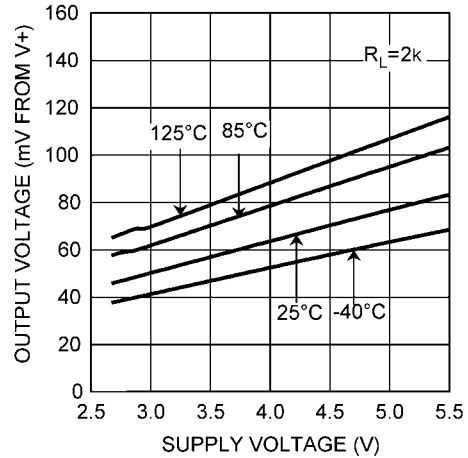

Min Output Swing vs. Supply Voltage

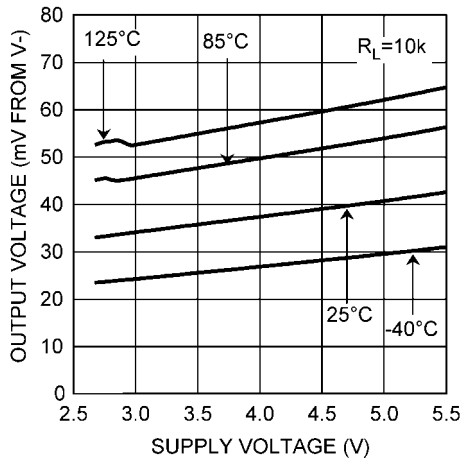

Min Output Swing vs. Supply Voltage

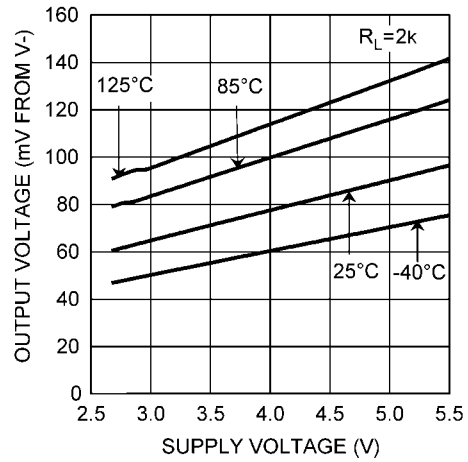

CMRR vs. Frequency

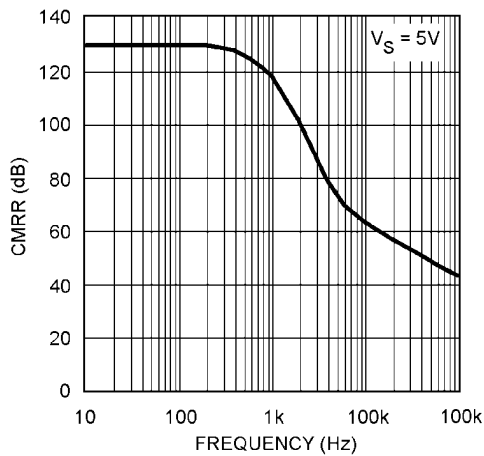

Open Loop Gain and Phase vs. Supply Voltage

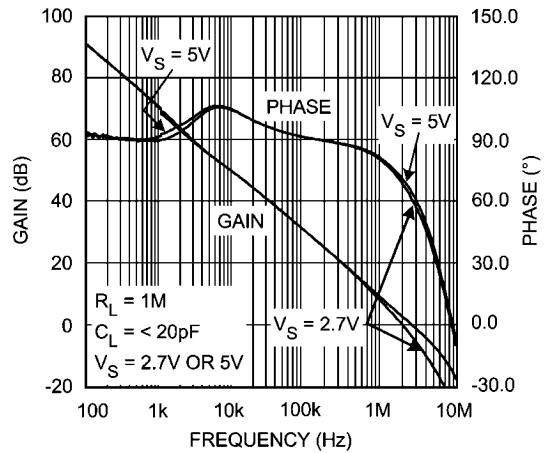

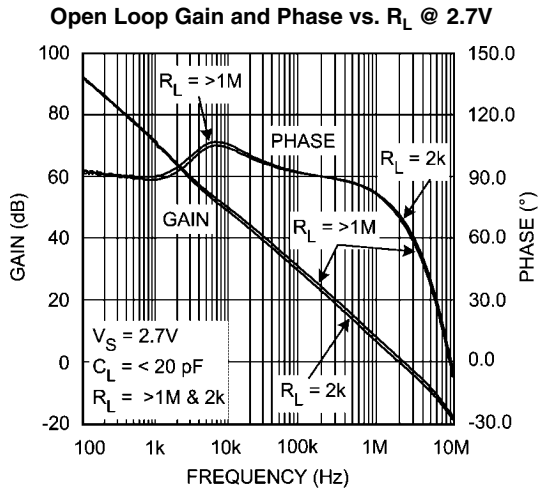

20071509

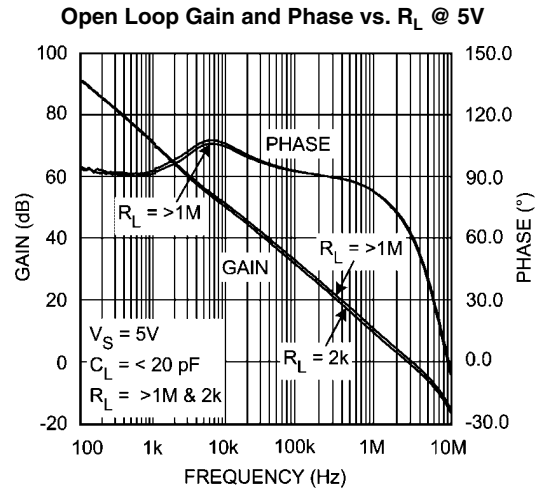

20071510

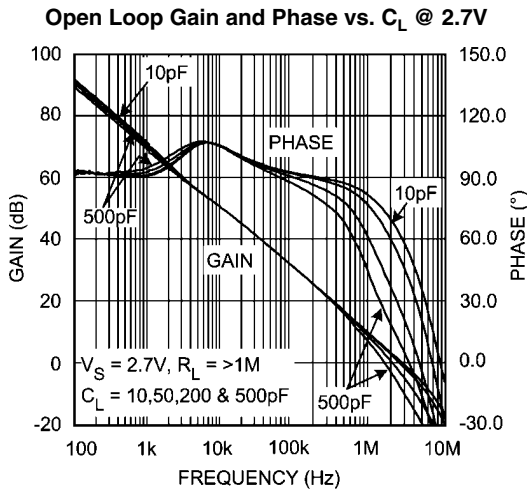

20071511

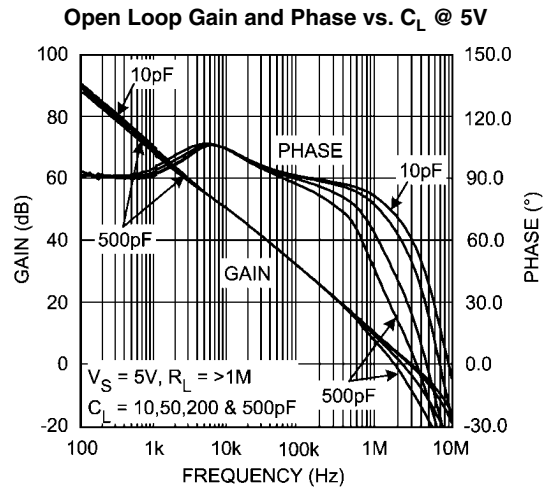

20071512

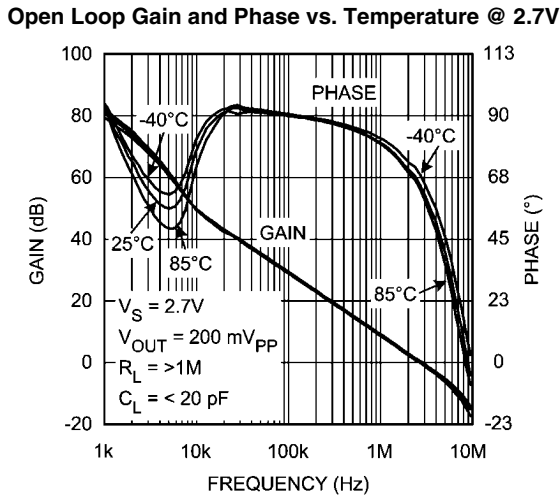

20071536

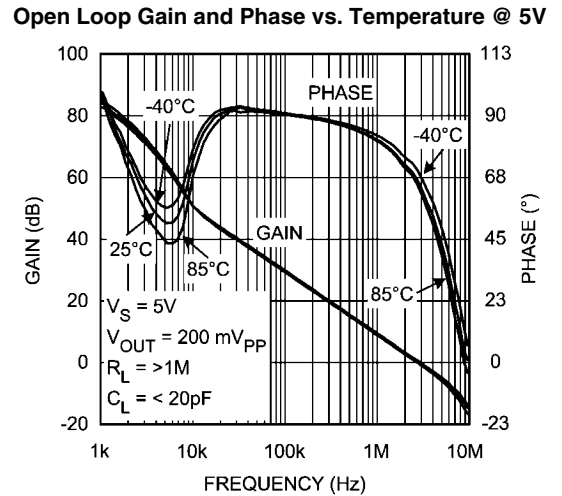

20071537

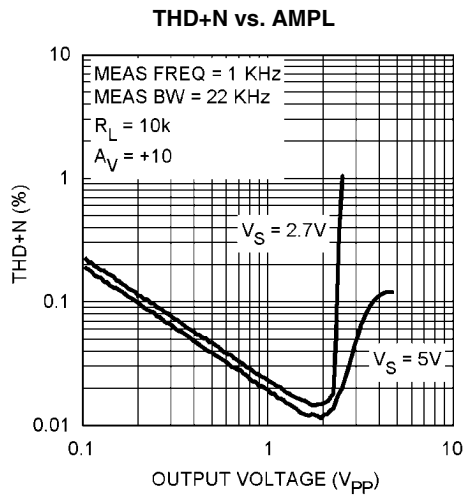

20071514

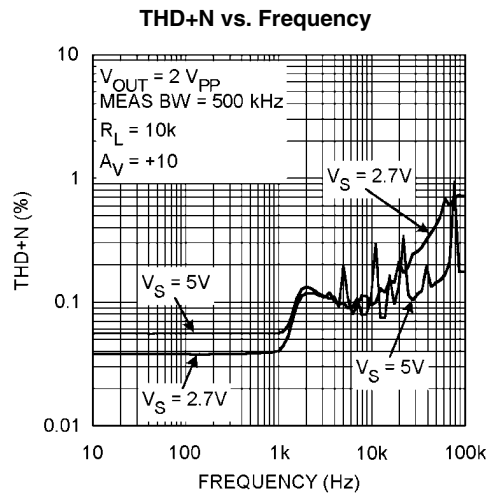

20071513

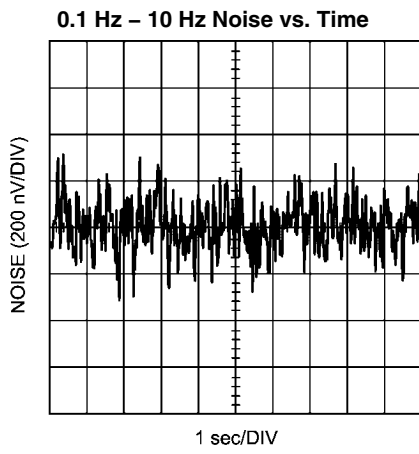

20071515

Application Information

THE BENEFITS OF LMP201X NO 1/f NOISE

Using patented methods, the LMP201X eliminates the 1/f noise present in other amplifiers. That noise, which increases as frequency decreases, is a major source of measurement error in all DC-coupled measurements. Low-frequency noise appears as a constantly-changing signal in series with any measurement being made. As a result, even when the measurement is made rapidly, this constantly-changing noise signal will corrupt the result. The value of this noise signal can be surprisingly large. For example: If a conventional amplifier has a flat-band noise level of $10\text{ nV}/\sqrt{\text{Hz}}$ and a noise corner of 10 Hz, the RMS noise at 0.001 Hz is $1\text{ }\mu\text{V}/\sqrt{\text{Hz}}$. This is equivalent to a 0.50 μV peak-to-peak error, in the frequency range 0.001 Hz to 1.0 Hz. In a circuit with a gain of 1000, this produces a 0.50 mV peak-to-peak output error. This number of 0.001 Hz might appear unreasonably low, but when a data acquisition system is operating for 17 minutes, it has been on long enough to include this error. In this same time, the LMP201X will only have a 0.21 mV output error. This is smaller by 2.4 x. Keep in mind that this 1/f error gets even larger at lower frequencies. At the extreme, many people try to reduce this error by integrating or taking several samples of the same signal. This is also doomed to failure because the 1/f nature of this noise means that taking longer samples just moves the measurement into lower frequencies where the noise level is even higher.

The LMP201X eliminates this source of error. The noise level is constant with frequency so that reducing the bandwidth reduces the errors caused by noise.

Another source of error that is rarely mentioned is the error voltage caused by the inadvertent thermocouples created when the common "Kovar type" IC package lead materials are soldered to a copper printed circuit board. These steel-based leadframe materials can produce over $35\text{ }\mu\text{V}/^\circ\text{C}$ when soldered onto a copper trace. This can result in thermocouple noise that is equal to the LMP201X noise when there is a temperature difference of only 0.0014°C between the lead and the board!

For this reason, the lead-frame of the LMP201X is made of copper. This results in equal and opposite junctions which cancel this effect. The extremely small size of the SOT-23 package results in the leads being very close together. This further reduces the probability of temperature differences and hence decreases thermal noise.

OVERLOAD RECOVERY

The LMP201X recovers from input overload much faster than most chopper-stabilized op amps. Recovery from driving the amplifier to 2X the full scale output, only requires about 40 ms. Many chopper-stabilized amplifiers will take from 250 ms to several seconds to recover from this same overload. This is because large capacitors are used to store the unadjusted offset voltage.

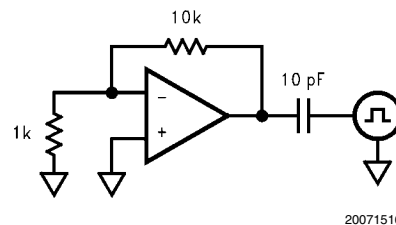

20071516

FIGURE 1. Overload Recovery Test

The wide bandwidth of the LMP201X enhances performance when it is used as an amplifier to drive loads that inject transients back into the output. ADCs (Analog-to-Digital Converters) and multiplexers are examples of this type of load. To simulate this type of load, a pulse generator producing a 1V peak square wave was connected to the output through a 10 pF capacitor. (Figure 1) The typical time for the output to recover to 1% of the applied pulse is 80 ns. To recover to 0.1% requires 860ns. This rapid recovery is due to the wide bandwidth of the output stage and large total GBW.

NO EXTERNAL CAPACITORS REQUIRED

The LMP201X does not need external capacitors. This eliminates the problems caused by capacitor leakage and dielectric absorption, which can cause delays of several seconds from turn-on until the amplifier's error has settled.

MORE BENEFITS

The LMP201X offers the benefits mentioned above and more. It has a rail-to-rail output and consumes only 950 μA of supply current while providing excellent DC and AC electrical performance. In DC performance, the LMP201X achieves 130 dB of CMRR, 120 dB of PSRR and 130 dB of open loop gain. In AC performance, the LMP201X provides 3 MHz of gain-bandwidth product and 4 V/ μs of slew rate.

HOW THE LMP201X WORKS

The LMP201X uses new, patented techniques to achieve the high DC accuracy traditionally associated with chopper-stabilized amplifiers without the major drawbacks produced by chopping. The LMP201X continuously monitors the input offset and corrects this error. The conventional chopping process produces many mixing products, both sums and differences, between the chopping frequency and the incoming signal frequency. This mixing causes large amounts of distortion, particularly when the signal frequency approaches the chopping frequency. Even without an incoming signal, the chopper harmonics mix with each other to produce even more trash. If this sounds unlikely or difficult to understand, look at the plot (Figure 2), of the output of a typical (MAX432) chopper-stabilized op amp. This is the output when there is no incoming signal, just the amplifier in a gain of -10 with the input grounded. The chopper is operating at about 150 Hz; the rest is mixing products. Add an input signal and the noise gets much worse. Compare this plot with Figure 3 of the LMP201X. This data was taken under the exact same conditions. The auto-zero action is visible at about 30 kHz but note the absence of mixing products at other frequencies. As a result, the LMP201X has very low distortion of 0.02% and very low mixing products.

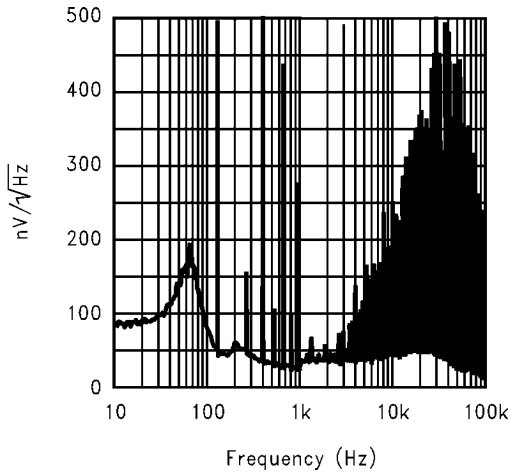

20071517

FIGURE 2. The Output of a Chopper Stabilized Op Amp (MAX432)

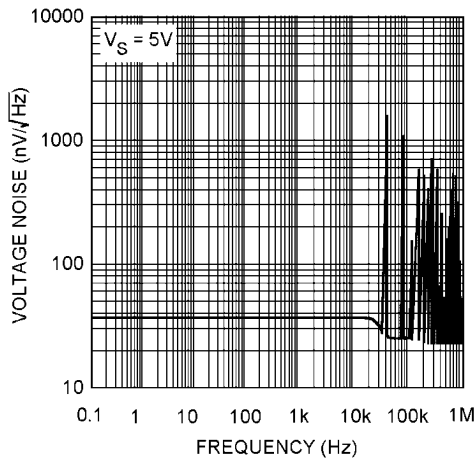

20071504

FIGURE 3. The Output of the LMP2011/LMP2012

INPUT CURRENTS

The LMP201X's input currents are different than standard bipolar or CMOS input currents in that it appears as a current flowing in one input and out the other. Under most operating conditions, these currents are in the picoamp level and will have little or no effect in most circuits. These currents tend to increase slightly when the common-mode voltage is near the minus supply. (See the typical curves.) At high temperatures such as 85°C, the input currents become larger, 0.5 nA typical, and are both positive except when the V_{CM} is near V^- . If operation is expected at low common-mode voltages and high temperature, do not add resistance in series with the inputs to balance the impedances. Doing this can cause an increase in offset voltage. A small resistance such as 1 k Ω can provide some protection against very large transients or overloads, and will not increase the offset significantly.

PRECISION STRAIN-GAUGE AMPLIFIER

This Strain-Gauge amplifier (Figure 4) provides high gain (1006 or ~ 60 dB) with very low offset and drift. Using the resistors' tolerances as shown, the worst case CMRR will be greater than 108 dB. The CMRR is directly related to the resistor mismatch. The rejection of common-mode error, at the output, is independent of the differential gain, which is set by R3. The CMRR is further improved, if the resistor ratio matching is improved, by specifying tighter-tolerance resistors, or by trimming.

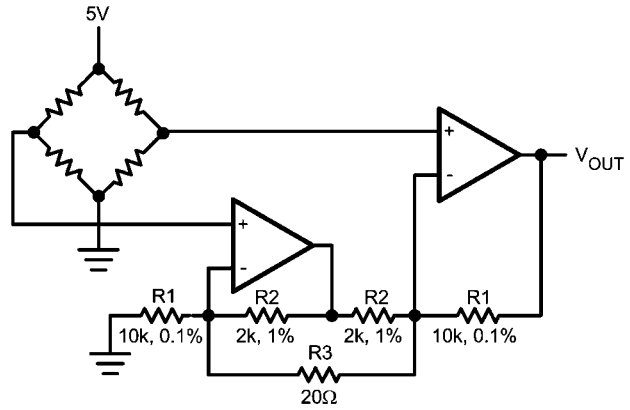

20071518

FIGURE 4. Precision Strain Gauge Amplifier

Extending Supply Voltages and Output Swing by Using a Composite Amplifier Configuration:

In cases where substantially higher output swing is required with higher supply voltages, arrangements like the ones shown in Figure 5 and Figure 6 could be used. These configurations utilize the excellent DC performance of the LMP201X while at the same time allow the superior voltage and frequency capabilities of the LM6171 to set the dynamic performance of the overall amplifier. For example, it is possible to achieve $\pm 12V$ output swing with 300 MHz of overall GBW ($A_V = 100$) while keeping the worst case output shift due to V_{OS} less than 4 mV. The LMP201X output voltage is kept at about mid-point of its overall supply voltage, and its input common mode voltage range allows the V^- terminal to be grounded in one case (Figure 5, inverting operation) and tied to a small non-critical negative bias in another (Figure 6, non-inverting operation). Higher closed-loop gains are also possible with a corresponding reduction in realizable bandwidth. Table 1 shows some other closed loop gain possibilities along with the measured performance in each case.

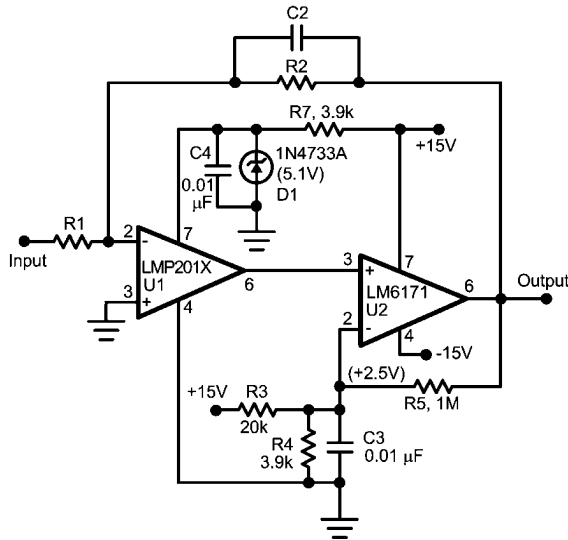

20071519

FIGURE 5. Composite Amplifier Configuration

TABLE 1. Composite Amplifier Measured Performance

A_V	R1 (Ω)	R2 (Ω)	C2 (pF)	BW (MHz)	SR (V/ μ s)	e_n p-p (mV _{PP})
50	200	10k	8	3.3	178	37
100	100	10k	10	2.5	174	70
100	1k	100k	0.67	3.1	170	70
500	200	100k	1.75	1.4	96	250
1000	100	100k	2.2	0.98	64	400

In terms of the measured output peak-to-peak noise, the following relationship holds between output noise voltage, e_n p-p, for different closed-loop gain, A_V , settings, where -3 dB Bandwidth is BW:

$$\frac{e_{npp1}}{e_{npp2}} = \sqrt{\frac{BW1}{BW2}} \cdot \frac{A_V1}{A_V2} \quad (1)$$

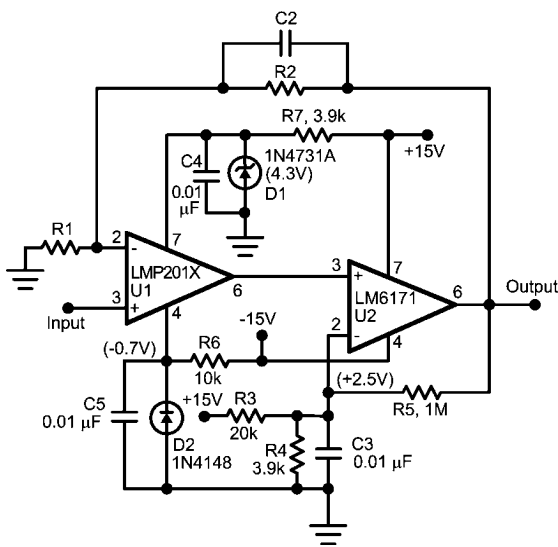

20071520

FIGURE 6. Composite Amplifier Configuration

It should be kept in mind that in order to minimize the output noise voltage for a given closed-loop gain setting, one could minimize the overall bandwidth. As can be seen from Equation 1 above, the output noise has a square-root relationship to the Bandwidth.

In the case of the inverting configuration, it is also possible to increase the input impedance of the overall amplifier, by raising the value of R1, without having to increase the feed-back resistor, R2, to impractical values, by utilizing a "Tee" network as feedback. See the LMC6442 data sheet (Application Notes section) for more details on this.

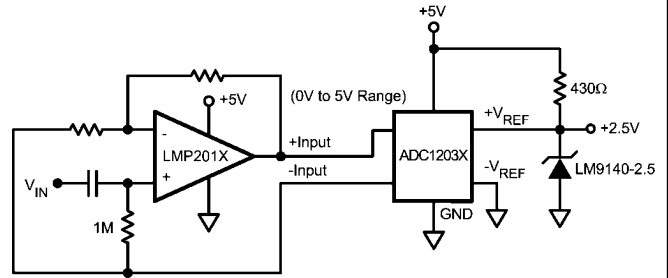

20071521

FIGURE 7. AC Coupled ADC Driver

LMP201X AS ADC INPUT AMPLIFIER

The LMP201X is a great choice for an amplifier stage immediately before the input of an ADC (Analog-to-Digital Converter), whether AC or DC coupled. See Figure 7 and Figure 8. This is because of the following important characteristics:

- A) Very low offset voltage and offset voltage drift over time and temperature allow a high closed-loop gain setting without introducing any short-term or long-term errors. For example, when set to a closed-loop gain of 100 as the analog input amplifier for a 12-bit A/D converter, the overall conversion error over full operation temperature and 30 years life of the part (operating at 50°C) would be less than 5 LSBs.
- B) Fast large-signal settling time to 0.01% of final value (1.4 μ s) allows 12 bit accuracy at 100 KHz or more sampling rate.
- C) No flicker (1/f) noise means unsurpassed data accuracy over any measurement period of time, no matter how long. Consider the following op amp performance, based on a typical low-noise, high-performance commercially-available device, for comparison:
 Op amp flatband noise = $8nV/\sqrt{Hz}$
 1/f corner frequency = 100 Hz
 $A_V = 2000$
 Measurement time = 100 sec
 Bandwidth = 2 Hz
 This example will result in about 2.2 mV_{PP} (1.9 LSB) of output noise contribution due to the op amp alone, compared to about 594 μ V_{PP} (less than 0.5 LSB) when that op amp is replaced with the LMP201X which has no 1/f contribution. If the measurement time is increased from 100 seconds to 1 hour, the improvement realized by using the LMP201X would be a factor of about 4.8 times (2.86 mV_{PP} compared to 596 μ V when LMP201X is used) mainly because the LMP201X accuracy is not compromised by increasing the observation time.
- D) Copper leadframe construction minimizes any thermo-couple effects which would degrade low level/high gain

data conversion application accuracy (see discussion under "The Benefits of the LMP201X" section above).

E) Rail-to-Rail output swing maximizes the ADC dynamic range in 5-Volt single-supply converter applications. Below are some typical block diagrams showing the LMP201X used as an ADC amplifier (Figure 7 and Figure 8).

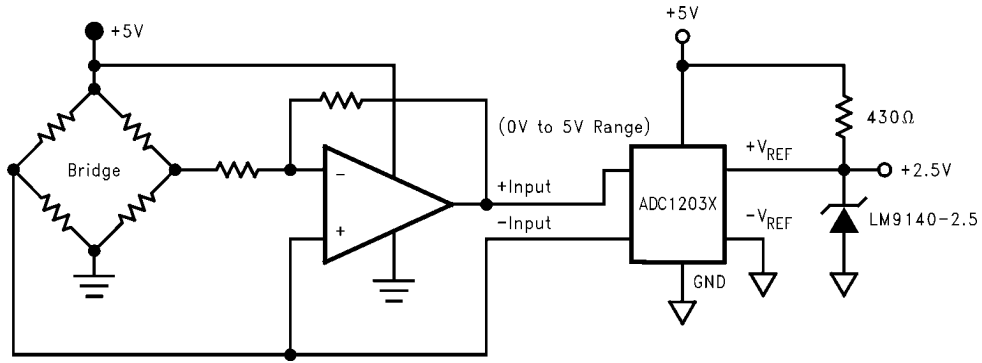

20071522

FIGURE 8. DC Coupled ADC Driver

Physical Dimensions inches (millimeters) unless otherwise noted

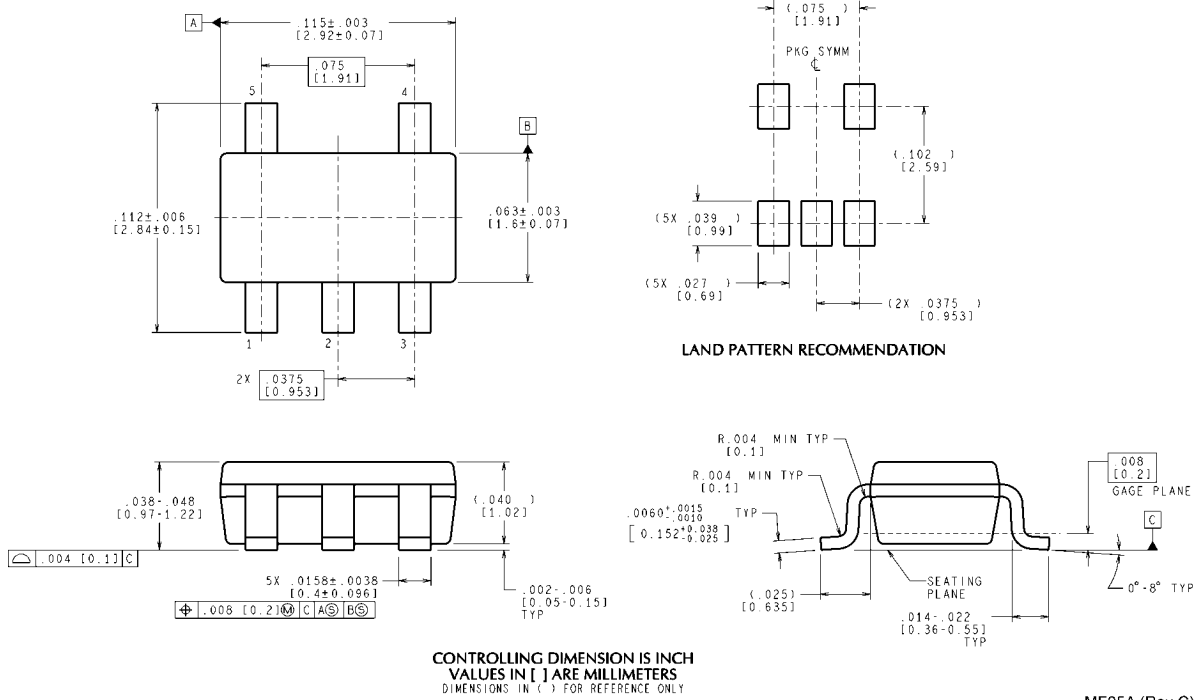

MF05A (Rev C)

**5-Pin SOT23
NS Package Number MF0A5**

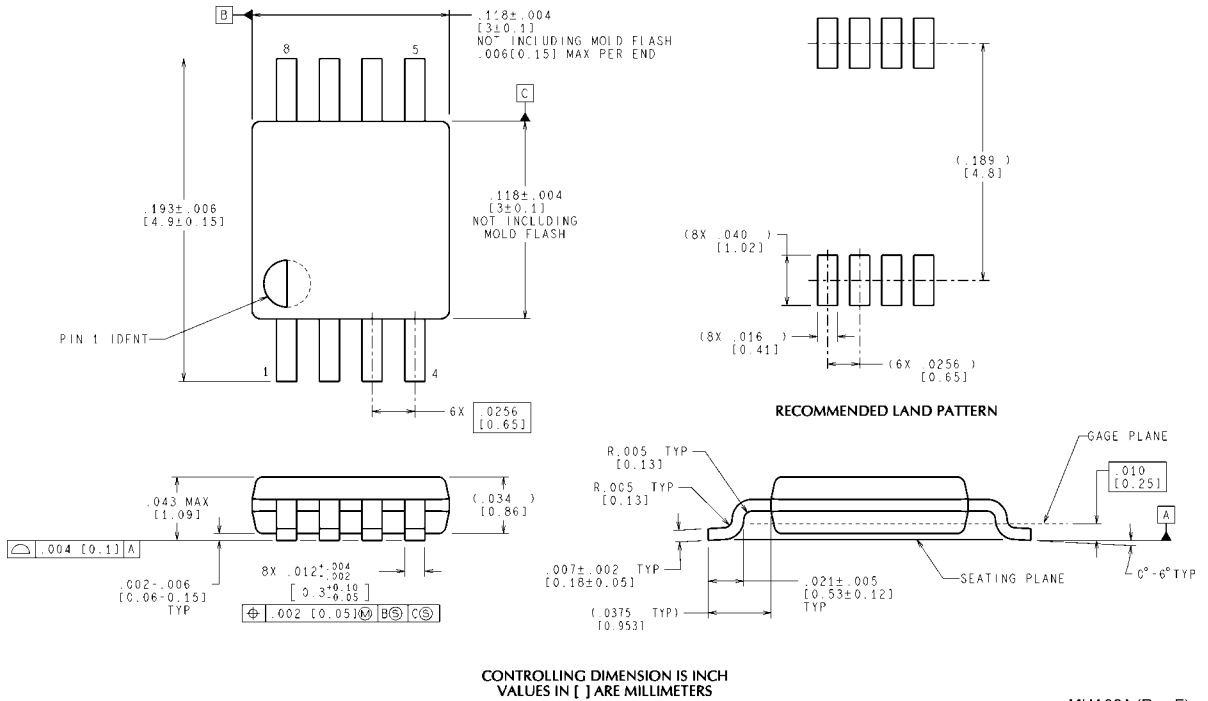

MUA08A (Rev F)

**8-Pin MSOP
NS Package Number MUA08A**

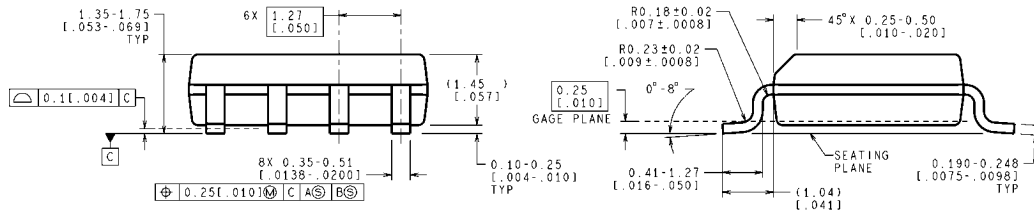
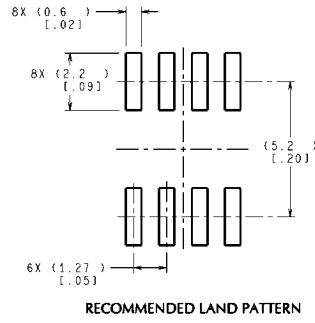
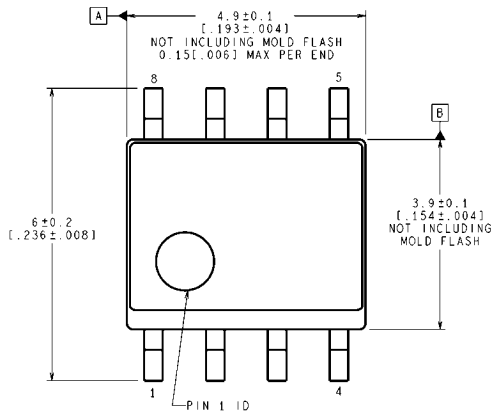

CONTROLLING DIMENSION IS MILLIMETER
VALUES IN [] ARE INCHES
DIMENSIONS IN () FOR REFERENCE ONLY

M08A (Rev L)

**8-Pin SOIC
NS Package Number M08A**

Notes

For more National Semiconductor product information and proven design tools, visit the following Web sites at:

Products		Design Support	
Amplifiers	www.national.com/amplifiers	WEBENCH	www.national.com/webench
Audio	www.national.com/audio	Analog University	www.national.com/AU
Clock Conditioners	www.national.com/timing	App Notes	www.national.com/appnotes
Data Converters	www.national.com/adc	Distributors	www.national.com/contacts
Displays	www.national.com/displays	Green Compliance	www.national.com/quality/green
Ethernet	www.national.com/ethernet	Packaging	www.national.com/packaging
Interface	www.national.com/interface	Quality and Reliability	www.national.com/quality
LVDS	www.national.com/lvds	Reference Designs	www.national.com/refdesigns
Power Management	www.national.com/power	Feedback	www.national.com/feedback
Switching Regulators	www.national.com/switchers		
LDOs	www.national.com/ldo		
LED Lighting	www.national.com/led		
PowerWise	www.national.com/powerwise		
Serial Digital Interface (SDI)	www.national.com/sdi		
Temperature Sensors	www.national.com/tempsensors		
Wireless (PLL/VCO)	www.national.com/wireless		

THE CONTENTS OF THIS DOCUMENT ARE PROVIDED IN CONNECTION WITH NATIONAL SEMICONDUCTOR CORPORATION ("NATIONAL") PRODUCTS. NATIONAL MAKES NO REPRESENTATIONS OR WARRANTIES WITH RESPECT TO THE ACCURACY OR COMPLETENESS OF THE CONTENTS OF THIS PUBLICATION AND RESERVES THE RIGHT TO MAKE CHANGES TO SPECIFICATIONS AND PRODUCT DESCRIPTIONS AT ANY TIME WITHOUT NOTICE. NO LICENSE, WHETHER EXPRESS, IMPLIED, ARISING BY ESTOPPEL OR OTHERWISE, TO ANY INTELLECTUAL PROPERTY RIGHTS IS GRANTED BY THIS DOCUMENT.

TESTING AND OTHER QUALITY CONTROLS ARE USED TO THE EXTENT NATIONAL DEEMS NECESSARY TO SUPPORT NATIONAL'S PRODUCT WARRANTY. EXCEPT WHERE MANDATED BY GOVERNMENT REQUIREMENTS, TESTING OF ALL PARAMETERS OF EACH PRODUCT IS NOT NECESSARILY PERFORMED. NATIONAL ASSUMES NO LIABILITY FOR APPLICATIONS ASSISTANCE OR BUYER PRODUCT DESIGN. BUYERS ARE RESPONSIBLE FOR THEIR PRODUCTS AND APPLICATIONS USING NATIONAL COMPONENTS. PRIOR TO USING OR DISTRIBUTING ANY PRODUCTS THAT INCLUDE NATIONAL COMPONENTS, BUYERS SHOULD PROVIDE ADEQUATE DESIGN, TESTING AND OPERATING SAFEGUARDS.

EXCEPT AS PROVIDED IN NATIONAL'S TERMS AND CONDITIONS OF SALE FOR SUCH PRODUCTS, NATIONAL ASSUMES NO LIABILITY WHATSOEVER, AND NATIONAL DISCLAIMS ANY EXPRESS OR IMPLIED WARRANTY RELATING TO THE SALE AND/OR USE OF NATIONAL PRODUCTS INCLUDING LIABILITY OR WARRANTIES RELATING TO FITNESS FOR A PARTICULAR PURPOSE, MERCHANTABILITY, OR INFRINGEMENT OF ANY PATENT, COPYRIGHT OR OTHER INTELLECTUAL PROPERTY RIGHT.

LIFE SUPPORT POLICY

NATIONAL'S PRODUCTS ARE NOT AUTHORIZED FOR USE AS CRITICAL COMPONENTS IN LIFE SUPPORT DEVICES OR SYSTEMS WITHOUT THE EXPRESS PRIOR WRITTEN APPROVAL OF THE CHIEF EXECUTIVE OFFICER AND GENERAL COUNSEL OF NATIONAL SEMICONDUCTOR CORPORATION. As used herein:

Life support devices or systems are devices which (a) are intended for surgical implant into the body, or (b) support or sustain life and whose failure to perform when properly used in accordance with instructions for use provided in the labeling can be reasonably expected to result in a significant injury to the user. A critical component is any component in a life support device or system whose failure to perform can be reasonably expected to cause the failure of the life support device or system or to affect its safety or effectiveness.

National Semiconductor and the National Semiconductor logo are registered trademarks of National Semiconductor Corporation. All other brand or product names may be trademarks or registered trademarks of their respective holders.

Copyright© 2008 National Semiconductor Corporation

For the most current product information visit us at www.national.com



National Semiconductor Americas Technical Support Center
Email: support@nsc.com
Tel: 1-800-272-9959

National Semiconductor Europe Technical Support Center
Email: europe.support@nsc.com
German Tel: +49 (0) 180 5010 771
English Tel: +44 (0) 870 850 4288

National Semiconductor Asia Pacific Technical Support Center
Email: ap.support@nsc.com

National Semiconductor Japan Technical Support Center
Email: jpn.feedback@nsc.com